

# Deep Learning Toolbox™

## Reference

*Mark Hudson Beale*

*Martin T. Hagan*

*Howard B. Demuth*

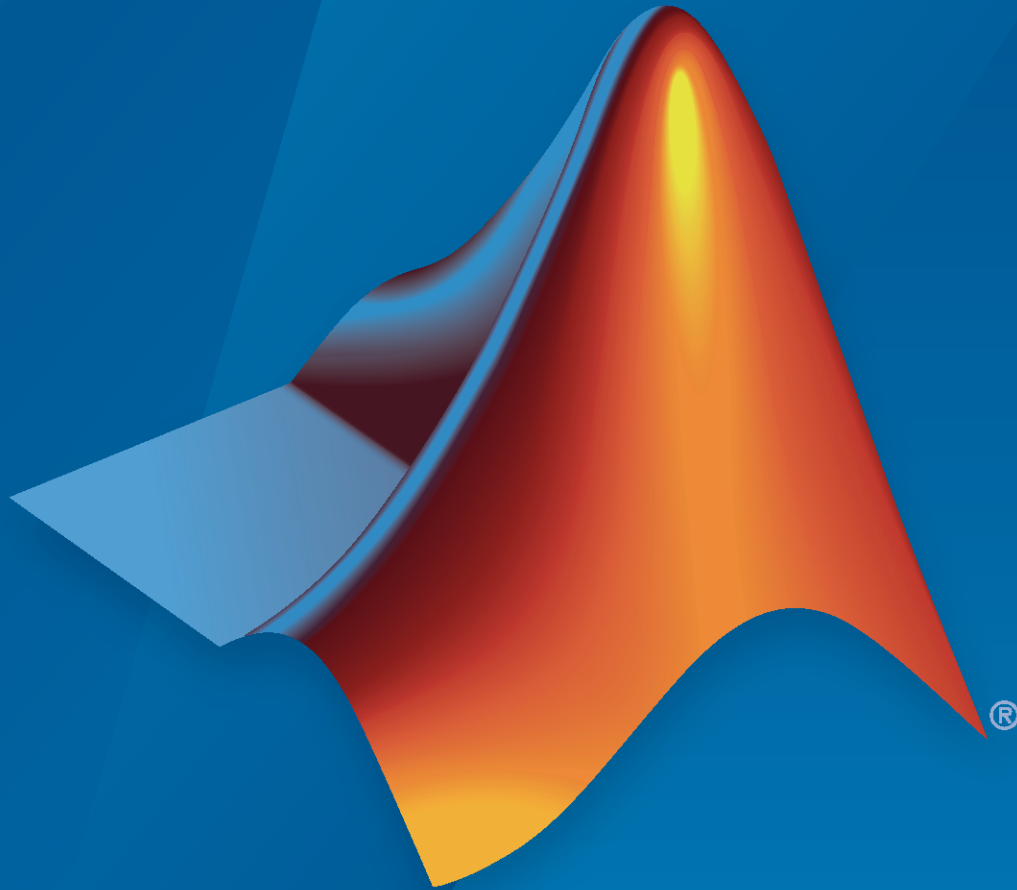

# MATLAB®

R2020a



## How to Contact MathWorks



Latest news: [www.mathworks.com](http://www.mathworks.com)  
Sales and services: [www.mathworks.com/sales\\_and\\_services](http://www.mathworks.com/sales_and_services)  
User community: [www.mathworks.com/matlabcentral](http://www.mathworks.com/matlabcentral)  
Technical support: [www.mathworks.com/support/contact\\_us](http://www.mathworks.com/support/contact_us)



Phone: 508-647-7000



The MathWorks, Inc.  
1 Apple Hill Drive  
Natick, MA 01760-2098

### *Deep Learning Toolbox™ Reference*

© COPYRIGHT 1992–2020 by The MathWorks, Inc.

The software described in this document is furnished under a license agreement. The software may be used or copied only under the terms of the license agreement. No part of this manual may be photocopied or reproduced in any form without prior written consent from The MathWorks, Inc.

FEDERAL ACQUISITION: This provision applies to all acquisitions of the Program and Documentation by, for, or through the federal government of the United States. By accepting delivery of the Program or Documentation, the government hereby agrees that this software or documentation qualifies as commercial computer software or commercial computer software documentation as such terms are used or defined in FAR 12.212, DFARS Part 227.72, and DFARS 252.227-7014. Accordingly, the terms and conditions of this Agreement and only those rights specified in this Agreement, shall pertain to and govern the use, modification, reproduction, release, performance, display, and disclosure of the Program and Documentation by the federal government (or other entity acquiring for or through the federal government) and shall supersede any conflicting contractual terms or conditions. If this License fails to meet the government's needs or is inconsistent in any respect with federal procurement law, the government agrees to return the Program and Documentation, unused, to The MathWorks, Inc.

### **Trademarks**

MATLAB and Simulink are registered trademarks of The MathWorks, Inc. See [www.mathworks.com/trademarks](http://www.mathworks.com/trademarks) for a list of additional trademarks. Other product or brand names may be trademarks or registered trademarks of their respective holders.

### **Patents**

MathWorks products are protected by one or more U.S. patents. Please see [www.mathworks.com/patents](http://www.mathworks.com/patents) for more information.

## Revision History

June 1992	First printing	
April 1993	Second printing	
January 1997	Third printing	
July 1997	Fourth printing	
January 1998	Fifth printing	Revised for Version 3 (Release 11)
September 2000	Sixth printing	Revised for Version 4 (Release 12)
June 2001	Seventh printing	Minor revisions (Release 12.1)
July 2002	Online only	Minor revisions (Release 13)
January 2003	Online only	Minor revisions (Release 13SP1)
June 2004	Online only	Revised for Version 4.0.3 (Release 14)
October 2004	Online only	Revised for Version 4.0.4 (Release 14SP1)
October 2004	Eighth printing	Revised for Version 4.0.4
March 2005	Online only	Revised for Version 4.0.5 (Release 14SP2)
March 2006	Online only	Revised for Version 5.0 (Release 2006a)
September 2006	Ninth printing	Minor revisions (Release 2006b)
March 2007	Online only	Minor revisions (Release 2007a)
September 2007	Online only	Revised for Version 5.1 (Release 2007b)
March 2008	Online only	Revised for Version 6.0 (Release 2008a)
October 2008	Online only	Revised for Version 6.0.1 (Release 2008b)
March 2009	Online only	Revised for Version 6.0.2 (Release 2009a)
September 2009	Online only	Revised for Version 6.0.3 (Release 2009b)
March 2010	Online only	Revised for Version 6.0.4 (Release 2010a)
September 2010	Online only	Revised for Version 7.0 (Release 2010b)
April 2011	Online only	Revised for Version 7.0.1 (Release 2011a)
September 2011	Online only	Revised for Version 7.0.2 (Release 2011b)
March 2012	Online only	Revised for Version 7.0.3 (Release 2012a)
September 2012	Online only	Revised for Version 8.0 (Release 2012b)
March 2013	Online only	Revised for Version 8.0.1 (Release 2013a)
September 2013	Online only	Revised for Version 8.1 (Release 2013b)
March 2014	Online only	Revised for Version 8.2 (Release 2014a)
October 2014	Online only	Revised for Version 8.2.1 (Release 2014b)
March 2015	Online only	Revised for Version 8.3 (Release 2015a)
September 2015	Online only	Revised for Version 8.4 (Release 2015b)
March 2016	Online only	Revised for Version 9.0 (Release 2016a)
September 2016	Online only	Revised for Version 9.1 (Release 2016b)
March 2017	Online only	Revised for Version 10.0 (Release 2017a)
September 2017	Online only	Revised for Version 11.0 (Release 2017b)
March 2018	Online only	Revised for Version 11.1 (Release 2018a)
September 2018	Online only	Revised for Version 12.0 (Release 2018b)
March 2019	Online only	Revised for Version 12.1 (Release 2019a)
September 2019	Online only	Revised for Version 13 (Release 2019b)
March 2020	Online only	Revised for Version 14 (Release 2020a)





**1** | Deep Learning Functions

**2** | Approximation, Clustering, and Control Functions



# Deep Learning Functions

---

# Deep Network Designer

Design, visualize, and train deep learning networks

## Description

The Deep Network Designer app lets you build, visualize, edit, and train deep learning networks. Using this app, you can:

- Load pretrained networks and edit them for transfer learning.
- Import and edit networks and build new networks.
- Drag and drop to add new layers and create new connections.
- View and edit layer properties.
- Analyze the network to ensure that the network architecture is defined correctly, and detect problems before training.
- Import image data for classification problems, and select augmentation options.
- Train networks for image classification tasks.
- Monitor training with plots of accuracy, loss, and validation metrics.
- Generate MATLAB® code for building and training networks.

After you finish designing a network, you can export it to the workspace, where you can save or train the network. For image classification problems, you can also train the network using Deep Network Designer. You can export the trained network and the results to the workspace.

## Open the Deep Network Designer App

- MATLAB Toolstrip: On the **Apps** tab, under **Machine Learning and Deep Learning**, click the app icon.
- MATLAB command prompt: Enter `deepNetworkDesigner`.

## Examples

### Select Pretrained Network

Examine a simple pretrained network in the Deep Network Designer app.

Open the app and select a pretrained network. You can also load a pretrained network by selecting the **Designer** tab and clicking **New**. If you need to download the network, then click **Install** for a link to Add-On Explorer.

---

**Tip** To get started, try choosing one of the faster networks, such as SqueezeNet or GoogLeNet. Once you have a feeling of which settings work well, try a more accurate network, such as Inception-v3 or a ResNet, and see if that improves your results. For more information on selecting a pretrained network, see “Pretrained Deep Neural Networks”.

---



In the **Designer** pane, visualize and explore the network. For a list of available networks and how to compare them, see “Pretrained Deep Neural Networks”.

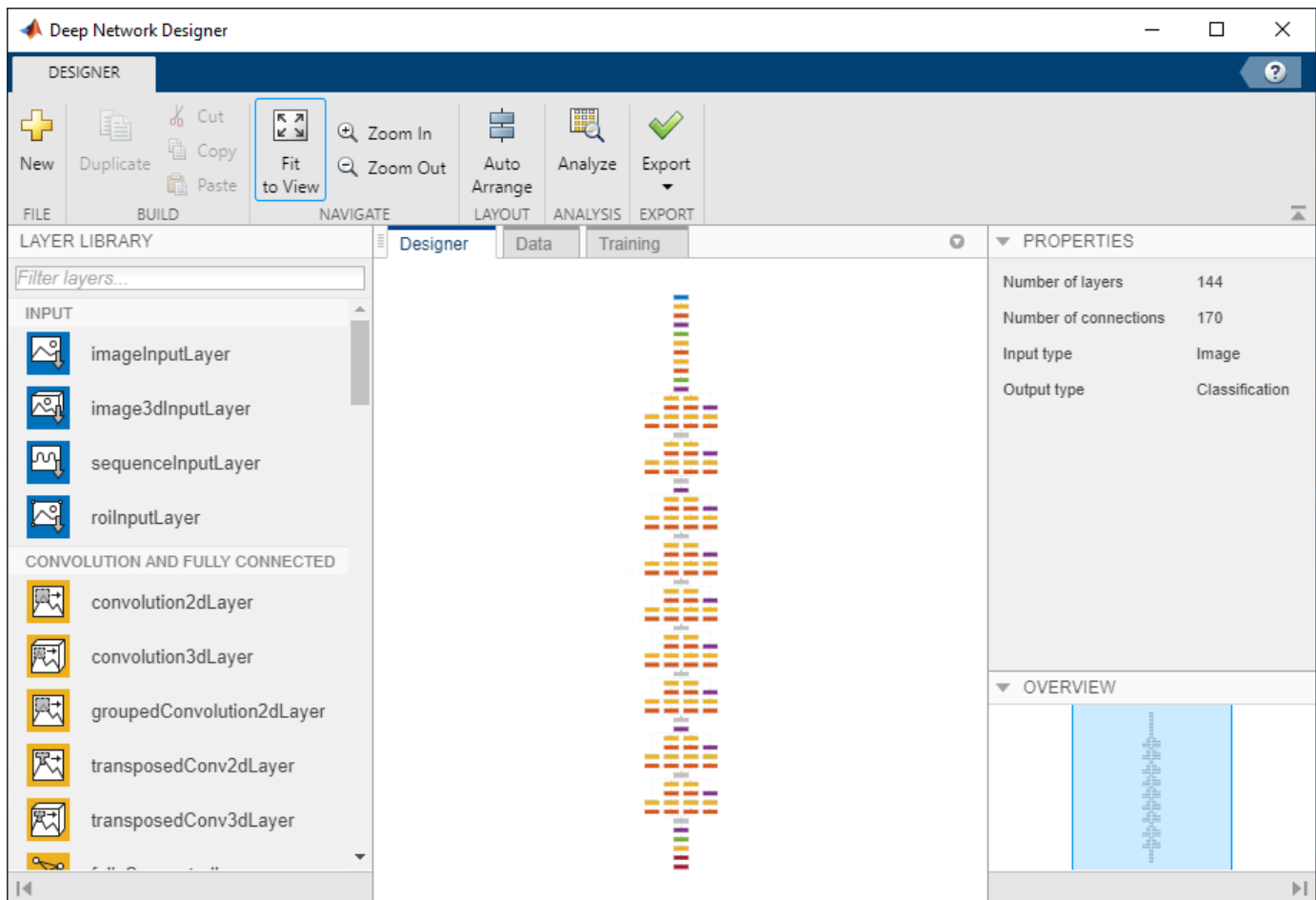

For information on constructing networks using Deep Network Designer, see “Build Networks with Deep Network Designer”.

### Import Data

Import image data into Deep Network Designer for training.

To import data into the app, on the **Data** tab, click **Import Data**.

You can import data from a folder with subfolders of images for each class, or from an `imageDatastore` in the workspace.

Deep Network Designer provides a selection of image augmentation options. You can effectively increase the amount of training data by applying randomized augmentation to your data. If you choose to augment your data, Deep Network Designer randomly perturbs the training data for each epoch. Each epoch then uses a slightly different data set.

Deep Network Designer provides the following augmentation options:

- Random reflection in the x-axis

- Random reflection in the y-axis
- Random rotation
- Random rescaling
- Random horizontal translation
- Random vertical translation

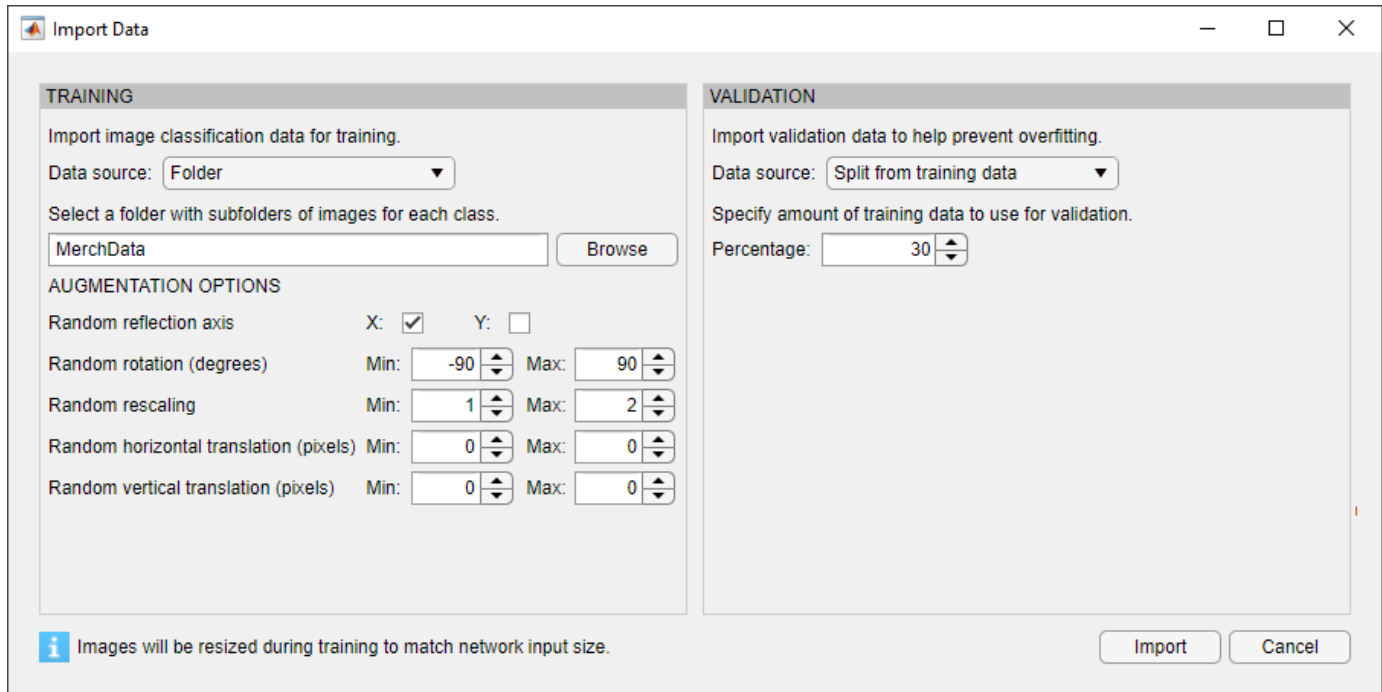

**Note** As some augmentations are inappropriate for particular data sets, by default, Deep Network Designer does not augment the data. For more information, see “Augment Images for Training with Random Geometric Transformations”.

Import validation data by selecting a folder, or importing an `imageDatastore` from the workspace. You can also choose to split the validation data from the training data. Validation data can help you to monitor performance and protect against overfitting.

After you select the location of the training data, specify the validation data, and set any augmentation options, click **Import** to import the data set.

### Edit Pretrained Network for Transfer Learning

Prepare a network for transfer learning by editing it in the Deep Network Designer app.

Transfer learning is the process of taking a pretrained deep learning network and fine-tuning it to learn a new task. You can quickly transfer learned features to a new task using a smaller number of training images. Transfer learning is therefore often faster and easier than training a network from scratch. To use a pretrained network for transfer learning, you must change the number of classes to match your new data set.

Open Deep Network Designer.

```
deepNetworkDesigner
```

Load a pretrained network by selecting it from the Deep Network Designer start page. Try selecting **SqueezeNet** from the list of pretrained networks. Click **Open** to load the network.

To prepare the network for transfer learning, replace the last learnable layer and the final classification layer.

- If the last learnable layer is a 2-D convolutional layer (for example, the 'conv10' layer in SqueezeNet):
  - Drag a new `convolution2dLayer` onto the canvas. Set the `NumFilters` property to the new number of classes and `FilterSize` to 1,1.
  - Delete the last `convolution2dLayer` and connect your new layer instead.

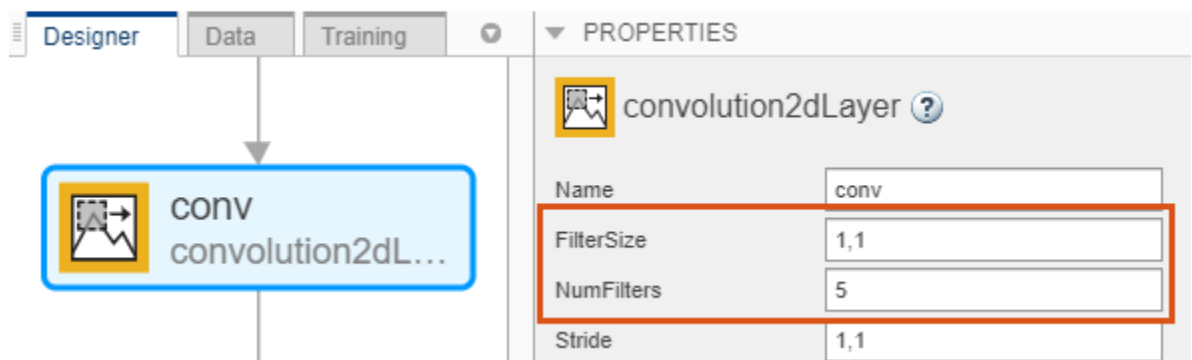

- If the last learnable layer is a fully connected layer (most pretrained networks, for example, GoogLeNet):
  - Drag a new `fullyConnectedLayer` onto the canvas and set the `OutputSize` property to the new number of classes.
  - Delete the last `fullyConnectedLayer` and connect your new layer instead.

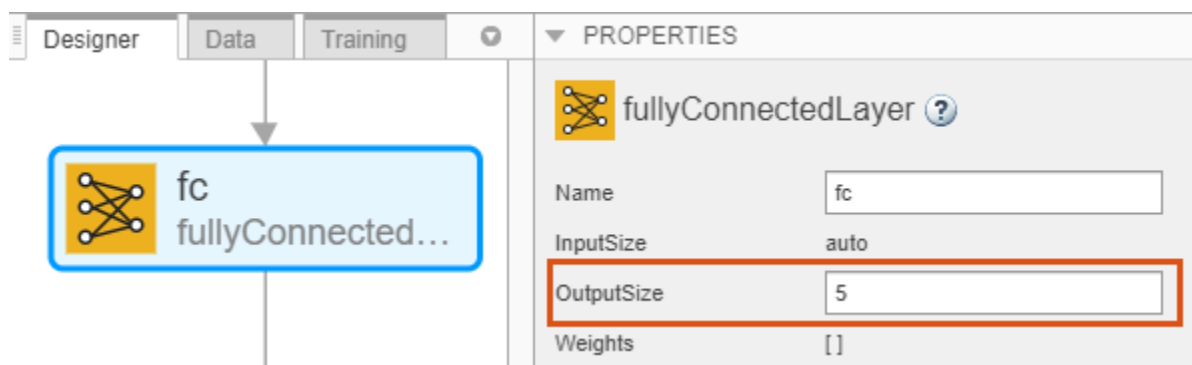

Next, delete the classification output layer. Then, drag a new `classificationLayer` onto the canvas and connect it instead. The default settings for the output layer mean it will learn the number of classes during training.



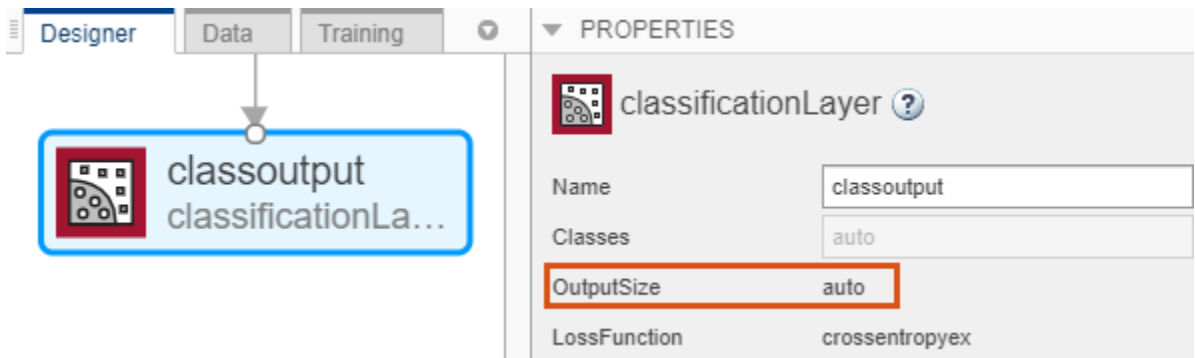

To check that the network is ready for training, on the **Designer** tab, click **Analyze**.

To train the network, select the **Training** tab. For more information, see “Transfer Learning with Deep Network Designer”.

### Get Help on Layer Properties

For help understanding and editing layer properties, click the help icon next to the layer name.

On the **Designer** pane, select a layer to view and edit the properties. Click the help icon next to the layer name for more information about the properties of the layer.

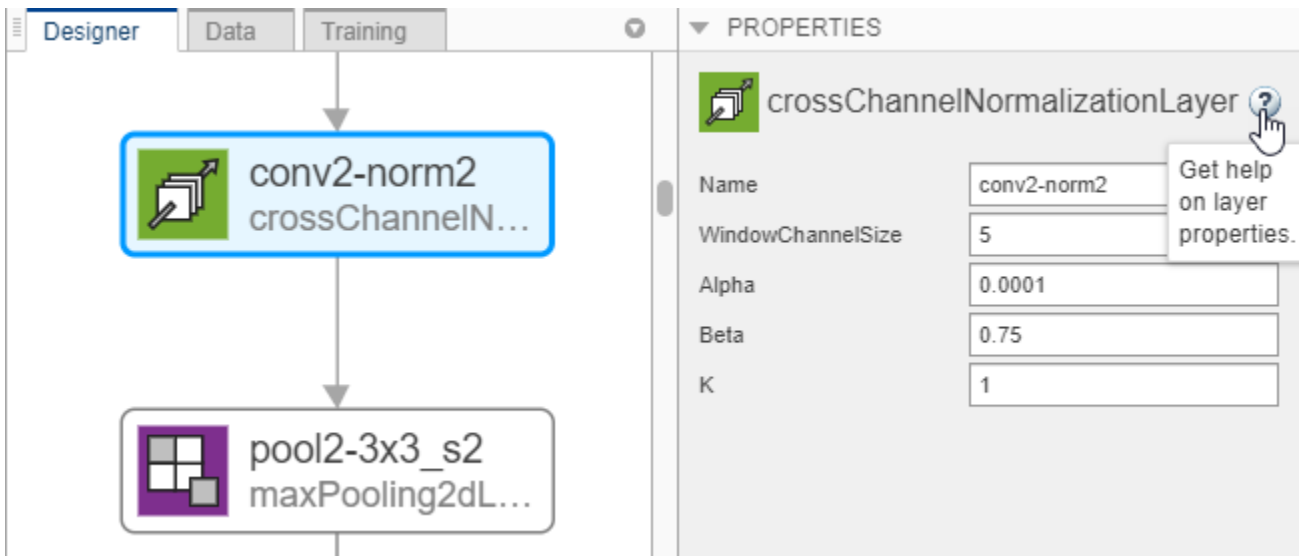

For more information about layer properties, see “List of Deep Learning Layers”.

### Train Network

Train an image classification network in the Deep Network Designer app.

To train a network on image data imported into Deep Network Designer, on the **Training** tab, click **Train**. If you require greater control over the training, click **Training Options** to select the training settings. For more information about selecting training options, see `trainingOptions`.

For an example showing how to train an image classification network, see “Transfer Learning with Deep Network Designer”.

To train a network on other types of data, select the **Designer** tab and click **Export** to export the initial network architecture. You can then programmatically train the network. For a simple example, see “Create Simple Sequence Classification Network Using Deep Network Designer”.

## Export Network Architecture

Export the network architecture, created in Deep Network Designer, to the workspace.

- To export the network architecture with the initial weights, on the **Designer** tab, click **Export**.
- To export the network architecture with the trained weights, on the **Training** tab, click **Export**.

## Generate MATLAB Code for Creating Network Architecture

To recreate the network layers you create in the Deep Network Designer app, generate MATLAB code.

To recreate the network layers, on the **Designer** tab, select **Export > Generate Code**.

Alternatively, you can recreate your network, including any learnable parameters, by selecting **Export > Generate Code with Initial Parameters**.

After generating a script you can perform the following tasks.

- To recreate the network layers created in the app, run the script.
- To train the network, run the script and then supply the layers to the `trainNetwork` function.
- Examine the code to learn how to create and connect layers programmatically.
- To modify the layers, edit the code. You can also run the script and import the network back into the app for editing.

For more information, see “Generate MATLAB Code to Recreate Network Layers”.

## Generate MATLAB Code for Training

To recreate the data import and training you perform in the Deep Network Designer app, generate MATLAB code.

To recreate the data import and training, on the **Training** tab, select **Export > Generate Code for Training**.

After generating a script you can perform the following tasks.

- To recreate the network layers and the training performed in the app, run the script.
- Examine the code to learn how to programmatically import data, and construct and train a network.
- Modify the code to try different network architectures and training options, and see how they affect the results.

For more information, see “Generate MATLAB Code to Train Network”.

- “Transfer Learning with Deep Network Designer”
- “Build Networks with Deep Network Designer”
- “Create Simple Sequence Classification Network Using Deep Network Designer”
- “Generate MATLAB Code from Deep Network Designer”
- “List of Deep Learning Layers”

## Tips

To train multiple networks and compare the results, try **Experiment Manager**.

## See Also

### Functions

**Experiment Manager** | `analyzeNetwork` | `trainNetwork` | `trainingOptions`

### Topics

“Transfer Learning with Deep Network Designer”

“Build Networks with Deep Network Designer”

“Create Simple Sequence Classification Network Using Deep Network Designer”

“Generate MATLAB Code from Deep Network Designer”

“List of Deep Learning Layers”

### Introduced in R2018b

# Experiment Manager

Design and run experiments to train and compare deep learning networks

## Description

The Experiment Manager app enables you to create a deep learning experiment to train networks under various initial conditions and compare the results. For example, you can use deep learning experiments to:

- Sweep through a range of hyperparameter values to train a deep network.
- Compare the results of using different data sets to train a network.
- Test different deep network architectures by reusing the same set of training data on several networks.

Experiment Manager provides visualization tools such as training plots and confusion matrices, filters to refine your experiment results, and the ability to define custom metrics to evaluate your results. To improve reproducibility, every time that you run an experiment, Experiment Manager stores a copy of the experiment definition. You can access past experiment definitions to keep track of the hyperparameter combinations that produce each of your results.

Experiment Manager organizes your experiments and results in a project (MATLAB).

- You can store several experiments in the same project.
- Each experiment contains a set of results for each time that you run the experiment.
- Each set of results consists of one or more trials corresponding to a different combination of hyperparameters.

The **Experiment Browser** pane displays the hierarchy of experiments and results in the project. For instance, this project has two experiments, each of which has several sets of results. To open the configuration for an experiment and view its results, double-click the name of an experiment or a set of results.

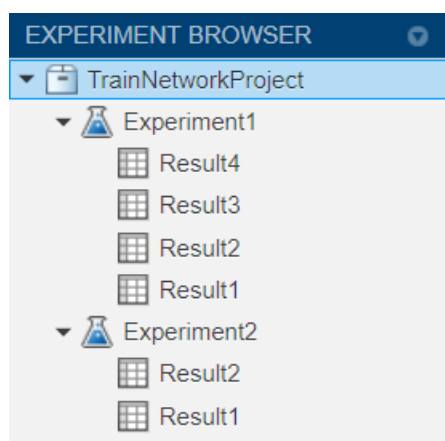

## Open the Experiment Manager App

- MATLAB Toolstrip: On the **Apps** tab, under **Machine Learning and Deep Learning**, click the app icon.
- MATLAB command prompt: Enter `experimentManager`.

## Examples

### Sweep Hyperparameters to Train a Classification Network

This example shows how to use the default experiment setup function to train an image classification network by sweeping hyperparameters. The experiment uses the Digits data set. For more information on this data set, see “Image Data Sets”.

Open the example to load a project with a preconfigured experiment that you can inspect and run. To open the experiment, in the **Experiment Browser**, double-click the name of the experiment (Experiment1).

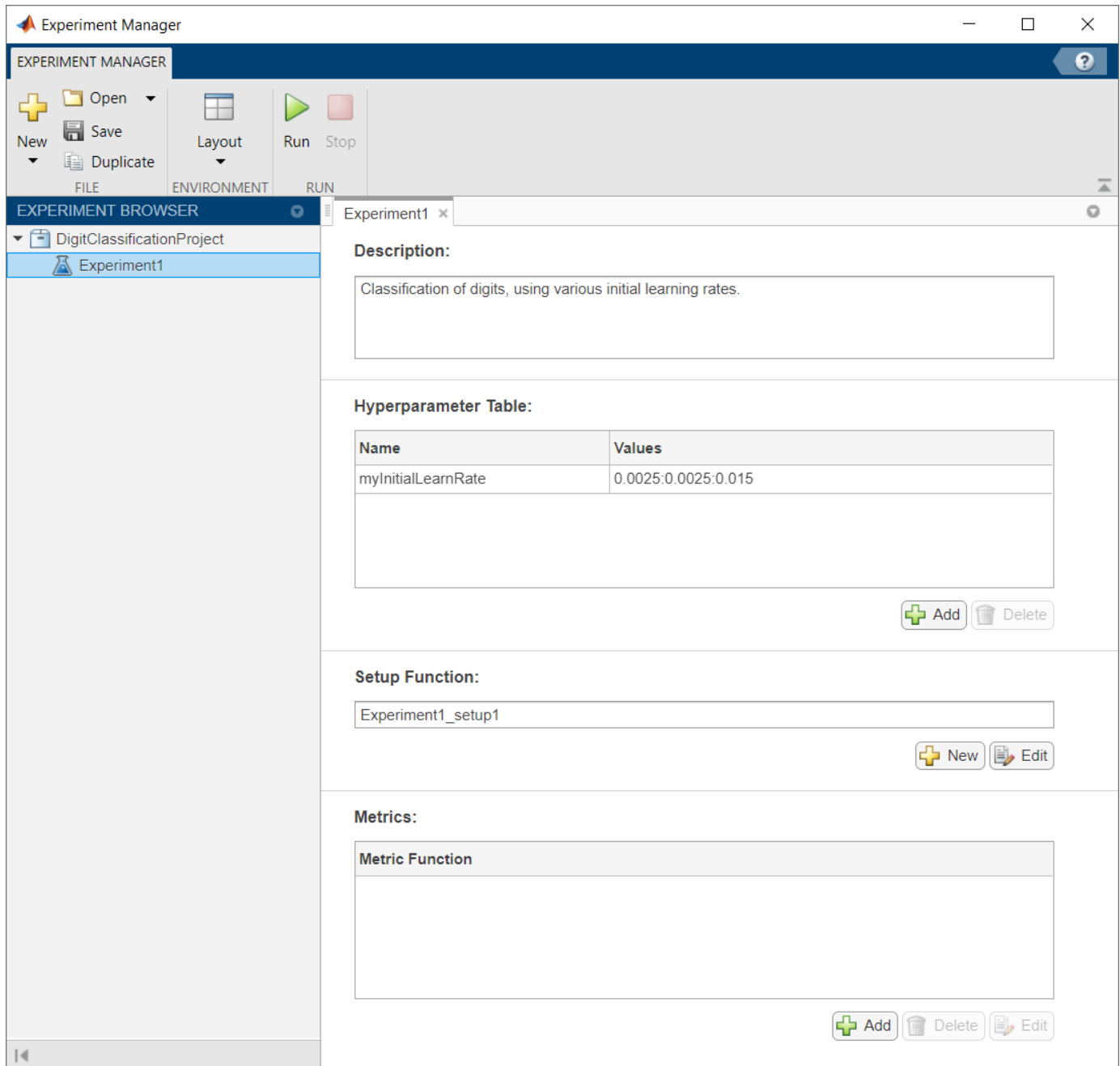

Alternatively, you can configure the experiment yourself by following these steps.

1. Open Experiment Manager.
2. Click **New > Project** and select the location and name for a new project. Experiment Manager opens a new experiment in the project. The **Experiment** pane displays the description, hyperparameter table, setup function, and metrics that define the experiment.
3. In the **Description** box, enter a description of the experiment:  
Classification of digits, using various initial learning rates.

4. In the **Hyperparameter Table**, replace the value of `myInitialLearnRate` with `0.0025:0.0025:0.015`.

5. Under **Setup Function**, click **Edit**. The setup function opens in MATLAB Editor. The setup function specifies the training data, network architecture, and training options for the experiment. By default, the template for the setup function has three sections.

- **Load Image Data** defines image datastores containing the training and validation data for the experiment. The data consists of 10,000 28-by-28 pixel grayscale images of digits from 0 to 9, categorized by the digit they represent.
- **Define Network Architecture** defines the architecture for a simple convolutional neural network for deep learning classification.
- **Specify Training Options** defines a `trainingOptions` object for the experiment. By default, the template loads the values for the training option 'InitialLearnRate' from the `myInitialLearnRate` entry in the hyperparameter table.

In Experiment Manager, click **Run**. Experiment Manager trains the network defined by the setup function six times. Each trial uses one of the learning rates specified in the hyperparameter table. A table of results displays the accuracy and loss for each trial.

Trial	Status	Progress	Elapsed Time	myInitialLearnRate	Training Accuracy (%)	Training Loss	Validation Accuracy (%)	Validation Loss
1	Complete	100.0%	0 hr 1 min 31 sec	0.0025	100.0000	0.0742	60.0000	1.2523
2	Complete	100.0%	0 hr 1 min 10 sec	0.0050	100.0000	0.0302	62.3600	1.3163
3	Running	57.6%	0 hr 0 min 42 sec	0.0075				
4	Queued	0.0%		0.0100				
5	Queued	0.0%		0.0125				
6	Queued	0.0%		0.0150				

While the experiment is running, click **Training Plot** to display the training plot and track the progress of each trial. You can also monitor the training progress in the MATLAB Command Window.

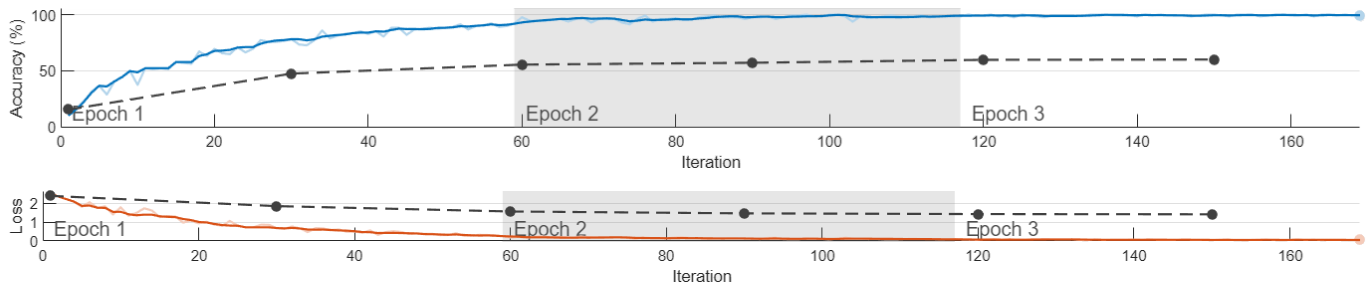

Click **Confusion Matrix** to display the confusion matrix for the validation data in each completed trial.

	168	10	9	7	15	9	13	10	4	5			
1		215	9	12	2	6		6				67.2%	32.8%
2	3	22	119	29	15	3	5	21	33			86.0%	14.0%
3			5	156	25	23		3	29	9		47.6%	52.4%
4		23			193		5		29			62.4%	37.6%
5		34	2	39		152	4		6	13		77.2%	22.8%
6	3	84	25	18	13	2	77		28			60.8%	39.2%
7	1	18	6		1				215	9		30.8%	69.2%
8	3	46	37	50	6	8	11	7	65	17		86.0%	14.0%
9		26		7	35	4	1		37	140		26.0%	74.0%
												56.0%	44.0%
	94.4%	45.0%	56.1%	49.1%	63.3%	73.4%	66.4%	82.1%	27.1%	76.1%			
	5.6%	55.0%	43.9%	50.9%	36.7%	26.6%	33.6%	17.9%	72.9%	23.9%			
	0	1	2	3	4	5	6	7	8	9			

When the experiment finishes, you can sort the table by column or filter trials by using the **Filters** pane. For more information, see “Sort and Filter Experiment Results” on page 1-18.

To test the performance of an individual trial, export the trained network or the training information for the trial. On the **Experiment Manager** tab, select **Export > Trained Network** or **Export > Training Information**, respectively. For more information, see “Output Arguments” on page 1-848.

To close the experiment, in the **Experiment Browser**, right-click the name of the project and select **Close Project**. Experiment Manager saves your results and closes all of the experiments contained in the project.

### Sweep Hyperparameters to Train Regression Network

This example shows how to configure an experiment to train an image regression network by sweeping hyperparameters. The experiment uses the Digits data set. For more information on this data set, see “Image Data Sets”.

Open the example to load a project with a preconfigured experiment that you can inspect and run. To open the experiment, in the **Experiment Browser**, double-click the name of the experiment (Experiment1).



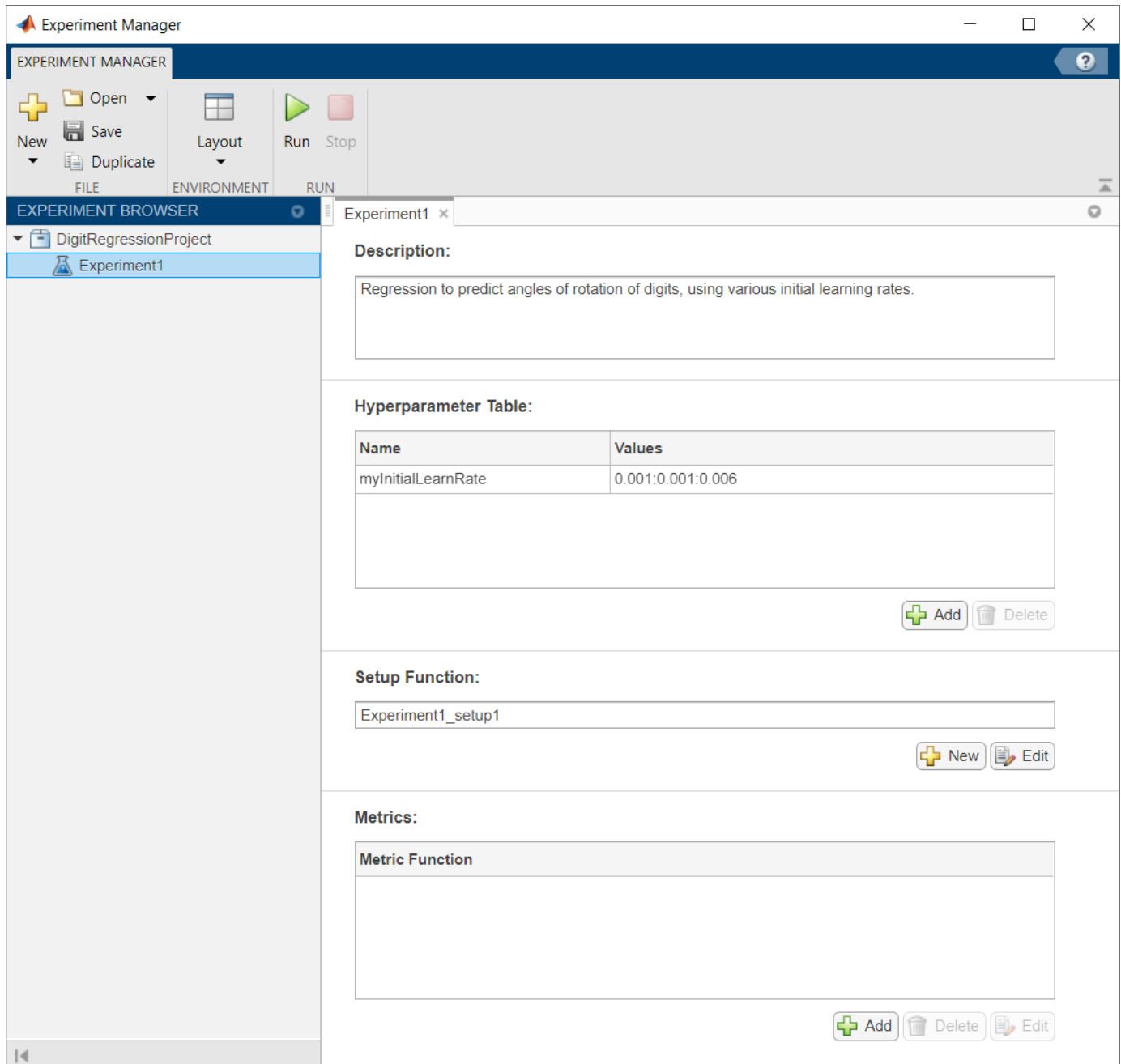

Alternatively, you can configure the experiment yourself by following these steps.

1. Open Experiment Manager.
2. Click **New > Project** and select the location and name for a new project. Experiment Manager opens a new experiment in the project. The **Experiment** pane displays the description, hyperparameter table, setup function, and metrics that define the experiment.
3. In the **Description** box, enter a description of the experiment:

Regression model to predict angles of rotation of digits, using various initial learning rates.

4. In the **Hyperparameter Table**, replace the value of `myInitialLearnRate` with `0.001:0.001:0.006`.

5. Under **Setup Function**, click **Edit**. The setup function opens in MATLAB Editor.

- Modify the setup function signature to return four outputs. These outputs are used to call the `trainNetwork` function to train a network for image regression problems.

```
function [XTrain,YTrain,layers,options] = Experiment1_setup1(params)
```

- Modify the **Load Image Data** section of the setup function to define the training and validation data for the experiment as 4-D arrays. The training and validation data sets each contain 5000 images of digits from 0 to 9. The regression values correspond to the angles of rotation of the digits. Be sure to delete all of the existing code in this section of the setup function.

```
[XTrain,~,YTrain] = digitTrain4DArrayData;  
[XValidation,~,YValidation] = digitTest4DArrayData;
```

- Modify the **Define Network Architecture** section of the setup function to define a convolutional neural network for regression. Be sure to delete all of the existing code in this section of the setup function.

```
layers = [  
    imageInputLayer([28 28 1])  
    convolution2dLayer(3,8, 'Padding', 'same')  
    batchNormalizationLayer  
    reluLayer  
    averagePooling2dLayer(2, 'Stride', 2)  
    convolution2dLayer(3,16, 'Padding', 'same')  
    batchNormalizationLayer  
    reluLayer  
    averagePooling2dLayer(2, 'Stride', 2)  
    convolution2dLayer(3,32, 'Padding', 'same')  
    batchNormalizationLayer  
    reluLayer  
    convolution2dLayer(3,32, 'Padding', 'same')  
    batchNormalizationLayer  
    reluLayer  
    dropoutLayer(0.2)  
    fullyConnectedLayer(1)  
    regressionLayer];
```

- Modify the **Specify Training Options** section of the setup function to use the validation data in the 4-D arrays `XValidation` and `YValidation`. This section of the setup function loads the values for the training option `'InitialLearnRate'` from the `myInitialLearnRate` entry in the hyperparameter table.

```
options = trainingOptions('sgdm', ...  
    'MaxEpochs',5, ...  
    'ValidationData',{XValidation,YValidation}, ...  
    'ValidationFrequency',30, ...  
    'InitialLearnRate',params.myInitialLearnRate);
```

In Experiment Manager, click **Run**. Experiment Manager trains the network defined by the setup function six times. Each trial uses one of the learning rates specified in the hyperparameter table. A table of results displays the root mean squared error (RMSE) and loss for each trial.

Trial	Status	Progress	Elapsed Time	myInitialLearnRate	Training RMSE	Training Loss	Validation RMSE	Validation Loss
1	Complete	100.0%	0 hr 0 min 40 sec	0.0010	7.2099	25.9910	7.4390	27.6694
2	Complete	100.0%	0 hr 1 min 0 sec	0.0020	9.6156	46.2302	9.2450	42.7348
3	Complete	100.0%	0 hr 1 min 0 sec	0.0030	10.1454	51.4646	9.5572	45.6702
4	Running	77.4%	0 hr 0 min 52 sec	0.0040				
5	Queued	0.0%		0.0050				
6	Queued	0.0%		0.0060				

While the experiment is running, click **Training Plot** to display the training plot and track the progress of each trial. You can also monitor the training progress in the MATLAB Command Window.

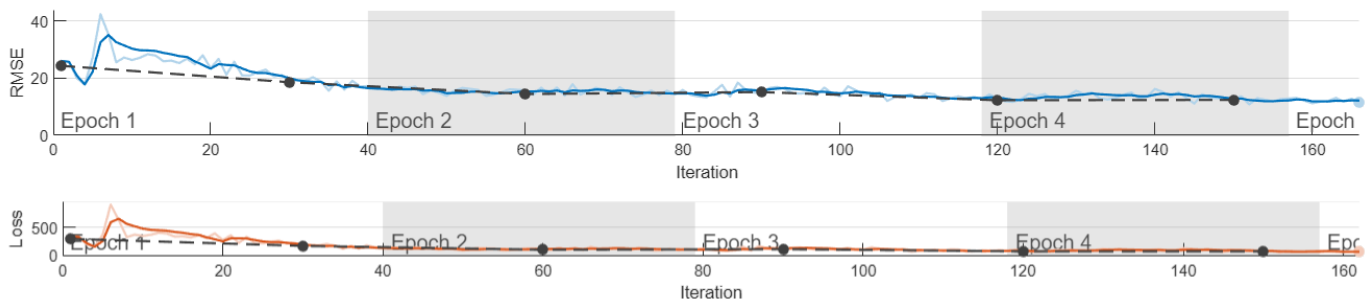

When the experiment finishes, you can sort the table by column or filter trials by using the **Filters** pane. For more information, see “Sort and Filter Experiment Results” on page 1-18.

To test the performance of an individual trial, export the trained network or the training information for the trial. On the **Experiment Manager** tab, select **Export > Trained Network** or **Export > Training Information**, respectively. For more information, see “Output Arguments” on page 1-848.

To close the experiment, in the **Experiment Browser**, right-click the name of the project and select **Close Project**. Experiment Manager saves your results and closes all of the experiments contained in the project.

## Configure Deep Learning Experiment

This example shows how to set up an experiment using the Experiment Manager app.

Experiment definitions consist of a description, a hyperparameter table, a setup function, and (optionally) a collection of metric functions to evaluate the results of the experiment.

In the **Description** box, enter a description of the experiment.

In the **Hyperparameter Table**, specify names and values of the hyperparameters used in the experiment. When you run the experiment, Experiment Manager sweeps through the hyperparameter values and trains the network multiple times. Each trial uses a different combination of the hyperparameter values specified in the table. Specify hyperparameters as scalars or vectors with numeric, logical, or string values. For example, these are valid hyperparameter specifications:

- 0.01
- 0.01:0.01:0.05
- [0.01 0.02 0.04 0.08]
- ["sgdm" "rmsprop" "adam"]

The **Setup Function** configures the training data, network architecture, and training options for the experiment. The input to the setup function is a `struct` with fields from the hyperparameter table. The output of the setup function must match the input of the `trainNetwork` function. This table lists the supported signatures for the setup function.

Goal of Experiment	Setup Function Signature
Train a network for image classification problems using the image datastore <code>imds</code> to store the input image data.	<code>function [imds, layers, options] = Experiment_setup(parameters, imds, layers, options);</code> ... <code>end</code>
Train a network using the datastore <code>ds</code> .	<code>function [ds, layers, options] = Experiment_setup(parameters, ds, layers, options);</code> ... <code>end</code>
Train a network for image classification and regression problems using the numeric arrays <code>X</code> to store the predictor variables and <code>Y</code> to store the categorical labels or numeric responses.	<code>function [X, Y, layers, options] = Experiment_setup(parameters, X, Y, layers, options);</code> ... <code>end</code>
Train a network for sequence classification and regression problems using <code>sequences</code> to store sequence or time-series predictors and <code>Y</code> to store the responses.	<code>function [sequences, Y, layers, options] = Experiment_setup(parameters, sequences, Y, layers, options);</code> ... <code>end</code>
Train a network for classification and regression problems using the table <code>tbl</code> to store numeric data or file paths to the data.	<code>function [tbl, layers, options] = Experiment_setup(parameters, tbl, layers, options);</code> ... <code>end</code>
Train a network for classification and regression problems using <code>responseName</code> to specify the response variables in <code>tbl</code> .	<code>function [tbl, responseName, layers, options] = Experiment_setup(parameters, tbl, responseName, layers, options);</code> ... <code>end</code>

**Note** Experiment Manager does not support the 'multi-gpu' or 'parallel' values for the training option 'ExecutionEnvironment'.

The **Metrics** section specifies functions to evaluate the results of the experiment. The input to a metric function is a `struct` with three fields:

- `trainedNetwork` is the `SeriesNetwork` object or `DAGNetwork` object returned by the `trainNetwork` function. For more information, see [Trained Network on page 1-0](#).
- `trainingInfo` is a `struct` containing the training information returned by the `trainNetwork` function. For more information, see [Training Information on page 1-0](#).
- `parameters` is a `struct` with fields from the hyperparameter table.

The output of a metric function must be a scalar number, a logical value, or a string.

## Sort and Filter Experiment Results

This example shows how to compare the results of running an experiment.

When you run an experiment, Experiment Manager trains the network defined by the setup function multiple times. Each trial uses a different combination of hyperparameters. When the experiment finishes, a table displays training and validation metrics (such as accuracy, RMSE, and loss) for each trial. To compare the results of an experiment, you can use the training and validation metrics to sort the results table and filter trials.

To sort the trials in the results table, use the drop-down menu for the column corresponding to a training or validation metric.

- 1 Point to the header of a column by which you want to sort.
- 2 Click the triangle icon.
- 3 Select **Sort in Ascending Order** or **Sort in Descending Order**.

Trial	Status	Progress	Elapsed Time	myInitialLearnRate	Training Accuracy (%)	Training Loss	Validation Accuracy (%)	Validation Loss
1	Complete	100.0%	0 hr 1 min 31 sec	0.0025	100.0000	0.0742	60.00	1.4306
2	Complete	100.0%	0 hr 1 min 10 sec	0.0050	100.0000	0.0302	62.36	1.5141
3	Complete	100.0%	0 hr 1 min 23 sec	0.0075	100.0000	0.0182	62.80	1.5513
4	Complete	100.0%	0 hr 1 min 11 sec	0.0100	100.0000	0.0137	63.9600	1.4306
5	Complete	100.0%	0 hr 1 min 7 sec	0.0125	100.0000	0.0114	63.7200	1.5141
6	Complete	100.0%	0 hr 1 min 7 sec	0.0150	100.0000	0.0093	63.7200	1.5513

To filter trials from the results table, use the **Filters** pane.



- 1 On the **Experiment Manager** tab, select **Filters**.

The **Filters** pane shows histograms for the numeric metrics in the results table. To remove a histogram from the **Filters** pane, in the results table, open the drop-down menu for the corresponding column and clear the **Show Filter** check box.

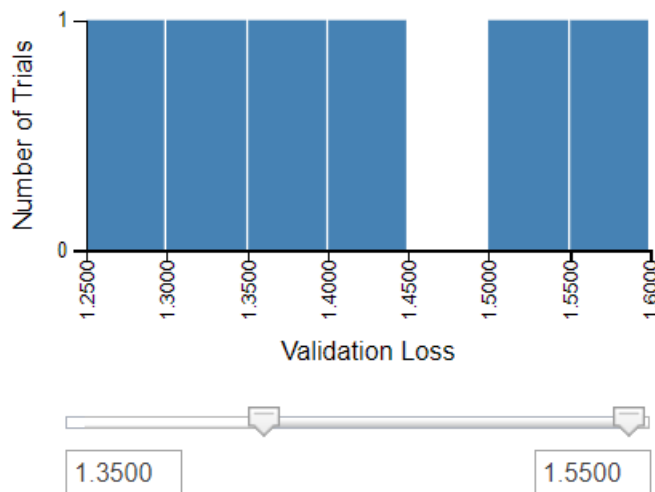
- 2 Adjust the sliders under the histogram for the training or validation metric by which you want to filter.

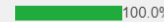

The results table shows only the trials with a metric value in the selected range.

Trial	Status	Progress	Elapsed Time	myInitialLearnRate	Training Accuracy (%)	Training Loss	Validation Accuracy (%)	Validation Loss
3	Complete	 100.0%	0 hr 1 min 23 sec	0.0075	100.0000	0.0182	62.8000	1.3878
4	Complete	 100.0%	0 hr 1 min 11 sec	0.0100	100.0000	0.0137	63.9600	1.4306
5	Complete	 100.0%	0 hr 1 min 7 sec	0.0125	100.0000	0.0114	63.7200	1.5141

- To restore all of the trials in the results table, close the **Experiment Result** pane and reopen the results from the **Experiment Browser**.

## View Source of Past Experiment Definitions

This example shows how to inspect the configuration of an experiment that produced a given result.

The **Experiment Source** pane contains a read-only copy of the experiment description and hyperparameter table, as well as links to the setup and metric functions called by the experiment. You can use the information in this pane to track the configuration of data, network, and training options that produce each of your results.

For instance, suppose that you run an experiment multiple times. Each time that you run the experiment, you change the contents of the setup function but always use the same name. The first time that you run the experiment, you use the default classification network provided by the setup function template. The second time that you run the experiment, you modify the setup function to load a pretrained GoogLeNet network, replacing the final layers with new layers for transfer learning. For an example that uses these two network architectures, see “Create a Deep Learning Experiment for Classification”.

On the first **Experiment Result** pane, click the **View Experiment Source** link. Experiment Manager opens an **Experiment Source** pane that contains the experiment definition that produced the first set of results. Click the link at the bottom of the pane to open the setup function that you used the first time you ran the experiment. You can copy this setup function to rerun the experiment using a simple classification network.

On the second **Experiment Result** pane, click the **View Experiment Source** link. Experiment Manager opens an **Experiment Source** pane that contains the experiment definition that produced the second set of results. Click the link at the bottom of the pane to open the setup function that you used the second time you ran the experiment. You can copy this setup function to rerun the experiment using transfer learning.

Experiment Manager stores a copy of the setup and custom metric functions that you use, so you do not have to manually rename these functions when you modify and rerun an experiment.

## Tips

To visualize, build, and train a network without sweeping hyperparameters, try the **Deep Network Designer** app.

## See Also

**Deep Network Designer** | `trainNetwork` | `trainingOptions`

## Topics

“Create a Deep Learning Experiment for Classification”

“Create a Deep Learning Experiment for Regression”  
“Evaluate Deep Learning Experiments by Using Metric Functions”  
“Try Multiple Pretrained Networks for Transfer Learning”  
“Experiment with Weight Initializers for Transfer Learning”

**Introduced in R2020a**

## adamupdate

Update parameters using adaptive moment estimation (Adam)

### Syntax

```
[dlnet, averageGrad, averageSqGrad] = adamupdate(dlnet, grad, averageGrad,
averageSqGrad, iteration)
[params, averageGrad, averageSqGrad] = adamupdate(params, grad, averageGrad,
averageSqGrad, iteration)
[ ___ ] = adamupdate( ___ learnRate, gradDecay, sqGradDecay, epsilon)
```

### Description

Update the network learnable parameters in a custom training loop using the adaptive moment estimation (Adam) algorithm.

---

**Note** This function applies the Adam optimization algorithm to update network parameters in custom training loops that use networks defined as `dlnetwork` objects or model functions. If you want to train a network defined as a `Layer` array or as a `LayerGraph`, use the following functions:

- Create a `TrainingOptionsADAM` object using the `trainingOptions` function.
  - Use the `TrainingOptionsADAM` object with the `trainNetwork` function.
- 

`[dlnet, averageGrad, averageSqGrad] = adamupdate(dlnet, grad, averageGrad, averageSqGrad, iteration)` updates the learnable parameters of the network `dlnet` using the Adam algorithm. Use this syntax in a training loop to iteratively update a network defined as a `dlnetwork` object.

`[params, averageGrad, averageSqGrad] = adamupdate(params, grad, averageGrad, averageSqGrad, iteration)` updates the learnable parameters in `params` using the Adam algorithm. Use this syntax in a training loop to iteratively update the learnable parameters of a network defined using functions.

`[ ___ ] = adamupdate( ___ learnRate, gradDecay, sqGradDecay, epsilon)` also specifies values to use for the global learning rate, gradient decay, square gradient decay, and small constant `epsilon`, in addition to the input arguments in previous syntaxes.

### Examples

#### Update Learnable Parameters Using adamupdate

Perform a single adaptive moment estimation update step with a global learning rate of `0.05`, gradient decay factor of `0.75`, and squared gradient decay factor of `0.95`.

Create the parameters and parameter gradients as numeric arrays.



```
params = rand(3,3,4);
grad = ones(3,3,4);
```

Initialize the iteration counter, average gradient, and average squared gradient for the first iteration.

```
iteration = 1;
averageGrad = [];
averageSqGrad = [];
```

Specify custom values for the global learning rate, gradient decay factor, and squared gradient decay factor.

```
learnRate = 0.05;
gradDecay = 0.75;
sqGradDecay = 0.95;
```

Update the learnable parameters using `adamupdate`.

```
[params,averageGrad,averageSqGrad] = adamupdate(params,grad,averageGrad,averageSqGrad,iteration,
```

Update the iteration counter.

```
iteration = iteration + 1;
```

## Train Network Using `adamupdate`

Use `adamupdate` to train a network using the Adam algorithm.

### Load Training Data

Load the digits training data.

```
[XTrain,YTrain] = digitTrain4DArrayData;
classes = categories(YTrain);
numClasses = numel(classes);
```

### Define Network

Define the network and specify the average image value using the 'Mean' option in the image input layer.

```
layers = [
    imageInputLayer([28 28 1], 'Name', 'input', 'Mean', mean(XTrain,4))
    convolution2dLayer(5,20, 'Name', 'conv1')
    reluLayer('Name', 'relu1')
    convolution2dLayer(3,20, 'Padding', 1, 'Name', 'conv2')
    reluLayer('Name', 'relu2')
    convolution2dLayer(3,20, 'Padding', 1, 'Name', 'conv3')
    reluLayer('Name', 'relu3')
    fullyConnectedLayer(numClasses, 'Name', 'fc')];
lgraph = layerGraph(layers);
```

Create a `dlnetwork` object from the layer graph.

```
dlnet = dlnetwork(lgraph);
```

### Define Model Gradients Function

Create the helper function `modelGradients`, listed at the end of the example. The function takes a `dlnetwork` object `dlnet` and a mini-batch of input data `dLX` with corresponding labels `Y`, and returns the loss and the gradients of the loss with respect to the learnable parameters in `dlnet`.

### Specify Training Options

Specify the options to use during training.

```
miniBatchSize = 128;  
numEpochs = 20;  
numObservations = numel(YTrain);  
numIterationsPerEpoch = floor(numObservations./miniBatchSize);
```

Train on a GPU, if one is available. Using a GPU requires Parallel Computing Toolbox™ and a CUDA® enabled NVIDIA® GPU with compute capability 3.0 or higher.

```
executionEnvironment = "auto";
```

Initialize the average gradients and squared average gradients.

```
averageGrad = [];  
averageSqGrad = [];
```

Initialize the iteration counter.

```
iteration = 1;
```

Initialize the training progress plot.

```
plots = "training-progress";  
if plots == "training-progress"  
    figure  
    lineLossTrain = animatedline;  
    xlabel("Total Iterations")  
    ylabel("Loss")  
end
```

### Train Network

Train the model using a custom training loop. For each epoch, shuffle the data and loop over mini-batches of data. Update the network parameters using the `adamupdate` function. At the end of each epoch, display the training progress.

```
for epoch = 1:numEpochs  
    % Shuffle data.  
    idx = randperm(numel(YTrain));  
    XTrain = XTrain(:,:, :, idx);  
    YTrain = YTrain(idx);  
  
    for i = 1:numIterationsPerEpoch  
  
        % Read mini-batch of data and convert the labels to dummy  
        % variables.  
        idx = (i-1)*miniBatchSize+1:i*miniBatchSize;  
        X = XTrain(:,:, :, idx);
```

```
Y = zeros(numClasses, miniBatchSize, 'single');
for c = 1:numClasses
    Y(c,YTrain(idx)==classes(c)) = 1;
end

% Convert mini-batch of data to a dlarray.
dlX = dlarray(single(X), 'SSCB');

% If training on a GPU, then convert data to a gpuArray.
if (executionEnvironment == "auto" && canUseGPU) || executionEnvironment == "gpu"
    dlX = gpuArray(dlX);
end

% Evaluate the model gradients and loss using dlfeval and the
% modelGradients helper function.
[grad,loss] = dlfeval(@modelGradients,dlnet,dlX,Y);

% Update the network parameters using the Adam optimizer.
[dlnet,averageGrad,averageSqGrad] = adamupdate(dlnet,grad,averageGrad,averageSqGrad,iteration);

% Display the training progress.
if plots == "training-progress"
    addpoints(lineLossTrain,iteration,double(gather(extractdata(loss))))
    title("Loss During Training: Epoch - " + epoch + "; Iteration - " + i)
    drawnow
end

% Increment the iteration counter.
iteration = iteration + 1;
end
end
```

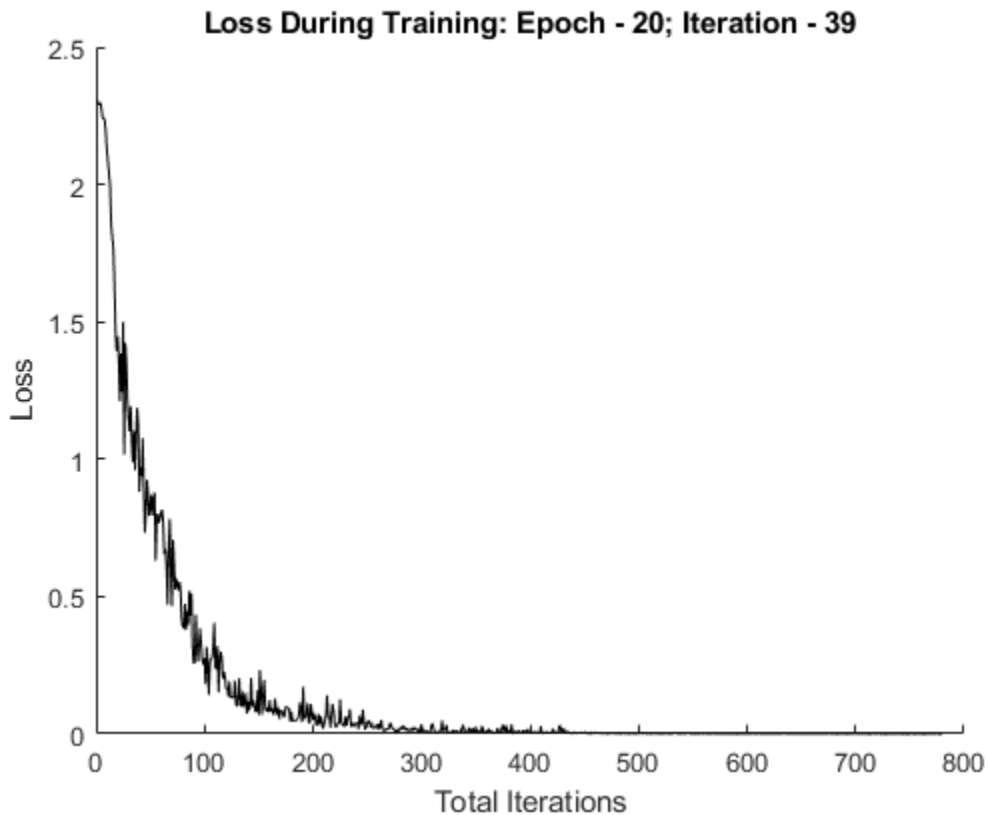

### Test Network

Test the classification accuracy of the model by comparing the predictions on a test set with the true labels.

```
[XTest, YTest] = digitTest4DArrayData;
```

Convert the data to a `dLarray` with the dimension format 'SSCB'. For GPU prediction, also convert the data to a `gpuArray`.

```
dLXTest = dLarray(XTest, 'SSCB');
if (executionEnvironment == "auto" && canUseGPU) || executionEnvironment == "gpu"
    dLXTest = gpuArray(dLXTest);
end
```

To classify images using a `dLnetwork` object, use the `predict` function and find the classes with the highest scores.

```
dLYPred = predict(dLnet, dLXTest);
[~, idx] = max(extractdata(dLYPred), [], 1);
YPred = classes(idx);
```

Evaluate the classification accuracy.

```
accuracy = mean(YPred == YTest)
```

```
accuracy = 0.9908
```

## Model Gradients Function

The `modelGradients` helper function takes a `dlnetwork` object `dlnet` and a mini-batch of input data `dlX` with corresponding labels `Y`, and returns the loss and the gradients of the loss with respect to the learnable parameters in `dlnet`. To compute the gradients automatically, use the `dlgradient` function.

```
function [gradients,loss] = modelGradients(dlnet,dlX,Y)

    dLYPred = forward(dlnet,dlX);
    dLYPred = softmax(dLYPred);

    loss = crossentropy(dLYPred,Y);
    gradients = dlgradient(loss,dlnet.Learnables);

end
```

## Input Arguments

### **dlnet** — Network

`dlnetwork` object

Network, specified as a `dlnetwork` object.

The function updates the `dlnet.Learnables` property of the `dlnetwork` object. `dlnet.Learnables` is a table with three variables:

- **Layer** — Layer name, specified as a string scalar.
- **Parameter** — Parameter name, specified as a string scalar.
- **Value** — Value of parameter, specified as a cell array containing a `dlarray`.

The input argument `grad` must be a table of the same form as `dlnet.Learnables`.

### **params** — Network learnable parameters

`dlarray` | numeric array | cell array | structure | table

Network learnable parameters, specified as a `dlarray`, a numeric array, a cell array, a structure, or a table.

If you specify `params` as a table, it must contain the following three variables:

- **Layer** — Layer name, specified as a string scalar.
- **Parameter** — Parameter name, specified as a string scalar.
- **Value** — Value of parameter, specified as a cell array containing a `dlarray`.

You can specify `params` as a container of learnable parameters for your network using a cell array, structure, or table, or nested cell arrays or structures. The learnable parameters inside the cell array, structure, or table must be `dlarray` or numeric values of data type `double` or `single`.

The input argument `grad` must be provided with exactly the same data type, ordering, and fields (for structures) or variables (for tables) as `params`.

Data Types: `single` | `double` | `struct` | `table` | `cell`

**grad — Gradients of the loss**

`dLarray` | numeric array | cell array | structure | table

Gradients of the loss, specified as a `dLarray`, a numeric array, a cell array, a structure, or a table.

The exact form of `grad` depends on the input network or learnable parameters. The following table shows the required format for `grad` for possible inputs to `adamupdate`.

Input	Learnable Parameters	Gradients
<code>dLnet</code>	Table <code>dLnet.Learnables</code> containing <code>Layer</code> , <code>Parameter</code> , and <code>Value</code> variables. The <code>Value</code> variable consists of cell arrays that contain each learnable parameter as a <code>dLarray</code> .	Table with the same data type, variables, and ordering as <code>dLnet.Learnables</code> . <code>grad</code> must have a <code>Value</code> variable consisting of cell arrays that contain the gradient of each learnable parameter.
<code>params</code>	<code>dLarray</code>	<code>dLarray</code> with the same data type and ordering as <code>params</code>
	Numeric array	Numeric array with the same data type and ordering as <code>params</code>
	Cell array	Cell array with the same data types, structure, and ordering as <code>params</code>
	Structure	Structure with the same data types, fields, and ordering as <code>params</code>
	Table with <code>Layer</code> , <code>Parameter</code> , and <code>Value</code> variables. The <code>Value</code> variable must consist of cell arrays that contain each learnable parameter as a <code>dLarray</code> .	Table with the same data types, variables, and ordering as <code>params</code> . <code>grad</code> must have a <code>Value</code> variable consisting of cell arrays that contain the gradient of each learnable parameter.

You can obtain `grad` from a call to `dLfeval` that evaluates a function that contains a call to `dLgradient`. For more information, see “Use Automatic Differentiation In Deep Learning Toolbox”.

**averageGrad — Moving average of parameter gradients**

`[]` | `dLarray` | numeric array | cell array | structure | table

Moving average of parameter gradients, specified as an empty array, a `dLarray`, a numeric array, a cell array, a structure, or a table.

The exact form of `averageGrad` depends on the input network or learnable parameters. The following table shows the required format for `averageGrad` for possible inputs to `adamupdate`.

Input	Learnable Parameters	Average Gradients
<code>dlnet</code>	Table <code>dlnet.Learnables</code> containing <code>Layer</code> , <code>Parameter</code> , and <code>Value</code> variables. The <code>Value</code> variable consists of cell arrays that contain each learnable parameter as a <code>dlarray</code> .	Table with the same data type, variables, and ordering as <code>dlnet.Learnables</code> . <code>averageGrad</code> must have a <code>Value</code> variable consisting of cell arrays that contain the average gradient of each learnable parameter.
<code>params</code>	<code>dlarray</code>	<code>dlarray</code> with the same data type and ordering as <code>params</code>
	Numeric array	Numeric array with the same data type and ordering as <code>params</code>
	Cell array	Cell array with the same data types, structure, and ordering as <code>params</code>
	Structure	Structure with the same data types, fields, and ordering as <code>params</code>
	Table with <code>Layer</code> , <code>Parameter</code> , and <code>Value</code> variables. The <code>Value</code> variable must consist of cell arrays that contain each learnable parameter as a <code>dlarray</code> .	Table with the same data types, variables, and ordering as <code>params</code> . <code>averageGrad</code> must have a <code>Value</code> variable consisting of cell arrays that contain the average gradient of each learnable parameter.

If you specify `averageGrad` and `averageSqGrad` as empty arrays, the function assumes no previous gradients and runs in the same way as for the first update in a series of iterations. To update the learnable parameters iteratively, use the `averageGrad` output of a previous call to `adamupdate` as the `averageGrad` input.

### **averageSqGrad — Moving average of squared parameter gradients**

[ ] | `dlarray` | numeric array | cell array | structure | table

Moving average of squared parameter gradients, specified as an empty array, a `dlarray`, a numeric array, a cell array, a structure, or a table.

The exact form of `averageSqGrad` depends on the input network or learnable parameters. The following table shows the required format for `averageSqGrad` for possible inputs to `adamupdate`.

Input	Learnable parameters	Average Squared Gradients
<code>dlnet</code>	Table <code>dlnet.Learnables</code> containing <code>Layer</code> , <code>Parameter</code> , and <code>Value</code> variables. The <code>Value</code> variable consists of cell arrays that contain each learnable parameter as a <code>dlnet</code> .	Table with the same data type, variables, and ordering as <code>dlnet.Learnables</code> . <code>averageSqGrad</code> must have a <code>Value</code> variable consisting of cell arrays that contain the average squared gradient of each learnable parameter.
<code>params</code>	<code>dlnet</code>	<code>dlnet</code> with the same data type and ordering as <code>params</code>
	Numeric array	Numeric array with the same data type and ordering as <code>params</code>
	Cell array	Cell array with the same data types, structure, and ordering as <code>params</code>
	Structure	Structure with the same data types, fields, and ordering as <code>params</code>
	Table with <code>Layer</code> , <code>Parameter</code> , and <code>Value</code> variables. The <code>Value</code> variable must consist of cell arrays that contain each learnable parameter as a <code>dlnet</code> .	Table with the same data types, variables and ordering as <code>params</code> . <code>averageSqGrad</code> must have a <code>Value</code> variable consisting of cell arrays that contain the average squared gradient of each learnable parameter.

If you specify `averageGrad` and `averageSqGrad` as empty arrays, the function assumes no previous gradients and runs in the same way as for the first update in a series of iterations. To update the learnable parameters iteratively, use the `averageSqGrad` output of a previous call to `adamupdate` as the `averageSqGrad` input.

**iteration — Iteration number**

positive integer

Iteration number, specified as a positive integer. For the first call to `adamupdate`, use a value of 1. You must increment `iteration` by 1 for each subsequent call in a series of calls to `adamupdate`. The Adam algorithm uses this value to correct for bias in the moving averages at the beginning of a set of iterations.

**LearnRate — Global learning rate**

0.001 (default) | positive scalar

Global learning rate, specified as a positive scalar. The default value of `LearnRate` is 0.001.

If you specify the network parameters as a `dlnetwork`, the learning rate for each parameter is the global learning rate multiplied by the corresponding learning rate factor property defined in the network layers.



**gradDecay — Gradient decay factor**

0.9 (default) | positive scalar between 0 and 1

Gradient decay factor, specified as a positive scalar between 0 and 1. The default value of `gradDecay` is 0.9.

**sqGradDecay — Squared gradient decay factor**

0.999 (default) | positive scalar between 0 and 1

Squared gradient decay factor, specified as a positive scalar between 0 and 1. The default value of `sqGradDecay` is 0.999.

**epsilon — Small constant**

1e-8 (default) | positive scalar

Small constant for preventing divide-by-zero errors, specified as a positive scalar. The default value of `epsilon` is 1e-8.

## Output Arguments

**dlnet — Updated network**

`dlnetwork` object

Network, returned as a `dlnetwork` object.

The function updates the `dlnet.Learnables` property of the `dlnetwork` object.

**params — Updated network learnable parameters**

`dlarray` | numeric array | cell array | structure | table

Updated network learnable parameters, returned as a `dlarray`, a numeric array, a cell array, a structure, or a table with a `Value` variable containing the updated learnable parameters of the network.

**averageGrad — Updated moving average of parameter gradients**

`dlarray` | numeric array | cell array | structure | table

Updated moving average of parameter gradients, returned as a `dlarray`, a numeric array, a cell array, a structure, or a table.

**averageSqGrad — Updated moving average of squared parameter gradients**

`dlarray` | numeric array | cell array | structure | table

Updated moving average of squared parameter gradients, returned as a `dlarray`, a numeric array, a cell array, a structure, or a table.

## More About

**Adam**

The function uses the adaptive moment estimation (Adam) algorithm to update the learnable parameters. For more information, see the definition of the Adam algorithm under “Stochastic Gradient Descent” on page 1-800 on the `trainingOptions` reference page.

## Extended Capabilities

### GPU Arrays

Accelerate code by running on a graphics processing unit (GPU) using Parallel Computing Toolbox™.

Usage notes and limitations:

- When at least one of the following input arguments is a `gpuArray` or a `dlarray` with underlying data of type `gpuArray`, this function runs on the GPU.
  - `grad`
  - `averageGrad`
  - `averageSqGrad`
  - `params`

For more information, see “Run MATLAB Functions on a GPU” (Parallel Computing Toolbox).

### See Also

`dlarray` | `dlfeval` | `dlgradient` | `dlnetwork` | `dlupdate` | `forward` | `rmspropupdate` | `sgdmupdate`

### Topics

“Define Custom Training Loops, Loss Functions, and Networks”

“Specify Training Options in Custom Training Loop”

“Train Network Using Custom Training Loop”

### Introduced in R2019b

# activations

Compute deep learning network layer activations

## Syntax

```
features = activations(net,imds,layer)
features = activations(net,ds,layer)

features = activations(net,X,layer)
features = activations(net,sequences,layer)

features = activations(net,tbl,layer)

features = activations( ___,Name,Value)
```

## Description

You can extract features using a trained deep learning network on either a CPU or GPU. Using a GPU requires Parallel Computing Toolbox™ and a CUDA® enabled NVIDIA® GPU with compute capability 3.0 or higher. Specify the hardware requirements using the `ExecutionEnvironment` name-value pair argument.

`features = activations(net,imds,layer)` returns network activations for a specific layer using the trained network `net` and the image data in the image datastore `imds`.

`features = activations(net,ds,layer)` returns network activations using the data in the datastore `ds`. For networks with multiple inputs, use this syntax with a combined or transformed datastore object.

`features = activations(net,X,layer)` returns network activations using the image data in the numeric array `X`.

`features = activations(net,sequences,layer)` returns network activations for an LSTM or BiLSTM network, where `sequences` contains sequence or time series predictors.

`features = activations(net,tbl,layer)` returns network activations using the data in the table of images `tbl`.

`features = activations( ___,Name,Value)` returns network activations with additional options specified by one or more name-value pair arguments. For example, `'OutputAs','rows'` specifies the activation output format as `'rows'`. Specify name-value pair arguments after all other input arguments.

## Examples

### Feature Extraction Using AlexNet

This example shows how to extract learned image features from a pretrained convolutional neural network, and use those features to train an image classifier. Feature extraction is the easiest and

fastest way to use the representational power of pretrained deep networks. For example, you can train a support vector machine (SVM) using `fitcecoc` (Statistics and Machine Learning Toolbox™) on the extracted features. Because feature extraction only requires a single pass through the data, it is a good starting point if you do not have a GPU to accelerate network training with.

### Load Data

Unzip and load the sample images as an image datastore. `imageDatastore` automatically labels the images based on folder names and stores the data as an `ImageDatastore` object. An image datastore lets you store large image data, including data that does not fit in memory. Split the data into 70% training and 30% test data.

```
unzip('MerchData.zip');

imds = imageDatastore('MerchData', ...
    'IncludeSubfolders',true, ...
    'LabelSource','foldernames');

[imdsTrain,imdsTest] = splitEachLabel(imds,0.7,'randomized');
```

There are now 55 training images and 20 validation images in this very small data set. Display some sample images.

```
numImagesTrain = numel(imdsTrain.Labels);
idx = randperm(numImagesTrain,16);

for i = 1:16
    I{i} = readimage(imdsTrain,idx(i));
end

figure
imshow(imtile(I))
```



### Load Pretrained Network

Load a pretrained AlexNet network. If the Deep Learning Toolbox Model *for AlexNet Network* support package is not installed, then the software provides a download link. AlexNet is trained on more than a million images and can classify images into 1000 object categories. For example, keyboard, mouse, pencil, and many animals. As a result, the model has learned rich feature representations for a wide range of images.

```
net = alexnet;
```

Display the network architecture. The network has five convolutional layers and three fully connected layers.

```
net.Layers
```

```
ans =
```

```
25x1 Layer array with layers:
```

1	'data'	Image Input	227x227x3 images with 'zerocenter' normalization
2	'conv1'	Convolution	96 11x11x3 convolutions with stride [4 4] and padding
3	'relu1'	ReLU	ReLU
4	'norm1'	Cross Channel Normalization	cross channel normalization with 5 channels per group
5	'pool1'	Max Pooling	3x3 max pooling with stride [2 2] and padding
6	'conv2'	Grouped Convolution	2 groups of 128 5x5x48 convolutions with stride [2 2] and padding
7	'relu2'	ReLU	ReLU
8	'norm2'	Cross Channel Normalization	cross channel normalization with 5 channels per group
9	'pool2'	Max Pooling	3x3 max pooling with stride [2 2] and padding
10	'conv3'	Convolution	384 3x3x256 convolutions with stride [1 1] and padding
11	'relu3'	ReLU	ReLU
12	'conv4'	Grouped Convolution	2 groups of 192 3x3x192 convolutions with stride [1 1] and padding
13	'relu4'	ReLU	ReLU
14	'conv5'	Grouped Convolution	2 groups of 128 3x3x192 convolutions with stride [1 1] and padding
15	'relu5'	ReLU	ReLU
16	'pool5'	Max Pooling	3x3 max pooling with stride [2 2] and padding
17	'fc6'	Fully Connected	4096 fully connected layer
18	'relu6'	ReLU	ReLU
19	'drop6'	Dropout	50% dropout
20	'fc7'	Fully Connected	4096 fully connected layer
21	'relu7'	ReLU	ReLU
22	'drop7'	Dropout	50% dropout
23	'fc8'	Fully Connected	1000 fully connected layer
24	'prob'	Softmax	softmax
25	'output'	Classification Output	crossentropyex with 'tench' and 999 other classes

The first layer, the image input layer, requires input images of size 227-by-227-by-3, where 3 is the number of color channels.

```
inputSize = net.Layers(1).InputSize
```

```
inputSize = 1x3
```

```
227 227 3
```

### Extract Image Features

The network constructs a hierarchical representation of input images. Deeper layers contain higher-level features, constructed using the lower-level features of earlier layers. To get the feature representations of the training and test images, use `activations` on the fully connected layer 'fc7'. To get a lower-level representation of the images, use an earlier layer in the network.

The network requires input images of size 227-by-227-by-3, but the images in the image datastores have different sizes. To automatically resize the training and test images before they are input to the network, create augmented image datastores, specify the desired image size, and use these datastores as input arguments to `activations`.

```
augImdsTrain = augmentedImageDatastore(inputSize(1:2), imdsTrain);
```

```
augImdsTest = augmentedImageDatastore(inputSize(1:2), imdsTest);
```

```
layer = 'fc7';
```

```
featuresTrain = activations(net, augimdsTrain, layer, 'OutputAs', 'rows');  
featuresTest = activations(net, augimdsTest, layer, 'OutputAs', 'rows');
```

Extract the class labels from the training and test data.

```
YTrain = imdsTrain.Labels;  
YTest = imdsTest.Labels;
```

### Fit Image Classifier

Use the features extracted from the training images as predictor variables and fit a multiclass support vector machine (SVM) using `fitcecoc` (Statistics and Machine Learning Toolbox).

```
mdl = fitcecoc(featuresTrain, YTrain);
```

### Classify Test Images

Classify the test images using the trained SVM model and the features extracted from the test images.

```
YPred = predict(mdl, featuresTest);
```

Display four sample test images with their predicted labels.

```
idx = [1 5 10 15];  
figure  
for i = 1:numel(idx)  
    subplot(2,2,i)  
    I = readimage(imdsTest, idx(i));  
    label = YPred(idx(i));  
  
    imshow(I)  
    title(label)  
end
```

**MathWorks Cap**



**MathWorks Cube**



**MathWorks Playing Cards**

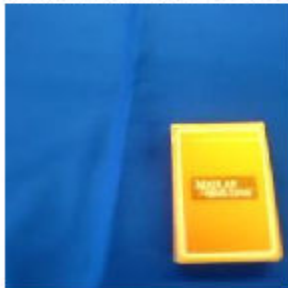

**MathWorks Screwdriver**



Calculate the classification accuracy on the test set. Accuracy is the fraction of labels that the network predicts correctly.

```
accuracy = mean(YPred == YTest)
```

```
accuracy = 1
```

This SVM has high accuracy. If the accuracy is not high enough using feature extraction, then try transfer learning instead.

## Input Arguments

### **net** — Trained network

SeriesNetwork object | DAGNetwork object

Trained network, specified as a SeriesNetwork or a DAGNetwork object. You can get a trained network by importing a pretrained network (for example, by using the `googlenet` function) or by training your own network using `trainNetwork`.

### **imds** — Image datastore

ImageDatastore object

Image datastore, specified as an ImageDatastore object.

ImageDatastore allows batch reading of JPG or PNG image files using prefetching. If you use a custom function for reading the images, then ImageDatastore does not prefetch.



**Tip** Use `augmentedImageDatastore` for efficient preprocessing of images for deep learning including image resizing.

Do not use the `readFcn` option of `imageDatastore` as this option is usually significantly slower.

**ds — Datastore**

`datastore`

Datastore of input data.

For networks with a single input, `ds` can return either:

- a single image or sequence
- a cell array of images or sequences
- a table, where the first column contains images or sequences

For networks with multiple image inputs layers, `ds` must be a combined or transformed datastore that returns a cell array with `numInputs` columns containing the input data, where `numInputs` is the number of network inputs. The `i`th element of the cell array corresponds to the input `net.InputNames(i)`.

For more information, see “Datastores for Deep Learning”.

**X — Image data**

`numeric array`

Image data, specified as a numeric array. The size of the array depends on the type of image input:

Input	Description
2-D images	A $h$ -by- $w$ -by- $c$ -by- $N$ numeric array, where $h$ , $w$ , and $c$ are the height, width, and number of channels of the images, respectively, and $N$ is the number of images.
3-D images	A $h$ -by- $w$ -by- $d$ -by- $c$ -by- $N$ numeric array, where $h$ , $w$ , $d$ , and $c$ are the height, width, depth, and number of channels of the images, respectively, and $N$ is the number of images.

If the array contains NaNs, then they are propagated through the network.

For image input, if the 'OutputAs' option is 'channels', then the images in the input data `X` can be larger than the input size of the image input layer of the network. For other output formats, the images in `X` must have the same size as the input size of the image input layer of the network.

**sequences — Sequence or time series data**

`cell array of numeric arrays` | `numeric array` | `datastore`

Sequence or time series data, specified as an  $N$ -by-1 cell array of numeric arrays, where  $N$  is the number of observations, a numeric array representing a single sequence, or a datastore.

For cell array or numeric array input, the dimensions of the numeric arrays containing the sequences depend on the type of data.

Input	Description
Vector sequences	$c$ -by- $s$ matrices, where $c$ is the number of features of the sequences and $s$ is the sequence length.
2-D image sequences	$h$ -by- $w$ -by- $c$ -by- $s$ arrays, where $h$ , $w$ , and $c$ correspond to the height, width, and number of channels of the images, respectively, and $s$ is the sequence length.
3-D image sequences	$h$ -by- $w$ -by- $d$ -by- $c$ -by- $s$ , where $h$ , $w$ , $d$ , and $c$ correspond to the height, width, depth, and number of channels of the 3-D images, respectively, and $s$ is the sequence length.

For datastore input, the datastore must return data as a cell array of sequences or a table whose first column contains sequences. The dimensions of the sequence data must correspond to the table above.

**tbl — Table of images**

table

Table of images containing the input data in the first column. Each row in the table corresponds to an observation. The table contains absolute or relative file paths to an image, specified as a character vector or images specified as a numeric array.

Data Types: table

**layer — Layer to extract features from**

numeric index | character vector

Layer to extract features from, specified as a numeric index or a character vector.

To compute the activations of a `SeriesNetwork` object, specify the layer using its numeric index, or as a character vector corresponding to the layer name.

To compute the activations of a `DAGNetwork` object, specify the layer as the character vector corresponding to the layer name. If the layer has multiple outputs, specify the layer and output as the layer name, followed by the character `"/"`, followed by the name of the layer output. That is, `layer` is of the form `'layerName/outputName'`.

Example: 3

Example: 'conv1'

Example: 'mpool/out'

**Name-Value Pair Arguments**

Specify optional comma-separated pairs of `Name`, `Value` arguments. `Name` is the argument name and `Value` is the corresponding value. `Name` must appear inside quotes. You can specify several name and value pair arguments in any order as `Name1, Value1, ..., NameN, ValueN`.

Example: `activations(net,X,layer,'OutputAs','rows')`

**OutputAs — Format of output activations**

'channels' (default) | 'rows' | 'columns'

Format of output activations, specified as the comma-separated pair consisting of `'OutputAs'` and either `'channels'`, `'rows'`, or `'columns'`. For descriptions of the different output formats, see [features](#).

For image input, if the `'OutputAs'` option is `'channels'`, then the images in the input data  $X$  can be larger than the input size of the image input layer of the network. For other output formats, the images in  $X$  must have the same size as the input size of the image input layer of the network.

Example: `'OutputAs', 'rows'`

### **MiniBatchSize — Size of mini-batches**

128 (default) | positive integer

Size of mini-batches to use for prediction, specified as a positive integer. Larger mini-batch sizes require more memory, but can lead to faster predictions.

Example: `'MiniBatchSize', 256`

### **SequenceLength — Option to pad, truncate, or split input sequences**

`'longest'` (default) | `'shortest'` | positive integer

Option to pad, truncate, or split input sequences, specified as one of the following:

- `'longest'` — Pad sequences in each mini-batch to have the same length as the longest sequence. This option does not discard any data, though padding can introduce noise to the network.
- `'shortest'` — Truncate sequences in each mini-batch to have the same length as the shortest sequence. This option ensures that no padding is added, at the cost of discarding data.
- Positive integer — For each mini-batch, pad the sequences to the nearest multiple of the specified length that is greater than the longest sequence length in the mini-batch, and then split the sequences into smaller sequences of the specified length. If splitting occurs, then the software creates extra mini-batches. Use this option if the full sequences do not fit in memory. Alternatively, try reducing the number of sequences per mini-batch by setting the `'MiniBatchSize'` option to a lower value.

To learn more about the effect of padding, truncating, and splitting the input sequences, see [“Sequence Padding, Truncation, and Splitting”](#).

Example: `'SequenceLength', 'shortest'`

### **SequencePaddingValue — Value to pad input sequences**

0 (default) | scalar

Value by which to pad input sequences, specified as a scalar. The option is valid only when `SequenceLength` is `'longest'` or a positive integer. Do not pad sequences with NaN, because doing so can propagate errors throughout the network.

Example: `'SequencePaddingValue', -1`

### **SequencePaddingDirection — Direction of padding or truncation**

`'right'` (default) | `'left'`

Direction of padding or truncation, specified as one of the following:

- `'right'` — Pad or truncate sequences on the right. The sequences start at the same time step and the software truncates or adds padding to the end of the sequences.

- `'left'` — Pad or truncate sequences on the left. The software truncates or adds padding to the start of the sequences so that the sequences end at the same time step.

Because LSTM layers process sequence data one time step at a time, when the layer `OutputMode` property is `'last'`, any padding in the final time steps can negatively influence the layer output. To pad or truncate sequence data on the left, set the `'SequencePaddingDirection'` option to `'left'`.

For sequence-to-sequence networks (when the `OutputMode` property is `'sequence'` for each LSTM layer), any padding in the first time steps can negatively influence the predictions for the earlier time steps. To pad or truncate sequence data on the right, set the `'SequencePaddingDirection'` option to `'right'`.

To learn more about the effect of padding, truncating, and splitting the input sequences, see “Sequence Padding, Truncation, and Splitting”.

### Acceleration — Performance optimization

`'auto'` (default) | `'mex'` | `'none'`

Performance optimization, specified as the comma-separated pair consisting of `'Acceleration'` and one of the following:

- `'auto'` — Automatically apply a number of optimizations suitable for the input network and hardware resource.
- `'mex'` — Compile and execute a MEX function. This option is available when using a GPU only. Using a GPU requires Parallel Computing Toolbox and a CUDA enabled NVIDIA GPU with compute capability 3.0 or higher. If Parallel Computing Toolbox or a suitable GPU is not available, then the software returns an error.
- `'none'` — Disable all acceleration.

The default option is `'auto'`. If `'auto'` is specified, MATLAB will apply a number of compatible optimizations. If you use the `'auto'` option, MATLAB does not ever generate a MEX function.

Using the `'Acceleration'` options `'auto'` and `'mex'` can offer performance benefits, but at the expense of an increased initial run time. Subsequent calls with compatible parameters are faster. Use performance optimization when you plan to call the function multiple times using new input data.

The `'mex'` option generates and executes a MEX function based on the network and parameters used in the function call. You can have several MEX functions associated with a single network at one time. Clearing the network variable also clears any MEX functions associated with that network.

The `'mex'` option is only available when you are using a GPU. You must have a C/C++ compiler installed and the GPU Coder™ Interface for Deep Learning Libraries support package. Install the support package using the Add-On Explorer in MATLAB. For setup instructions, see “MEX Setup” (GPU Coder). GPU Coder is not required.

The `'mex'` option does not support all layers. For a list of supported layers, see “Supported Layers” (GPU Coder). Recurrent neural networks (RNNs) containing a `sequenceInputLayer` are not supported.

You cannot use MATLAB Compiler™ to deploy your network when using the `'mex'` option.

Example: `'Acceleration','mex'`

### ExecutionEnvironment — Hardware resource

'auto' (default) | 'gpu' | 'cpu'

Hardware resource, specified as the comma-separated pair consisting of 'ExecutionEnvironment' and one of the following:

- 'auto' — Use a GPU if one is available; otherwise, use the CPU.
- 'gpu' — Use the GPU. Using a GPU requires Parallel Computing Toolbox and a CUDA enabled NVIDIA GPU with compute capability 3.0 or higher. If Parallel Computing Toolbox or a suitable GPU is not available, then the software returns an error.
- 'cpu' — Use the CPU.

Example: 'ExecutionEnvironment','cpu'

## Output Arguments

### features — Activations from the network layer

numeric array | cell array

Activations from the network layer, returned as a numeric array or a cell array of numeric arrays. The format of `features` depends on the type of input data, the type of layer output, and the 'OutputAs' option.

#### Image Input

If `net` has an image input layer, then `features` is a numeric array.

'OutputAs'	features
'channels'	For 2-D image data, <code>features</code> is an $h$ -by- $w$ -by- $c$ -by- $n$ array, where $h$ , $w$ , and $c$ are the height, width, and number of channels for the output of the chosen layer, respectively, and $n$ is the number of images. In this case, <code>features(:, :, :, i)</code> contains the activations for the $i$ th image.  For 3-D image data, <code>features</code> is an $h$ -by- $w$ -by- $d$ -by- $c$ -by- $n$ array, where $h$ , $w$ , $d$ , and $c$ are the height, width, depth, and number of channels for the output of the chosen layer, respectively, and $n$ is the number of images. In this case, <code>features(:, :, :, :, i)</code> contains the activations for the $i$ th image.
'rows'	$n$ -by- $m$ matrix, where $n$ is the number of observations, and $m$ is the number of output elements from the chosen layer. In this case, <code>features(i, :)</code> contains the activations for the $i$ th image.
'columns'	$m$ -by- $n$ matrix, where $m$ is the number of output elements from the chosen layer, and $n$ is the number of observations. In this case, <code>features(:, i)</code> contains the activations for the $i$ th image.

#### Sequence Input

If `net` has a sequence input layer, and `layer` has sequence output (for example, LSTM layers with output mode 'sequence'), then `features` is a cell array. In this case, the 'OutputAs' option must be 'channels'.

'OutputAs'	features
'channels'	<p>For vector sequence input, <b>features</b> is a <math>n</math>-by-1 cell array, of <math>c</math>-by-<math>s</math> matrices, where <math>n</math> is the number of sequences, <math>c</math> is the number of features in the sequence, and <math>s</math> is the sequence length.</p> <p>For 2-D image sequence input, <b>features</b> is a <math>n</math>-by-1 cell array, of <math>h</math>-by-<math>w</math>-by-<math>c</math>-by-<math>s</math> matrices, where <math>n</math> is the number of sequences, <math>h</math>, <math>w</math>, and <math>c</math> are the height, width, and the number of channels of the images, respectively, and <math>s</math> is the sequence length.</p> <p>For 3-D image sequence input, <b>features</b> is a <math>n</math>-by-1 cell array, of <math>h</math>-by-<math>w</math>-by-<math>c</math>-by-<math>d</math>-by-<math>s</math> matrices, where <math>n</math> is the number of sequences, <math>h</math>, <math>w</math>, <math>d</math>, and <math>c</math> are the height, width, depth, and the number of channels of the images, respectively, and <math>s</math> is the sequence length.</p> <p>In these cases, <b>features</b>{<math>i</math>} contains the activations of the <math>i</math>th sequence.</p>

If **net** has a sequence input layer and **layer** outputs non-sequence data (for example, an LSTM layer with output mode 'last'), then **features** is a numeric array.

'OutputAs'	features
'channels'	<p>For vector sequence input, <b>features</b> is a <math>c</math>-by-<math>n</math> matrix, where <math>n</math> is the number of sequences and <math>c</math> is the number of features in the sequence.</p> <p>For 2-D image sequence input, <b>features</b> is a <math>h</math>-by-<math>w</math>-by-<math>c</math>-by-<math>n</math> array, where <math>n</math> is the number of sequences, <math>h</math>, <math>w</math>, and <math>c</math> are the height, width, and the number of channels of the images, respectively.</p> <p>For 3-D image sequence input, <b>features</b> is a <math>h</math>-by-<math>w</math>-by-<math>c</math>-by-<math>d</math>-by-<math>n</math> array, where <math>n</math> is the number of sequences, <math>h</math>, <math>w</math>, <math>d</math>, and <math>c</math> are the height, width, depth, and the number of channels of the images, respectively.</p> <p>In these cases, <b>features</b>{<math>i</math>} contains the activations of the <math>i</math>th sequence.</p>
'rows'	<p><math>n</math>-by-<math>m</math> matrix, where <math>n</math> is the number of observations, and <math>m</math> is the number of output elements from the chosen layer. In this case, <b>features</b>(<math>i</math>, :) contains the activations for the <math>i</math>th sequence.</p>
'columns'	<p><math>m</math>-by-<math>n</math> matrix, where <math>m</math> is the number of output elements from the chosen layer, and <math>n</math> is the number of observations. In this case, <b>features</b>(:, <math>i</math>) contains the activations for the <math>i</math>th image.</p>

## Algorithms

All functions for deep learning training, prediction, and validation in Deep Learning Toolbox perform computations using single-precision, floating-point arithmetic. Functions for deep learning include **trainNetwork**, **predict**, **classify**, and **activations**. The software uses single-precision arithmetic when you train networks using both CPUs and GPUs.

## References

- [1] M. Kudo, J. Toyama, and M. Shimbo. "Multidimensional Curve Classification Using Passing-Through Regions." *Pattern Recognition Letters*. Vol. 20, No. 11-13, pages 1103-1111.

[2] *UCI Machine Learning Repository: Japanese Vowels Dataset*. <https://archive.ics.uci.edu/ml/datasets/Japanese+Vowels>

## Extended Capabilities

### C/C++ Code Generation

Generate C and C++ code using MATLAB® Coder™.

Usage notes and limitations:

- The input X must not have a variable size. The size must be fixed at code generation time.
- The layer argument must be constant.
- Only the 'OutputAs' name-value pair argument is supported. The value must be 'channels'.

For more information about generating code for deep learning neural networks, see “Workflow for Deep Learning Code Generation with MATLAB Coder” (MATLAB Coder).

### GPU Code Generation

Generate CUDA® code for NVIDIA® GPUs using GPU Coder™.

Usage notes and limitations:

- GPU code generation supports the following syntaxes:
  - `features = activations(net,X,layer)`
  - `features = activations(__,Name,Value)`
- The input X must not have variable size. The size must be fixed at code generation time.
- GPU code generation for the `activations` function supports inputs that are defined as half-precision floating point data types. For more information, see `half`.
- The layer argument must be a compile-time constant.
- Only the 'OutputAs' and 'MiniBatchSize' name-value pair arguments are supported for code generation. The value of the 'OutputAs' name-value pair must be 'channels'.
- All name-value pairs must be compile-time constants.

## See Also

`classify` | `deepDreamImage` | `predict` | `trainNetwork`

### Topics

“Transfer Learning Using AlexNet”

“Visualize Activations of a Convolutional Neural Network”

“Visualize Activations of LSTM Network”

“Deep Learning in MATLAB”

**Introduced in R2016a**

# additionLayer

Addition layer

## Description

An addition layer adds inputs from multiple neural network layers element-wise.

Specify the number of inputs to the layer when you create it. The inputs to the layer have the names 'in1', 'in2', ..., 'inN', where N is the number of inputs. Use the input names when connecting or disconnecting the layer by using `connectLayers` or `disconnectLayers`. All inputs to an addition layer must have the same dimension.

## Creation

### Syntax

```
layer = additionLayer(numInputs)
layer = additionLayer(numInputs, 'Name', Name)
```

### Description

`layer = additionLayer(numInputs)` creates an addition layer that adds `numInputs` inputs element-wise. This function also sets the `NumInputs` property.

`layer = additionLayer(numInputs, 'Name', Name)` also sets the `Name` property. To create a network containing an addition layer, you must specify a layer name.

## Properties

### NumInputs — Number of inputs

positive integer

Number of inputs to the layer, specified as a positive integer.

The inputs have the names 'in1', 'in2', ..., 'inN', where N equals `NumInputs`. For example, if `NumInputs` equals 3, then the inputs have the names 'in1', 'in2', and 'in3'. Use the input names when connecting or disconnecting the layer by using `connectLayers` or `disconnectLayers`.

### Name — Layer name

' ' (default) | character vector | string scalar

Layer name, specified as a character vector or a string scalar. To include this layer in a layer graph, you must specify a layer name.

Data Types: char | string



**InputNames — Input Names**

```
{'in1','in2',..., 'inN'} (default)
```

Input names, specified as {'in1','in2',..., 'inN'}, where N is the number of inputs of the layer.

Data Types: cell

**NumOutputs — Number of outputs**

```
1 (default)
```

Number of outputs of the layer. This layer has a single output only.

Data Types: double

**OutputNames — Output names**

```
{'out'} (default)
```

Output names of the layer. This layer has a single output only.

Data Types: cell

**Examples****Create and Connect Addition Layer**

Create an addition layer with two inputs and the name 'add\_1'.

```
add = additionLayer(2,'Name','add_1')
```

```
add =
    AdditionLayer with properties:
```

```
        Name: 'add_1'
    NumInputs: 2
    InputNames: {'in1' 'in2'}
```

Create two ReLU layers and connect them to the addition layer. The addition layer sums the outputs from the ReLU layers.

```
relu_1 = reluLayer('Name','relu_1');
relu_2 = reluLayer('Name','relu_2');
```

```
lgraph = layerGraph;
lgraph = addLayers(lgraph,relu_1);
lgraph = addLayers(lgraph,relu_2);
lgraph = addLayers(lgraph,add);
```

```
lgraph = connectLayers(lgraph,'relu_1','add_1/in1');
lgraph = connectLayers(lgraph,'relu_2','add_1/in2');
```

```
plot(lgraph)
```

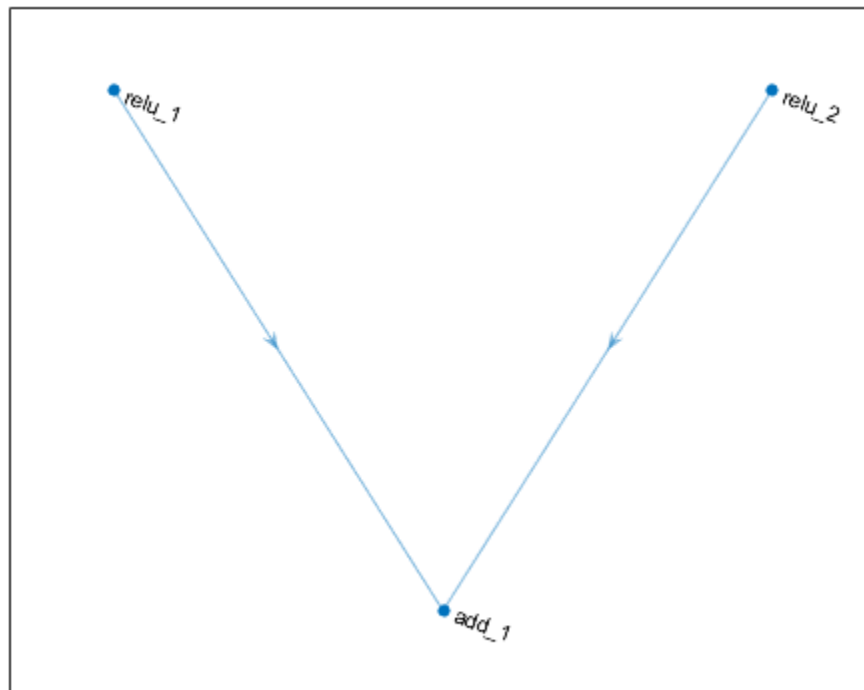

### Create Simple DAG Network

Create a simple directed acyclic graph (DAG) network for deep learning. Train the network to classify images of digits. The simple network in this example consists of:

- A main branch with layers connected sequentially.
- A *shortcut connection* containing a single 1-by-1 convolutional layer. Shortcut connections enable the parameter gradients to flow more easily from the output layer to the earlier layers of the network.

Create the main branch of the network as a layer array. The addition layer sums multiple inputs element-wise. Specify the number of inputs for the addition layer to sum. All layers must have names and all names must be unique.

```
layers = [  
    imageInputLayer([28 28 1], 'Name', 'input')  
  
    convolution2dLayer(5,16, 'Padding', 'same', 'Name', 'conv_1')  
    batchNormalizationLayer('Name', 'BN_1')  
    reluLayer('Name', 'relu_1')  
  
    convolution2dLayer(3,32, 'Padding', 'same', 'Stride', 2, 'Name', 'conv_2')  
    batchNormalizationLayer('Name', 'BN_2')  
    reluLayer('Name', 'relu_2')  
    convolution2dLayer(3,32, 'Padding', 'same', 'Name', 'conv_3')  
    batchNormalizationLayer('Name', 'BN_3')
```

```

reluLayer('Name','relu_3')
additionLayer(2,'Name','add')
averagePooling2dLayer(2,'Stride',2,'Name','avpool')
fullyConnectedLayer(10,'Name','fc')
softmaxLayer('Name','softmax')
classificationLayer('Name','classOutput')];

```

Create a layer graph from the layer array. `layerGraph` connects all the layers in `layers` sequentially. Plot the layer graph.

```

lgraph = layerGraph(layers);
figure
plot(lgraph)

```

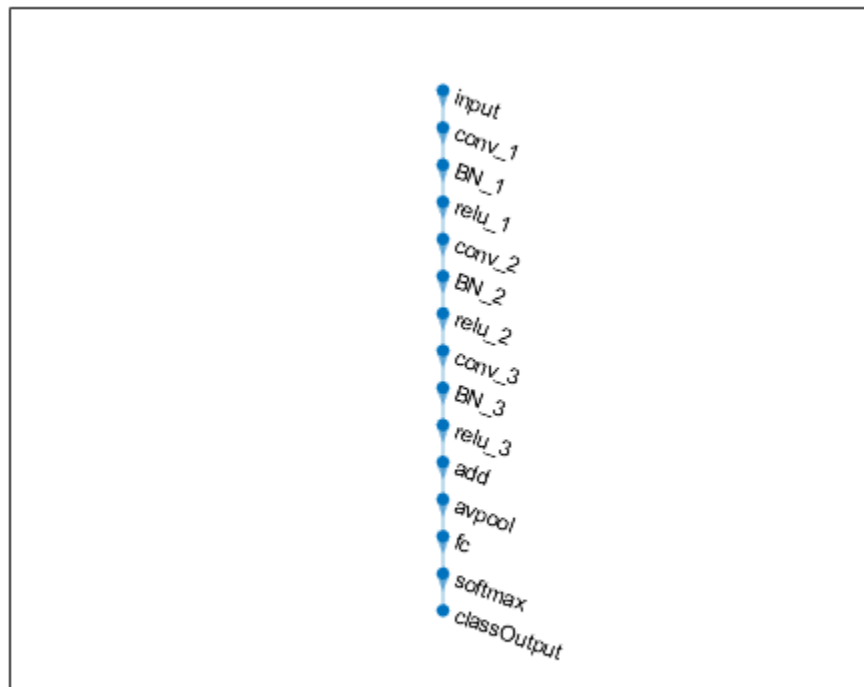

Create the 1-by-1 convolutional layer and add it to the layer graph. Specify the number of convolutional filters and the stride so that the activation size matches the activation size of the 'relu\_3' layer. This arrangement enables the addition layer to add the outputs of the 'skipConv' and 'relu\_3' layers. To check that the layer is in the graph, plot the layer graph.

```

skipConv = convolution2dLayer(1,32,'Stride',2,'Name','skipConv');
lgraph = addLayers(lgraph,skipConv);
figure
plot(lgraph)

```

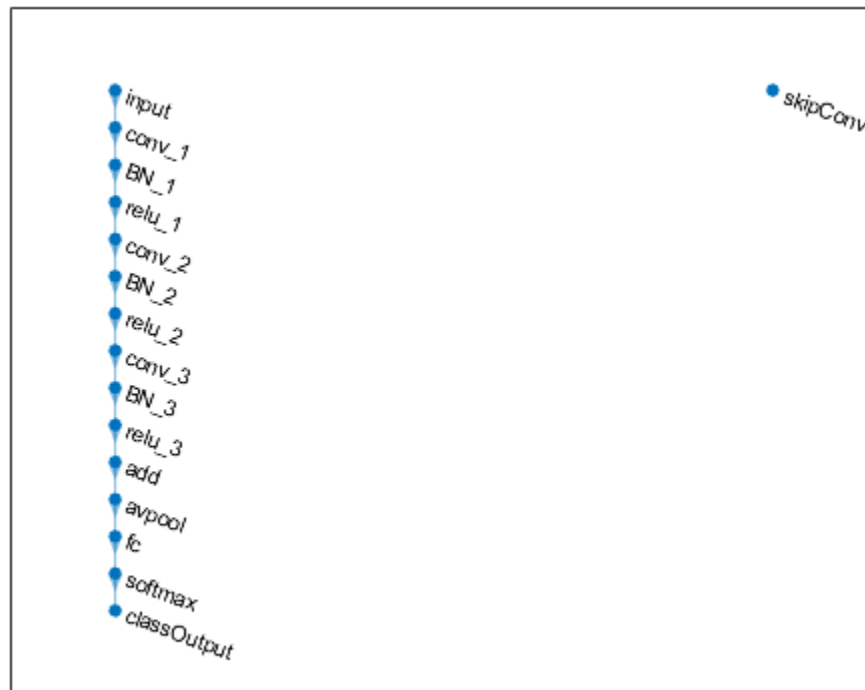

Create the shortcut connection from the 'relu\_1' layer to the 'add' layer. Because you specified two as the number of inputs to the addition layer when you created it, the layer has two inputs named 'in1' and 'in2'. The 'relu\_3' layer is already connected to the 'in1' input. Connect the 'relu\_1' layer to the 'skipConv' layer and the 'skipConv' layer to the 'in2' input of the 'add' layer. The addition layer now sums the outputs of the 'relu\_3' and 'skipConv' layers. To check that the layers are connected correctly, plot the layer graph.

```
lgraph = connectLayers(lgraph, 'relu_1', 'skipConv');  
lgraph = connectLayers(lgraph, 'skipConv', 'add/in2');  
figure  
plot(lgraph);
```

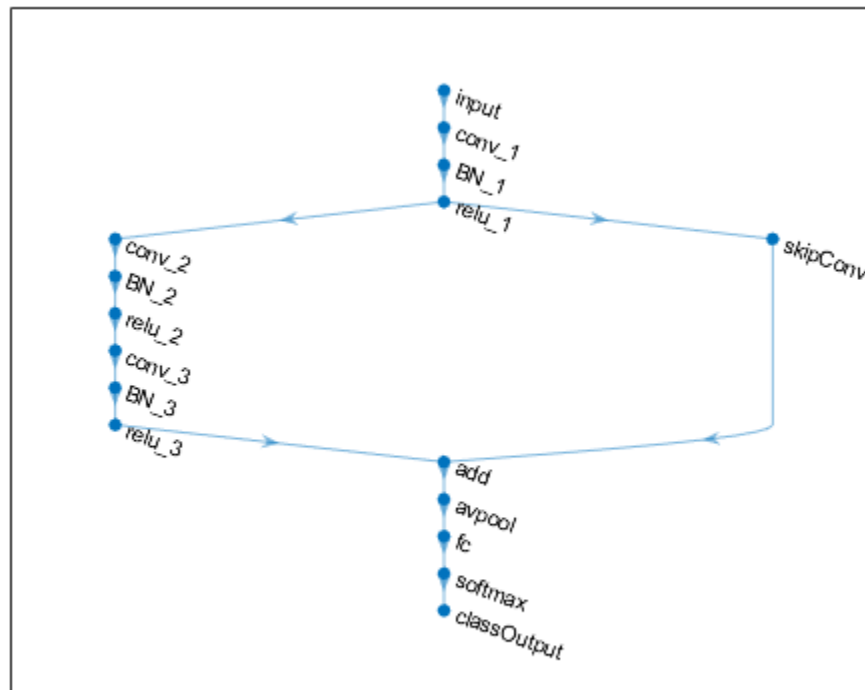

Load the training and validation data, which consists of 28-by-28 grayscale images of digits.

```
[XTrain,YTrain] = digitTrain4DArrayData;
[XValidation,YValidation] = digitTest4DArrayData;
```

Specify training options and train the network. `trainNetwork` validates the network using the validation data every `ValidationFrequency` iterations.

```
options = trainingOptions('sgdm', ...
    'MaxEpochs',8, ...
    'Shuffle','every-epoch', ...
    'ValidationData',{XValidation,YValidation}, ...
    'ValidationFrequency',30, ...
    'Verbose',false, ...
    'Plots','training-progress');
net = trainNetwork(XTrain,YTrain,lgraph,options);
```

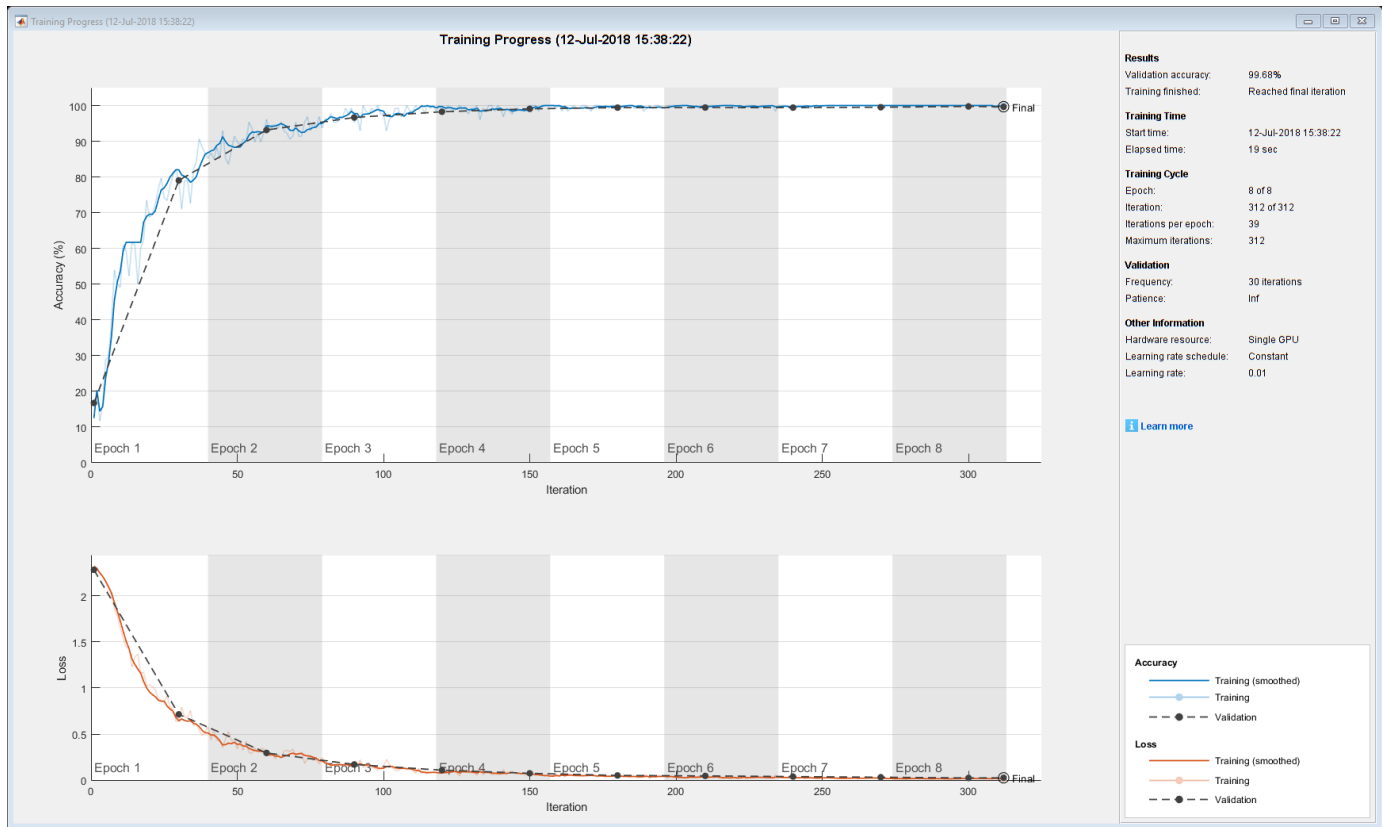

Display the properties of the trained network. The network is a DAGNetwork object.

```
net
net =
  DAGNetwork with properties:
    Layers: [16x1 nnet.cnn.layer.Layer]
    Connections: [16x2 table]
```

Classify the validation images and calculate the accuracy. The network is very accurate.

```
YPredicted = classify(net,XValidation);
accuracy = mean(YPredicted == YValidation)

accuracy = 0.9968
```

## Extended Capabilities

### GPU Code Generation

Generate CUDA® code for NVIDIA® GPUs using GPU Coder™.

### See Also

[depthConcatenationLayer](#) | [layerGraph](#) | [trainNetwork](#)

**Topics**

“Create Simple Deep Learning Network for Classification”  
“Deep Learning in MATLAB”  
“Pretrained Deep Neural Networks”  
“Set Up Parameters and Train Convolutional Neural Network”  
“Specify Layers of Convolutional Neural Network”  
“Train Residual Network for Image Classification”  
“List of Deep Learning Layers”

**Introduced in R2017b**

## addLayers

Add layers to layer graph

### Syntax

```
newLgraph = addLayers(lgraph,larray)
```

### Description

`newLgraph = addLayers(lgraph,larray)` adds the network layers in `larray` to the layer graph `lgraph`. The new layer graph, `newLgraph`, contains the layers and connections of `lgraph` together with the layers in `larray`, connected sequentially. The layer names in `larray` must be unique, nonempty, and different from the names of the layers in `lgraph`.

### Examples

#### Add Layers to Layer Graph

Create an empty layer graph and an array of layers. Add the layers to the layer graph and plot the graph. `addLayers` connects the layers sequentially.

```
lgraph = layerGraph;  
  
layers = [  
    imageInputLayer([32 32 3], 'Name', 'input')  
    convolution2dLayer(3,16, 'Padding', 'same', 'Name', 'conv_1')  
    batchNormalizationLayer('Name', 'BN_1')  
    reluLayer('Name', 'relu_1')];  
  
lgraph = addLayers(lgraph,layers);  
figure  
plot(lgraph)
```



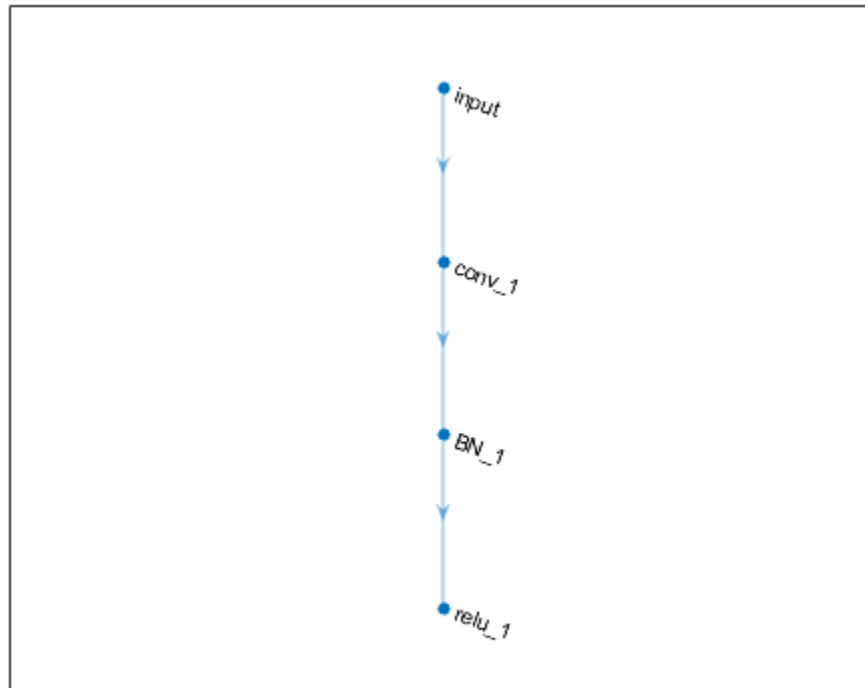

## Input Arguments

### **lgraph** — Layer graph

LayerGraph object

Layer graph, specified as a LayerGraph object. To create a layer graph, use `layerGraph`.

### **larray** — Network layers

Layer array

Network layers, specified as a Layer array.

For a list of built-in layers, see “List of Deep Learning Layers”.

## Output Arguments

### **newlgraph** — Output layer graph

LayerGraph object

Output layer graph, returned as a LayerGraph object.

## See Also

`assembleNetwork` | `connectLayers` | `disconnectLayers` | `layerGraph` | `plot` | `removeLayers` | `replaceLayer`

**Topics**

“Train Residual Network for Image Classification”

“Train Deep Learning Network to Classify New Images”

**Introduced in R2017b**

# alexnet

AlexNet convolutional neural network

## Syntax

```
net = alexnet
net = alexnet('Weights','imagenet')

layers = alexnet('Weights','none')
```

## Description

AlexNet is a convolutional neural network that is 8 layers deep. You can load a pretrained version of the network trained on more than a million images from the ImageNet database [1]. The pretrained network can classify images into 1000 object categories, such as keyboard, mouse, pencil, and many animals. As a result, the network has learned rich feature representations for a wide range of images. The network has an image input size of 227-by-227. For more pretrained networks in MATLAB, see “Pretrained Deep Neural Networks”.

You can use `classify` to classify new images using the AlexNet network. Follow the steps of “Classify Image Using GoogLeNet” and replace GoogLeNet with AlexNet.

For a free hands-on introduction to practical deep learning methods, see Deep Learning Onramp.

`net = alexnet` returns an AlexNet network trained on the ImageNet data set.

This function requires Deep Learning Toolbox Model *for AlexNet Network* support package. If this support package is not installed, the function provides a download link. Alternatively, see Deep Learning Toolbox Model *for AlexNet Network*.

For more pretrained networks in MATLAB, see “Pretrained Deep Neural Networks”.

`net = alexnet('Weights','imagenet')` returns an AlexNet network trained on the ImageNet data set. This syntax is equivalent to `net = alexnet`.

`layers = alexnet('Weights','none')` returns the untrained AlexNet network architecture. The untrained model does not require the support package.

## Examples

### Download AlexNet Support Package

Download and install Deep Learning Toolbox Model *for AlexNet Network* support package.

Type `alexnet` at the command line.

```
alexnet
```

If Deep Learning Toolbox Model *for AlexNet Network* support package is not installed, then the function provides a link to the required support package in the Add-On Explorer. To install the

support package, click the link, and then click **Install**. Check that the installation is successful by typing `alexnet` at the command line.

```
alexnet
ans =
    SeriesNetwork with properties:
        Layers: [25x1 nnet.cnn.layer.Layer]
```

If the required support package is installed, then the function returns a `SeriesNetwork` object.

## Transfer Learning Using AlexNet

This example shows how to fine-tune a pretrained AlexNet convolutional neural network to perform classification on a new collection of images.

AlexNet has been trained on over a million images and can classify images into 1000 object categories (such as keyboard, coffee mug, pencil, and many animals). The network has learned rich feature representations for a wide range of images. The network takes an image as input and outputs a label for the object in the image together with the probabilities for each of the object categories.

Transfer learning is commonly used in deep learning applications. You can take a pretrained network and use it as a starting point to learn a new task. Fine-tuning a network with transfer learning is usually much faster and easier than training a network with randomly initialized weights from scratch. You can quickly transfer learned features to a new task using a smaller number of training images.

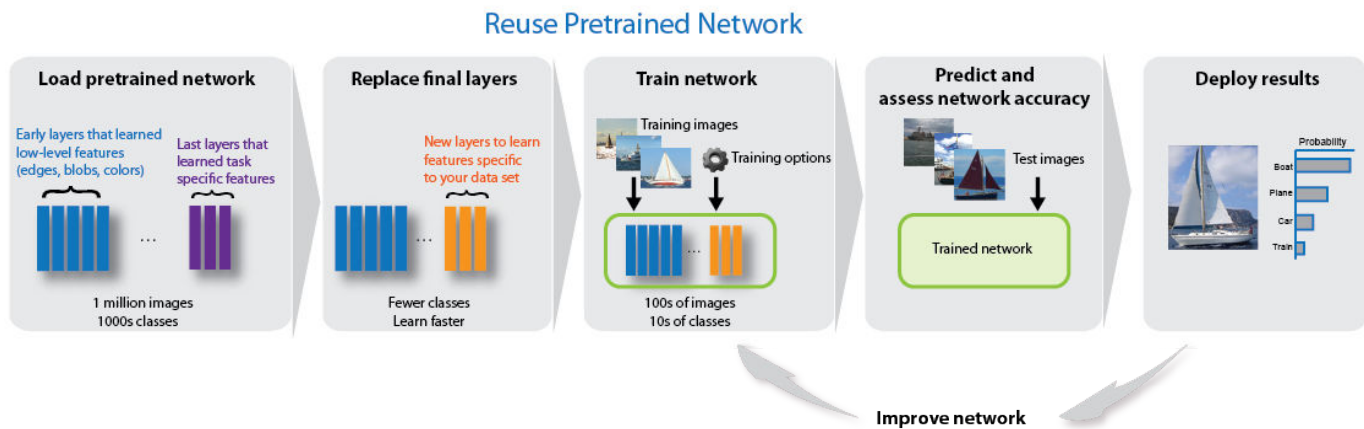

## Load Data

Unzip and load the new images as an image datastore. `imageDatastore` automatically labels the images based on folder names and stores the data as an `ImageDatastore` object. An image datastore enables you to store large image data, including data that does not fit in memory, and efficiently read batches of images during training of a convolutional neural network.

```
unzip('MerchData.zip');
imds = imageDatastore('MerchData', ...
```

```
'IncludeSubfolders',true, ...
'LabelSource','foldernames');
```

Divide the data into training and validation data sets. Use 70% of the images for training and 30% for validation. `splitEachLabel` splits the images datastore into two new datastores.

```
[imdsTrain,imdsValidation] = splitEachLabel(imds,0.7,'randomized');
```

This very small data set now contains 55 training images and 20 validation images. Display some sample images.

```
numTrainImages = numel(imdsTrain.Labels);
idx = randperm(numTrainImages,16);
figure
for i = 1:16
    subplot(4,4,i)
    I = readimage(imdsTrain,idx(i));
    imshow(I)
end
```



## Load Pretrained Network

Load the pretrained AlexNet neural network. If Deep Learning Toolbox™ Model for AlexNet Network is not installed, then the software provides a download link. AlexNet is trained on more than one million images and can classify images into 1000 object categories, such as keyboard, mouse, pencil, and many animals. As a result, the model has learned rich feature representations for a wide range of images.

```
net = alexnet;
```

Use `analyzeNetwork` to display an interactive visualization of the network architecture and detailed information about the network layers.

```
analyzeNetwork(net)
```

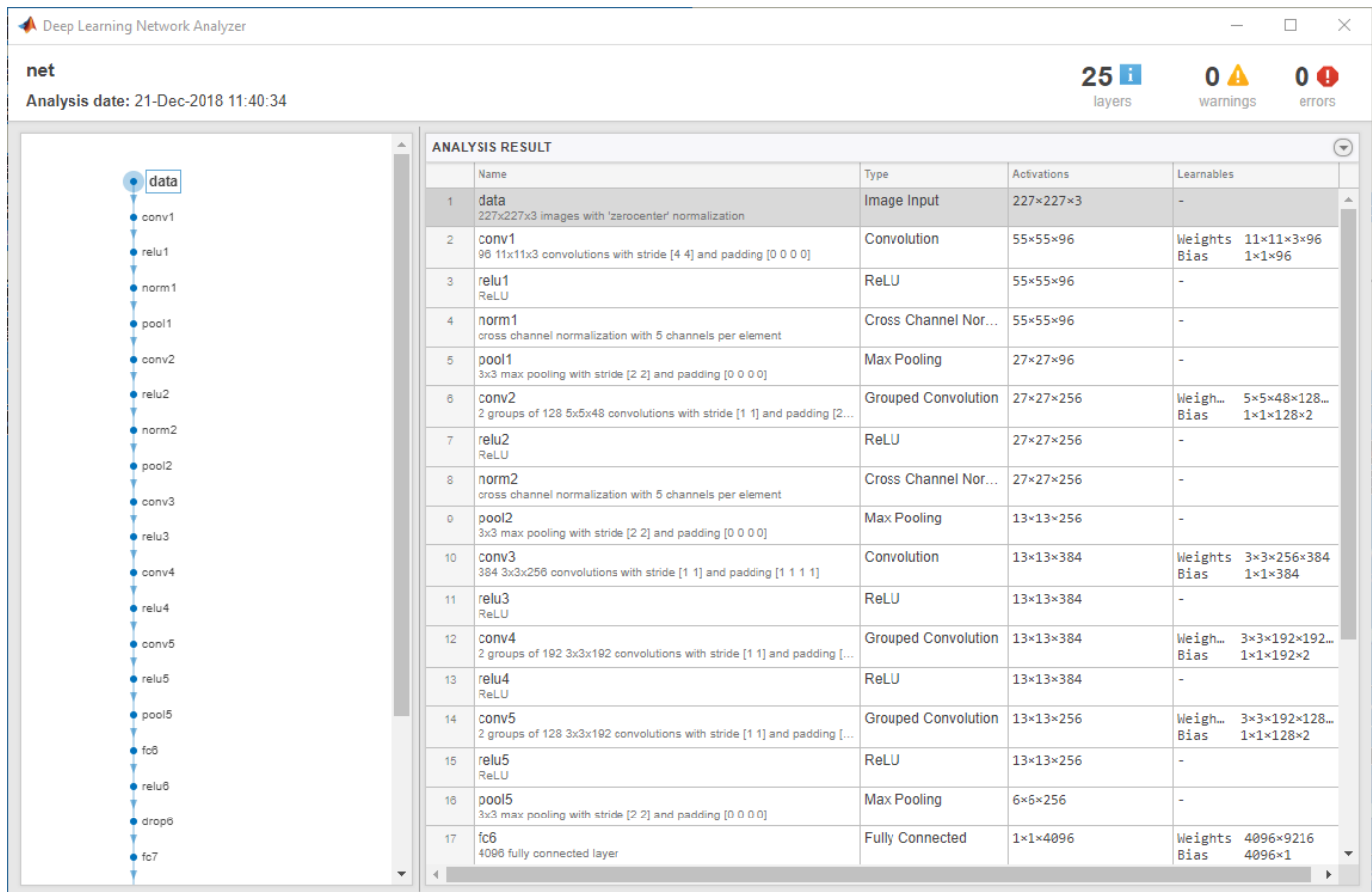

The first layer, the image input layer, requires input images of size 227-by-227-by-3, where 3 is the number of color channels.

```
inputSize = net.Layers(1).InputSize
```

```
inputSize = 1x3
```

```
227 227 3
```

## Replace Final Layers

The last three layers of the pretrained network `net` are configured for 1000 classes. These three layers must be fine-tuned for the new classification problem. Extract all layers, except the last three, from the pretrained network.

```
layersTransfer = net.Layers(1:end-3);
```

Transfer the layers to the new classification task by replacing the last three layers with a fully connected layer, a softmax layer, and a classification output layer. Specify the options of the new fully

connected layer according to the new data. Set the fully connected layer to have the same size as the number of classes in the new data. To learn faster in the new layers than in the transferred layers, increase the `WeightLearnRateFactor` and `BiasLearnRateFactor` values of the fully connected layer.

```
numClasses = numel(categories(imdsTrain.Labels))
numClasses = 5
layers = [
    layersTransfer
    fullyConnectedLayer(numClasses, 'WeightLearnRateFactor', 20, 'BiasLearnRateFactor', 20)
    softmaxLayer
    classificationLayer];
```

### Train Network

The network requires input images of size 227-by-227-by-3, but the images in the image datastores have different sizes. Use an augmented image datastore to automatically resize the training images. Specify additional augmentation operations to perform on the training images: randomly flip the training images along the vertical axis, and randomly translate them up to 30 pixels horizontally and vertically. Data augmentation helps prevent the network from overfitting and memorizing the exact details of the training images.

```
pixelRange = [-30 30];
imageAugmenter = imageDataAugmenter( ...
    'RandXReflection', true, ...
    'RandXTranslation', pixelRange, ...
    'RandYTranslation', pixelRange);
augimdsTrain = augmentedImageDatastore(inputSize(1:2), imdsTrain, ...
    'DataAugmentation', imageAugmenter);
```

To automatically resize the validation images without performing further data augmentation, use an augmented image datastore without specifying any additional preprocessing operations.

```
augimdsValidation = augmentedImageDatastore(inputSize(1:2), imdsValidation);
```

Specify the training options. For transfer learning, keep the features from the early layers of the pretrained network (the transferred layer weights). To slow down learning in the transferred layers, set the initial learning rate to a small value. In the previous step, you increased the learning rate factors for the fully connected layer to speed up learning in the new final layers. This combination of learning rate settings results in fast learning only in the new layers and slower learning in the other layers. When performing transfer learning, you do not need to train for as many epochs. An epoch is a full training cycle on the entire training data set. Specify the mini-batch size and validation data. The software validates the network every `ValidationFrequency` iterations during training.

```
options = trainingOptions('sgdm', ...
    'MiniBatchSize', 10, ...
    'MaxEpochs', 6, ...
    'InitialLearnRate', 1e-4, ...
    'Shuffle', 'every-epoch', ...
    'ValidationData', augimdsValidation, ...
    'ValidationFrequency', 3, ...
    'Verbose', false, ...
    'Plots', 'training-progress');
```

Train the network that consists of the transferred and new layers. By default, `trainNetwork` uses a GPU if one is available (requires Parallel Computing Toolbox™ and a CUDA® enabled GPU with

compute capability 3.0 or higher). Otherwise, it uses a CPU. You can also specify the execution environment by using the 'ExecutionEnvironment' name-value pair argument of trainingOptions.

```
netTransfer = trainNetwork(augimdsTrain, layers, options);
```

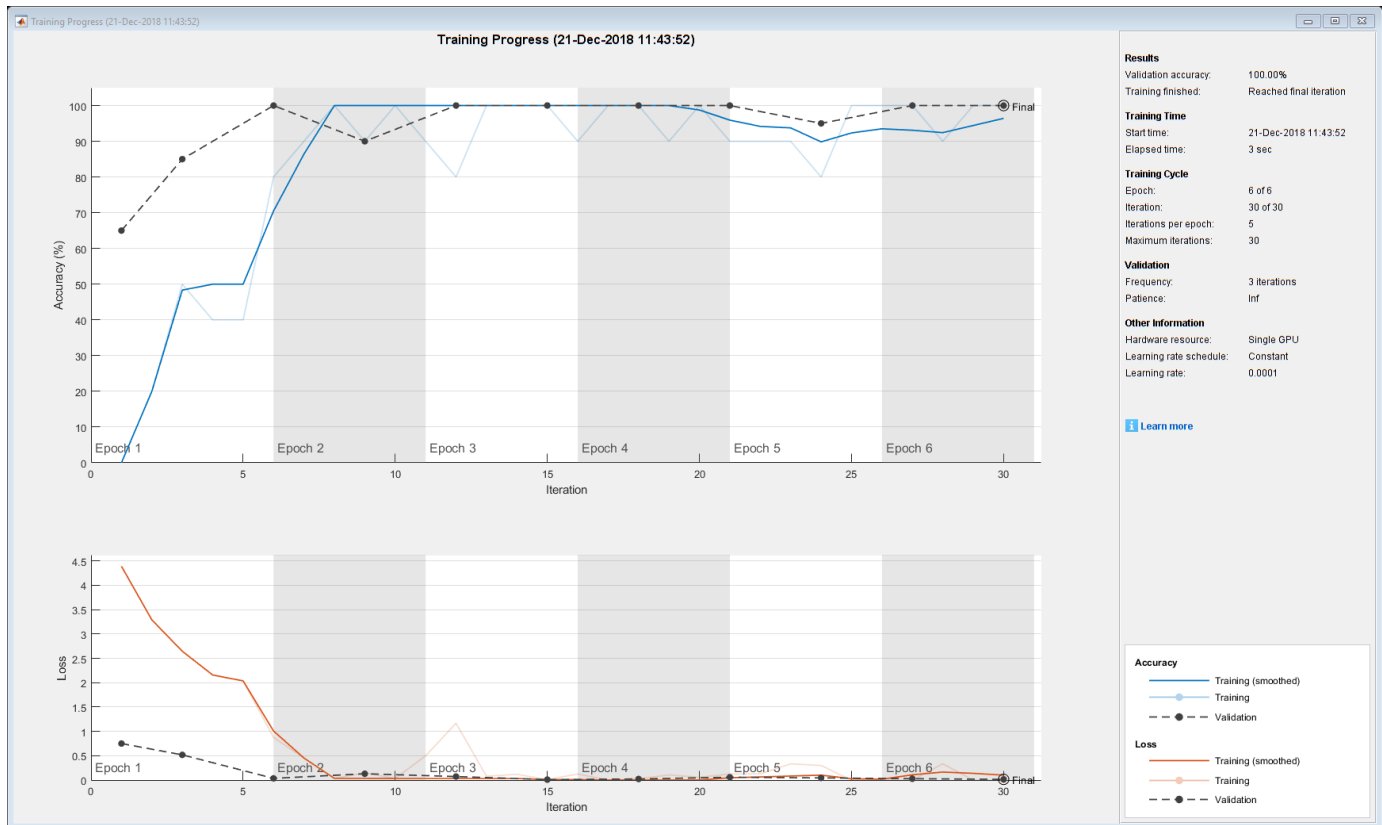

## Classify Validation Images

Classify the validation images using the fine-tuned network.

```
[YPred,scores] = classify(netTransfer,augimdsValidation);
```

Display four sample validation images with their predicted labels.

```
idx = randperm(numel(imdsValidation.Files),4);
figure
for i = 1:4
    subplot(2,2,i)
    I = readimage(imdsValidation,idx(i));
    imshow(I)
    label = YPred(idx(i));
    title(string(label));
end
```

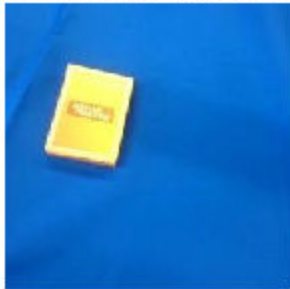

**MathWorks Playing Cards****MathWorks Screwdriver****MathWorks Cap****MathWorks Screwdriver**

Calculate the classification accuracy on the validation set. Accuracy is the fraction of labels that the network predicts correctly.

```
YValidation = imdsValidation.Labels;
accuracy = mean(YPred == YValidation)
```

```
accuracy = 1
```

For tips on improving classification accuracy, see “Deep Learning Tips and Tricks”.

### **Classify an Image Using AlexNet**

Read, resize, and classify an image using AlexNet. First, load a pretrained AlexNet model.

```
net = alexnet;
```

Read the image using `imread`.

```
I = imread('peppers.png');
figure
imshow(I)
```



The pretrained model requires the image size to be the same as the input size of the network. Determine the input size of the network using the `InputSize` property of the first layer of the network.

```
sz = net.Layers(1).InputSize
```

```
sz = 1×3
```

```
227 227 3
```

Crop the image to the input size of the network. Alternatively, you can resize the image using `imresize`.

```
I = I(1:sz(1),1:sz(2),1:sz(3));  
figure  
imshow(I)
```



Classify the image using `classify`.

```
label = classify(net,I)
```

```
label = categorical  
      bell pepper
```

Show the image and classification result together.

```
figure  
imshow(I)  
title(label)
```

**bell pepper**

### Feature Extraction Using AlexNet

This example shows how to extract learned image features from a pretrained convolutional neural network, and use those features to train an image classifier. Feature extraction is the easiest and fastest way to use the representational power of pretrained deep networks. For example, you can train a support vector machine (SVM) using `fitcecoc` (Statistics and Machine Learning Toolbox™) on the extracted features. Because feature extraction only requires a single pass through the data, it is a good starting point if you do not have a GPU to accelerate network training with.

#### Load Data

Unzip and load the sample images as an image datastore. `imageDatastore` automatically labels the images based on folder names and stores the data as an `ImageDatastore` object. An image datastore lets you store large image data, including data that does not fit in memory. Split the data into 70% training and 30% test data.

```
unzip('MerchData.zip');  
  
imds = imageDatastore('MerchData', ...  
    'IncludeSubfolders',true, ...  
    'LabelSource','foldernames');  
  
[imdsTrain,imdsTest] = splitEachLabel(imds,0.7,'randomized');
```

There are now 55 training images and 20 validation images in this very small data set. Display some sample images.

```
numImagesTrain = numel(imdsTrain.Labels);  
idx = randperm(numImagesTrain,16);  
  
for i = 1:16
```

```
I{i} = readimage(imdsTrain,idx(i));  
end  
  
figure  
imshow(imtile(I))
```



### Load Pretrained Network

Load a pretrained AlexNet network. If the Deep Learning Toolbox Model *for AlexNet Network* support package is not installed, then the software provides a download link. AlexNet is trained on more than a million images and can classify images into 1000 object categories. For example,

keyboard, mouse, pencil, and many animals. As a result, the model has learned rich feature representations for a wide range of images.

```
net = alexnet;
```

Display the network architecture. The network has five convolutional layers and three fully connected layers.

```
net.Layers
```

```
ans =
```

```
25x1 Layer array with layers:
```

1	'data'	Image Input	227x227x3 images with 'zerocenter' normalization
2	'conv1'	Convolution	96 11x11x3 convolutions with stride [4 4] and padding
3	'relu1'	ReLU	ReLU
4	'norm1'	Cross Channel Normalization	cross channel normalization with 5 channels per group
5	'pool1'	Max Pooling	3x3 max pooling with stride [2 2] and padding
6	'conv2'	Grouped Convolution	2 groups of 128 5x5x48 convolutions with stride [3 3] and padding
7	'relu2'	ReLU	ReLU
8	'norm2'	Cross Channel Normalization	cross channel normalization with 5 channels per group
9	'pool2'	Max Pooling	3x3 max pooling with stride [2 2] and padding
10	'conv3'	Convolution	384 3x3x256 convolutions with stride [1 1] and padding
11	'relu3'	ReLU	ReLU
12	'conv4'	Grouped Convolution	2 groups of 192 3x3x192 convolutions with stride [3 3] and padding
13	'relu4'	ReLU	ReLU
14	'conv5'	Grouped Convolution	2 groups of 128 3x3x192 convolutions with stride [3 3] and padding
15	'relu5'	ReLU	ReLU
16	'pool5'	Max Pooling	3x3 max pooling with stride [2 2] and padding
17	'fc6'	Fully Connected	4096 fully connected layer
18	'relu6'	ReLU	ReLU
19	'drop6'	Dropout	50% dropout
20	'fc7'	Fully Connected	4096 fully connected layer
21	'relu7'	ReLU	ReLU
22	'drop7'	Dropout	50% dropout
23	'fc8'	Fully Connected	1000 fully connected layer
24	'prob'	Softmax	softmax
25	'output'	Classification Output	crossentropyex with 'tench' and 999 other classes

The first layer, the image input layer, requires input images of size 227-by-227-by-3, where 3 is the number of color channels.

```
inputSize = net.Layers(1).InputSize
```

```
inputSize = 1x3
```

```
227 227 3
```

### Extract Image Features

The network constructs a hierarchical representation of input images. Deeper layers contain higher-level features, constructed using the lower-level features of earlier layers. To get the feature representations of the training and test images, use `activations` on the fully connected layer 'fc7'. To get a lower-level representation of the images, use an earlier layer in the network.

The network requires input images of size 227-by-227-by-3, but the images in the image datastores have different sizes. To automatically resize the training and test images before they are input to the

network, create augmented image datastores, specify the desired image size, and use these datastores as input arguments to `activations`.

```
augimdsTrain = augmentedImageDatastore(inputSize(1:2),imdsTrain);
augimdsTest = augmentedImageDatastore(inputSize(1:2),imdsTest);

layer = 'fc7';
featuresTrain = activations(net,augimdsTrain,layer,'OutputAs','rows');
featuresTest = activations(net,augimdsTest,layer,'OutputAs','rows');
```

Extract the class labels from the training and test data.

```
YTrain = imdsTrain.Labels;
YTest = imdsTest.Labels;
```

### Fit Image Classifier

Use the features extracted from the training images as predictor variables and fit a multiclass support vector machine (SVM) using `fitcecoc` (Statistics and Machine Learning Toolbox).

```
mdl = fitcecoc(featuresTrain,YTrain);
```

### Classify Test Images

Classify the test images using the trained SVM model and the features extracted from the test images.

```
YPred = predict(mdl,featuresTest);
```

Display four sample test images with their predicted labels.

```
idx = [1 5 10 15];
figure
for i = 1:numel(idx)
    subplot(2,2,i)
    I = readimage(imdsTest,idx(i));
    label = YPred(idx(i));

    imshow(I)
    title(label)
end
```

**MathWorks Cap**



**MathWorks Cube**

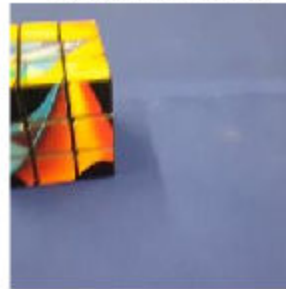

**MathWorks Playing Cards**

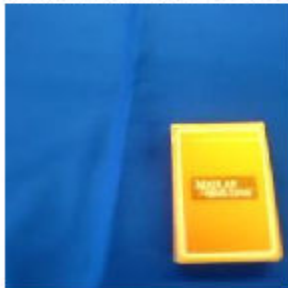

**MathWorks Screwdriver**



Calculate the classification accuracy on the test set. Accuracy is the fraction of labels that the network predicts correctly.

```
accuracy = mean(YPred == YTest)
```

```
accuracy = 1
```

This SVM has high accuracy. If the accuracy is not high enough using feature extraction, then try transfer learning instead.

## Output Arguments

**net** — Pretrained AlexNet convolutional neural network

SeriesNetwork object

Pretrained AlexNet convolutional neural network, returned as a SeriesNetwork object.

**layers** — Untrained AlexNet convolutional neural network architecture

Layer array

Untrained AlexNet convolutional neural network architecture, returned as a Layer array.

## Tips

- For a free hands-on introduction to practical deep learning methods, see Deep Learning Onramp.



## References

- [1] *ImageNet*. <http://www.image-net.org>
- [2] Russakovsky, O., Deng, J., Su, H., et al. "ImageNet Large Scale Visual Recognition Challenge." *International Journal of Computer Vision (IJCV)*. Vol 115, Issue 3, 2015, pp. 211–252
- [3] Krizhevsky, Alex, Ilya Sutskever, and Geoffrey E. Hinton. "ImageNet Classification with Deep Convolutional Neural Networks." *Advances in neural information processing systems*. 2012.
- [4] *BVLC AlexNet Model*. [https://github.com/BVLC/caffe/tree/master/models/bvlc\\_alexnet](https://github.com/BVLC/caffe/tree/master/models/bvlc_alexnet)

## Extended Capabilities

### C/C++ Code Generation

Generate C and C++ code using MATLAB® Coder™.

For code generation, you can load the network by using the syntax `net = alexnet` or by passing the `alexnet` function to `coder.loadDeepLearningNetwork`. For example: `net = coder.loadDeepLearningNetwork('alexnet')`.

For more information, see “Load Pretrained Networks for Code Generation” (MATLAB Coder).

The syntax `alexnet('Weights', 'none')` is not supported for code generation.

### GPU Code Generation

Generate CUDA® code for NVIDIA® GPUs using GPU Coder™.

Usage notes and limitations:

- For code generation, you can load the network by using the syntax `net = alexnet` or by passing the `alexnet` function to `coder.loadDeepLearningNetwork`. For example: `net = coder.loadDeepLearningNetwork('alexnet')`.

For more information, see “Load Pretrained Networks for Code Generation” (GPU Coder).

- The syntax `alexnet('Weights', 'none')` is not supported for GPU code generation.

## See Also

**Deep Network Designer** | `densenet201` | `googlenet` | `importCaffeNetwork` | `importKerasNetwork` | `inceptionresnetv2` | `resnet18` | `resnet50` | `squeezenet` | `vgg16` | `vgg19`

### Topics

“Deep Learning in MATLAB”  
 “Classify Webcam Images Using Deep Learning”  
 “Pretrained Deep Neural Networks”  
 “Train Deep Learning Network to Classify New Images”  
 “Visualize Features of a Convolutional Neural Network”  
 “Visualize Activations of a Convolutional Neural Network”  
 “Deep Learning Tips and Tricks”

### Introduced in R2017a

# analyzeNetwork

Analyze deep learning network architecture

## Syntax

```
analyzeNetwork(layers)
```

## Description

`analyzeNetwork(layers)` analyzes the deep learning network architecture specified by `layers`. The `analyzeNetwork` function displays an interactive visualization of the network architecture, detects errors and issues in the network, and provides detailed information about the network layers. The layer information includes the sizes of layer activations and learnable parameters, the total number of learnable parameters, and the sizes of state parameters of recurrent layers.

Use the network analyzer to visualize and understand the network architecture, check that you have defined the architecture correctly, and detect problems before training. Problems that `analyzeNetwork` detects include missing or unconnected layers, incorrectly sized layer inputs, an incorrect number of layer inputs, and invalid graph structures.

## Examples

### Analyze Trained Network

Load a pretrained GoogLeNet convolutional neural network.

```
net = googlenet
net =
  DAGNetwork with properties:
    Layers: [144x1 nnet.cnn.layer.Layer]
    Connections: [170x2 table]
```

Analyze the network. `analyzeNetwork` displays an interactive plot of the network architecture and a table containing information about the network layers.

Investigate the network architecture using the plot to the left. Select a layer in the plot. The selected layer is highlighted in the plot and in the layer table.

In the table, view layer information such as layer properties, layer type, and sizes of the layer activations and learnable parameters. The activations of a layer are the outputs of that layer.

Select a deeper layer in the network. Notice that activations in deeper layers are smaller in the spatial dimensions (the first two dimensions) and larger in the channel dimension (the last dimension). Using this structure enables convolutional neural networks to gradually increase the number of extracted image features while decreasing the spatial resolution.

Show the total number of learnable parameters in each layer by clicking the arrow in the top-right corner of the layer table and select **Total Learnables**. To sort the layer table by column value, hover

the mouse over the column heading and click the arrow that appears. For example, you can determine which layer contains the most parameters by sorting the layers by the total number of learnable parameters.

```
analyzeNetwork(net)
```

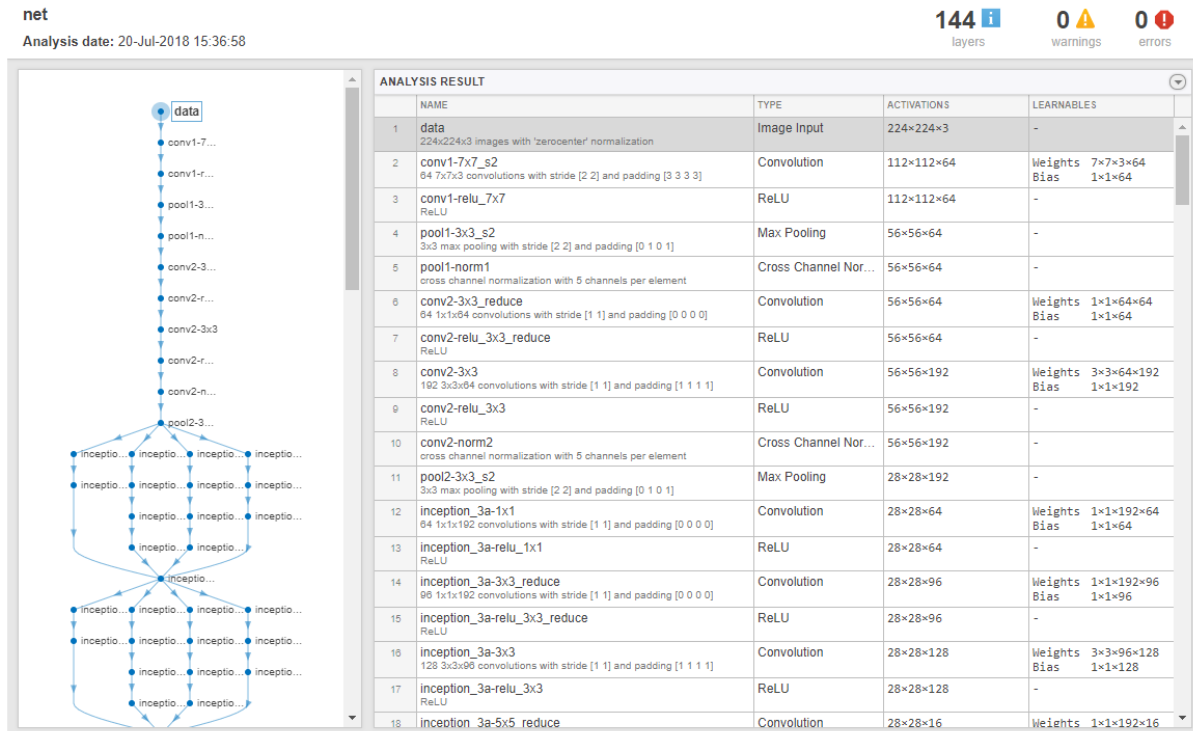

## Fix Errors in Network Architecture

Create a simple convolutional network with shortcut connections. Create the main branch of the network as an array of layers and create a layer graph from the layer array. `LayerGraph` connects all the layers in `layers` sequentially.

```
layers = [
    imageInputLayer([32 32 3], 'Name', 'input')

    convolution2dLayer(5,16, 'Padding', 'same', 'Name', 'conv_1')
    reluLayer('Name', 'relu_1')

    convolution2dLayer(3,16, 'Padding', 'same', 'Stride', 2, 'Name', 'conv_2')
    reluLayer('Name', 'relu_2')
    additionLayer(2, 'Name', 'add1')

    convolution2dLayer(3,16, 'Padding', 'same', 'Stride', 2, 'Name', 'conv_3')
    reluLayer('Name', 'relu_3')
```

```

additionLayer(3, 'Name', 'add2')

fullyConnectedLayer(10, 'Name', 'fc')
classificationLayer('Name', 'output']);
    
```

```
lgraph = layerGraph(layers);
```

Create the shortcut connections. One of the shortcut connections contains a single 1-by-1 convolutional layer skipConv.

```

skipConv = convolution2dLayer(1,16, 'Stride',2, 'Name', 'skipConv');
lgraph = addLayers(lgraph, skipConv);
lgraph = connectLayers(lgraph, 'relu_1', 'add1/in2');
lgraph = connectLayers(lgraph, 'add1', 'add2/in2');
    
```

Analyze the network architecture. analyzeNetwork finds four errors in the network.

```
analyzeNetwork(lgraph)
```

The screenshot shows the MATLAB Network Analyzer interface. On the left is a layer graph with nodes: input, conv\_1, relu\_1, conv\_2, relu\_2, conv\_3, relu\_3, add1, conv\_3, relu\_3, add2, fc, and output. A legend indicates that a red dot represents 'skipConv'. On the right, the 'ISSUES' table lists four errors:

FOUND IN	MESSAGE
output	Missing softmax layer. A classification layer must be preceded by a softmax layer.
skipConv	Disconnected layers. All layers in the layer graph must be connected. Detected disconnected layers: layer 'skipConv'
add2	Missing input. Each layer input must be connected to the output of another layer. Detected missing inputs: input 'in3'
add1	Input size mismatch. Size of input to this layer is different from the expected input size. Inputs to this layer: from layer 'relu_2' (16×16×16 output) from layer 'relu_1' (32×32×16 output)

Below the issues table is the 'ANALYSIS RESULT' table:

NAME	TYPE	ACTIVATIONS	LEARNABLES
1 input 32×32×3 images with 'zerocenter' normalization	Image Input	32×32×3	-
2 conv_1 18 5×5×3 convolutions with stride [1 1] and padding 'same'	Convolution	32×32×16	Weights 5×5×3×16 Bias 1×1×16
3 relu_1 ReLU	ReLU	32×32×16	-
4 conv_2 16 3×3×16 convolutions with stride [2 2] and padding 'same'	Convolution	16×16×16	Weights 3×3×16×16 Bias 1×1×16
5 relu_2 ReLU	ReLU	16×16×16	-
6 add1 Element-wise addition of 2 inputs	Addition	Unknown	-
7 conv_3 18 3×3×0 convolutions with stride [2 2] and padding 'same'	Convolution	Unknown	Weights Bias
8 relu_3 ReLU	ReLU	Unknown	-
9 add2 Element-wise addition of 3 inputs	Addition	Unknown	-
10 fc 10 fully connected layer	Fully Connected	1×1×10	Weights Unknown Bias 10×1

Investigate and fix the errors in the network. In this example, the following issues cause the errors:

- A softmax layer, which outputs class probabilities, must precede the classification layer. To fix the error in the output classification layer, add a softmax layer before the classification layer.
- The skipConv layer is not connected to the rest of the network. It should be a part of the shortcut connection between the add1 and add2 layers. To fix this error, connect add1 to skipConv and skipConv to add2.

- The `add2` layer is specified to have three inputs, but the layers only has two inputs. To fix the error, specify the number of inputs as 2.
- All the inputs to an addition layer must have the same size, but the `add1` layer has two inputs with different sizes. Because the `conv_2` layer has a `'Stride'` value of 2, this layer downsamples the activations by a factor of two in the first two dimensions (the spatial dimensions). To resize the input from the `relu2` layer so that it has the same size as the input from `relu1`, remove the downsampling by setting the `'Stride'` value of the `conv_2` layer to 1.

Apply these modifications to the layer graph construction from the beginning of this example and create a new layer graph.

```
layers = [
    imageInputLayer([32 32 3], 'Name', 'input')

    convolution2dLayer(5,16, 'Padding', 'same', 'Name', 'conv_1')
    reluLayer('Name', 'relu_1')

    convolution2dLayer(3,16, 'Padding', 'same', 'Stride', 1, 'Name', 'conv_2')
    reluLayer('Name', 'relu_2')
    additionLayer(2, 'Name', 'add1')

    convolution2dLayer(3,16, 'Padding', 'same', 'Stride', 2, 'Name', 'conv_3')
    reluLayer('Name', 'relu_3')
    additionLayer(2, 'Name', 'add2')

    fullyConnectedLayer(10, 'Name', 'fc')
    softmaxLayer('Name', 'softmax');
    classificationLayer('Name', 'output')];

lgraph = layerGraph(layers);

skipConv = convolution2dLayer(1,16, 'Stride', 2, 'Name', 'skipConv');
lgraph = addLayers(lgraph, skipConv);
lgraph = connectLayers(lgraph, 'relu_1', 'add1/in2');
lgraph = connectLayers(lgraph, 'add1', 'skipConv');
lgraph = connectLayers(lgraph, 'skipConv', 'add2/in2');
```

Analyze the new architecture. The new network does not contain any errors and is ready to be trained.

```
analyzeNetwork(lgraph)
```

Igraph

Analysis date: 24-Oct-2018 16:20:24

13 layers

0 warnings

0 errors

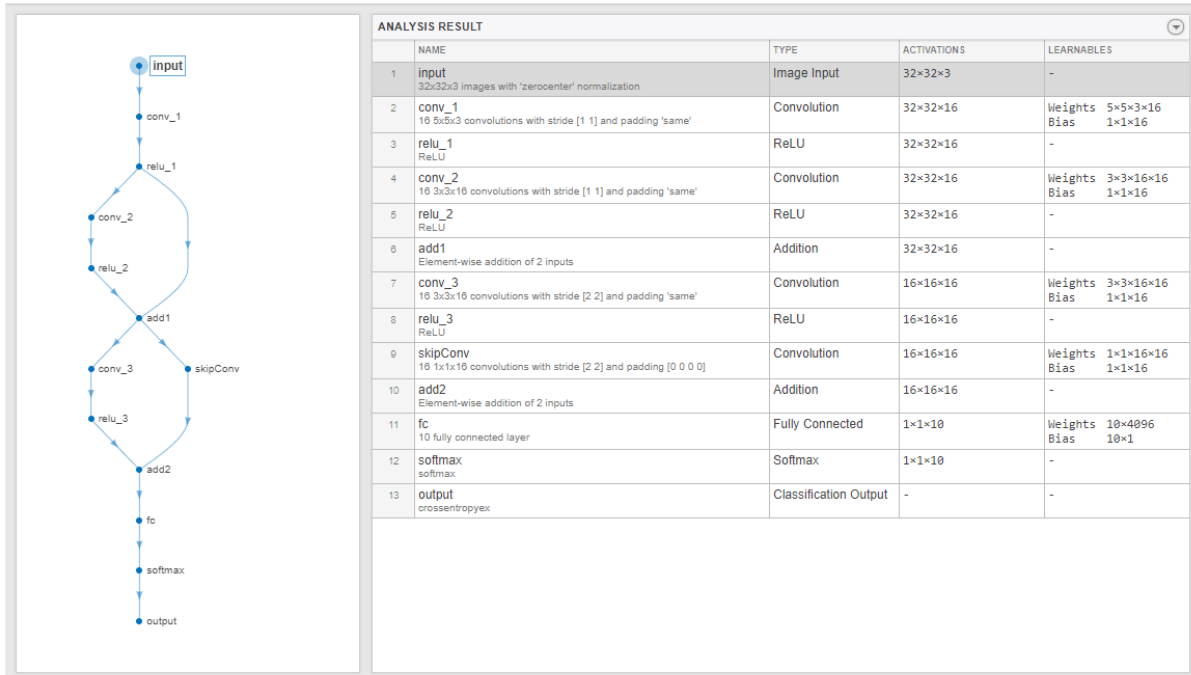

## Input Arguments

### Layers — Network architecture

Layer array | LayerGraph object | SeriesNetwork object | DAGNetwork object

Network architecture, specified as a Layer array, LayerGraph object, SeriesNetwork object, or DAGNetwork object.

## See Also

DAGNetwork | **Deep Network Designer** | LayerGraph | SeriesNetwork | assembleNetwork | plot | trainNetwork

## Topics

- “Create Simple Deep Learning Network for Classification”
- “Transfer Learning with Deep Network Designer”
- “Build Networks with Deep Network Designer”
- “Train Deep Learning Network to Classify New Images”
- “Pretrained Deep Neural Networks”
- “Visualize Activations of a Convolutional Neural Network”
- “Deep Learning in MATLAB”

**Introduced in R2018a**

# assembleNetwork

Assemble deep learning network from pretrained layers

## Syntax

```
assembledNet = assembleNetwork(layers)
```

## Description

`assembleNetwork` creates deep learning networks from layers without training.

Use `assembleNetwork` for the following tasks:

- Convert a layer array or layer graph to a network ready for prediction.
- Assemble networks from imported layers.
- Modify the weights of a trained network.

To train a network from scratch, use `trainNetwork`.

`assembledNet = assembleNetwork(layers)` assembles the layer array or layer graph `layers` into a deep learning network ready to use for prediction.

## Examples

### Assemble Network from Pretrained Keras Layers

Import the layers from a pretrained Keras network, replace the unsupported layers with custom layers, and assemble the layers into a network ready for prediction.

#### Import Keras Network

Import the layers from a Keras network model. The network in `'digitsDAGnetwithnoise.h5'` classifies images of digits.

```
filename = 'digitsDAGnetwithnoise.h5';
lgraph = importKerasLayers(filename, 'ImportWeights', true);
```

Warning: Unable to import some Keras layers, because they are not yet supported by the Deep Learning Toolbox™.

The Keras network contains some layers that are not supported by Deep Learning Toolbox™. The `importKerasLayers` function displays a warning and replaces the unsupported layers with placeholder layers.

#### Replace Placeholder Layers

To replace the placeholder layers, first identify the names of the layers to replace. Find the placeholder layers using `findPlaceholderLayers` and display their Keras configurations.

```
placeholderLayers = findPlaceholderLayers(lgraph);
placeholderLayers.KerasConfiguration
```

```
ans = struct with fields:
  trainable: 1
  name: 'gaussian_noise_1'
  stddev: 1.5000

ans = struct with fields:
  trainable: 1
  name: 'gaussian_noise_2'
  stddev: 0.7000
```

Define a custom Gaussian noise layer by saving the file `gaussianNoiseLayer.m` in the current folder. Then, create two Gaussian noise layers with the same configurations as the imported Keras layers.

```
gnLayer1 = gaussianNoiseLayer(1.5, 'new_gaussian_noise_1');
gnLayer2 = gaussianNoiseLayer(0.7, 'new_gaussian_noise_2');
```

Replace the placeholder layers with the custom layers using `replaceLayer`.

```
lgraph = replaceLayer(lgraph, 'gaussian_noise_1', gnLayer1);
lgraph = replaceLayer(lgraph, 'gaussian_noise_2', gnLayer2);
```

### Specify Class Names

The imported classification layer does not contain the classes, so you must specify these before assembling the network. If you do not specify the classes, then the software automatically sets the classes to 1, 2, ..., N, where N is the number of classes.

The classification layer has the name `'ClassificationLayer_activation_1'`. Set the classes to 0, 1, ..., 9, and then replace the imported classification layer with the new one.

```
cLayer = lgraph.Layers(end);
cLayer.Classes = string(0:9);
lgraph = replaceLayer(lgraph, 'ClassificationLayer_activation_1', cLayer);
```

### Assemble Network

Assemble the layer graph using `assembleNetwork`. The function returns a `DAGNetwork` object that is ready to use for prediction.

```
net = assembleNetwork(lgraph)

net =
  DAGNetwork with properties:

    Layers: [15x1 nnet.cnn.layer.Layer]
  Connections: [15x2 table]
```

## Input Arguments

### layers — Network layers

Layer array | LayerGraph object

Network layers, specified as a Layer array or a LayerGraph object.



To create a network with all layers connected sequentially, you can use a `Layer` array as the input argument. In this case, the returned network is a `SeriesNetwork` object.

A directed acyclic graph (DAG) network has a complex structure in which layers can have multiple inputs and outputs. To create a DAG network, specify the network architecture as a `LayerGraph` object and then use that layer graph as the input argument to `assembleNetwork`.

For a list of built-in layers, see “List of Deep Learning Layers”.

## Output Arguments

### **assembledNet** — Assembled network

`SeriesNetwork` object | `DAGNetwork` object

Assembled network ready for prediction, returned as a `SeriesNetwork` object or a `DAGNetwork` object. The returned network depends on the `layers` input argument:

- If `layers` is a `Layer` array, then `assembledNet` is a `SeriesNetwork` object.
- If `layers` is a `LayerGraph` object, then `assembledNet` is a `DAGNetwork` object.

## See Also

`findPlaceholderLayers` | `importKerasLayers` | `importKerasNetwork` | `replaceLayer` | `trainNetwork`

### Topics

“Assemble Network from Pretrained Keras Layers”

“Deep Learning in MATLAB”

“Pretrained Deep Neural Networks”

“Define Custom Deep Learning Layers”

### Introduced in R2018b

## augment

Apply identical random transformations to multiple images

### Syntax

```
augI = augment(augmenter,I)
```

### Description

`augI = augment(augmenter,I)` augments image `I` using a random transformation from the set of image preprocessing options defined by image data augmenter, `augmenter`. If `I` consists of multiple images, then `augment` applies an identical transformation to all images.

### Examples

#### Augment Image Data with Custom Rotation Range

Create an image augmenter that rotates images by a random angle. To use a custom range of valid rotation angles, you can specify a function handle when you create the augmenter. This example specifies a function called `myrange` (defined at the end of the example) that selects an angle from within two disjoint intervals.

```
imageAugmenter = imageDataAugmenter('RandRotation',@myrange);
```

Read multiple images into the workspace, and display the images.

```
img1 = imread('peppers.png');  
img2 = imread('corn.tif',2);  
inImg = imtile({img1,img2});  
imshow(inImg)
```



Augment the images with identical augmentations. The randomly selected rotation angle is returned in a temporary variable, `angle`.

```
outCellArray = augment(imageAugmenter, {img1, img2});
```

```
angle = 8.1158
```

View the augmented images.

```
outImg = imtile(outCellArray);
imshow(outImg);
```



### Supporting Function

This example defines the `myrange` function that first randomly selects one of two intervals (-10, 10) and (170, 190) with equal probability. Within the selected interval, the function returns a single random number from a uniform distribution.

```
function angle = myrange()
    if randi([0 1],1)
        a = -10;
        b = 10;
    else
        a = 170;
        b = 190;
    end
    angle = a + (b-a).*rand(1)
end
```

### Input Arguments

#### **augmenter** — Augmentation options

`imageDataAugmenter` object

Augmentation options, specified as an `imageDataAugmenter` object.

## I – Images to augment

numeric array | cell array of numeric and categorical images

Images to augment, specified as one of the following.

- Numeric array, representing a single grayscale or color image.
- Cell array of numeric and categorical images. Images can be different sizes and types.

## Output Arguments

### augI – Augmented images

numeric array | cell array of numeric and categorical images

Augmented images, returned as a numeric array or cell array of numeric and categorical images, consistent with the format of the input images I.

## Tips

- You can use the `augment` function to preview the transformations applied to sample images.
- To perform image augmentation during training, create an `augmentedImageDatastore` and specify preprocessing options by using the `'DataAugmentation'` name-value pair with an `imageDataAugmenter`. The augmented image datastore automatically applies random transformations to the training data.

## See Also

`augmentedImageDatastore` | `trainNetwork`

## Topics

“Deep Learning in MATLAB”

“Preprocess Images for Deep Learning”

**Introduced in R2018b**

# augmentedImageDatastore

Transform batches to augment image data

## Description

An augmented image datastore transforms batches of training, validation, test, and prediction data, with optional preprocessing such as resizing, rotation, and reflection. Resize images to make them compatible with the input size of your deep learning network. Augment training image data with randomized preprocessing operations to help prevent the network from overfitting and memorizing the exact details of the training images.

To train a network using augmented images, supply the `augmentedImageDatastore` to `trainNetwork`. For more information, see “Preprocess Images for Deep Learning”.

- When you use an augmented image datastore as a source of training images, the datastore randomly perturbs the training data for each epoch, so that each epoch uses a slightly different data set. The actual number of training images at each epoch does not change. The transformed images are not stored in memory.
- An `imageInputLayer` normalizes images using the mean of the augmented images, not the mean of the original data set. This mean is calculated once for the first augmented epoch. All other epochs use the same mean, so that the average image does not change during training.

By default, an `augmentedImageDatastore` only resizes images to fit the output size. You can configure options for additional image transformations using an `imageDataAugmenter`.

## Creation

### Syntax

```

auids = augmentedImageDatastore(outputSize,uids)
auids = augmentedImageDatastore(outputSize,X,Y)
auids = augmentedImageDatastore(outputSize,X)
auids = augmentedImageDatastore(outputSize,tbl)
auids = augmentedImageDatastore(outputSize,tbl,responseName)
auids = augmentedImageDatastore( ___,Name,Value)

```

### Description

`auids = augmentedImageDatastore(outputSize,uids)` creates an augmented image datastore for classification problems using images from image datastore `uids`, and sets the `OutputSize` property.

`auids = augmentedImageDatastore(outputSize,X,Y)` creates an augmented image datastore for classification and regression problems. The array `X` contains the predictor variables and the array `Y` contains the categorical labels or numeric responses.

`auids = augmentedImageDatastore(outputSize,X)` creates an augmented image datastore for predicting responses of image data in array `X`.

`auimds = augmentedImageDatastore(outputSize,tbl)` creates an augmented image datastore for classification and regression problems. The table, `tbl`, contains predictors and responses.

`auimds = augmentedImageDatastore(outputSize,tbl,responseName)` creates an augmented image datastore for classification and regression problems. The table, `tbl`, contains predictors and responses. The `responseName` argument specifies the response variables in `tbl`.

`auimds = augmentedImageDatastore( ____,Name,Value)` creates an augmented image datastore, using name-value pairs to set the `ColorPreprocessing`, `DataAugmentation`, `OutputSizeMode`, and `DispatchInBackground` properties. You can specify multiple name-value pairs. Enclose each property name in quotes.

For example,  
`augmentedImageDatastore([28,28],myTable,'OutputSizeMode','centercrop')` creates an augmented image datastore that crops images from the center.

### Input Arguments

#### **imds** — Image datastore

`ImageDatastore` object

Image datastore, specified as an `ImageDatastore` object.

`ImageDatastore` allows batch reading of JPG or PNG image files using prefetching. If you use a custom function for reading the images, then `ImageDatastore` does not prefetch.

---

**Tip** Use `augmentedImageDatastore` for efficient preprocessing of images for deep learning including image resizing.

---

Do not use the `readFcn` option of `imageDatastore` as this option is usually significantly slower.

---

#### **X** — Images

4-D numeric array

Images, specified as a 4-D numeric array. The first three dimensions are the height, width, and channels, and the last dimension indexes the individual images.

If the array contains NaNs, then they are propagated through the training. However, in most cases, the training fails to converge.

Data Types: `single` | `double` | `uint8` | `int8` | `uint16` | `int16` | `uint32` | `int32`

#### **Y** — Responses for classification or regression

array of categorical responses | numeric matrix | 4-D numeric array

Responses for classification or regression, specified as one of the following:

- For a classification problem, `Y` is a categorical vector containing the image labels.
- For a regression problem, `Y` can be an:
  - $n$ -by- $r$  numeric matrix.  $n$  is the number of observations and  $r$  is the number of responses.
  - $h$ -by- $w$ -by- $c$ -by- $n$  numeric array.  $h$ -by- $w$ -by- $c$  is the size of a single response and  $n$  is the number of observations.

Responses must not contain NaNs.

Data Types: `categorical` | `double`

### **tbl — Input data**

`table`

Input data, specified as a table. `tbl` must contain the predictors in the first column as either absolute or relative image paths or images. The type and location of the responses depend on the problem:

- For a classification problem, the response must be a categorical variable containing labels for the images. If the name of the response variable is not specified in the call to `augmentedImageDatastore`, the responses must be in the second column. If the responses are in a different column of `tbl`, then you must specify the response variable name using the `responseName` positional argument.
- For a regression problem, the responses must be numerical values in the column or columns after the first one. The responses can be either in multiple columns as scalars or in a single column as numeric vectors or cell arrays containing numeric 3-D arrays. When you do not specify the name of the response variable or variables, `augmentedImageDatastore` accepts the remaining columns of `tbl` as the response variables. You can specify the response variable names using the `responseName` positional argument.

Responses must not contain NaNs. If there are NaNs in the predictor data, they are propagated through the training, however, in most cases the training fails to converge.

Data Types: `table`

### **responseName — Names of response variables in the input table**

`character vector` | `cell array of character vectors` | `string array`

Names of the response variables in the input table, specified as a character vector, cell array of character vectors, or a string array. For problems with one response, `responseName` is the corresponding variable name in `tbl`. For regression problems with multiple response variables, `responseName` is an array of the corresponding variable names in `tbl`.

Data Types: `char` | `cell` | `string`

## **Properties**

### **ColorPreprocessing — Preprocessing color operations**

`'none'` (default) | `'gray2rgb'` | `'rgb2gray'`

Preprocessing color operations performed on input grayscale or RGB images, specified as `'none'`, `'gray2rgb'`, or `'rgb2gray'`. When the image datastore contains a mixture of grayscale and RGB images, use `ColorPreprocessing` to ensure that all output images have the number of channels required by `imageInputLayer`.

No color preprocessing operation is performed when an input image already has the required number of color channels. For example, if you specify the value `'gray2rgb'` and an input image already has three channels, then no color preprocessing occurs.

---

**Note** The `augmentedImageDatastore` object converts RGB images to grayscale by using the `rgb2gray` function. If an image has three channels that do not correspond to red, green, and blue

channels (such as an image in the L\*a\*b\* color space), then using `ColorPreprocessing` can give poor results.

---

No color preprocessing operation is performed when the input images do not have 1 or 3 channels, such as for multispectral or hyperspectral images. In this case, all input images must have the same number of channels.

Data Types: `char` | `string`

### **DataAugmentation — Preprocessing applied to input images**

'none' (default) | `imageDataAugmenter` object

Preprocessing applied to input images, specified as an `imageDataAugmenter` object or 'none'. When `DataAugmentation` is 'none', no preprocessing is applied to input images.

### **DispatchInBackground — Dispatch observations in background**

false (default) | `true`

Dispatch observations in the background during training, prediction, or classification, specified as `false` or `true`. To use background dispatching, you must have Parallel Computing Toolbox.

Augmented image datastores only perform background dispatching when used with `trainNetwork` and inference functions such as `predict` and `classify`. Background dispatching does not occur when you call the `read` function of the datastore directly.

### **MiniBatchSize — Number of observations in each batch**

128 | positive integer

Number of observations that are returned in each batch. You can change the value of `MiniBatchSize` only after you create the datastore. For training, prediction, and classification, the `MiniBatchSize` property is set to the mini-batch size defined in `trainingOptions`.

### **NumObservations — Total number of observations in the datastore**

positive integer

This property is read-only.

Total number of observations in the augmented image datastore. The number of observations is the length of one training epoch.

### **OutputSize — Size of output images**

vector of two positive integers

Size of output images, specified as a vector of two positive integers. The first element specifies the number of rows in the output images, and the second element specifies the number of columns.

---

**Note** If you create an `augmentedImageDatastore` by specifying the image output size as a three-element vector, then the datastore ignores the third element. Instead, the datastore uses the value of `ColorPreprocessing` to determine the dimensionality of output images. For example, if you specify `OutputSize` as `[28 28 1]` but set `ColorPreprocessing` as `'gray2rgb'`, then the output images have size 28-by-28-by-3.

---



**OutputSizeMode — Method used to resize output images**`'resize' (default) | 'centercrop' | 'randcrop'`

Method used to resize output images, specified as one of the following.

- `'resize'` — Scale the image using bilinear interpolation to fit the output size.

---

**Note** `augmentedImageDatastore` uses the bilinear interpolation method of `imresize` with antialiasing. Bilinear interpolation enables fast image processing while avoiding distortions such as caused by nearest-neighbor interpolation. In contrast, by default `imresize` uses bicubic interpolation with antialiasing to produce a high-quality resized image at the cost of longer processing time.

---

- `'centercrop'` — Take a crop from the center of the training image. The crop has the same size as the output size.
- `'randcrop'` — Take a random crop from the training image. The random crop has the same size as the output size.

Data Types: `char` | `string`

**Object Functions**

<code>combine</code>	Combine data from multiple datastores
<code>hasdata</code>	Determine if data is available to read
<code>partitionByIndex</code>	Partition <code>augmentedImageDatastore</code> according to indices
<code>preview</code>	Subset of data in datastore
<code>read</code>	Read data from <code>augmentedImageDatastore</code>
<code>readall</code>	Read all data in datastore
<code>readByIndex</code>	Read data specified by index from <code>augmentedImageDatastore</code>
<code>reset</code>	Reset datastore to initial state
<code>shuffle</code>	Shuffle data in <code>augmentedImageDatastore</code>
<code>transform</code>	Transform datastore
<code>isPartitionable</code>	Determine whether datastore is partitionable
<code>isShuffleable</code>	Determine whether datastore is shuffleable

**Examples****Train Network with Augmented Images**

Train a convolutional neural network using augmented image data. Data augmentation helps prevent the network from overfitting and memorizing the exact details of the training images.

Load the sample data, which consists of synthetic images of handwritten digits.

```
[XTrain,YTrain] = digitTrain4DArrayData;
```

`digitTrain4DArrayData` loads the digit training set as 4-D array data. `XTrain` is a 28-by-28-by-1-by-5000 array, where:

- 28 is the height and width of the images.
- 1 is the number of channels.

- 5000 is the number of synthetic images of handwritten digits.

YTrain is a categorical vector containing the labels for each observation.

Set aside 1000 of the images for network validation.

```
idx = randperm(size(XTrain,4),1000);
XValidation = XTrain(:,:,:,idx);
XTrain(:,:,:,idx) = [];
YValidation = YTrain(idx);
YTrain(idx) = [];
```

Create an `imageDataAugmenter` object that specifies preprocessing options for image augmentation, such as resizing, rotation, translation, and reflection. Randomly translate the images up to three pixels horizontally and vertically, and rotate the images with an angle up to 20 degrees.

```
imageAugmenter = imageDataAugmenter( ...
    'RandRotation',[-20,20], ...
    'RandXTranslation',[-3 3], ...
    'RandYTranslation',[-3 3])
```

```
imageAugmenter =
    imageDataAugmenter with properties:
```

```
    FillValue: 0
    RandXReflection: 0
    RandYReflection: 0
    RandRotation: [-20 20]
    RandScale: [1 1]
    RandXScale: [1 1]
    RandYScale: [1 1]
    RandXShear: [0 0]
    RandYShear: [0 0]
    RandXTranslation: [-3 3]
    RandYTranslation: [-3 3]
```

Create an `augmentedImageDatastore` object to use for network training and specify the image output size. During training, the datastore performs image augmentation and resizes the images. The datastore augments the images without saving any images to memory. `trainNetwork` updates the network parameters and then discards the augmented images.

```
imageSize = [28 28 1];
augimds = augmentedImageDatastore(imageSize,XTrain,YTrain,'DataAugmentation',imageAugmenter);
```

Specify the convolutional neural network architecture.

```
layers = [
    imageInputLayer(imageSize)

    convolution2dLayer(3,8,'Padding','same')
    batchNormalizationLayer
    reluLayer

    maxPooling2dLayer(2,'Stride',2)

    convolution2dLayer(3,16,'Padding','same')
    batchNormalizationLayer
```

```
reluLayer
maxPooling2dLayer(2, 'Stride', 2)
convolution2dLayer(3, 32, 'Padding', 'same')
batchNormalizationLayer
reluLayer
fullyConnectedLayer(10)
softmaxLayer
classificationLayer];
```

Specify training options for stochastic gradient descent with momentum.

```
opts = trainingOptions('sgdm', ...
    'MaxEpochs', 15, ...
    'Shuffle', 'every-epoch', ...
    'Plots', 'training-progress', ...
    'Verbose', false, ...
    'ValidationData', {XValidation, YValidation});
```

Train the network. Because the validation images are not augmented, the validation accuracy is higher than the training accuracy.

```
net = trainNetwork(augimds, layers, opts);
```

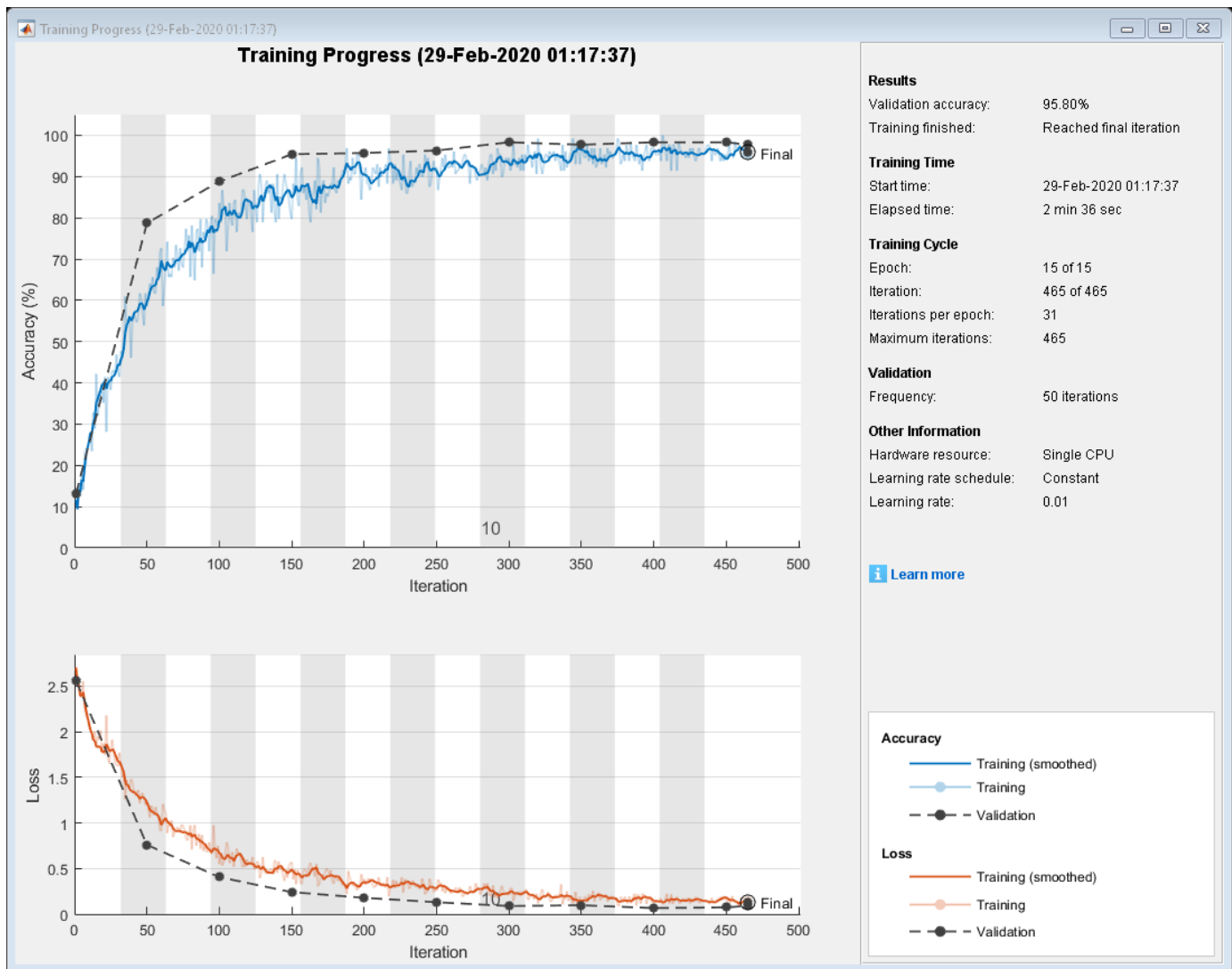

## Tips

- You can visualize many transformed images in the same figure by using the `imtile` function. For example, this code displays one mini-batch of transformed images from an augmented image datastore called `auimds`.

```
minibatch = read(auimds);
imshow(imtile(minibatch.input))
```

- By default, resizing is the only image preprocessing operation performed on images. Enable additional preprocessing operations by using the `DataAugmentation` name-value pair argument with an `imageDataAugmenter` object. Each time images are read from the augmented image datastore, a different random combination of preprocessing operations are applied to each image.

## See Also

`imageDataAugmenter` | `imageInputLayer` | `trainNetwork`

**Topics**

“Deep Learning in MATLAB”

“Preprocess Images for Deep Learning”

**Introduced in R2018a**

## augmentedImageSource

(To be removed) Generate batches of augmented image data

---

**Note** `augmentedImageSource` will be removed in a future release. Create an augmented image datastore using the `augmentedImageDatastore` function instead. For more information, see “Compatibility Considerations”.

---

### Syntax

```
auimds = augmentedImageSource(outputSize,imds)
auimds = augmentedImageSource(outputSize,X,Y)
auimds = augmentedImageSource(outputSize,tbl)
auimds = augmentedImageSource(outputSize,tbl,responseName)
auimds = augmentedImageSource( ___,Name,Value)
```

### Description

`auimds = augmentedImageSource(outputSize,imds)` creates an augmented image datastore, `auimds`, for classification problems using images from image datastore `imds`, with output image size `outputSize`.

`auimds = augmentedImageSource(outputSize,X,Y)` creates an augmented image datastore for classification and regression problems. The array `X` contains the predictor variables and the array `Y` contains the categorical labels or numeric responses.

`auimds = augmentedImageSource(outputSize,tbl)` creates an augmented image datastore for classification and regression problems. The table, `tbl`, contains predictors and responses.

`auimds = augmentedImageSource(outputSize,tbl,responseName)` creates an augmented image datastore for classification and regression problems. The table, `tbl`, contains predictors and responses. The `responseName` argument specifies the response variable in `tbl`.

`auimds = augmentedImageSource( ___,Name,Value)` creates an augmented image datastore, using name-value pairs to configure the image preprocessing done by the augmented image datastore. You can specify multiple name-value pairs.

### Examples

#### Train Network with Rotational Invariance Using `augmentedImageSource`

Preprocess images using random rotation so that the trained convolutional neural network has rotational invariance. This example uses the `augmentedImageSource` function to create an augmented image datastore object. For an example of the recommended workflow that uses the `augmentedImageDatastore` function to create an augmented image datastore object, see “Train Network with Augmented Images” on page 1-87.

Load the sample data, which consists of synthetic images of handwritten numbers.

```
[XTrain,YTrain] = digitTrain4DArrayData;
```

`digitTrain4DArrayData` loads the digit training set as 4-D array data. `XTrain` is a 28-by-28-by-1-by-5000 array, where:

- 28 is the height and width of the images.
- 1 is the number of channels
- 5000 is the number of synthetic images of handwritten digits.

`YTrain` is a categorical vector containing the labels for each observation.

Create an image augmenter that rotates images during training. This image augmenter rotates each image by a random angle.

```
imageAugmenter = imageDataAugmenter('RandRotation',[-180 180])
```

```
imageAugmenter =
  imageDataAugmenter with properties:
```

```
    FillValue: 0
  RandXReflection: 0
  RandYReflection: 0
  RandRotation: [-180 180]
    RandScale: [1 1]
  RandXScale: [1 1]
  RandYScale: [1 1]
  RandXShear: [0 0]
  RandYShear: [0 0]
  RandXTranslation: [0 0]
  RandYTranslation: [0 0]
```

Use the `augmentedImageSource` function to create an augmented image datastore. Specify the size of augmented images, the training data, and the image augmenter.

```
imageSize = [28 28 1];
auimds = augmentedImageSource(imageSize,XTrain,YTrain,'DataAugmentation',imageAugmenter)
```

```
auimds =
  augmentedImageDatastore with properties:
```

```
    NumObservations: 5000
    MiniBatchSize: 128
  DataAugmentation: [1x1 imageDataAugmenter]
  ColorPreprocessing: 'none'
    OutputSize: [28 28]
    OutputSizeMode: 'resize'
  DispatchInBackground: 0
```

Specify the convolutional neural network architecture.

```
layers = [
  imageInputLayer([28 28 1])

  convolution2dLayer(3,16,'Padding',1)
  batchNormalizationLayer
  reluLayer

  maxPooling2dLayer(2,'Stride',2)
```

```

convolution2dLayer(3,32,'Padding',1)
batchNormalizationLayer
reluLayer

maxPooling2dLayer(2,'Stride',2)

convolution2dLayer(3,64,'Padding',1)
batchNormalizationLayer
reluLayer

fullyConnectedLayer(10)
softmaxLayer
classificationLayer];

```

Set the training options for stochastic gradient descent with momentum.

```

opts = trainingOptions('sgdm', ...
    'MaxEpochs',10, ...
    'Shuffle','every-epoch', ...
    'InitialLearnRate',1e-3);

```

Train the network.

```
net = trainNetwork(aumds, layers, opts);
```

Training on single CPU.  
Initializing image normalization.

Epoch	Iteration	Time Elapsed (hh:mm:ss)	Mini-batch Accuracy	Mini-batch Loss	Base Learning Rate
1	1	00:00:01	7.81%	2.4151	0.0010
2	50	00:00:23	52.34%	1.4930	0.0010
3	100	00:00:44	74.22%	1.0148	0.0010
4	150	00:01:05	78.13%	0.8153	0.0010
6	200	00:01:26	76.56%	0.6903	0.0010
7	250	00:01:45	87.50%	0.4891	0.0010
8	300	00:02:06	87.50%	0.4874	0.0010
9	350	00:02:30	87.50%	0.4866	0.0010
10	390	00:02:46	89.06%	0.4021	0.0010

## Input Arguments

### outputSize — Size of output images

vector of two positive integers

Size of output images, specified as a vector of two positive integers. The first element specifies the number of rows in the output images, and the second element specifies the number of columns. This value sets the `OutputSize` on page 1-0 property of the returned augmented image datastore, `aumds`.

### imds — Image datastore

ImageDatastore object

Image datastore, specified as an ImageDatastore object.

ImageDatastore allows batch reading of JPG or PNG image files using prefetching. If you use a custom function for reading the images, then ImageDatastore does not prefetch.



---

**Tip** Use `augmentedImageDatastore` for efficient preprocessing of images for deep learning including image resizing.

Do not use the `readFcn` option of `imageDatastore` as this option is usually significantly slower.

---

### X — Images

4-D numeric array

Images, specified as a 4-D numeric array. The first three dimensions are the height, width, and channels, and the last dimension indexes the individual images.

If the array contains NaNs, then they are propagated through the training. However, in most cases, the training fails to converge.

Data Types: `single` | `double` | `uint8` | `int8` | `uint16` | `int16` | `uint32` | `int32`

### Y — Responses for classification or regression

array of categorical responses | numeric matrix | 4-D numeric array

Responses for classification or regression, specified as one of the following:

- For a classification problem, Y is a categorical vector containing the image labels.
- For a regression problem, Y can be an:
  - $n$ -by- $r$  numeric matrix.  $n$  is the number of observations and  $r$  is the number of responses.
  - $h$ -by- $w$ -by- $c$ -by- $n$  numeric array.  $h$ -by- $w$ -by- $c$  is the size of a single response and  $n$  is the number of observations.

Responses must not contain NaNs.

Data Types: `categorical` | `double`

### tbl — Input data

table

Input data, specified as a table. `tbl` must contain the predictors in the first column as either absolute or relative image paths or images. The type and location of the responses depend on the problem:

- For a classification problem, the response must be a categorical variable containing labels for the images. If the name of the response variable is not specified in the call to `augmentedImageSource`, the responses must be in the second column. If the responses are in a different column of `tbl`, then you must specify the response variable name using the `responseName` positional argument.
- For a regression problem, the responses must be numerical values in the column or columns after the first one. The responses can be either in multiple columns as scalars or in a single column as numeric vectors or cell arrays containing numeric 3-D arrays. When you do not specify the name of the response variable or variables, `augmentedImageSource` accepts the remaining columns of `tbl` as the response variables. You can specify the response variable names using the `responseName` positional argument.

Responses must not contain NaNs. If there are NaNs in the predictor data, they are propagated through the training, however, in most cases the training fails to converge.

Data Types: `table`

**responseName — Names of response variables in the input table**

character vector | cell array of character vectors | string array

Names of the response variables in the input table, specified as a character vector, cell array of character vectors, or a string array. For problems with one response, `responseName` is the corresponding variable name in `tbl`. For regression problems with multiple response variables, `responseName` is an array of the corresponding variable names in `tbl`.

Data Types: `char` | `cell` | `string`**Name-Value Pair Arguments**

Specify optional comma-separated pairs of `Name`, `Value` arguments. `Name` is the argument name and `Value` is the corresponding value. `Name` must appear inside quotes. You can specify several name and value pair arguments in any order as `Name1, Value1, ..., NameN, ValueN`.

Example: `augmentedImageSource([28,28],myTable,'OutputSizeMode','centercrop')` creates an augmented image datastore that sets the `OutputSizeMode` property to crop images from the center.

**ColorPreprocessing — Preprocessing color operations**

'none' (default) | 'gray2rgb' | 'rgb2gray'

Preprocessing operations performed on color channels of input images, specified as the comma-separated pair consisting of 'ColorPreprocessing' and 'none', 'gray2rgb', or 'rgb2gray'. This argument sets the `ColorPreprocessing` on page 1-0 property of the returned augmented image datastore, `auimds`. The `ColorPreprocessing` property ensures that all output images from the augmented image datastore have the number of color channels required by `inputImageLayer`.

**DataAugmentation — Preprocessing applied to input images**'none' (default) | `imageDataAugmenter` object

Preprocessing applied to input images, specified as the comma-separated pair consisting of 'DataAugmentation' and an `imageDataAugmenter` object or 'none'. This argument sets the `DataAugmentation` on page 1-0 property of the returned augmented image datastore, `auimds`. When `DataAugmentation` is 'none', no preprocessing is applied to input images.

**OutputSizeMode — Method used to resize output images**

'resize' (default) | 'centercrop' | 'randcrop'

Method used to resize output images, specified as the comma-separated pair consisting of 'OutputSizeMode' and one of the following. This argument sets the `OutputSizeMode` on page 1-0 property of the returned augmented image datastore, `auimds`.

- 'resize' — Scale the image to fit the output size. For more information, see `imresize`.
- 'centercrop' — Take a crop from the center of the training image. The crop has the same size as the output size.
- 'randcrop' — Take a random crop from the training image. The random crop has the same size as the output size.

Data Types: `char` | `string`**BackgroundExecution — Perform augmentation in parallel**`false` (default) | `true`

Perform augmentation in parallel, specified as the comma-separated pair consisting of 'BackgroundExecution' and false or true. This argument sets the DispatchInBackground on page 1-0 property of the returned augmented image datastore, `auimds`. If 'BackgroundExecution' is true, and you have Parallel Computing Toolbox software installed, then the augmented image datastore `auimds` performs image augmentation in parallel.

## Output Arguments

### **auimds — Augmented image datastore**

`augmentedImageDatastore` object

Augmented image datastore, returned as an `augmentedImageDatastore` object.

## Compatibility Considerations

### **augmentedImageSource object is removed**

In R2017b, you could create an `augmentedImageSource` object to preprocess images for training deep learning networks. Starting in R2018a, the `augmentedImageSource` object has been removed. Use an `augmentedImageDatastore` object instead.

An `augmentedImageDatastore` has additional properties and methods to assist with data preprocessing. Unlike `augmentedImageSource`, which could be used for training only, you can use an `augmentedImageDatastore` for both training and prediction.

To create an `augmentedImageDatastore` object, you can use either the `augmentedImageDatastore` function (recommended) or the `augmentedImageSource` function.

### **augmentedImageSource function will be removed**

*Not recommended starting in R2018a*

The `augmentedImageSource` function will be removed in a future release. Create an `augmentedImageDatastore` using the `augmentedImageDatastore` function instead.

To update your code, change instances of the function name `augmentedImageSource` to `augmentedImageDatastore`. You do not need to change the input arguments.

## See Also

`augmentedImageDatastore`

### **Introduced in R2017b**

# averagePooling2dLayer

Average pooling layer

## Description

An average pooling layer performs down-sampling by dividing the input into rectangular pooling regions and computing the average values of each region.

## Creation

### Syntax

```
layer = averagePooling2dLayer(poolSize)
layer = averagePooling2dLayer(poolSize,Name,Value)
```

### Description

`layer = averagePooling2dLayer(poolSize)` creates an average pooling layer and sets the `PoolSize` property.

`layer = averagePooling2dLayer(poolSize,Name,Value)` sets the optional `Stride` and `Name` properties using name-value pairs. To specify input padding, use the `'Padding'` name-value pair argument. For example, `averagePooling2dLayer(2, 'Stride', 2)` creates an average pooling layer with pool size `[2 2]` and stride `[2 2]`. You can specify multiple name-value pairs. Enclose each property name in single quotes.

### Input Arguments

#### Name-Value Pair Arguments

Use comma-separated name-value pair arguments to specify the size of the zero padding to add along the edges of the layer input or to set the `Stride` and `Name` properties. Enclose names in single quotes.

Example: `averagePooling2dLayer(2, 'Stride', 2)` creates an average pooling layer with pool size `[2 2]` and stride `[2 2]`.

#### Padding — Input edge padding

`[0 0 0 0]` (default) | vector of nonnegative integers | `'same'`

Input edge padding, specified as the comma-separated pair consisting of `'Padding'` and one of these values:

- `'same'` — Add padding of size calculated by the software at training or prediction time so that the output has the same size as the input when the stride equals 1. If the stride is larger than 1, then the output size is `ceil(inputSize/stride)`, where `inputSize` is the height or width of the input and `stride` is the stride in the corresponding dimension. The software adds the same amount of padding to the top and bottom, and to the left and right, if possible. If the padding that must be added vertically has an odd value, then the software adds extra padding to the bottom. If

the padding that must be added horizontally has an odd value, then the software adds extra padding to the right.

- Nonnegative integer `p` — Add padding of size `p` to all the edges of the input.
- Vector `[a b]` of nonnegative integers — Add padding of size `a` to the top and bottom of the input and padding of size `b` to the left and right.
- Vector `[t b l r]` of nonnegative integers — Add padding of size `t` to the top, `b` to the bottom, `l` to the left, and `r` to the right of the input.

Example: 'Padding', 1 adds one row of padding to the top and bottom, and one column of padding to the left and right of the input.

Example: 'Padding', 'same' adds padding so that the output has the same size as the input (if the stride equals 1).

## Properties

### Average Pooling

#### PoolSize — Dimensions of pooling regions

vector of two positive integers

Dimensions of the pooling regions, specified as a vector of two positive integers `[h w]`, where `h` is the height and `w` is the width. When creating the layer, you can specify `PoolSize` as a scalar to use the same value for both dimensions.

If the stride dimensions `Stride` are less than the respective pooling dimensions, then the pooling regions overlap.

The padding dimensions `PaddingSize` must be less than the pooling region dimensions `PoolSize`.

Example: `[2 1]` specifies pooling regions of height 2 and width 1.

#### Stride — Step size for traversing input

`[1 1]` (default) | vector of two positive integers

Step size for traversing the input vertically and horizontally, specified as a vector of two positive integers `[a b]`, where `a` is the vertical step size and `b` is the horizontal step size. When creating the layer, you can specify `Stride` as a scalar to use the same value for both dimensions.

If the stride dimensions `Stride` are less than the respective pooling dimensions, then the pooling regions overlap.

The padding dimensions `PaddingSize` must be less than the pooling region dimensions `PoolSize`.

Example: `[2 3]` specifies a vertical step size of 2 and a horizontal step size of 3.

#### PaddingSize — Size of padding

`[0 0 0 0]` (default) | vector of four nonnegative integers

Size of padding to apply to input borders, specified as a vector `[t b l r]` of four nonnegative integers, where `t` is the padding applied to the top, `b` is the padding applied to the bottom, `l` is the padding applied to the left, and `r` is the padding applied to the right.

When you create a layer, use the 'Padding' name-value pair argument to specify the padding size.

Example: `[1 1 2 2]` adds one row of padding to the top and bottom, and two columns of padding to the left and right of the input.

### **PaddingMode — Method to determine padding size**

`'manual'` (default) | `'same'`

Method to determine padding size, specified as `'manual'` or `'same'`.

The software automatically sets the value of `PaddingMode` based on the `'Padding'` value you specify when creating a layer.

- If you set the `'Padding'` option to a scalar or a vector of nonnegative integers, then the software automatically sets `PaddingMode` to `'manual'`.
- If you set the `'Padding'` option to `'same'`, then the software automatically sets `PaddingMode` to `'same'` and calculates the size of the padding at training time so that the output has the same size as the input when the stride equals 1. If the stride is larger than 1, then the output size is  $\text{ceil}(\text{inputSize}/\text{stride})$ , where `inputSize` is the height or width of the input and `stride` is the stride in the corresponding dimension. The software adds the same amount of padding to the top and bottom, and to the left and right, if possible. If the padding that must be added vertically has an odd value, then the software adds extra padding to the bottom. If the padding that must be added horizontally has an odd value, then the software adds extra padding to the right.

### **Padding — Size of padding**

`[0 0]` (default) | vector of two nonnegative integers

---

**Note** `Padding` property will be removed in a future release. Use `PaddingSize` instead. When creating a layer, use the `'Padding'` name-value pair argument to specify the padding size.

---

Size of padding to apply to input borders vertically and horizontally, specified as a vector `[a b]` of two nonnegative integers, where `a` is the padding applied to the top and bottom of the input data and `b` is the padding applied to the left and right.

Example: `[1 1]` adds one row of padding to the top and bottom, and one column of padding to the left and right of the input.

## **Layer**

### **Name — Layer name**

`''` (default) | character vector | string scalar

Layer name, specified as a character vector or a string scalar. To include a layer in a layer graph, you must specify a nonempty unique layer name. If you train a series network with the layer and `Name` is set to `''`, then the software automatically assigns a name to the layer at training time.

Data Types: `char` | `string`

### **NumInputs — Number of inputs**

1 (default)

Number of inputs of the layer. This layer accepts a single input only.

Data Types: `double`

**InputNames — Input names**

{'in'} (default)

Input names of the layer. This layer accepts a single input only.

Data Types: cell

**NumOutputs — Number of outputs**

1 (default)

Number of outputs of the layer. This layer has a single output only.

Data Types: double

**OutputNames — Output names**

{'out'} (default)

Output names of the layer. This layer has a single output only.

Data Types: cell

**Examples****Create Average Pooling Layer**

Create an average pooling layer with the name 'avg1'.

```
layer = averagePooling2dLayer(2, 'Name', 'avg1')
```

```
layer =
```

```
  AveragePooling2DLayer with properties:
```

```
    Name: 'avg1'
```

```
  Hyperparameters
```

```
    PoolSize: [2 2]
```

```
    Stride: [1 1]
```

```
    PaddingMode: 'manual'
```

```
    PaddingSize: [0 0 0 0]
```

Include an average pooling layer in a Layer array.

```
layers = [ ...
  imageInputLayer([28 28 1])
  convolution2dLayer(5,20)
  reluLayer
  averagePooling2dLayer(2)
  fullyConnectedLayer(10)
  softmaxLayer
  classificationLayer]
```

```
layers =
```

```
  7x1 Layer array with layers:
```

```
  1  ''  Image Input
  2  ''  Convolution
```

```
  28x28x1 images with 'zerocenter' normalization
```

```
  20 5x5 convolutions with stride [1 1] and padding [0 0 0 0]
```

```

3  ''  ReLU                ReLU
4  ''  Average Pooling    2x2 average pooling with stride [1 1] and padding [0 0]
5  ''  Fully Connected    10 fully connected layer
6  ''  Softmax            softmax
7  ''  Classification Output crossentropyex

```

### Create Average Pooling Layer with Nonoverlapping Pooling Regions

Create an average pooling layer with nonoverlapping pooling regions.

```
layer = averagePooling2dLayer(2, 'Stride', 2)
```

```

layer =
  AveragePooling2DLayer with properties:
      Name: ''
      Hyperparameters
        PoolSize: [2 2]
        Stride: [2 2]
        PaddingMode: 'manual'
        PaddingSize: [0 0 0 0]

```

The height and width of the rectangular regions (pool size) are both 2. The pooling regions do not overlap because the step size for traversing the images vertically and horizontally (stride) is also 2.

Include an average pooling layer with nonoverlapping regions in a Layer array.

```

layers = [ ...
  imageInputLayer([28 28 1])
  convolution2dLayer(5,20)
  reluLayer
  averagePooling2dLayer(2, 'Stride', 2)
  fullyConnectedLayer(10)
  softmaxLayer
  classificationLayer]

```

```

layers =
  7x1 Layer array with layers:
      1  ''  Image Input        28x28x1 images with 'zerocenter' normalization
      2  ''  Convolution        20 5x5 convolutions with stride [1 1] and padding [0 0]
      3  ''  ReLU                ReLU
      4  ''  Average Pooling    2x2 average pooling with stride [2 2] and padding [0 0]
      5  ''  Fully Connected    10 fully connected layer
      6  ''  Softmax            softmax
      7  ''  Classification Output crossentropyex

```

### Create Average Pooling Layer with Overlapping Pooling Regions

Create an average pooling layer with overlapping pooling regions.



```
layer = averagePooling2dLayer([3 2], 'Stride', 2)
```

```
layer =
  AveragePooling2DLayer with properties:

    Name: ''

  Hyperparameters
    PoolSize: [3 2]
    Stride: [2 2]
    PaddingMode: 'manual'
    PaddingSize: [0 0 0 0]
```

This layer creates pooling regions of size [3 2] and takes the average of the six elements in each region. The pooling regions overlap because `Stride` includes dimensions that are less than the respective pooling dimensions `PoolSize`.

Include an average pooling layer with overlapping pooling regions in a `Layer` array.

```
layers = [ ...
  imageInputLayer([28 28 1])
  convolution2dLayer(5,20)
  reluLayer
  averagePooling2dLayer([3 2], 'Stride', 2)
  fullyConnectedLayer(10)
  softmaxLayer
  classificationLayer]
```

```
layers =
  7x1 Layer array with layers:
```

1	''	Image Input	28x28x1 images with 'zerocenter' normalization
2	''	Convolution	20 5x5 convolutions with stride [1 1] and padding [0 0 0 0]
3	''	ReLU	ReLU
4	''	Average Pooling	3x2 average pooling with stride [2 2] and padding [0 0 0 0]
5	''	Fully Connected	10 fully connected layer
6	''	Softmax	softmax
7	''	Classification Output	crossentropyex

## More About

### Average Pooling Layer

An average pooling layer performs down-sampling by dividing the input into rectangular pooling regions and computing the average values of each region.

Pooling layers follow the convolutional layers for down-sampling, hence, reducing the number of connections to the following layers. They do not perform any learning themselves, but reduce the number of parameters to be learned in the following layers. They also help reduce overfitting.

An average pooling layer outputs the average values of rectangular regions of its input. The size of the rectangular regions is determined by the `poolSize` argument of `averagePoolingLayer`. For example, if `poolSize` is [2,3], then the layer returns the average value of regions of height 2 and width 3.

Pooling layers scan through the input horizontally and vertically in step sizes you can specify using the 'Stride' name-value pair argument. If the pool size is smaller than or equal to the stride, then the pooling regions do not overlap.

For nonoverlapping regions (*Pool Size* and *Stride* are equal), if the input to the pooling layer is  $n$ -by- $n$ , and the pooling region size is  $h$ -by- $h$ , then the pooling layer down-samples the regions by  $h$  [1]. That is, the output of a max or average pooling layer for one channel of a convolutional layer is  $n/h$ -by- $n/h$ . For overlapping regions, the output of a pooling layer is  $(Input\ Size - Pool\ Size + 2*Padding)/Stride + 1$ .

## References

- [1] Nagi, J., F. Ducatelle, G. A. Di Caro, D. Ciresan, U. Meier, A. Giusti, F. Nagi, J. Schmidhuber, L. M. Gambardella. "Max-Pooling Convolutional Neural Networks for Vision-based Hand Gesture Recognition". *IEEE International Conference on Signal and Image Processing Applications (ICSIPA2011)*, 2011.

## Extended Capabilities

### GPU Code Generation

Generate CUDA® code for NVIDIA® GPUs using GPU Coder™.

### See Also

[convolution2dLayer](#) | [globalAveragePooling2dLayer](#) | [maxPooling2dLayer](#)

### Topics

"Create Simple Deep Learning Network for Classification"

"Train Convolutional Neural Network for Regression"

"Deep Learning in MATLAB"

"Specify Layers of Convolutional Neural Network"

"List of Deep Learning Layers"

### Introduced in R2016a

# averagePooling3dLayer

3-D average pooling layer

## Description

A 3-D average pooling layer performs down-sampling by dividing three-dimensional input into cuboidal pooling regions and computing the average values of each region.

## Creation

### Syntax

```
layer = averagePooling3dLayer(poolSize)
layer = averagePooling3dLayer(poolSize,Name,Value)
```

### Description

`layer = averagePooling3dLayer(poolSize)` creates an average pooling layer and sets the `PoolSize` property.

`layer = averagePooling3dLayer(poolSize,Name,Value)` sets the optional `Stride` and `Name` properties using name-value pairs. To specify input padding, use the `'Padding'` name-value pair argument. For example, `averagePooling3dLayer(2,'Stride',2)` creates a 3-D average pooling layer with pool size `[2 2 2]` and stride `[2 2 2]`. You can specify multiple name-value pairs. Enclose each property name in single quotes.

### Input Arguments

#### Name-Value Pair Arguments

Use comma-separated name-value pair arguments to specify the size of the zero padding to add along the edges of the layer input or to set the `Stride` and `Name` properties. Enclose names in single quotes.

Example: `averagePooling3dLayer(2,'Stride',2)` creates a 3-D average pooling layer with pool size `[2 2 2]` and stride `[2 2 2]`.

#### Padding — Input edge padding

0 (default) | array of nonnegative integers | 'same'

Input edge padding, specified as the comma-separated pair consisting of `'Padding'` and one of these values:

- 'same' — Add padding of size calculated by the software at training or prediction time so that the output has the same size as the input when the stride equals 1. If the stride is larger than 1, then the output size is `ceil(inputSize/stride)`, where `inputSize` is the height, width, or depth of the input and `stride` is the stride in the corresponding dimension. The software adds the same amount of padding to the top and bottom, to the left and right, and to the front and back, if possible. If the padding in a given dimension has an odd value, then the software adds the extra

padding to the input as postpadding. In other words, the software adds extra vertical padding to the bottom, extra horizontal padding to the right, and extra depth padding to the back of the input.

- Nonnegative integer `p` — Add padding of size `p` to all the edges of the input.
- Three-element vector `[a b c]` of nonnegative integers — Add padding of size `a` to the top and bottom, padding of size `b` to the left and right, and padding of size `c` to the front and back of the input.
- 2-by-3 matrix `[t l f; b r k]` of nonnegative integers — Add padding of size `t` to the top, `b` to the bottom, `l` to the left, `r` to the right, `f` to the front, and `k` to the back of the input. In other words, the top row specifies the prepadding and the second row defines the postpadding in the three dimensions.

Example: `'Padding', 1` adds one row of padding to the top and bottom, one column of padding to the left and right, and one plane of padding to the front and back of the input.

Example: `'Padding', 'same'` adds padding so that the output has the same size as the input (if the stride equals 1).

## Properties

### Average Pooling

#### **PoolSize** — Dimensions of pooling regions

vector of three positive integers

Dimensions of the pooling regions, specified as a vector of three positive integers `[h w d]`, where `h` is the height, `w` is the width, and `d` is the depth. When creating the layer, you can specify `PoolSize` as a scalar to use the same value for all three dimensions.

If the stride dimensions `Stride` are less than the respective pooling dimensions, then the pooling regions overlap.

The padding dimensions `PaddingSize` must be less than the pooling region dimensions `PoolSize`.

Example: `[2 1 1]` specifies pooling regions of height 2, width 1, and depth 1.

#### **Stride** — Step size for traversing input

`[1 1 1]` (default) | vector of three positive integers

Step size for traversing the input in three dimensions, specified as a vector `[a b c]` of three positive integers, where `a` is the vertical step size, `b` is the horizontal step size, and `c` is the step size along the depth direction. When creating the layer, you can specify `Stride` as a scalar to use the same value for step sizes in all three directions.

If the stride dimensions `Stride` are less than the respective pooling dimensions, then the pooling regions overlap.

The padding dimensions `PaddingSize` must be less than the pooling region dimensions `PoolSize`.

Example: `[2 3 1]` specifies a vertical step size of 2, a horizontal step size of 3, and a step size along the depth of 1.

#### **PaddingSize** — Size of padding

`[0 0 0; 0 0 0]` (default) | 2-by-3 matrix of nonnegative integers

Size of padding to apply to input borders, specified as 2-by-3 matrix  $[t \ l \ f; b \ r \ k]$  of nonnegative integers, where  $t$  and  $b$  are the padding applied to the top and bottom in the vertical direction,  $l$  and  $r$  are the padding applied to the left and right in the horizontal direction, and  $f$  and  $k$  are the padding applied to the front and back along the depth. In other words, the top row specifies the prepadding and the second row defines the postpadding in the three dimensions.

When you create a layer, use the 'Padding' name-value pair argument to specify the padding size.

Example: `[1 2 4; 1 2 4]` adds one row of padding to the top and bottom, two columns of padding to the left and right, and four planes of padding to the front and back of the input.

### PaddingMode — Method to determine padding size

'manual' (default) | 'same'

Method to determine padding size, specified as 'manual' or 'same'.

The software automatically sets the value of `PaddingMode` based on the 'Padding' value you specify when creating a layer.

- If you set the 'Padding' option to a scalar or a vector of nonnegative integers, then the software automatically sets `PaddingMode` to 'manual'.
- If you set the 'Padding' option to 'same', then the software automatically sets `PaddingMode` to 'same' and calculates the size of the padding at training time so that the output has the same size as the input when the stride equals 1. If the stride is larger than 1, then the output size is  $\text{ceil}(\text{inputSize}/\text{stride})$ , where `inputSize` is the height, width, or depth of the input and `stride` is the stride in the corresponding dimension. The software adds the same amount of padding to the top and bottom, to the left and right, and to the front and back, if possible. If the padding in a given dimension has an odd value, then the software adds the extra padding to the input as postpadding. In other words, the software adds extra vertical padding to the bottom, extra horizontal padding to the right, and extra depth padding to the back of the input.

## Layer

### Name — Layer name

' ' (default) | character vector | string scalar

Layer name, specified as a character vector or a string scalar. To include a layer in a layer graph, you must specify a nonempty unique layer name. If you train a series network with the layer and `Name` is set to ' ', then the software automatically assigns a name to the layer at training time.

Data Types: `char` | `string`

### NumInputs — Number of inputs

1 (default)

Number of inputs of the layer. This layer accepts a single input only.

Data Types: `double`

### InputNames — Input names

{ 'in' } (default)

Input names of the layer. This layer accepts a single input only.

Data Types: `cell`

**NumOutputs — Number of outputs**

1 (default)

Number of outputs of the layer. This layer has a single output only.

Data Types: double

**OutputNames — Output names**

{'out'} (default)

Output names of the layer. This layer has a single output only.

Data Types: cell

**Examples****Create 3-D Average Pooling Layer**

Create a 3-D average pooling layer with nonoverlapping pooling regions that downsamples by a factor of 2.

```
layer = averagePooling3dLayer(2, 'Stride', 2)
```

```
layer =  
AveragePooling3DLayer with properties:
```

```
    Name: ''
```

```
Hyperparameters
```

```
    PoolSize: [2 2 2]
```

```
    Stride: [2 2 2]
```

```
    PaddingMode: 'manual'
```

```
    PaddingSize: [2x3 double]
```

Include a 3-D average pooling layer in a Layer array.

```
layers = [ ...  
    image3dInputLayer([28 28 28 3])  
    convolution3dLayer(5,20)  
    reluLayer  
    averagePooling3dLayer(2, 'Stride', 2)  
    fullyConnectedLayer(10)  
    softmaxLayer  
    classificationLayer]
```

```
layers =  
7x1 Layer array with layers:
```

1	''	3-D Image Input	28x28x28x3 images with 'zerocenter' normalization
2	''	Convolution	20 5x5x5 convolutions with stride [1 1 1] and padding [0
3	''	ReLU	ReLU
4	''	Average 3D Pooling	2x2x2 average pooling with stride [2 2 2] and padding [0
5	''	Fully Connected	10 fully connected layer
6	''	Softmax	softmax
7	''	Classification Output	crossentropyex

## Create 3-D Average Pooling Layer with Overlapping Pooling Regions

Create a 3-D average pooling layer with overlapping pooling regions and padding for the top and bottom of the input.

```
layer = averagePooling3dLayer([3 2 2], 'Stride',2, 'Padding',[1 0 0])
```

```
layer =  
AveragePooling3DLayer with properties:
```

```
    Name: ''
```

```
Hyperparameters
```

```
    PoolSize: [3 2 2]
```

```
    Stride: [2 2 2]
```

```
    PaddingMode: 'manual'
```

```
    PaddingSize: [2x3 double]
```

This layer creates pooling regions of size 3-by-2-by-2 and takes the average of the twelve elements in each region. The stride is 2 in all dimensions. The pooling regions overlap because there are stride dimensions `Stride` that are less than the respective pooling dimensions `PoolSize`.

## More About

### 3-D Average Pooling Layer

A 3-D average pooling layer extends the functionality of an average pooling layer to a third dimension, depth. An average pooling layer performs down-sampling by dividing the input into rectangular or cuboidal pooling regions, and computing the average of each region. To learn more, see the definition of average pooling layer on page 1-103 on the [averagePooling2dLayer](#) reference page.

## See Also

[averagePooling2dLayer](#) | [convolution3dLayer](#) | [maxPooling3dLayer](#)

### Topics

“Deep Learning in MATLAB”

“Specify Layers of Convolutional Neural Network”

“List of Deep Learning Layers”

### Introduced in R2019a

## avgpool

Pool data to average values over spatial dimensions

### Syntax

```
dLY = avgpool(dLX, poolsize)
dLY = avgpool(dLX, poolsize, Name, Value)
dLY = avgpool(dLX, 'global')
dLY = avgpool( ____, 'DataFormat', FMT)
```

### Description

The average pooling operation performs downsampling by dividing the input into pooling regions and computing the average value of each region.

---

**Note** This function applies the average pooling operation to `dLarray` data. If you want to apply average pooling within a `layerGraph` object or `Layer` array, use one of the following layers:

- `averagePooling2dLayer`
  - `averagePooling3dLayer`
  - `globalAveragePooling2dLayer`
  - `globalAveragePooling3dLayer`
- 

`dLY = avgpool(dLX, poolsize)` performs downsampling by dividing the input `dLX` into rectangular or cuboidal regions defined by `poolsize` and computing the average value of the data in each region. The input `dLX` is a formatted `dLarray` with dimension labels. Pooling acts on spatial dimensions labeled 'S'. The output `dLY` is a formatted `dLarray` with the same dimension labels as `dLX`.

`dLY = avgpool(dLX, poolsize, Name, Value)` specifies options using one or more name-value pair arguments. For example, `'Stride', 3` sets the stride of the pooling operation.

`dLY = avgpool(dLX, 'global')` computes the global average over the spatial dimensions of the input `dLX`. This syntax is equivalent to setting `poolsize` in the previous syntax to the size of the 'S' dimensions of `dLX`.

`dLY = avgpool( ____, 'DataFormat', FMT)` specifies the dimension format `FMT` when `dLX` is not a formatted `dLarray`, in addition to the input arguments in previous syntaxes. The output `dLY` is an unformatted `dLarray` with the same dimension order as `dLX`.

### Examples

#### Pool Data to Average Values

Pool data to average values over two spatial dimensions.



Create the input data as a `darray`. The data contains a single observation of random values with a height and width of six and a single channel.

```
height = 6;
width = 6;
channels = 1;
observations = 1;

X = rand(height,width,channels,observations);
d1X = darray(X, 'SSCB')
```

d1X =  
6(S) × 6(S) × 1(C) × 1(B) darray

0.1781	0.8819	0.1564	0.4820	0.2518	0.7302
0.1280	0.6692	0.8555	0.1206	0.2904	0.3439
0.9991	0.1904	0.6448	0.5895	0.6171	0.5841
0.1711	0.3689	0.3763	0.2262	0.2653	0.1078
0.0326	0.4607	0.1909	0.3846	0.8244	0.9063
0.5612	0.9816	0.4283	0.5830	0.9827	0.8797

Pool the data to average values over pooling regions of size 2 using a stride of 2.

```
d1Y = avgpool(d1X,2, 'Stride',2)
```

d1Y =  
3(S) × 3(S) × 1(C) × 1(B) darray

0.4643	0.4036	0.4041
0.4324	0.4592	0.3936
0.5090	0.3967	0.8983

### Pool Data to Global Average Value

Pool data to its global average value.

Create the input data as an unformatted `darray`. The data contains a single observation of random values with a height of four, a width of six, and a single channel.

```
height = 4;
width = 6;
channels = 1;
observations = 1;

X = rand(height,width,channels,observations);
d1X = darray(X)
```

d1X =  
4×6 darray

0.8147	0.6324	0.9575	0.9572	0.4218	0.6557
0.9058	0.0975	0.9649	0.4854	0.9157	0.0357
0.1270	0.2785	0.1576	0.8003	0.7922	0.8491
0.9134	0.5469	0.9706	0.1419	0.9595	0.9340

Pool the data to the global average value. Specify the dimension format of the input data.

```
dLY = avgpool(dlX, 'global', 'DataFormat', 'SSCB')  
  
dLY =  
    1×1 dlarray  
    0.6381
```

## Input Arguments

### **dlX — Input data**

dlarray

Input data, specified as a `dlarray` with or without dimension labels. When `dlX` is not a formatted `dlarray`, you must specify the dimension label format using `'DataFormat', FMT`.

Pooling acts on dimensions that you specify as spatial dimensions using the `'S'` dimension label. `dlX` must have at least one `'S'` dimension. You can specify up to three dimensions in `dlX` as `'S'` dimensions. The `avgpool` operation divides the data along each `'S'` dimension into regions defined by `poolsize`. Values within each pooling region are averaged.

Data Types: `single` | `double`

### **poolsize — Size of pooling regions**

numeric scalar | numeric vector

Size of the pooling regions, specified as a numeric scalar or numeric vector. If you specify `poolsize` as a scalar, the pooling regions have the same size along all spatial dimensions. To use rectangular or cuboidal pooling regions that have different sizes along each spatial dimension, specify `poolsize` as a vector with the same length as the number of spatial dimensions in `dlX`.

Example: 3

Data Types: `single` | `double`

### **Name-Value Pair Arguments**

Specify optional comma-separated pairs of `Name, Value` arguments. `Name` is the argument name and `Value` is the corresponding value. `Name` must appear inside quotes. You can specify several name and value pair arguments in any order as `Name1, Value1, ..., NameN, ValueN`.

Example: `'Stride', 2` specifies the stride of the pooling regions as 2.

### **DataFormat — Dimension order of unformatted data**

char array | string

Dimension order of unformatted input data, specified as the comma-separated pair consisting of `'DataFormat'` and a character array or string `FMT` that provides a label for each dimension of the data. Each character in `FMT` must be one of the following:

- `'S'` — Spatial
- `'C'` — Channel
- `'B'` — Batch (for example, samples and observations)
- `'T'` — Time (for example, sequences)
- `'U'` — Unspecified

You can specify multiple dimensions labeled 'S' or 'U'. You can use the labels 'C', 'B', and 'T' at most once.

You must specify 'DataFormat' when the input data dLX is not a formatted dLarray.

Example: 'DataFormat', 'SSCB'

Data Types: char | string

### Stride — Step size for traversing input data

1 (default) | numeric scalar | numeric vector

Step size for traversing the input data, specified as the comma-separated pair consisting of 'Stride' and a numeric scalar or numeric vector. If you specify 'Stride' as a scalar, the same value is used for all spatial dimensions. If you specify 'Stride' as a vector of the same size as the number of spatial dimensions of the input data, the vector values are used for the corresponding spatial dimensions.

The default value of 'Stride' is 1. If 'Stride' is less than poolsize in any dimension, then the pooling regions overlap.

The Stride parameter is not supported for global pooling using the 'global' option.

Example: 'Stride', 3

Data Types: single | double

### Padding — Padding applied to edges of data

0 (default) | 'same' | numeric scalar | numeric vector | numeric matrix

Padding applied to edges of data, specified as the comma-separated pair consisting of 'Padding' and one of the following:

- 'same' — Padding is set so that the output size is the same as the input size when the stride is 1. More generally, the output size of each spatial dimension is  $\text{ceil}(\text{inputSize}/\text{stride})$ , where  $\text{inputSize}$  is the size of the input along a spatial dimension.
- Numeric scalar — The same padding value is applied to both ends of all spatial dimensions.
- Numeric vector — A different padding value is applied along each spatial dimension. Use a vector of size  $d$ , where  $d$  is the number of spatial dimensions of the input data. The  $i$ th element of the vector specifies the padding applied to the start and the end along the  $i$ th spatial dimension.
- Numeric matrix — A different padding value is applied to the start and end of each spatial dimension. Use a matrix of size 2-by- $d$ , where  $d$  is the number of spatial dimensions of the input data. The element  $(1, d)$  specifies the padding applied to the start of spatial dimension  $d$ . The element  $(2, d)$  specifies the padding applied to the end of spatial dimension  $d$ . For example, in 2-D, the format is [top, left; bottom, right].

The default value of 'Padding' is 0.

The 'Padding' parameter is not supported for global pooling using the 'global' option.

Example: 'Padding', 'same'

Data Types: single | double

## Output Arguments

### **dLY — Pooled data**

`dLarray`

Pooled data, returned as a `dLarray`. The output `dLY` has the same underlying data type as the input `dLX`.

If the input data `dLX` is a formatted `dLarray`, `dLY` has the same dimension labels as `dLX`. If the input data is not a formatted `dLarray`, `dLY` is an unformatted `dLarray` with the same dimension order as the input data.

## More About

### **Average Pooling**

The `avgpool` function pools the input data to average values over the spatial dimensions. For more information, see the definition of “Average Pooling Layer” on page 1-103 on the `averagePooling2dLayer` reference page.

## Extended Capabilities

### **GPU Arrays**

Accelerate code by running on a graphics processing unit (GPU) using Parallel Computing Toolbox™.

Usage notes and limitations:

- When the input argument `dLX` is a `dLarray` with underlying data of type `gpuArray`, this function runs on the GPU.

For more information, see “Run MATLAB Functions on a GPU” (Parallel Computing Toolbox).

## See Also

`dLarray` | `dLconv` | `dLfeval` | `dLgradient` | `maxpool`

### **Topics**

“Define Custom Training Loops, Loss Functions, and Networks”

“Train Network Using Model Function”

**Introduced in R2019b**

# batchnorm

Normalize each channel of input data

## Syntax

```
[dLY,mu,sigmaSq] = batchnorm(dlX,offset,scaleFactor)
dLY = batchnorm(dlX,offset,scaleFactor,mu,sigmaSq)
[dLY,datasetMu,datasetSigmaSq] = batchnorm(dlX,offset,scaleFactor,datasetMu,
datasetSigmaSq)
[ ___ ] = batchnorm( ___ , 'DataFormat' , FMT)
[ ___ ] = batchnorm( ___ , Name, Value)
```

## Description

The batch normalization operation normalizes each input channel across a mini-batch. To speed up training of convolutional neural networks and reduce the sensitivity to network initialization, use batch normalization between convolution and nonlinear operations such as `relu`.

---

**Note** This function applies the batch normalization operation to `dLarray` data. If you want to apply batch normalization within a `LayerGraph` object or `Layer` array, use the following layer:

- `batchNormalizationLayer`
- 

`[dLY,mu,sigmaSq] = batchnorm(dlX,offset,scaleFactor)` normalizes each channel of the input mini-batch `dlX` using the mean and variance statistics computed from each channel and applies a scale factor and offset.

The normalized activation is calculated using the following formula:

$$\hat{x}_i = \frac{x_i - \mu_c}{\sqrt{\sigma_c^2 + \varepsilon}}$$

where  $x_i$  is the input activation,  $\mu_c$  (`mu`) and  $\sigma_c^2$  (`sigmaSq`) are the per-channel mean and variance, respectively, and  $\varepsilon$  is a small constant. `mu` and `sigmaSq` are calculated over all 'S' (spatial), 'B' (batch), 'T' (time), and 'U' (unspecified) dimensions in `dlX` for each channel.

The normalized activation is offset and scaled according to the following formula:

$$y_i = \gamma \hat{x}_i + \beta.$$

The offset  $\beta$  and scale factor  $\gamma$  are specified with the `offset` and `scaleFactor` arguments.

The input `dlX` is a formatted `dLarray` with dimension labels. The output `dLY` is a formatted `dLarray` with the same dimension labels as `dlX`.

`dLY = batchnorm(dlX,offset,scaleFactor,mu,sigmaSq)` normalizes each channel of the input `dlX` using the specified `mu` and `sigmaSq` statistics and applies a scale factor and offset.

`[dLY,datasetMu,datasetSigmaSq] = batchnorm(dlX,offset,scaleFactor,datasetMu,datasetSigmaSq)` normalizes each channel of the input mini-batch `dlX` using the mean and variance statistics computed from each channel and applies a scale factor and offset. The function also updates the data set statistics `datasetMu` and `datasetSigmaSq` using the following formula:

$$s_n = \phi s_x + (1 - \phi) s_{n-1}$$

where  $s_n$  is the statistic computed over several mini-batches,  $s_x$  is the per-channel statistic of the current mini-batch, and  $\phi$  is the decay value for the statistic.

Use this syntax to iteratively update the mean and variance statistics over several mini-batches of data during training. Use the final value of the mean and variance computed over all training mini-batches to normalize data for prediction and classification.

`[ ___ ] = batchnorm( ___ , 'DataFormat' , FMT)` also specifies the dimension format `FMT` when `dlX` is not a formatted `dlarray` in addition to the input arguments in previous syntaxes. The output `dLY` is an unformatted `dlarray` with the same dimension order as `dlX`.

`[ ___ ] = batchnorm( ___ , Name, Value)` specifies options using one or more name-value pair arguments in addition to the input arguments in previous syntaxes. For example, `'MeanDecay' , 3` sets the decay rate of the moving average computation.

## Examples

### Normalize Data and Obtain the Statistics

Use `batchnorm` to normalize each channel of a mini-batch and obtain the per-channel normalization statistics.

Create the input data as a single observation of random values with a height and width of four and three channels.

```
height = 4;
width = 4;
channels = 3;
observations = 1;
```

```
X = rand(height,width,channels,observations);
dlX = dlarray(X, 'SSCB');
```

Create the learnable parameters.

```
offset = zeros(channels,1);
scaleFactor = ones(channels,1);
```

Compute the batch normalization and obtain the statistics of each channel of the batch.

```
[dLY,mu,sigmaSq] = batchnorm(dlX,offset,scaleFactor);
mu
sigmaSq
```

```
mu = 3×1
    0.6095
    0.6063
    0.4619
```

```
sigmaSq = 3×1
    0.1128
    0.0880
    0.0805
```

## Update Mean and Variance Over Multiple Batches of Data

Use the `batchnorm` function to normalize several batches of data and update the statistics of the whole data set after each normalization.

Create three batches of data. The data consists of 10-by-10 random arrays with five channels. Each batch contains 20 observations. The second and third batches are scaled by a multiplicative factor of 1.5 and 2.5, respectively, so the mean of the data set increases with each batch.

```
height = 10;
width = 10;
channels = 5;
observations = 20;

X1 = rand(height,width,channels,observations);
dLX1 = dLarray(X1, 'SSCB');

X2 = 1.5*rand(height,width,channels,observations);
dLX2 = dLarray(X2, 'SSCB');

X3 = 2.5*rand(height,width,channels,observations);
dLX3 = dLarray(X3, 'SSCB');
```

Create the learnable parameters.

```
offset = zeros(channels,1);
scale = ones(channels,1);
```

Normalize the first batch of data, `dLX1`, using `batchnorm`. Obtain the values of the mean and variance of this batch as outputs.

```
[dLY1,mu,sigmaSq] = batchnorm(dLX1,offset,scale);
```

Normalize the second batch of data, `dLX2`. Use `mu` and `sigmaSq` as inputs to obtain the values of the combined mean and variance of the data in batches `dLX1` and `dLX2`.

```
[dLY2,datasetMu,datasetSigmaSq] = batchnorm(dLX2,offset,scale,mu,sigmaSq);
```

Normalize the final batch of data, `dLX3`. Update the data set statistics `datasetMu` and `datasetSigmaSq` to obtain the values of the combined mean and variance of all data in batches `dLX1`, `dLX2`, and `dLX3`.

```
[dLY3,datasetMuFull,datasetSigmaSqFull] = batchnorm(dLX3,offset,scale,datasetMu,datasetSigmaSq);
```

Observe the change in the mean of each channel as each batch is normalized.

```
plot([mu';datasetMu';datasetMuFull'])
legend({'Channel 1','Channel 2','Channel 3','Channel 4','Channel 5'},'Location','southeast')
xticks([1 2 3])
xlabel('Number of Batches')
xlim([0.9 3.1])
```

```
ylabel('Per-Channel Mean')
title('Data Set Mean')
```

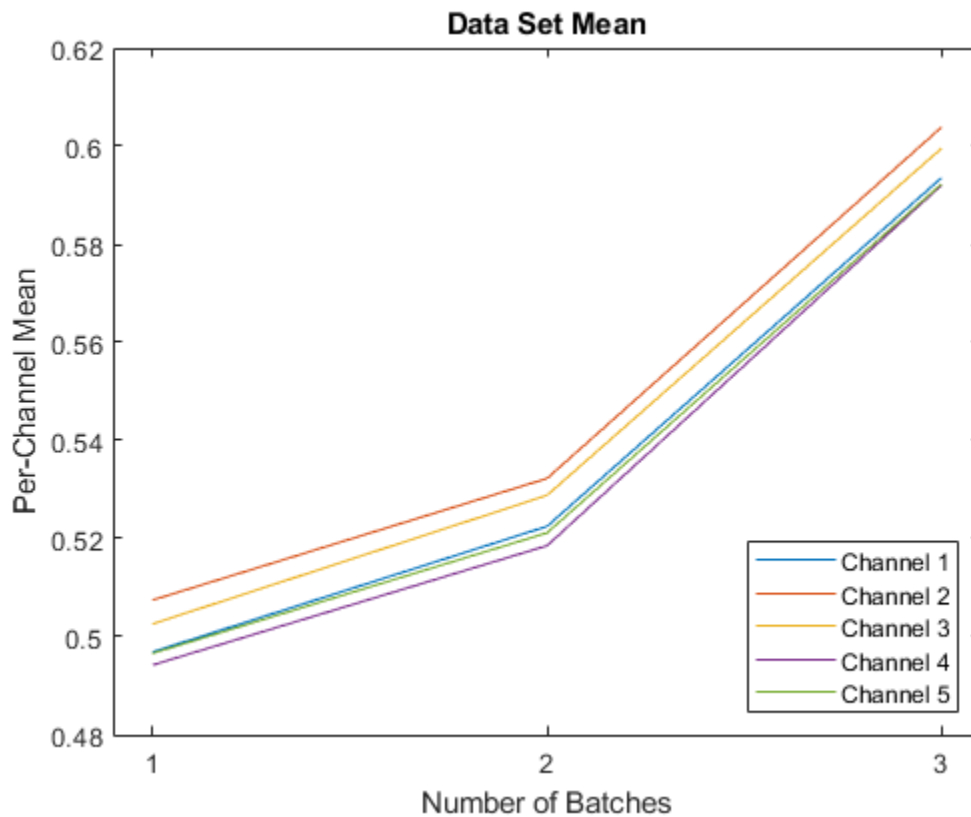

## Input Arguments

### **dIX** — Input data

`dIarray` | numeric array

Input data, specified as a `dIarray` with or without dimension labels or a numeric array. When `dIX` is not a formatted `dIarray`, you must specify the dimension label format using `'DataFormat', FMT`. If `dIX` is a numeric array, at least one of `offset` or `scaleFactor` must be a `dIarray`.

`dIX` must have a `'C'` channel dimension.

Data Types: `single` | `double`

### **offset** — Channel offset

`dIarray` vector | numeric vector

Channel offset  $\beta$ , specified as a `dIarray` vector with or without dimension labels or a numeric vector.

If `offset` is a formatted `dIarray`, it must contain a `'C'` dimension of the same size as the `'C'` dimension of the input data.

Data Types: `single` | `double`



**scaleFactor — Channel scale factor**

dlarray vector | numeric vector

Channel scale factor  $\gamma$ , specified as a dlarray vector with or without dimension labels or a numeric vector.

If `scaleFactor` is a formatted dlarray, it must contain a 'C' dimension of the same size as the 'C' dimension of the input data.

Data Types: single | double

**mu — Mean statistic for normalization**

numeric vector

Mean statistic for normalization, specified as a numeric vector of the same length as the 'C' dimension of the input data.

`mu` is calculated over all 'S' (spatial), 'B' (batch), 'T' (time), and 'U' (unspecified) dimensions in dlX for each channel.

Data Types: single | double

**sigmaSq — Variance statistic for normalization**

numeric vector

Variance statistic for normalization, specified as a numeric vector of the same length as the 'C' dimension of the input data.

`sigmaSq` is calculated over all 'S' (spatial), 'B' (batch), 'T' (time), and 'U' (unspecified) dimensions in dlX for each channel.

Data Types: single | double

**datasetMu — Mean statistic of several batches of data**

numeric vector

Mean statistic of several batches of data, specified as a numeric vector of the same length as the 'C' dimension of the input data. To iteratively update the dataset mean over several batches of input data, use the `datasetMu` output of a previous call to `batchnorm` as the `datasetMu` input argument.

Data Types: single | double

**datasetSigmaSq — Variance statistic of several batches of data**

numeric vector

Variance statistic of several batches of data, specified as a numeric vector of the same length as the 'C' dimension of the input data. To iteratively update the dataset variance over several batches of input data, use the `datasetSigmaSq` output of a previous call to `batchnorm` as the `datasetSigmaSq` input argument.

Data Types: single | double

**Name-Value Pair Arguments**

Specify optional comma-separated pairs of `Name`, `Value` arguments. `Name` is the argument name and `Value` is the corresponding value. `Name` must appear inside quotes. You can specify several name and value pair arguments in any order as `Name1, Value1, ..., NameN, ValueN`.

Example: 'MeanDecay',0.3,'MeanVariance',0.5 sets the decay rate for the moving average computations of the mean and variance of several batches of data to 0.3 and 0.5, respectively.

**DataFormat — Dimension order of unformatted data**

char array | string

Dimension order of unformatted input data, specified as the comma-separated pair consisting of 'DataFormat' and a character array or string FMT that provides a label for each dimension of the data. Each character in FMT must be one of the following:

- 'S' — Spatial
- 'C' — Channel
- 'B' — Batch (for example, samples and observations)
- 'T' — Time (for example, sequences)
- 'U' — Unspecified

You can specify multiple dimensions labeled 'S' or 'U'. You can use the labels 'C', 'B', and 'T' at most once.

You must specify 'DataFormat' when the input data dLX is not a formatted dLarray.

Example: 'DataFormat','SSCB'

Data Types: char | string

**Epsilon — Variance offset**

numeric scalar

Variance offset for preventing divide-by-zero errors, specified as the comma-separated pair consisting of 'Epsilon' and a numeric scalar. The specified value must be greater than 1e-5. The default value is 1e-5.

Data Types: single | double

**MeanDecay — Mean decay value**

numeric scalar between 0 and 1

Decay value for the moving average computation of the datasetMu output, specified as the comma-separated pair consisting of 'MeanDecay' and a numeric scalar between 0 and 1. The default value is 0.1.

Data Types: single | double

**VarianceDecay — Variance decay value**

numeric scalar between 0 and 1

Decay value for the moving average computation of the datasetSigmaSq output, specified as the comma-separated pair consisting of 'VarianceDecay' and a numeric scalar between 0 and 1. The default value is 0.1.

Data Types: single | double

## Output Arguments

### **dLY — Normalized data**

`dlarray`

Normalized data, returned as a `dlarray`. The output `dLY` has the same underlying data type as the input `dLX`.

If the input data `dLX` is a formatted `dlarray`, `dLY` has the same dimension labels as `dLX`. If the input data is not a formatted `dlarray`, `dLY` is an unformatted `dlarray` with the same dimension order as the input data.

### **mu — Per-channel mean**

numeric column vector

Per-channel mean of the input data, returned as a numeric column vector with length equal to the size of the 'C' dimension of the input data.

### **sigmaSq — Per-channel variance**

numeric column vector

Per-channel variance of the input data, returned as a numeric column vector with length equal to the size of the 'C' dimension of the input data.

### **datasetMu — Updated mean statistic of several batches of data**

numeric vector

Updated mean statistic of several batches of data, returned as a numeric vector with length equal to the size of the 'C' dimension of the input data. `datasetMu` is returned with the same shape as the input `datasetMu`.

The `datasetMu` output is the moving average computation of the mean statistic for each channel over several batches of input data. `datasetMu` is computed from the channel mean of the input data and the input `datasetMu` using the following formula:

$$\text{datasetMu} = \text{meanDecay} \times \text{currentMu} + (1 - \text{meanDecay}) \times \text{datasetMu},$$

where `currentMu` is the channel mean computed from the input data and the value of `meanDecay` is specified using the 'MeanDecay' name-value pair argument.

### **datasetSigmaSq — Updated variance statistic of several batches of data**

numeric vector

Updated variance statistic of several batches of data, returned as a numeric vector with length equal to the size of the 'C' dimension of the input data. `datasetSigmaSq` is returned with the same shape as the input `datasetSigmaSq`.

The `datasetSigmaSq` output is the moving average computation of the variance statistic for each channel over several batches of input data. `datasetSigmaSq` is computed from the channel variance of the input data and the input `datasetSigmaSq` using the following formula:

$$\text{datasetSigmaSq} = \text{varianceDecay} \times \text{currentSigmaSq} + (1 - \text{varianceDecay}) \times \text{datasetSigmaSq},$$

where `currentSigmaSq` is the channel variance computed from the input data and the value of `varianceDecay` is specified using the 'VarianceDecay' name-value pair.

## More About

### Batch Normalization

The `batchnorm` function normalizes each input channel of a mini-batch of data. For more information, see the definition of “Batch Normalization Layer” on page 1-128 on the `batchNormalizationLayer` reference page.

## Extended Capabilities

### GPU Arrays

Accelerate code by running on a graphics processing unit (GPU) using Parallel Computing Toolbox™.

Usage notes and limitations:

- When at least one of the following input arguments is a `gpuArray` or a `dlarray` with underlying data of type `gpuArray`, this function runs on the GPU:
  - `dlX`
  - `offset`
  - `scaleFactor`

For more information, see “Run MATLAB Functions on a GPU” (Parallel Computing Toolbox).

## See Also

`dlarray` | `dlconv` | `dlfeval` | `dlgradient` | `fullyconnect` | `relu`

### Topics

“Define Custom Training Loops, Loss Functions, and Networks”

“Update Batch Normalization Statistics Using Model Function”

“Train Network Using Model Function”

“Train Network with Multiple Outputs”

### Introduced in R2019b

# batchNormalizationLayer

Batch normalization layer

## Description

A batch normalization layer normalizes each input channel across a mini-batch. To speed up training of convolutional neural networks and reduce the sensitivity to network initialization, use batch normalization layers between convolutional layers and nonlinearities, such as ReLU layers.

The layer first normalizes the activations of each channel by subtracting the mini-batch mean and dividing by the mini-batch standard deviation. Then, the layer shifts the input by a learnable offset  $\beta$  and scales it by a learnable scale factor  $\gamma$ .

## Creation

### Syntax

```
layer = batchNormalizationLayer  
layer = batchNormalizationLayer('Name',Value)
```

### Description

`layer = batchNormalizationLayer` creates a batch normalization layer.

`layer = batchNormalizationLayer('Name',Value)` creates a batch normalization layer and sets the optional “Batch Normalization” on page 1-123, “Parameters and Initialization” on page 1-124, “Learn Rate and Regularization” on page 1-125, and Name properties using name-value pairs. For example, `batchNormalizationLayer('Name','batchnorm')` creates a batch normalization layer with the name 'batchnorm'. You can specify multiple name-value pairs. Enclose each property name in single quotes.

## Properties

### Batch Normalization

#### TrainedMean — Input mean

numeric array

Input mean of each channel, specified as a numeric array of size 1-by-1-by-NumChannels for 2-D input or 1-by-1-by-1-by-NumChannels for 3-D input.

After network training finishes, the software calculates the input mean over the entire training data set. The layer uses TrainedMean (in place of the mini-batch mean) to normalize the input during prediction.

#### TrainedVariance — Input variance

numeric array

Input variance of each channel, specified as a numeric array of size 1-by-1-by-NumChannels for 2-D input or 1-by-1-by-1-by-NumChannels for 3-D input.

After network training finishes, the software calculates the input variance over the entire training data set. The layer uses `TrainedVariance` (in place of the mini-batch variance) to normalize the input during prediction.

### **Epsilon — Constant to add to mini-batch variances**

1e-5 (default) | numeric scalar

Constant to add to the mini-batch variances, specified as a numeric scalar equal to or larger than 1e-5.

The batch normalization layer adds this constant to the mini-batch variances before normalization to ensure numerical stability and avoid division by zero.

### **NumChannels — Number of input channels**

'auto' (default) | positive integer

Number of input channels, specified as 'auto' or a positive integer.

This property is always equal to the number of channels of the input to the layer. If `NumChannels` equals 'auto', then the software infers the correct value for the number of channels at training time.

## **Parameters and Initialization**

### **ScaleInitializer — Function to initialize channel scale factors**

'ones' (default) | 'zeros' | 'narrow-normal' | function handle

Function to initialize the channel scale factors, specified as one of the following:

- 'ones' - Initialize the channel scale factors with ones.
- 'zeros' - Initialize the channel scale factors with zeros.
- 'narrow-normal' - Initialize the channel scale factors by independently sampling from a normal distribution with zero mean and standard deviation 0.01.
- Function handle - Initialize the channel scale factors with a custom function. If you specify a function handle, then the function must be of the form `scale = func(sz)`, where `sz` is the size of the scale. For an example, see “Specify Custom Weight Initialization Function”.

The layer only initializes the channel scale factors when the `Scale` property is empty.

Data Types: char | string | function\_handle

### **OffsetInitializer — Function to initialize channel offsets**

'zeros' (default) | 'ones' | 'narrow-normal' | function handle

Function to initialize the channel offsets, specified as one of the following:

- 'zeros' - Initialize the channel offsets with zeros.
- 'ones' - Initialize the channel offsets with ones.
- 'narrow-normal' - Initialize the channel offsets by independently sampling from a normal distribution with zero mean and standard deviation 0.01.

- Function handle - Initialize the channel offsets with a custom function. If you specify a function handle, then the function must be of the form `offset = func(sz)`, where `sz` is the size of the scale. For an example, see “Specify Custom Weight Initialization Function”.

The layer only initializes the channel offsets when the `Offset` property is empty.

Data Types: `char` | `string` | `function_handle`

### Scale — Channel scale factors

`[]` (default) | numeric array

Channel scale factors  $\gamma$ , specified as a numeric array.

The channel scale factors are learnable parameters. When training a network, if `Scale` is nonempty, then `trainNetwork` uses the `Scale` property as the initial value. If `Scale` is empty, then `trainNetwork` uses the initializer specified by `ScaleInitializer`.

At training time:

- For 2-D input, `Scale` is a 1-by-1-by-`NumChannels` array of positive numbers.
- For 3-D input, `Scale` is a 1-by-1-by-1-by-`NumChannels` array of positive numbers.

### Offset — Channel offsets

`[]` (default) | numeric array

Channel offsets  $\beta$ , specified as a numeric array.

The channel offsets are learnable parameters. When training a network, if `Offset` is nonempty, then `trainNetwork` uses the `Offset` property as the initial value. If `Offset` is empty, then `trainNetwork` uses the initializer specified by `OffsetInitializer`.

At training time:

- For 2-D input, `Offset` is a 1-by-1-by-`NumChannels` array.
- For 3-D input, `Offset` is a 1-by-1-by-1-by-`NumChannels` array.

## Learn Rate and Regularization

### ScaleLearnRateFactor — Learning rate factor for scale factors

1 (default) | nonnegative scalar

Learning rate factor for the scale factors, specified as a nonnegative scalar.

The software multiplies this factor by the global learning rate to determine the learning rate for the scale factors in a layer. For example, if `ScaleLearnRateFactor` is 2, then the learning rate for the scale factors in the layer is twice the current global learning rate. The software determines the global learning rate based on the settings specified with the `trainingOptions` function.

### OffsetLearnRateFactor — Learning rate factor for offsets

1 (default) | nonnegative scalar

Learning rate factor for the offsets, specified as a nonnegative scalar.

The software multiplies this factor by the global learning rate to determine the learning rate for the offsets in a layer. For example, if `OffsetLearnRateFactor` equals 2, then the learning rate for the

offsets in the layer is twice the current global learning rate. The software determines the global learning rate based on the settings specified with the `trainingOptions` function.

**ScaleL2Factor — L<sub>2</sub> regularization factor for scale factors**

1 (default) | nonnegative scalar

L<sub>2</sub> regularization factor for the scale factors, specified as a nonnegative scalar.

The software multiplies this factor by the global L<sub>2</sub> regularization factor to determine the learning rate for the scale factors in a layer. For example, if `ScaleL2Factor` is 2, then the L<sub>2</sub> regularization for the offsets in the layer is twice the global L<sub>2</sub> regularization factor. You can specify the global L<sub>2</sub> regularization factor using the `trainingOptions` function.

**OffsetL2Factor — L<sub>2</sub> regularization factor for offsets**

1 (default) | nonnegative scalar

L<sub>2</sub> regularization factor for the offsets, specified as a nonnegative scalar.

The software multiplies this factor by the global L<sub>2</sub> regularization factor to determine the learning rate for the offsets in a layer. For example, if `OffsetL2Factor` is 2, then the L<sub>2</sub> regularization for the offsets in the layer is twice the global L<sub>2</sub> regularization factor. You can specify the global L<sub>2</sub> regularization factor using the `trainingOptions` function.

**Layer****Name — Layer name**

' ' (default) | character vector | string scalar

Layer name, specified as a character vector or a string scalar. To include a layer in a layer graph, you must specify a nonempty unique layer name. If you train a series network with the layer and `Name` is set to ' ', then the software automatically assigns a name to the layer at training time.

Data Types: `char` | `string`

**NumInputs — Number of inputs**

1 (default)

Number of inputs of the layer. This layer accepts a single input only.

Data Types: `double`

**InputNames — Input names**

{'in'} (default)

Input names of the layer. This layer accepts a single input only.

Data Types: `cell`

**NumOutputs — Number of outputs**

1 (default)

Number of outputs of the layer. This layer has a single output only.

Data Types: `double`

**OutputNames — Output names**

{'out'} (default)



Output names of the layer. This layer has a single output only.

Data Types: cell

## Examples

### Create Batch Normalization Layer

Create a batch normalization layer with the name 'BN1'.

```
layer = batchNormalizationLayer('Name', 'BN1')
```

```
layer =  
  BatchNormalizationLayer with properties:
```

```
      Name: 'BN1'  
    NumChannels: 'auto'  
   TrainedMean: []  
  TrainedVariance: []
```

```
Hyperparameters  
      Epsilon: 1.0000e-05
```

```
Learnable Parameters  
      Offset: []  
      Scale: []
```

Show all properties

Include batch normalization layers in a Layer array.

```
layers = [  
  imageInputLayer([32 32 3])  
  
  convolution2dLayer(3,16, 'Padding',1)  
  batchNormalizationLayer  
  reluLayer  
  
  maxPooling2dLayer(2, 'Stride',2)  
  
  convolution2dLayer(3,32, 'Padding',1)  
  batchNormalizationLayer  
  reluLayer  
  
  fullyConnectedLayer(10)  
  softmaxLayer  
  classificationLayer  
]
```

```
layers =  
  11x1 Layer array with layers:
```

1	''	Image Input	32x32x3 images with 'zerocenter' normalization
2	''	Convolution	16 3x3 convolutions with stride [1 1] and padding [1 1]
3	''	Batch Normalization	Batch normalization
4	''	ReLU	ReLU

5	''	Max Pooling	2x2 max pooling with stride [2 2] and padding [0 0 0 0]
6	''	Convolution	32 3x3 convolutions with stride [1 1] and padding [1 1]
7	''	Batch Normalization	Batch normalization
8	''	ReLU	ReLU
9	''	Fully Connected	10 fully connected layer
10	''	Softmax	softmax
11	''	Classification Output	crossentropyex

## More About

### Batch Normalization Layer

A batch normalization layer normalizes each input channel across a mini-batch. To speed up training of convolutional neural networks and reduce the sensitivity to network initialization, use batch normalization layers between convolutional layers and nonlinearities, such as ReLU layers.

The layer first normalizes the activations of each channel by subtracting the mini-batch mean and dividing by the mini-batch standard deviation. Then, the layer shifts the input by a learnable offset  $\beta$  and scales it by a learnable scale factor  $\gamma$ .  $\beta$  and  $\gamma$  are themselves learnable parameters that are updated during network training.

Batch normalization layers normalize the activations and gradients propagating through a neural network, making network training an easier optimization problem. To take full advantage of this fact, you can try increasing the learning rate. Since the optimization problem is easier, the parameter updates can be larger and the network can learn faster. You can also try reducing the  $L_2$  and dropout regularization. With batch normalization layers, the activations of a specific image during training depend on which images happen to appear in the same mini-batch. To take full advantage of this regularizing effect, try shuffling the training data before every training epoch. To specify how often to shuffle the data during training, use the 'Shuffle' name-value pair argument of `trainingOptions`.

## Algorithms

A batch normalization normalizes its inputs  $x_i$  by first calculating the mean  $\mu_B$  and variance  $\sigma_B^2$  over a mini-batch and over each input channel. Then, it calculates the normalized activations as

$$\hat{x}_i = \frac{x_i - \mu_B}{\sqrt{\sigma_B^2 + \epsilon}}$$

Here,  $\epsilon$  (the property `Epsilon`) improves numerical stability when the mini-batch variance is very small. To allow for the possibility that inputs with zero mean and unit variance are not optimal for the layer that follows the batch normalization layer, the batch normalization layer further shifts and scales the activations as

$$y_i = \gamma \hat{x}_i + \beta.$$

Here, the offset  $\beta$  and scale factor  $\gamma$  (`Offset` and `Scale` properties) are learnable parameters that are updated during network training.

When network training finishes, the batch normalization layer calculates the mean and variance over the full training set and stores them in the `TrainedMean` and `TrainedVariance` properties. When

you use a trained network to make predictions on new images, the layer uses the trained mean and variance instead of the mini-batch mean and variance to normalize the activations.

## References

[1] Ioffe, Sergey, and Christian Szegedy. "Batch normalization: Accelerating deep network training by reducing internal covariate shift." *preprint, arXiv:1502.03167* (2015).

## Extended Capabilities

### GPU Code Generation

Generate CUDA® code for NVIDIA® GPUs using GPU Coder™.

## See Also

[convolution2dLayer](#) | [fullyConnectedLayer](#) | [reluLayer](#) | [trainNetwork](#) | [trainingOptions](#)

### Topics

["Create Simple Deep Learning Network for Classification"](#)  
["Train Convolutional Neural Network for Regression"](#)  
["Deep Learning in MATLAB"](#)  
["Specify Layers of Convolutional Neural Network"](#)  
["List of Deep Learning Layers"](#)

### Introduced in R2017b

# bilstmLayer

Bidirectional long short-term memory (BiLSTM) layer

## Description

A bidirectional LSTM (BiLSTM) layer learns bidirectional long-term dependencies between time steps of time series or sequence data. These dependencies can be useful when you want the network to learn from the complete time series at each time step.

## Creation

### Syntax

```
layer = bilstmLayer(numHiddenUnits)
layer = bilstmLayer(numHiddenUnits,Name,Value)
```

### Description

`layer = bilstmLayer(numHiddenUnits)` creates a bidirectional LSTM layer and sets the `NumHiddenUnits` property.

`layer = bilstmLayer(numHiddenUnits,Name,Value)` sets additional `OutputMode`, “Activations” on page 1-131, “Parameters and Initialization” on page 1-132, “Learn Rate and Regularization” on page 1-134, and `Name` properties using one or more name-value pair arguments. You can specify multiple name-value pair arguments. Enclose each property name in quotes.

## Properties

### BiLSTM

#### **NumHiddenUnits** — Number of hidden units

positive integer

Number of hidden units (also known as the hidden size), specified as a positive integer.

The number of hidden units corresponds to the amount of information remembered between time steps (the hidden state). The hidden state can contain information from all previous time steps, regardless of the sequence length. If the number of hidden units is too large, then the layer might overfit to the training data. This value can vary from a few dozen to a few thousand.

The hidden state does not limit the number of time steps that are processed in an iteration. To split your sequences into smaller sequences for training, use the `'SequenceLength'` option in `trainingOptions`.

Example: 200

#### **OutputMode** — Format of output

'sequence' (default) | 'last'

Format of output, specified as one of the following:

- 'sequence' - Output the complete sequence.
- 'last' - Output the last time step of the sequence.

### InputSize — Input size

'auto' (default) | positive integer

Input size, specified as a positive integer or 'auto'. If InputSize is 'auto', then the software automatically assigns the input size at training time.

Example: 100

## Activations

### StateActivationFunction — Activation function to update the cell and hidden state

'tanh' (default) | 'softsign'

Activation function to update the cell and hidden state, specified as one of the following:

- 'tanh' - Use the hyperbolic tangent function ( $\tanh$ ).
- 'softsign' - Use the softsign function  $\text{softsign}(x) = \frac{x}{1 + |x|}$ .

The layer uses this option as the function  $\sigma_c$  in the calculations to update the cell and hidden state. For more information on how activation functions are used in an LSTM layer, see “Long Short-Term Memory Layer” on page 1-563.

### GateActivationFunction — Activation function to apply to the gates

'sigmoid' (default) | 'hard-sigmoid'

Activation function to apply to the gates, specified as one of the following:

- 'sigmoid' - Use the sigmoid function  $\sigma(x) = (1 + e^{-x})^{-1}$ .
- 'hard-sigmoid' - Use the hard sigmoid function

$$\sigma(x) = \begin{cases} 0 & \text{if } x < -2.5 \\ 0.2x + 0.5 & \text{if } -2.5 \leq x \leq 2.5 \\ 1 & \text{if } x > 2.5 \end{cases}$$

The layer uses this option as the function  $\sigma_g$  in the calculations for the layer gates.

## State

### CellState — Initial value of cell state

numeric vector

Initial value of the cell state, specified as a  $2 \times \text{NumHiddenUnits}$ -by-1 numeric vector. This value corresponds to the cell state at time step 0.

After setting this property, calls to the `resetState` function set the cell state to this value.

### HiddenState — Initial value of hidden state

numeric vector

Initial value of the hidden state, specified as a  $2 \times \text{NumHiddenUnits}$ -by-1 numeric vector. This value corresponds to the hidden state at time step 0.

After setting this property, calls to the `resetState` function set the hidden state to this value.

### Parameters and Initialization

#### **InputWeightsInitializer — Function to initialize input weights**

'glorot' (default) | 'he' | 'orthogonal' | 'narrow-normal' | 'zeros' | 'ones' | function handle

Function to initialize the input weights, specified as one of the following:

- 'glorot' - Initialize the input weights with the Glorot initializer [1] (also known as Xavier initializer). The Glorot initializer independently samples from a uniform distribution with zero mean and variance  $2/(\text{InputSize} + \text{numOut})$ , where  $\text{numOut} = 8 \times \text{NumHiddenUnits}$ .
- 'he' - Initialize the input weights with the He initializer [2]. The He initializer samples from a normal distribution with zero mean and variance  $2/\text{InputSize}$ .
- 'orthogonal' - Initialize the input weights with  $Q$ , the orthogonal matrix given by the QR decomposition of  $Z = QR$  for a random matrix  $Z$  sampled from a unit normal distribution. [3]
- 'narrow-normal' - Initialize the input weights by independently sampling from a normal distribution with zero mean and standard deviation 0.01.
- 'zeros' - Initialize the input weights with zeros.
- 'ones' - Initialize the input weights with ones.
- Function handle - Initialize the input weights with a custom function. If you specify a function handle, then the function must be of the form `weights = func(sz)`, where `sz` is the size of the input weights.

The layer only initializes the input weights when the `InputWeights` property is empty.

Data Types: char | string | function\_handle

#### **RecurrentWeightsInitializer — Function to initialize recurrent weights**

'orthogonal' (default) | 'glorot' | 'he' | 'narrow-normal' | 'zeros' | 'ones' | function handle

Function to initialize the recurrent weights, specified as one of the following:

- 'orthogonal' - Initialize the input weights with  $Q$ , the orthogonal matrix given by the QR decomposition of  $Z = QR$  for a random matrix  $Z$  sampled from a unit normal distribution. [3]
- 'glorot' - Initialize the recurrent weights with the Glorot initializer [1] (also known as Xavier initializer). The Glorot initializer independently samples from a uniform distribution with zero mean and variance  $2/(\text{numIn} + \text{numOut})$ , where  $\text{numIn} = \text{NumHiddenUnits}$  and  $\text{numOut} = 8 \times \text{NumHiddenUnits}$ .
- 'he' - Initialize the recurrent weights with the He initializer [2]. The He initializer samples from a normal distribution with zero mean and variance  $2/\text{NumHiddenUnits}$ .
- 'narrow-normal' - Initialize the recurrent weights by independently sampling from a normal distribution with zero mean and standard deviation 0.01.
- 'zeros' - Initialize the recurrent weights with zeros.
- 'ones' - Initialize the recurrent weights with ones.

- **Function handle** - Initialize the recurrent weights with a custom function. If you specify a function handle, then the function must be of the form `weights = func(sz)`, where `sz` is the size of the recurrent weights.

The layer only initializes the recurrent weights when the `RecurrentWeights` property is empty.

Data Types: `char` | `string` | `function_handle`

### **BiasInitializer** — Function to initialize bias

'unit-forget-gate' (default) | 'narrow-normal' | 'ones' | function handle

Function to initialize the bias, specified as one of the following:

- 'unit-forget-gate' - Initialize the forget gate bias with ones and the remaining biases with zeros.
- 'narrow-normal' - Initialize the bias by independently sampling from a normal distribution with zero mean and standard deviation 0.01.
- 'ones' - Initialize the bias with ones.
- **Function handle** - Initialize the bias with a custom function. If you specify a function handle, then the function must be of the form `bias = func(sz)`, where `sz` is the size of the bias.

The layer only initializes the bias when the `Bias` property is empty.

Data Types: `char` | `string` | `function_handle`

### **InputWeights** — Input weights

[] (default) | matrix

Input weights, specified as a matrix.

The input weight matrix is a concatenation of the eight input weight matrices for the components (gates) in the bidirectional LSTM layer. The eight matrices are concatenated vertically in the following order:

- 1 Input gate (Forward)
- 2 Forget gate (Forward)
- 3 Cell candidate (Forward)
- 4 Output gate (Forward)
- 5 Input gate (Backward)
- 6 Forget gate (Backward)
- 7 Cell candidate (Backward)
- 8 Output gate (Backward)

The input weights are learnable parameters. When training a network, if `InputWeights` is nonempty, then `trainNetwork` uses the `InputWeights` property as the initial value. If `InputWeights` is empty, then `trainNetwork` uses the initializer specified by `InputWeightsInitializer`.

At training time, `InputWeights` is an  $8 \times \text{NumHiddenUnits}$ -by-`InputSize` matrix.

### **RecurrentWeights** — Recurrent weights

[] (default) | matrix

Recurrent weights, specified as a matrix.

The recurrent weight matrix is a concatenation of the eight recurrent weight matrices for the components (gates) in the bidirectional LSTM layer. The eight matrices are concatenated vertically in the following order:

- 1 Input gate (Forward)
- 2 Forget gate (Forward)
- 3 Cell candidate (Forward)
- 4 Output gate (Forward)
- 5 Input gate (Backward)
- 6 Forget gate (Backward)
- 7 Cell candidate (Backward)
- 8 Output gate (Backward)

The recurrent weights are learnable parameters. When training a network, if `RecurrentWeights` is nonempty, then `trainNetwork` uses the `RecurrentWeights` property as the initial value. If `RecurrentWeights` is empty, then `trainNetwork` uses the initializer specified by `RecurrentWeightsInitializer`.

At training time, `RecurrentWeights` is an  $8 \times \text{NumHiddenUnits}$ -by- $\text{NumHiddenUnits}$  matrix.

### **Bias — Layer biases**

`[]` (default) | numeric vector

Layer biases, specified as a numeric vector.

The bias vector is a concatenation of the eight bias vectors for the components (gates) in the bidirectional LSTM layer. The eight vectors are concatenated vertically in the following order:

- 1 Input gate (Forward)
- 2 Forget gate (Forward)
- 3 Cell candidate (Forward)
- 4 Output gate (Forward)
- 5 Input gate (Backward)
- 6 Forget gate (Backward)
- 7 Cell candidate (Backward)
- 8 Output gate (Backward)

The layer biases are learnable parameters. When training a network, if `Bias` is nonempty, then `trainNetwork` uses the `Bias` property as the initial value. If `Bias` is empty, then `trainNetwork` uses the initializer specified by `BiasInitializer`.

At training time, `Bias` is an  $8 \times \text{NumHiddenUnits}$ -by-1 numeric vector.

### **Learn Rate and Regularization**

#### **InputWeightsLearnRateFactor — Learning rate factor for input weights**

1 (default) | numeric scalar | 1-by-8 numeric vector



Learning rate factor for the input weights, specified as a numeric scalar or a 1-by-8 numeric vector.

The software multiplies this factor by the global learning rate to determine the learning rate factor for the input weights of the layer. For example, if `InputWeightsLearnRateFactor` is 2, then the learning rate factor for the input weights of the layer is twice the current global learning rate. The software determines the global learning rate based on the settings specified with the `trainingOptions` function.

To control the value of the learning rate factor for the four individual matrices in `InputWeights`, assign a 1-by-8 vector, where the entries correspond to the learning rate factor of the following:

- 1 Input gate (Forward)
- 2 Forget gate (Forward)
- 3 Cell candidate (Forward)
- 4 Output gate (Forward)
- 5 Input gate (Backward)
- 6 Forget gate (Backward)
- 7 Cell candidate (Backward)
- 8 Output gate (Backward)

To specify the same value for all the matrices, specify a nonnegative scalar.

Example: `0.1`

### **RecurrentWeightsLearnRateFactor — Learning rate factor for recurrent weights**

1 (default) | numeric scalar | 1-by-8 numeric vector

Learning rate factor for the recurrent weights, specified as a numeric scalar or a 1-by-8 numeric vector.

The software multiplies this factor by the global learning rate to determine the learning rate for the recurrent weights of the layer. For example, if `RecurrentWeightsLearnRateFactor` is 2, then the learning rate for the recurrent weights of the layer is twice the current global learning rate. The software determines the global learning rate based on the settings specified with the `trainingOptions` function.

To control the value of the learn rate for the four individual matrices in `RecurrentWeights`, assign a 1-by-8 vector, where the entries correspond to the learning rate factor of the following:

- 1 Input gate (Forward)
- 2 Forget gate (Forward)
- 3 Cell candidate (Forward)
- 4 Output gate (Forward)
- 5 Input gate (Backward)
- 6 Forget gate (Backward)
- 7 Cell candidate (Backward)
- 8 Output gate (Backward)

To specify the same value for all the matrices, specify a nonnegative scalar.

Example: `0.1`

Example: [1 2 1 1 1 2 1 1]

### **BiasLearnRateFactor — Learning rate factor for biases**

1 (default) | nonnegative scalar | 1-by-8 numeric vector

Learning rate factor for the biases, specified as a nonnegative scalar or a 1-by-8 numeric vector.

The software multiplies this factor by the global learning rate to determine the learning rate for the biases in this layer. For example, if `BiasLearnRateFactor` is 2, then the learning rate for the biases in the layer is twice the current global learning rate. The software determines the global learning rate based on the settings specified with the `trainingOptions` function.

To control the value of the learning rate factor for the four individual matrices in `Bias`, assign a 1-by-8 vector, where the entries correspond to the learning rate factor of the following:

- 1 Input gate (Forward)
- 2 Forget gate (Forward)
- 3 Cell candidate (Forward)
- 4 Output gate (Forward)
- 5 Input gate (Backward)
- 6 Forget gate (Backward)
- 7 Cell candidate (Backward)
- 8 Output gate (Backward)

To specify the same value for all the matrices, specify a nonnegative scalar.

Example: 2

Example: [1 2 1 1 1 2 1 1]

### **InputWeightsL2Factor — L2 regularization factor for input weights**

1 (default) | numeric scalar | 1-by-8 numeric vector

L2 regularization factor for the input weights, specified as a numeric scalar or a 1-by-8 numeric vector.

The software multiplies this factor by the global L2 regularization factor to determine the L2 regularization factor for the input weights of the layer. For example, if `InputWeightsL2Factor` is 2, then the L2 regularization factor for the input weights of the layer is twice the current global L2 regularization factor. The software determines the L2 regularization factor based on the settings specified with the `trainingOptions` function.

To control the value of the L2 regularization factor for the four individual matrices in `InputWeights`, assign a 1-by-8 vector, where the entries correspond to the L2 regularization factor of the following:

- 1 Input gate (Forward)
- 2 Forget gate (Forward)
- 3 Cell candidate (Forward)
- 4 Output gate (Forward)
- 5 Input gate (Backward)
- 6 Forget gate (Backward)

- 7 Cell candidate (Backward)
- 8 Output gate (Backward)

To specify the same value for all the matrices, specify a nonnegative scalar.

Example: 0.1

Example: [1 2 1 1 1 2 1 1]

### **RecurrentWeightsL2Factor — L2 regularization factor for recurrent weights**

1 (default) | numeric scalar | 1-by-8 numeric vector

L2 regularization factor for the recurrent weights, specified as a numeric scalar or a 1-by-8 numeric vector.

The software multiplies this factor by the global L2 regularization factor to determine the L2 regularization factor for the recurrent weights of the layer. For example, if `RecurrentWeightsL2Factor` is 2, then the L2 regularization factor for the recurrent weights of the layer is twice the current global L2 regularization factor. The software determines the L2 regularization factor based on the settings specified with the `trainingOptions` function.

To control the value of the L2 regularization factor for the four individual matrices in `RecurrentWeights`, assign a 1-by-8 vector, where the entries correspond to the L2 regularization factor of the following:

- 1 Input gate (Forward)
- 2 Forget gate (Forward)
- 3 Cell candidate (Forward)
- 4 Output gate (Forward)
- 5 Input gate (Backward)
- 6 Forget gate (Backward)
- 7 Cell candidate (Backward)
- 8 Output gate (Backward)

To specify the same value for all the matrices, specify a nonnegative scalar.

Example: 0.1

Example: [1 2 1 1 1 2 1 1]

### **BiasL2Factor — L2 regularization factor for biases**

0 (default) | nonnegative scalar | 1-by-8 numeric vector

L2 regularization factor for the biases, specified as a nonnegative scalar.

The software multiplies this factor by the global L2 regularization factor to determine the L2 regularization for the biases in this layer. For example, if `BiasL2Factor` is 2, then the L2 regularization for the biases in this layer is twice the global L2 regularization factor. You can specify the global L2 regularization factor using the `trainingOptions` function.

To control the value of the L2 regularization factor for the four individual matrices in `Bias`, assign a 1-by-8 vector, where the entries correspond to the L2 regularization factor of the following:

- 1 Input gate (Forward)
- 2 Forget gate (Forward)
- 3 Cell candidate (Forward)
- 4 Output gate (Forward)
- 5 Input gate (Backward)
- 6 Forget gate (Backward)
- 7 Cell candidate (Backward)
- 8 Output gate (Backward)

To specify the same value for all the matrices, specify a nonnegative scalar.

Example: 2

Example: [1 2 1 1 1 2 1 1]

## Layer

### Name — Layer name

' ' (default) | character vector | string scalar

Layer name, specified as a character vector or a string scalar. If Name is set to ' ', then the software automatically assigns a name at training time.

Data Types: char | string

### NumInputs — Number of inputs

1 (default)

Number of inputs of the layer. This layer accepts a single input only.

Data Types: double

### InputNames — Input names

{'in'} (default)

Input names of the layer. This layer accepts a single input only.

Data Types: cell

### NumOutputs — Number of outputs

1 (default)

Number of outputs of the layer. This layer has a single output only.

Data Types: double

### OutputNames — Output names

{'out'} (default)

Output names of the layer. This layer has a single output only.

Data Types: cell

## Examples

## Create Bidirectional LSTM Layer

Create a bidirectional LSTM layer with the name 'bilstm1' and 100 hidden units.

```
layer = bilstmLayer(100, 'Name', 'bilstm1')
```

```
layer =
  BiLSTMLayer with properties:
      Name: 'bilstm1'

  Hyperparameters
      InputSize: 'auto'
      NumHiddenUnits: 100
      OutputMode: 'sequence'
      StateActivationFunction: 'tanh'
      GateActivationFunction: 'sigmoid'

  Learnable Parameters
      InputWeights: []
      RecurrentWeights: []
      Bias: []

  State Parameters
      HiddenState: []
      CellState: []

  Show all properties
```

Include a bidirectional LSTM layer in a Layer array.

```
inputSize = 12;
numHiddenUnits = 100;
numClasses = 9;

layers = [ ...
  sequenceInputLayer(inputSize)
  bilstmLayer(numHiddenUnits)
  fullyConnectedLayer(numClasses)
  softmaxLayer
  classificationLayer]

layers =
  5x1 Layer array with layers:

   1  ''  Sequence Input           Sequence input with 12 dimensions
   2  ''  BiLSTM                   BiLSTM with 100 hidden units
   3  ''  Fully Connected          9 fully connected layer
   4  ''  Softmax                   softmax
   5  ''  Classification Output    crossentropyex
```

## Compatibility Considerations

### Default input weights initialization is Glorot

*Behavior changed in R2019a*

Starting in R2019a, the software, by default, initializes the layer input weights of this layer using the Glorot initializer. This behavior helps stabilize training and usually reduces the training time of deep networks.

In previous releases, the software, by default, initializes the layer input weights using the by sampling from a normal distribution with zero mean and variance 0.01. To reproduce this behavior, set the 'InputWeightsInitializer' option of the layer to 'narrow-normal'.

### **Default recurrent weights initialization is orthogonal**

*Behavior changed in R2019a*

Starting in R2019a, the software, by default, initializes the layer recurrent weights of this layer with  $Q$ , the orthogonal matrix given by the QR decomposition of  $Z = QR$  for a random matrix  $Z$  sampled from a unit normal distribution. This behavior helps stabilize training and usually reduces the training time of deep networks.

In previous releases, the software, by default, initializes the layer recurrent weights using the by sampling from a normal distribution with zero mean and variance 0.01. To reproduce this behavior, set the 'RecurrentWeightsInitializer' option of the layer to 'narrow-normal'.

## **References**

- [1] Glorot, Xavier, and Yoshua Bengio. "Understanding the difficulty of training deep feedforward neural networks." In *Proceedings of the thirteenth international conference on artificial intelligence and statistics*, pp. 249-256. 2010.
- [2] He, Kaiming, Xiangyu Zhang, Shaoqing Ren, and Jian Sun. "Delving deep into rectifiers: Surpassing human-level performance on imagenet classification." In *Proceedings of the IEEE international conference on computer vision*, pp. 1026-1034. 2015.
- [3] Saxe, Andrew M., James L. McClelland, and Surya Ganguli. "Exact solutions to the nonlinear dynamics of learning in deep linear neural networks." *arXiv preprint arXiv:1312.6120* (2013).

## **Extended Capabilities**

### **GPU Code Generation**

Generate CUDA® code for NVIDIA® GPUs using GPU Coder™.

Usage notes and limitations:

- For code generation, the StateActivationFunction property must be set to 'tanh'.
- For code generation, the GateActivationFunction property must be set to 'sigmoid'.

## **See Also**

**Deep Network Designer** | classifyAndUpdateState | flattenLayer | gruLayer | lstmLayer | predictAndUpdateState | resetState | sequenceFoldingLayer | sequenceInputLayer | sequenceUnfoldingLayer

### **Topics**

"Sequence Classification Using Deep Learning"  
"Classify Videos Using Deep Learning"  
"Visualize Activations of LSTM Network"

“Long Short-Term Memory Networks”

“Specify Layers of Convolutional Neural Network”

“Set Up Parameters and Train Convolutional Neural Network”

“Compare Layer Weight Initializers”

“Deep Learning in MATLAB”

“List of Deep Learning Layers”

**Introduced in R2018a**

## canUseGPU

Verify supported GPU is available for computation

### Syntax

```
tf = canUseGPU()
```

### Description

`tf = canUseGPU()` returns a logical value indicating if there is a GPU available for computation. The function returns logical `1` (`true`) if there is a supported GPU available, a recent GPU driver is present, and Parallel Computing Toolbox is installed and licensed for use. Otherwise, the function returns logical `0` (`false`).

Using a GPU requires Parallel Computing Toolbox and a CUDA enabled NVIDIA GPU with compute capability 3.0 or higher. For more information on supported GPUs, see “GPU Support by Release” (Parallel Computing Toolbox).

### Examples

#### Check GPU Availability to Solve a System of Linear Equations

Solve a system of linear equations. Perform the calculation using a GPU if one is available; otherwise, use the CPU.

Create the data on the CPU.

```
N = 1000;  
A = rand(N);  
b = rand(N,1);
```

Transfer the matrix A to the GPU, if there is one available

```
tf = canUseGPU()  
  
tf =  
    1  
  
if tf  
    A = gpuArray(A);  
end
```

Solve the system of linear equations.

```
x = A\b;
```

Since A exists on the GPU, the solution is calculated on the GPU.

### See Also

`gpuDevice` | `gpuDeviceCount`



**Topics**

“Specify Training Options in Custom Training Loop”

**Introduced in R2019b**

## checkLayer

Check validity of custom layer

### Syntax

```
checkLayer(layer,validInputSize)
checkLayer(layer,validInputSize,'ObservationDimension',dim)
```

### Description

`checkLayer(layer,validInputSize)` checks the validity of a custom layer using generated data of the sizes in `validInputSize`. For layers with a single input, set `validInputSize` to a typical size of input data to the layer. For layers with multiple inputs, set `validInputSize` to a cell array of typical sizes, where each element corresponds to a layer input.

`checkLayer(layer,validInputSize,'ObservationDimension',dim)` specifies the dimension of the data that corresponds to observations. If you specify this parameter, then the function checks the layer for both a single observation and multiple observations.

### Examples

#### Check Layer Validity

Check the validity of the example custom layer `preluLayer`.

Define a custom PReLU layer. To create this layer, save the file `preluLayer.m` in the current folder.

Create an instance of the layer and check that it is valid using `checkLayer`. Set the valid input size to the typical size of a single observation input to the layer. For a single input, the layer expects observations of size  $h$ -by- $w$ -by- $c$ , where  $h$ ,  $w$ , and  $c$  are the height, width, and number of channels of the previous layer output, respectively.

Specify `validInputSize` as the typical size of an input array.

```
layer = preluLayer(20,'prelu');
validInputSize = [5 5 20];
checkLayer(layer,validInputSize)
```

```
Skipping multi-observation tests. To enable tests with multiple observations, specify the 'ObservationDimension' parameter.
For 2-D image data, set 'ObservationDimension' to 4.
For 3-D image data, set 'ObservationDimension' to 5.
For sequence data, set 'ObservationDimension' to 2.
```

```
Skipping GPU tests. No compatible GPU device found.
```

```
Running nnet.checklayer.TestLayerWithoutBackward
.....
Done nnet.checklayer.TestLayerWithoutBackward
```

---

```
Test Summary:
  9 Passed, 0 Failed, 0 Incomplete, 8 Skipped.
  Time elapsed: 1.0705 seconds.
```

The results show the number of passed, failed, and skipped tests. If you do not specify the 'ObservationsDimension' option, or do not have a GPU, then the function skips the corresponding tests.

### Check Multiple Observations

For multi-observation input, the layer expects an array of observations of size  $h$ -by- $w$ -by- $c$ -by- $N$ , where  $h$ ,  $w$ , and  $c$  are the height, width, and number of channels, respectively, and  $N$  is the number of observations.

To check the layer validity for multiple observations, specify the typical size of an observation and set 'ObservationDimension' to 4.

```
layer = preluLayer(20, 'prelu');
validInputSize = [5 5 20];
checkLayer(layer, validInputSize, 'ObservationDimension', 4)
```

Skipping GPU tests. No compatible GPU device found.

```
Running nnet.checklayer.TestLayerWithoutBackward
.....
Done nnet.checklayer.TestLayerWithoutBackward
```

```
Test Summary:
  13 Passed, 0 Failed, 0 Incomplete, 4 Skipped.
  Time elapsed: 0.43429 seconds.
```

In this case, the function does not detect any issues with the layer.

## Input Arguments

### Layer — Custom layer

`nnet.layer.Layer` object | `nnet.layer.ClassificationLayer` object |  
`nnet.layer.RegressionLayer` object

Custom layer, specified as an `nnet.layer.Layer` object, `nnet.layer.ClassificationLayer` object, or `nnet.layer.RegressionLayer` object. For an example showing how to define your own custom layer, see “Define Custom Deep Learning Layer with Learnable Parameters”.

### validInputSize — Valid input sizes

vector of positive integers | cell array of vectors of positive integers

Valid input sizes of the layer, specified as a vector of positive integers or cell array of vectors of positive integers.

- For layers with a single input, specify `validInputSize` as a vector of integers corresponding to the dimensions of the input data. For example, `[5 5 10]` corresponds to valid input data of size 5-by-5-by-10.
- For layers with multiple inputs, specify `validInputSize` as a cell array of vectors, where each vector corresponds to a layer input and the elements of the vectors correspond to the dimensions

of the corresponding input data. For example, {[24 24 20], [24 24 10]} corresponds to the valid input sizes of two inputs, where 24-by-24-by-20 is a valid input size for the first input and 24-by-24-by-10 is a valid input size for the second input.

For more information, see “Layer Input Sizes” on page 1-146.

For large input sizes, the gradient checks take longer to run. To speed up the tests, specify a smaller valid input size.

Example: [5 5 10]

Example: {[24 24 20], [24 24 10]}

Data Types: single | double | int8 | int16 | int32 | int64 | uint8 | uint16 | uint32 | uint64 | cell

### **dim — Observation dimension**

positive integer

Observation dimension, specified as a positive integer.

The observation dimension specifies which dimension of the layer input data corresponds to observations. For example, if the layer expects input data is of size  $h$ -by- $w$ -by- $c$ -by- $N$ , where  $h$ ,  $w$ , and  $c$  correspond to the height, width, and number of channels of the input data, respectively, and  $N$  corresponds to the number of observations, then the observation dimension is 4. For more information, see “Layer Input Sizes” on page 1-146.

If you specify the observation dimension, then the `checkLayer` function checks that the layer functions are valid using generated data with mini-batches of size 1 and 2. If you do not specify the observation dimension, then the function skips the corresponding tests.

Data Types: single | double | int8 | int16 | int32 | int64 | uint8 | uint16 | uint32 | uint64

## **More About**

### **Layer Input Sizes**

For each layer, the valid input size and the observation dimension depend on the output of the previous layer.

### **Intermediate Layers**

For intermediate layers (layers of type `nnet.layer.Layer`), the valid input size and the observation dimension depend on the type of data input to the layer. For layers with a single input, specify `validInputSize` as a vector of integers corresponding to the dimensions of the input data. For layers with multiple inputs, specify `validInputSize` as a cell array of vectors, where each vector corresponds to a layer input and the elements of the vectors correspond to the dimensions of the corresponding input data. For large input sizes, the gradient checks take longer to run. To speed up the tests, specify a smaller valid input size.

Layer Input	Input Size	Observation Dimension
2-D images	$h$ -by- $w$ -by- $c$ -by- $N$ , where $h$ , $w$ , and $c$ correspond to the height, width, and number of channels of the images respectively, and $N$ is the number of observations.	4
3-D images	$h$ -by- $w$ -by- $d$ -by- $c$ -by- $N$ , where $h$ , $w$ , $d$ , and $c$ correspond to the height, width, depth, and number of channels of the 3-D images respectively, and $N$ is the number of observations.	5
Vector sequences	$c$ -by- $N$ -by- $S$ , where $c$ is the number of features of the sequences, $N$ is the number of observations, and $S$ is the sequence length.	2
2-D image sequences	$h$ -by- $w$ -by- $c$ -by- $N$ -by- $S$ , where $h$ , $w$ , and $c$ correspond to the height, width, and number of channels of the images respectively, $N$ is the number of observations, and $S$ is the sequence length.	4
3-D image sequences	$h$ -by- $w$ -by- $d$ -by- $c$ -by- $N$ -by- $S$ , where $h$ , $w$ , $d$ , and $c$ correspond to the height, width, depth, and number of channels of the 3-D images respectively, $N$ is the number of observations, and $S$ is the sequence length.	5

For example, for 2-D image classification problems, set `validInputSize` to `[h w c]`, where  $h$ ,  $w$ , and  $c$  correspond to the height, width, and number of channels of the images, respectively, and `'ObservationDimension'` to 4.,

### Output Layers

For output layers (layers of type `nnet.layer.ClassificationLayer` or `nnet.layer.RegressionLayer`), set `validInputSize` to the typical size of a single input observation  $Y$  to the layer.

For classification problems, the valid input size and the observation dimension of  $Y$  depend on the type of problem:

Classification Task	Input Size	Observation Dimension
2-D image classification	1-by-1-by- $K$ -by- $N$ , where $K$ is the number of classes and $N$ is the number of observations.	4

Classification Task	Input Size	Observation Dimension
3-D image classification	1-by-1-by-1-by- $K$ -by- $N$ , where $K$ is the number of classes and $N$ is the number of observations.	5
Sequence-to-label classification	$K$ -by- $N$ , where $K$ is the number of classes and $N$ is the number of observations.	2
Sequence-to-sequence classification	$K$ -by- $N$ -by- $S$ , where $K$ is the number of classes, $N$ is the number of observations, and $S$ is the sequence length.	2

For example, for 2-D image classification problems, set `validInputSize` to `[1 1 K]`, where  $K$  is the number of classes, and `'ObservationDimension'` to 4.

For regression problems, the dimensions of  $Y$  also depend on the type of problem. The following table describes the dimensions of  $Y$ .

Regression Task	Input Size	Observation Dimension
2-D image regression	1-by-1-by- $R$ -by- $N$ , where $R$ is the number of responses and $N$ is the number of observations.	4
2-D Image-to-image regression	$h$ -by- $w$ -by- $c$ -by- $N$ , where $h$ , $w$ , and $c$ are the height, width, and number of channels of the output respectively, and $N$ is the number of observations.	4
3-D image regression	1-by-1-by-1-by- $R$ -by- $N$ , where $R$ is the number of responses and $N$ is the number of observations.	5
3-D Image-to-image regression	$h$ -by- $w$ -by- $d$ -by- $c$ -by- $N$ , where $h$ , $w$ , $d$ , and $c$ are the height, width, depth, and number of channels of the output respectively, and $N$ is the number of observations.	5
Sequence-to-one regression	$R$ -by- $N$ , where $R$ is the number of responses and $N$ is the number of observations.	2
Sequence-to-sequence regression	$R$ -by- $N$ -by- $S$ , where $R$ is the number of responses, $N$ is the number of observations, and $S$ is the sequence length.	2

For example, for 2-D image regression problems, set `validInputSize` to `[1 1 R]`, where  $R$  is the number of responses, and `'ObservationDimension'` to 4.

## Algorithms

### List of Tests

The `checkLayer` function checks the validity of a custom layer by performing a series of tests, described in these tables. For more information on the tests used by `checkLayer`, see “Check Custom Layer Validity”.

#### Intermediate Layers

The `checkLayer` function uses these tests to check the validity of custom intermediate layers (layers of type `nnet.layer.Layer`).

Test	Description
<code>functionSyntaxesAreCorrect</code>	The syntaxes of the layer functions are correctly defined.
<code>predictDoesNotError</code>	<code>predict</code> does not error.
<code>forwardDoesNotError</code>	When specified, <code>forward</code> does not error.
<code>forwardPredictAreConsistentInSize</code>	When <code>forward</code> is specified, <code>forward</code> and <code>predict</code> output values of the same size.
<code>backwardDoesNotError</code>	When specified, <code>backward</code> does not error.
<code>backwardIsConsistentInSize</code>	When <code>backward</code> is specified, the outputs of <code>backward</code> are consistent in size: <ul style="list-style-type: none"> <li>• The derivatives with respect to each input are the same size as the corresponding input.</li> <li>• The derivatives with respect to each learnable parameter are the same size as the corresponding learnable parameter.</li> </ul>
<code>predictIsConsistentInType</code>	The outputs of <code>predict</code> are consistent in type with the inputs.
<code>forwardIsConsistentInType</code>	When <code>forward</code> is specified, the outputs of <code>forward</code> are consistent in type with the inputs.
<code>backwardIsConsistentInType</code>	When <code>backward</code> is specified, the outputs of <code>backward</code> are consistent in type with the inputs.
<code>gradientsAreNumericallyCorrect</code>	When <code>backward</code> is specified, the gradients computed in <code>backward</code> are consistent with the numerical gradients.
<code>backwardPropagationDoesNotError</code>	When <code>backward</code> is not specified, the derivatives can be computed using automatic differentiation.

The tests `predictIsConsistentInType`, `forwardIsConsistentInType`, and `backwardIsConsistentInType` also check for GPU compatibility. To execute the layer functions on a GPU, the functions must support inputs and outputs of type `gpuArray` with the underlying data type `single`.

#### Output Layers

The `checkLayer` function uses these tests to check the validity of custom output layers (layers of type `nnet.layer.ClassificationLayer` or `nnet.layer.RegressionLayer`).

<b>Test</b>	<b>Description</b>
<code>forwardLossDoesNotError</code>	<code>forwardLoss</code> does not error.
<code>backwardLossDoesNotError</code>	<code>backwardLoss</code> does not error.
<code>forwardLossIsScalar</code>	The output of <code>forwardLoss</code> is scalar.
<code>backwardLossIsConsistentInSize</code>	When <code>backwardLoss</code> is specified, the output of <code>backwardLoss</code> is consistent in size: <code>dLdY</code> is the same size as the predictions <code>Y</code> .
<code>forwardLossIsConsistentInType</code>	The output of <code>forwardLoss</code> is consistent in type: <code>loss</code> is the same type as the predictions <code>Y</code> .
<code>backwardLossIsConsistentInType</code>	When <code>backwardLoss</code> is specified, the output of <code>backwardLoss</code> is consistent in type: <code>dLdY</code> must be the same type as the predictions <code>Y</code> .
<code>gradientsAreNumericallyCorrect</code>	When <code>backwardLoss</code> is specified, the gradients computed in <code>backwardLoss</code> are numerically correct.
<code>backwardPropagationDoesNotError</code>	When <code>backwardLoss</code> is not specified, the derivatives can be computed using automatic differentiation.

The `forwardLossIsConsistentInType` and `backwardLossIsConsistentInType` tests also check for GPU compatibility. To execute the layer functions on a GPU, the functions must support inputs and outputs of type `gpuArray` with the underlying data type `single`.

## See Also

`analyzeNetwork` | `trainNetwork` | `trainingOptions`

## Topics

- “Check Custom Layer Validity”
- “Define Custom Deep Learning Layers”
- “Define Custom Deep Learning Layer with Learnable Parameters”
- “Define Custom Deep Learning Layer with Multiple Inputs”
- “Define Custom Classification Output Layer”
- “Define Custom Weighted Classification Layer”
- “Define Custom Regression Output Layer”
- “List of Deep Learning Layers”
- “Deep Learning Tips and Tricks”

## Introduced in R2018a



# classificationLayer

Classification output layer

## Syntax

```
layer = classificationLayer
layer = classificationLayer(Name,Value)
```

## Description

A classification layer computes the cross entropy loss for multi-class classification problems with mutually exclusive classes.

The layer infers the number of classes from the output size of the previous layer. For example, to specify the number of classes  $K$  of the network, include a fully connected layer with output size  $K$  and a softmax layer before the classification layer.

`layer = classificationLayer` creates a classification layer.

`layer = classificationLayer(Name,Value)` sets the optional `Name` and `Classes` properties using name-value pairs. For example, `classificationLayer('Name','output')` creates a classification layer with the name `'output'`. Enclose each property name in single quotes.

## Examples

### Create Classification Layer

Create a classification layer with the name `'output'`.

```
layer = classificationLayer('Name','output')
```

```
layer =
  ClassificationOutputLayer with properties:
```

```
    Name: 'output'
   Classes: 'auto'
  OutputSize: 'auto'
```

```
Hyperparameters
  LossFunction: 'crossentropyex'
```

Include a classification output layer in a `Layer` array.

```
layers = [ ...
  imageInputLayer([28 28 1])
  convolution2dLayer(5,20)
  reluLayer
  maxPooling2dLayer(2,'Stride',2)
  fullyConnectedLayer(10)
```

```

softmaxLayer
classificationLayer]

layers =
  7x1 Layer array with layers:

   1  ''  Image Input           28x28x1 images with 'zerocenter' normalization
   2  ''  Convolution          20 5x5 convolutions with stride [1 1] and padding [0 0 0 0]
   3  ''  ReLU                 ReLU
   4  ''  Max Pooling          2x2 max pooling with stride [2 2] and padding [0 0 0 0]
   5  ''  Fully Connected      10 fully connected layer
   6  ''  Softmax              softmax
   7  ''  Classification Output crossentropyex

```

## Input Arguments

### Name-Value Pair Arguments

Specify optional comma-separated pairs of `Name`, `Value` arguments. `Name` is the argument name and `Value` is the corresponding value. `Name` must appear inside quotes. You can specify several name and value pair arguments in any order as `Name1, Value1, ..., NameN, ValueN`.

Example: `classificationLayer('Name', 'output')` creates a classification layer with the name 'output'

### Name — Layer name

'' (default) | character vector | string scalar

Layer name, specified as a character vector or a string scalar. To include a layer in a layer graph, you must specify a nonempty unique layer name. If you train a series network with the layer and `Name` is set to '', then the software automatically assigns a name to the layer at training time.

Data Types: `char` | `string`

### Classes — Classes of the output layer

'auto' (default) | categorical vector | string array | cell array of character vectors

Classes of the output layer, specified as a categorical vector, string array, cell array of character vectors, or 'auto'. If `Classes` is 'auto', then the software automatically sets the classes at training time. If you specify the string array or cell array of character vectors `str`, then the software sets the classes of the output layer to `categorical(str, str)`. The default value is 'auto'.

Data Types: `char` | `categorical` | `string` | `cell`

## Output Arguments

### layer — Classification layer

`ClassificationOutputLayer` object

Classification layer, returned as a `ClassificationOutputLayer` object.

For information on concatenating layers to construct convolutional neural network architecture, see `Layer`.

## More About

### Classification Layer

A classification layer computes the cross entropy loss for multi-class classification problems with mutually exclusive classes.

For typical classification networks, the classification layer must follow the softmax layer. In the classification layer, `trainNetwork` takes the values from the softmax function and assigns each input to one of the  $K$  mutually exclusive classes using the cross entropy function for a 1-of- $K$  coding scheme [1]:

$$\text{loss} = - \sum_{i=1}^N \sum_{j=1}^K t_{ij} \ln y_{ij},$$

where  $N$  is the number of samples,  $K$  is the number of classes,  $t_{ij}$  is the indicator that the  $i$ th sample belongs to the  $j$ th class, and  $y_{ij}$  is the output for sample  $i$  for class  $j$ , which in this case, is the value from the softmax function. That is, it is the probability that the network associates the  $i$ th input with class  $j$ .

## References

[1] Bishop, C. M. *Pattern Recognition and Machine Learning*. Springer, New York, NY, 2006.

## Extended Capabilities

### GPU Code Generation

Generate CUDA® code for NVIDIA® GPUs using GPU Coder™.

## See Also

[ClassificationOutputLayer](#) | [regressionLayer](#) | [softmaxLayer](#)

### Topics

“Deep Learning in MATLAB”

“List of Deep Learning Layers”

### Introduced in R2016a

# ClassificationOutputLayer

Classification layer

## Description

A classification layer computes the cross entropy loss for multi-class classification problems with mutually exclusive classes.

## Creation

Create a classification layer using `classificationLayer`.

## Properties

### Classification Output

#### Classes — Classes of the output layer

'auto' (default) | categorical vector | string array | cell array of character vectors

Classes of the output layer, specified as a categorical vector, string array, cell array of character vectors, or 'auto'. If `Classes` is 'auto', then the software automatically sets the classes at training time. If you specify the string array or cell array of character vectors `str`, then the software sets the classes of the output layer to `categorical(str, str)`. The default value is 'auto'.

Data Types: char | categorical | string | cell

#### OutputSize — Size of the output

'auto' (default) | positive integer

This property is read-only.

Size of the output, specified as a positive integer. This value is the number of labels in the data. Before the training, the output size is set to 'auto'.

#### LossFunction — Loss function for training

'crossentropyex'

This property is read-only.

Loss function for training, specified as 'crossentropyex', which stands for *Cross Entropy Function for k Mutually Exclusive Classes*.

### Layer

#### Name — Layer name

' ' (default) | character vector | string scalar

Layer name, specified as a character vector or a string scalar. To include a layer in a layer graph, you must specify a nonempty unique layer name. If you train a series network with the layer and Name is set to '', then the software automatically assigns a name to the layer at training time.

Data Types: char | string

### **NumInputs — Number of inputs**

1 (default)

Number of inputs of the layer. This layer accepts a single input only.

Data Types: double

### **InputNames — Input names**

{'in'} (default)

Input names of the layer. This layer accepts a single input only.

Data Types: cell

### **NumOutputs — Number of outputs**

0 (default)

Number of outputs of the layer. The layer has no outputs.

Data Types: double

### **OutputNames — Output names**

{ } (default)

Output names of the layer. The layer has no outputs.

Data Types: cell

## **Examples**

### **Create Classification Layer**

Create a classification layer with the name 'output'.

```
layer = classificationLayer('Name','output')
```

```
layer =
  ClassificationOutputLayer with properties:
```

```
    Name: 'output'
   Classes: 'auto'
  OutputSize: 'auto'
```

```
Hyperparameters
  LossFunction: 'crossentropyex'
```

Include a classification output layer in a Layer array.

```
layers = [ ...
  imageInputLayer([28 28 1])
  convolution2dLayer(5,20)
```

```

reluLayer
maxPooling2dLayer(2, 'Stride', 2)
fullyConnectedLayer(10)
softmaxLayer
classificationLayer]

layers =
    7x1 Layer array with layers:

    1 '' Image Input          28x28x1 images with 'zerocenter' normalization
    2 '' Convolution         20 5x5 convolutions with stride [1 1] and padding [0 0 0 0]
    3 '' ReLU                ReLU
    4 '' Max Pooling         2x2 max pooling with stride [2 2] and padding [0 0 0 0]
    5 '' Fully Connected    10 fully connected layer
    6 '' Softmax             softmax
    7 '' Classification Output crossentropyex

```

## More About

### Classification Output Layer

A classification layer computes the cross entropy loss for multi-class classification problems with mutually exclusive classes.

For typical classification networks, the classification layer must follow the softmax layer. In the classification layer, `trainNetwork` takes the values from the softmax function and assigns each input to one of the  $K$  mutually exclusive classes using the cross entropy function for a 1-of- $K$  coding scheme [1]:

$$\text{loss} = - \sum_{i=1}^N \sum_{j=1}^K t_{ij} \ln y_{ij},$$

where  $N$  is the number of samples,  $K$  is the number of classes,  $t_{ij}$  is the indicator that the  $i$ th sample belongs to the  $j$ th class, and  $y_{ij}$  is the output for sample  $i$  for class  $j$ , which in this case, is the value from the softmax function. That is, it is the probability that the network associates the  $i$ th input with class  $j$ .

## Compatibility Considerations

### ClassNames property will be removed

*Not recommended starting in R2018b*

`ClassNames` will be removed. Use `Classes` instead. To update your code, replace all instances of `ClassNames` with `Classes`. There are some differences between the properties that require additional updates to your code.

The `ClassNames` property of the output layer is a cell array of character vectors. The `Classes` property is a categorical array. To use the value of `Classes` with functions that require cell array input, convert the classes using the `cellstr` function.

## References

[1] Bishop, C. M. *Pattern Recognition and Machine Learning*. Springer, New York, NY, 2006.

## See Also

`regressionLayer` | `softmaxLayer`

## Topics

[“Create Simple Deep Learning Network for Classification”](#)

[“Train Convolutional Neural Network for Regression”](#)

[“Deep Learning in MATLAB”](#)

[“Specify Layers of Convolutional Neural Network”](#)

[“List of Deep Learning Layers”](#)

## Introduced in R2016a

## classify

Classify data using a trained deep learning neural network

### Syntax

```
[YPred,scores] = classify(net,imds)
[YPred,scores] = classify(net,ds)
[YPred,scores] = classify(net,X)
[YPred,scores] = classify(net,sequences)
[YPred,scores] = classify(net,tbl)
[YPred,scores] = classify( ___,Name,Value)
```

### Description

You can make predictions using a trained neural network for deep learning on either a CPU or GPU. Using a GPU requires Parallel Computing Toolbox and a CUDA enabled NVIDIA GPU with compute capability 3.0 or higher. Specify the hardware requirements using the `ExecutionEnvironment` name-value pair argument.

For networks with multiple outputs, use the `predict` and set the `'ReturnCategorical'` option to `true`.

`[YPred,scores] = classify(net,imds)` predicts class labels for the image data in `imds` using the trained network, `net`.

`[YPred,scores] = classify(net,ds)` predicts class labels for the data in `ds` using the trained network, `net`. For networks with multiple inputs, use this syntax with a combined or transformed datastore object.

`[YPred,scores] = classify(net,X)` predicts class labels for the image data in `X` using the trained network, `net`.

`[YPred,scores] = classify(net,sequences)` predicts class labels for the time series or sequence data in `sequences` using the trained LSTM network, `net`.

`[YPred,scores] = classify(net,tbl)` predicts class labels for the data in `tbl` using the trained network, `net`.

`[YPred,scores] = classify( ___,Name,Value)` predicts class labels with additional options specified by one or more name-value pair arguments.

---

**Tip** When making predictions with sequences of different lengths, the mini-batch size can impact the amount of padding added to the input data which can result in different predicted values. Try using different values to see which works best with your network. To specify mini-batch size and padding options, use the `'MiniBatchSize'` and `'SequenceLength'` options.

---

### Examples



## Classify Images Using Trained ConvNet

Load the sample data.

```
[XTrain,YTrain] = digitTrain4DArrayData;
```

`digitTrain4DArrayData` loads the digit training set as 4-D array data. `XTrain` is a 28-by-28-by-1-by-5000 array, where 28 is the height and 28 is the width of the images. 1 is the number of channels and 5000 is the number of synthetic images of handwritten digits. `YTrain` is a categorical vector containing the labels for each observation.

Construct the convolutional neural network architecture.

```
layers = [ ...
    imageInputLayer([28 28 1])
    convolution2dLayer(5,20)
    reluLayer
    maxPooling2dLayer(2,'Stride',2)
    fullyConnectedLayer(10)
    softmaxLayer
    classificationLayer];
```

Set the options to default settings for the stochastic gradient descent with momentum.

```
options = trainingOptions('sgdm');
```

Train the network.

```
rng('default')
net = trainNetwork(XTrain,YTrain,layers,options);
```

Training on single CPU.  
Initializing input data normalization.

Epoch	Iteration	Time Elapsed (hh:mm:ss)	Mini-batch Accuracy	Mini-batch Loss	Base Learning Rate
1	1	00:00:00	10.16%	2.3195	0.0100
2	50	00:00:06	50.78%	1.7102	0.0100
3	100	00:00:11	63.28%	1.1632	0.0100
4	150	00:00:17	60.16%	1.0859	0.0100
6	200	00:00:23	68.75%	0.8996	0.0100
7	250	00:00:29	76.56%	0.7919	0.0100
8	300	00:00:34	73.44%	0.8411	0.0100
9	350	00:00:40	81.25%	0.5514	0.0100
11	400	00:00:46	90.63%	0.4744	0.0100
12	450	00:00:52	92.19%	0.3614	0.0100
13	500	00:00:56	94.53%	0.3159	0.0100
15	550	00:01:03	96.09%	0.2543	0.0100
16	600	00:01:09	92.19%	0.2765	0.0100
17	650	00:01:14	95.31%	0.2461	0.0100
18	700	00:01:19	99.22%	0.1418	0.0100
20	750	00:01:26	98.44%	0.1000	0.0100
21	800	00:01:32	98.44%	0.1448	0.0100
22	850	00:01:36	98.44%	0.0989	0.0100
24	900	00:01:40	96.88%	0.1316	0.0100
25	950	00:01:46	100.00%	0.0859	0.0100
26	1000	00:01:51	100.00%	0.0701	0.0100

27	1050	00:01:55	100.00%	0.0759	0.0100
29	1100	00:02:00	99.22%	0.0663	0.0100
30	1150	00:02:05	98.44%	0.0775	0.0100
30	1170	00:02:07	99.22%	0.0732	0.0100

Run the trained network on a test set.

```
[XTest,YTest]= digitTest4DArrayData;
YPred = classify(net,XTest);
```

Display the first 10 images in the test data and compare to the classification from `classify`.

```
[YTest(1:10,:) YPred(1:10,:)]
```

```
ans = 10x2 categorical
    0     0
    0     0
    0     0
    0     0
    0     0
    0     0
    0     0
    0     0
    0     0
    0     0
```

The results from `classify` match the true digits for the first ten images.

Calculate the accuracy over all test data.

```
accuracy = sum(YPred == YTest)/numel(YTest)
accuracy = 0.9820
```

### Classify Sequences Using a Trained LSTM Network

Load pretrained network. `JapaneseVowelsNet` is a pretrained LSTM network trained on the Japanese Vowels dataset as described in [1] and [2]. It was trained on the sequences sorted by sequence length with a mini-batch size of 27.

```
load JapaneseVowelsNet
```

View the network architecture.

```
net.Layers
```

```
ans =
    5x1 Layer array with layers:
     1 'sequenceinput' Sequence Input Sequence input with 12 dimensions
     2 'lstm' LSTM LSTM with 100 hidden units
     3 'fc' Fully Connected 9 fully connected layer
     4 'softmax' Softmax softmax
     5 'classoutput' Classification Output crossentropyex with '1' and 8 other classes
```

Load the test data.

```
[XTest,YTest] = japaneseVowelsTestData;
```

Classify the test data.

```
YPred = classify(net,XTest);
```

View the labels of the first 10 sequences with their predicted labels.

```
[YTest(1:10) YPred(1:10)]
```

```
ans = 10x2 categorical
```

```
 1      1
 1      1
 1      1
 1      1
 1      1
 1      1
 1      1
 1      1
 1      1
 1      1
 1      1
```

Calculate the classification accuracy of the predictions.

```
accuracy = sum(YPred == YTest)/numel(YTest)
```

```
accuracy = 0.8595
```

## Input Arguments

### **net** — Trained network

SeriesNetwork object | DAGNetwork object

Trained network, specified as a SeriesNetwork or a DAGNetwork object. You can get a trained network by importing a pretrained network (for example, by using the `googlenet` function) or by training your own network using `trainNetwork`.

### **imds** — Image datastore

ImageDatastore object

Image datastore, specified as an ImageDatastore object.

ImageDatastore allows batch reading of JPG or PNG image files using prefetching. If you use a custom function for reading the images, then ImageDatastore does not prefetch.

---

**Tip** Use `augmentedImageDatastore` for efficient preprocessing of images for deep learning including image resizing.

---

Do not use the `readFcn` option of `imageDatastore` as this option is usually significantly slower.

---

### **ds** — Datastore

datastore

Datastore of input data.

For networks with a single input, `ds` can return either:

- a single image or sequence
- a cell array of images or sequences
- a table, where the first column contains images or sequences

For networks with multiple image inputs layers, `ds` must be a combined or transformed datastore that returns a cell array with `numInputs` columns containing the input data, where `numInputs` is the number of network inputs. The `i`th element of the cell array corresponds to the input `net.InputNames(i)`.

For more information, see “Datastores for Deep Learning”.

### X – Image data

numeric array

Image data, specified as a numeric array. The size of the array depends on the type of image input:

Input	Description
2-D images	A $h$ -by- $w$ -by- $c$ -by- $N$ numeric array, where $h$ , $w$ , and $c$ are the height, width, and number of channels of the images, respectively, and $N$ is the number of images.
3-D images	A $h$ -by- $w$ -by- $d$ -by- $c$ -by- $N$ numeric array, where $h$ , $w$ , $d$ , and $c$ are the height, width, depth, and number of channels of the images, respectively, and $N$ is the number of images.

If the array contains NaNs, then they are propagated through the network.

### sequences – Sequence or time series data

cell array of numeric arrays | numeric array | datastore

Sequence or time series data, specified as an  $N$ -by-1 cell array of numeric arrays, where  $N$  is the number of observations, a numeric array representing a single sequence, or a datastore.

For cell array or numeric array input, the dimensions of the numeric arrays containing the sequences depend on the type of data.

Input	Description
Vector sequences	$c$ -by- $s$ matrices, where $c$ is the number of features of the sequences and $s$ is the sequence length.
2-D image sequences	$h$ -by- $w$ -by- $c$ -by- $s$ arrays, where $h$ , $w$ , and $c$ correspond to the height, width, and number of channels of the images, respectively, and $s$ is the sequence length.
3-D image sequences	$h$ -by- $w$ -by- $d$ -by- $c$ -by- $s$ , where $h$ , $w$ , $d$ , and $c$ correspond to the height, width, depth, and number of channels of the 3-D images, respectively, and $s$ is the sequence length.

For datastore input, the datastore must return data as a cell array of sequences or a table whose first column contains sequences. The dimensions of the sequence data must correspond to the table above.

### **tbl — Table of images**

table

Table of images containing the input data in the first column. Each row in the table corresponds to an observation. The table contains absolute or relative file paths to an image, specified as a character vector or images specified as a numeric array.

Data Types: table

#### **Name-Value Pair Arguments**

Specify optional comma-separated pair of Name, Value argument. Name is the argument name and Value is the corresponding value. Name must appear inside single quotes ( ' ').

Example: 'MiniBatchSize', '256' specifies the mini-batch size as 256.

#### **MiniBatchSize — Size of mini-batches**

128 (default) | positive integer

Size of mini-batches to use for prediction, specified as a positive integer. Larger mini-batch sizes require more memory, but can lead to faster predictions.

When making predictions with sequences of different lengths, the mini-batch size can impact the amount of padding added to the input data which can result in different predicted values. Try using different values to see which works best with your network. To specify mini-batch size and padding options, use the 'MiniBatchSize' and 'SequenceLength' options.

Example: 'MiniBatchSize', 256

#### **Acceleration — Performance optimization**

'auto' (default) | 'mex' | 'none'

Performance optimization, specified as the comma-separated pair consisting of 'Acceleration' and one of the following:

- 'auto' — Automatically apply a number of optimizations suitable for the input network and hardware resource.
- 'mex' — Compile and execute a MEX function. This option is available when using a GPU only. Using a GPU requires Parallel Computing Toolbox and a CUDA enabled NVIDIA GPU with compute capability 3.0 or higher. If Parallel Computing Toolbox or a suitable GPU is not available, then the software returns an error.
- 'none' — Disable all acceleration.

The default option is 'auto'. If 'auto' is specified, MATLAB will apply a number of compatible optimizations. If you use the 'auto' option, MATLAB does not ever generate a MEX function.

Using the 'Acceleration' options 'auto' and 'mex' can offer performance benefits, but at the expense of an increased initial run time. Subsequent calls with compatible parameters are faster. Use performance optimization when you plan to call the function multiple times using new input data.

The `'mex'` option generates and executes a MEX function based on the network and parameters used in the function call. You can have several MEX functions associated with a single network at one time. Clearing the network variable also clears any MEX functions associated with that network.

The `'mex'` option is only available when you are using a GPU. You must have a C/C++ compiler installed and the GPU Coder Interface for Deep Learning Libraries support package. Install the support package using the Add-On Explorer in MATLAB. For setup instructions, see “MEX Setup” (GPU Coder). GPU Coder is not required.

The `'mex'` option does not support all layers. For a list of supported layers, see “Supported Layers” (GPU Coder). Recurrent neural networks (RNNs) containing a `sequenceInputLayer` are not supported.

You cannot use MATLAB Compiler to deploy your network when using the `'mex'` option.

Example: `'Acceleration','mex'`

### **ExecutionEnvironment — Hardware resource**

`'auto'` (default) | `'gpu'` | `'cpu'`

Hardware resource, specified as the comma-separated pair consisting of `'ExecutionEnvironment'` and one of the following:

- `'auto'` — Use a GPU if one is available; otherwise, use the CPU.
- `'gpu'` — Use the GPU. Using a GPU requires Parallel Computing Toolbox and a CUDA enabled NVIDIA GPU with compute capability 3.0 or higher. If Parallel Computing Toolbox or a suitable GPU is not available, then the software returns an error.
- `'cpu'` — Use the CPU.

Example: `'ExecutionEnvironment','cpu'`

### **SequenceLength — Option to pad, truncate, or split input sequences**

`'longest'` (default) | `'shortest'` | positive integer

Option to pad, truncate, or split input sequences, specified as one of the following:

- `'longest'` — Pad sequences in each mini-batch to have the same length as the longest sequence. This option does not discard any data, though padding can introduce noise to the network.
- `'shortest'` — Truncate sequences in each mini-batch to have the same length as the shortest sequence. This option ensures that no padding is added, at the cost of discarding data.
- Positive integer — For each mini-batch, pad the sequences to the nearest multiple of the specified length that is greater than the longest sequence length in the mini-batch, and then split the sequences into smaller sequences of the specified length. If splitting occurs, then the software creates extra mini-batches. Use this option if the full sequences do not fit in memory. Alternatively, try reducing the number of sequences per mini-batch by setting the `'MiniBatchSize'` option to a lower value.

To learn more about the effect of padding, truncating, and splitting the input sequences, see “Sequence Padding, Truncation, and Splitting”.

Example: `'SequenceLength','shortest'`

### **SequencePaddingDirection — Direction of padding or truncation**

`'right'` (default) | `'left'`

Direction of padding or truncation, specified as one of the following:

- 'right' — Pad or truncate sequences on the right. The sequences start at the same time step and the software truncates or adds padding to the end of the sequences.
- 'left' — Pad or truncate sequences on the left. The software truncates or adds padding to the start of the sequences so that the sequences end at the same time step.

Because LSTM layers process sequence data one time step at a time, when the layer `OutputMode` property is 'last', any padding in the final time steps can negatively influence the layer output. To pad or truncate sequence data on the left, set the 'SequencePaddingDirection' option to 'left'.

For sequence-to-sequence networks (when the `OutputMode` property is 'sequence' for each LSTM layer), any padding in the first time steps can negatively influence the predictions for the earlier time steps. To pad or truncate sequence data on the right, set the 'SequencePaddingDirection' option to 'right'.

To learn more about the effect of padding, truncating, and splitting the input sequences, see “Sequence Padding, Truncation, and Splitting”.

### SequencePaddingValue — Value to pad input sequences

0 (default) | scalar

Value by which to pad input sequences, specified as a scalar. The option is valid only when `SequenceLength` is 'longest' or a positive integer. Do not pad sequences with NaN, because doing so can propagate errors throughout the network.

Example: 'SequencePaddingValue', -1

## Output Arguments

### YPred — Predicted class labels

categorical vector | cell array of categorical vectors

Predicted class labels, returned as a categorical vector, or a cell array of categorical vectors. The format of `YPred` depends on the type of problem.

The following table describes the format for classification problems.

Task	Format
Image classification	$N$ -by-1 categorical vector of labels, where $N$ is the number of observations.
Sequence-to-label classification	
Sequence-to-sequence classification	$N$ -by-1 cell array of categorical sequences of labels, where $N$ is the number of observations. Each sequence has the same number of time steps as the corresponding input sequence after applying the <code>SequenceLength</code> option to each mini-batch independently.

For sequence-to-sequence classification problems with one observation, sequences can be a matrix. In this case, `YPred` is a categorical sequence of labels.

**scores — Predicted class scores**

matrix | cell array of matrices

Predicted scores or responses, returned as a matrix or a cell array of matrices. The format of `scores` depends on the type of problem.

The following table describes the format of `scores`.

Task	Format
Image classification	$N$ -by- $K$ matrix, where $N$ is the number of observations, and $K$ is the number of classes
Sequence-to-label classification	
Sequence-to-sequence classification	$N$ -by-1 cell array of matrices, where $N$ is the number of observations. The sequences are matrices with $K$ rows, where $K$ is the number of classes. Each sequence has the same number of time steps as the corresponding input sequence after applying the <code>SequenceLength</code> option to each mini-batch independently.

For sequence-to-sequence classification problems with one observation, `sequences` can be a matrix. In this case, `scores` is a matrix of predicted class scores.

For an example exploring classification scores, see “Classify Webcam Images Using Deep Learning”.

## Algorithms

All functions for deep learning training, prediction, and validation in Deep Learning Toolbox perform computations using single-precision, floating-point arithmetic. Functions for deep learning include `trainNetwork`, `predict`, `classify`, and `activations`. The software uses single-precision arithmetic when you train networks using both CPUs and GPUs.

## Alternatives

For networks with multiple outputs, use the `predict` and set the `'ReturnCategorical'` option to `true`.

You can compute the predicted scores from a trained network using `predict`.

You can also compute the activations from a network layer using `activations`.

For sequence-to-label and sequence-to-sequence classification networks, you can make predictions and update the network state using `classifyAndUpdateState` and `predictAndUpdateState`.

## References

- [1] M. Kudo, J. Toyama, and M. Shimbo. "Multidimensional Curve Classification Using Passing-Through Regions." *Pattern Recognition Letters*. Vol. 20, No. 11-13, pages 1103-1111.
- [2] *UCI Machine Learning Repository: Japanese Vowels Dataset*. <https://archive.ics.uci.edu/ml/datasets/Japanese+Vowels>



## Extended Capabilities

### GPU Code Generation

Generate CUDA® code for NVIDIA® GPUs using GPU Coder™.

Usage notes and limitations:

- GPU code generation supports the following syntaxes:
  - `[YPred,scores] = classify(net,X)`
  - `[YPred,scores] = classify(net,sequences)`
  - `[YPred,scores] = classify(__,Name,Value)`
- GPU code generation for the `classify` function is not supported for regression networks and networks with multiple outputs.
- GPU code generation for the `classify` function supports inputs that are defined as half-precision floating point data types. For more information, see `half`.
- The input `X` must not have variable size. The size must be fixed at code generation time.
- GPU code generation supports only vector sequences. The sequence length can be variable sized. The feature dimension must be fixed at code generation time.
- Only the `'MiniBatchSize'`, `'SequenceLength'`, `'SequencePaddingDirection'`, and `'SequencePaddingValue'` name-value pair arguments are supported for code generation. All name-value pairs must be compile-time constants.
- Only the `'longest'` and `'shortest'` option of the `'SequenceLength'` name-value pair is supported for code generation.

### See Also

`activations` | `classifyAndUpdateState` | `predict` | `predictAndUpdateState`

### Topics

“Classify Image Using GoogLeNet”

“Classify Webcam Images Using Deep Learning”

### Introduced in R2016a

## classifyAndUpdateState

Classify data using a trained recurrent neural network and update the network state

### Syntax

```
[updatedNet,YPred] = classifyAndUpdateState(recNet,sequences)
[updatedNet,YPred] = classifyAndUpdateState( ____,Name,Value)
[updatedNet,YPred,scores] = classifyAndUpdateState( ____ )
```

### Description

You can make predictions using a trained deep learning network on either a CPU or GPU. Using a GPU requires Parallel Computing Toolbox and a CUDA enabled NVIDIA GPU with compute capability 3.0 or higher. Specify the hardware requirements using the "ExecutionEnvironment" on page 1-0 name-value pair argument.

`[updatedNet,YPred] = classifyAndUpdateState(recNet,sequences)` classifies the data in sequences using the trained recurrent neural network `recNet` and updates the network state.

This function supports recurrent neural networks only. The input `recNet` must have at least one recurrent layer.

`[updatedNet,YPred] = classifyAndUpdateState( ____,Name,Value)` uses any of the arguments in the previous syntaxes and additional options specified by one or more `Name, Value` pair arguments. For example, `'MiniBatchSize',27` classifies data using mini-batches of size 27

"Classify and Update Network State" on page 1-168

`[updatedNet,YPred,scores] = classifyAndUpdateState( ____ )` uses any of the arguments in the previous syntaxes, returns a matrix of classification scores, and updates the network state.

---

**Tip** When making predictions with sequences of different lengths, the mini-batch size can impact the amount of padding added to the input data which can result in different predicted values. Try using different values to see which works best with your network. To specify mini-batch size and padding options, use the `'MiniBatchSize'` and `'SequenceLength'` options.

---

## Examples

### Classify and Update Network State

Classify data using a recurrent neural network and update the network state.

Load `JapaneseVowelsNet`, a pretrained long short-term memory (LSTM) network trained on the Japanese Vowels data set as described in [1] and [2]. This network was trained on the sequences sorted by sequence length with a mini-batch size of 27.

```
load JapaneseVowelsNet
```

View the network architecture.

```
net.Layers
```

```
ans =
  5x1 Layer array with layers:

    1 'sequenceinput'  Sequence Input           Sequence input with 12 dimensions
    2 'lstm'           LSTM                   LSTM with 100 hidden units
    3 'fc'             Fully Connected       9 fully connected layer
    4 'softmax'        Softmax                softmax
    5 'classoutput'   Classification Output  crossentropyex with '1' and 8 other classes
```

Load the test data.

```
[XTest,YTest] = japaneseVowelsTestData;
```

Loop over the time steps in a sequence. Classify each time step and update the network state.

```
X = XTest{94};
numTimeSteps = size(X,2);
for i = 1:numTimeSteps
    v = X(:,i);
    [net,label,score] = classifyAndUpdateState(net,v);
    labels(i) = label;
end
```

Plot the predicted labels in a stair plot. The plot shows how the predictions change between time steps.

```
figure
stairs(labels, '-o')
xlim([1 numTimeSteps])
xlabel("Time Step")
ylabel("Predicted Class")
title("Classification Over Time Steps")
```

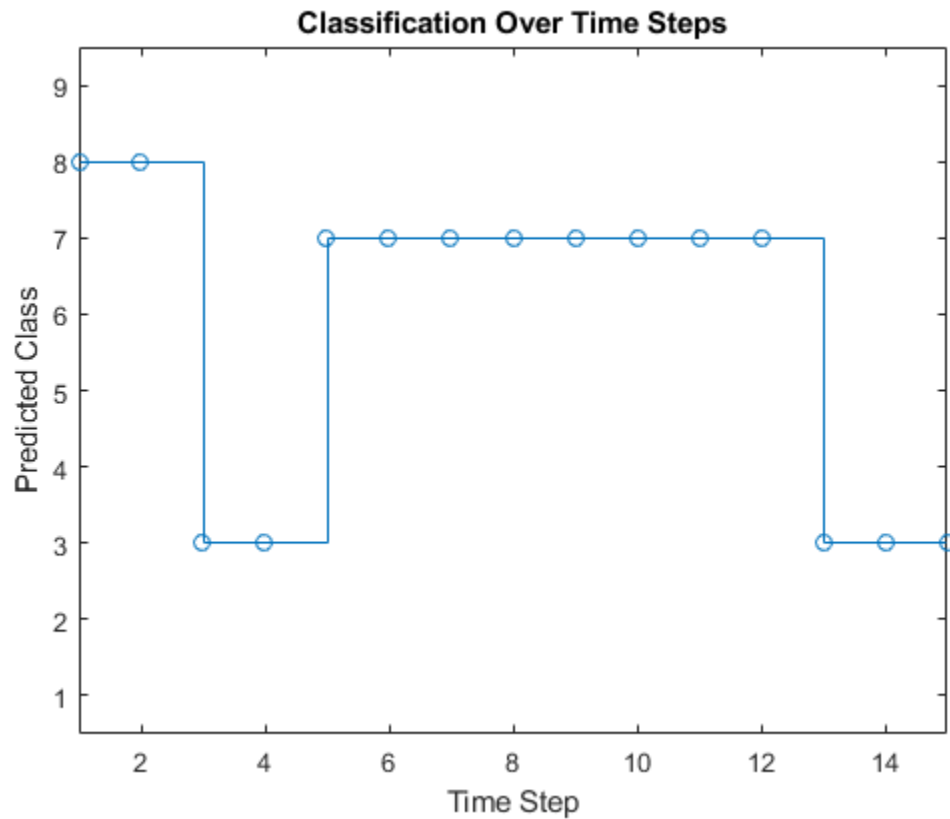

Compare the predictions with the true label. Plot a horizontal line showing the true label of the observation.

```
trueLabel = YTest(94)
```

```
trueLabel = categorical  
3
```

```
hold on  
line([1 numTimeSteps],[trueLabel trueLabel], ...  
      'Color','red', ...  
      'LineStyle','--')  
legend(["Prediction" "True Label"])
```

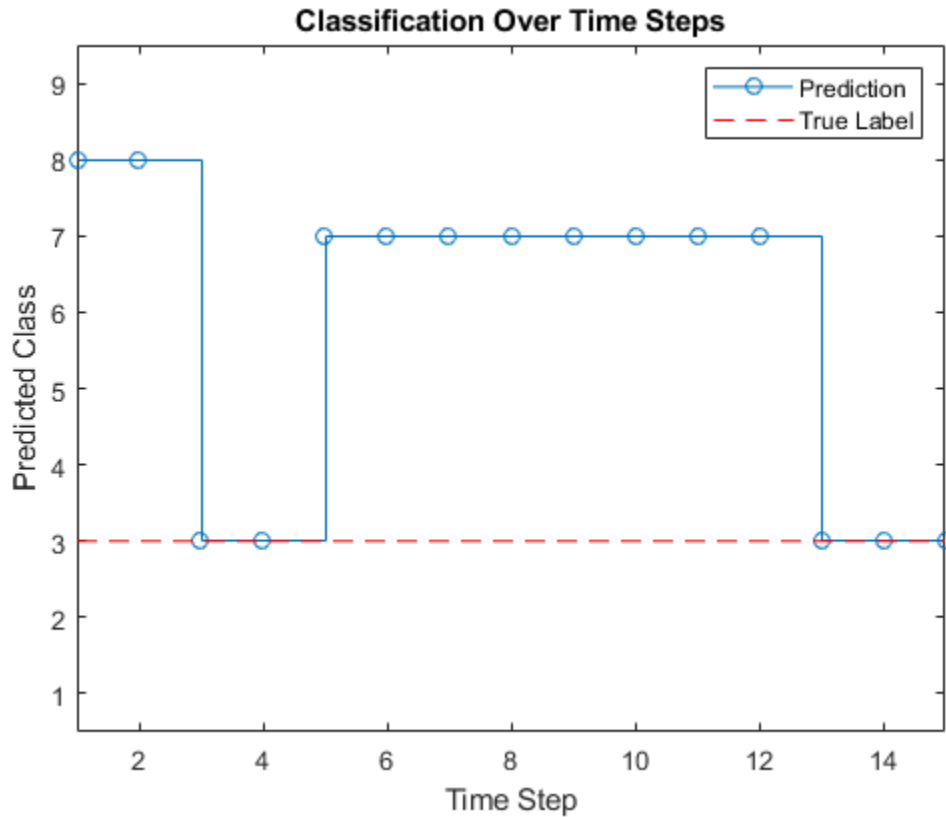

## Input Arguments

### **recNet** — Trained recurrent neural network

SeriesNetwork object | DAGNetwork object

Trained recurrent neural network, specified as a SeriesNetwork or a DAGNetwork object. You can get a trained network by importing a pretrained network or by training your own network using the trainNetwork function.

recNet is a recurrent neural network. It must have at least one recurrent layer (for example, an LSTM network).

### **sequences** — Sequence or time series data

cell array of numeric arrays | numeric array | datastore

Sequence or time series data, specified as an  $N$ -by-1 cell array of numeric arrays, where  $N$  is the number of observations, a numeric array representing a single sequence, or a datastore.

For cell array or numeric array input, the dimensions of the numeric arrays containing the sequences depend on the type of data.

Input	Description
Vector sequences	$c$ -by- $s$ matrices, where $c$ is the number of features of the sequences and $s$ is the sequence length.
2-D image sequences	$h$ -by- $w$ -by- $c$ -by- $s$ arrays, where $h$ , $w$ , and $c$ correspond to the height, width, and number of channels of the images, respectively, and $s$ is the sequence length.
3-D image sequences	$h$ -by- $w$ -by- $d$ -by- $c$ -by- $s$ , where $h$ , $w$ , $d$ , and $c$ correspond to the height, width, depth, and number of channels of the 3-D images, respectively, and $s$ is the sequence length.

For datastore input, the datastore must return data as a cell array of sequences or a table whose first column contains sequences. The dimensions of the sequence data must correspond to the table above.

### Name-Value Pair Arguments

Specify optional comma-separated pairs of `Name`, `Value` arguments. `Name` is the argument name and `Value` is the corresponding value. `Name` must appear inside quotes. You can specify several name and value pair arguments in any order as `Name1, Value1, ..., NameN, ValueN`.

Example: `[updatedNet, YPred] = classifyAndUpdateState(recNet,C, 'MiniBatchSize',27)` classifies data using mini-batches of size 27.

### MiniBatchSize — Size of mini-batches

128 (default) | positive integer

Size of mini-batches to use for prediction, specified as a positive integer. Larger mini-batch sizes require more memory, but can lead to faster predictions.

When making predictions with sequences of different lengths, the mini-batch size can impact the amount of padding added to the input data which can result in different predicted values. Try using different values to see which works best with your network. To specify mini-batch size and padding options, use the `'MiniBatchSize'` and `'SequenceLength'` options.

Example: `'MiniBatchSize',256`

### Acceleration — Performance optimization

'auto' (default) | 'none'

Performance optimization, specified as the comma-separated pair consisting of `'Acceleration'` and one of the following:

- `'auto'` — Automatically apply a number of optimizations suitable for the input network and hardware resource.
- `'none'` — Disable all acceleration.

The default option is `'auto'`.

Using the 'Acceleration' option 'auto' can offer performance benefits, but at the expense of an increased initial run time. Subsequent calls with compatible parameters are faster. Use performance optimization when you plan to call the function multiple times using new input data.

Example: 'Acceleration', 'auto'

### ExecutionEnvironment — Hardware resource

'auto' (default) | 'gpu' | 'cpu'

Hardware resource, specified as the comma-separated pair consisting of 'ExecutionEnvironment' and one of the following:

- 'auto' — Use a GPU if one is available; otherwise, use the CPU.
- 'gpu' — Use the GPU. Using a GPU requires Parallel Computing Toolbox and a CUDA enabled NVIDIA GPU with compute capability 3.0 or higher. If Parallel Computing Toolbox or a suitable GPU is not available, then the software returns an error.
- 'cpu' — Use the CPU.

Example: 'ExecutionEnvironment', 'cpu'

### SequenceLength — Option to pad, truncate, or split input sequences

'longest' (default) | 'shortest' | positive integer

Option to pad, truncate, or split input sequences, specified as one of the following:

- 'longest' — Pad sequences in each mini-batch to have the same length as the longest sequence. This option does not discard any data, though padding can introduce noise to the network.
- 'shortest' — Truncate sequences in each mini-batch to have the same length as the shortest sequence. This option ensures that no padding is added, at the cost of discarding data.
- Positive integer — For each mini-batch, pad the sequences to the nearest multiple of the specified length that is greater than the longest sequence length in the mini-batch, and then split the sequences into smaller sequences of the specified length. If splitting occurs, then the software creates extra mini-batches. Use this option if the full sequences do not fit in memory. Alternatively, try reducing the number of sequences per mini-batch by setting the 'MiniBatchSize' option to a lower value.

To learn more about the effect of padding, truncating, and splitting the input sequences, see “Sequence Padding, Truncation, and Splitting”.

Example: 'SequenceLength', 'shortest'

### SequencePaddingDirection — Direction of padding or truncation

'right' (default) | 'left'

Direction of padding or truncation, specified as one of the following:

- 'right' — Pad or truncate sequences on the right. The sequences start at the same time step and the software truncates or adds padding to the end of the sequences.
- 'left' — Pad or truncate sequences on the left. The software truncates or adds padding to the start of the sequences so that the sequences end at the same time step.

Because LSTM layers process sequence data one time step at a time, when the layer `OutputMode` property is 'last', any padding in the final time steps can negatively influence the layer output. To

pad or truncate sequence data on the left, set the 'SequencePaddingDirection' option to 'left'.

For sequence-to-sequence networks (when the `OutputMode` property is 'sequence' for each LSTM layer), any padding in the first time steps can negatively influence the predictions for the earlier time steps. To pad or truncate sequence data on the right, set the 'SequencePaddingDirection' option to 'right'.

To learn more about the effect of padding, truncating, and splitting the input sequences, see “Sequence Padding, Truncation, and Splitting”.

**SequencePaddingValue – Value to pad input sequences**

0 (default) | scalar

Value by which to pad input sequences, specified as a scalar. The option is valid only when `SequenceLength` is 'longest' or a positive integer. Do not pad sequences with NaN, because doing so can propagate errors throughout the network.

Example: 'SequencePaddingValue', -1

**Output Arguments**

**updatedNet – Updated network**

SeriesNetwork object | DAGNetwork object

Updated network. `updatedNet` is the same type of network as the input network.

**YPred – Predicted class labels**

categorical vector | cell array of categorical vectors

Predicted class labels, returned as a categorical vector, or a cell array of categorical vectors. The format of `YPred` depends on the type of problem.

The following table describes the format of `YPred`.

Task	Format
Sequence-to-label classification	<i>N</i> -by-1 categorical vector of labels, where <i>N</i> is the number of observations.
Sequence-to-sequence classification	<i>N</i> -by-1 cell array of categorical sequences of labels, where <i>N</i> is the number of observations. Each sequence has the same number of time steps as the corresponding input sequence after applying the <code>SequenceLength</code> option..

For sequence-to-sequence classification problems with one observation, sequences can be a matrix. In this case, `YPred` is a categorical sequence of labels.

**scores – Predicted class scores**

matrix | cell array of matrices

Predicted class scores, returned as a matrix or a cell array of matrices. The format of `scores` depends on the type of problem.

The following table describes the format of `scores`.



Task	Format
Sequence-to-label classification	$N$ -by- $K$ matrix, where $N$ is the number of observations, and $K$ is the number of classes.
Sequence-to-sequence classification	$N$ -by-1 cell array of matrices, where $N$ is the number of observations. The sequences are matrices with $K$ rows, where $K$ is the number of classes. Each sequence has the same number of time steps as the corresponding input sequence after applying the <code>SequenceLength</code> option to each mini-batch independently.

For sequence-to-sequence classification problems with one observation, `sequences` can be a matrix. In this case, `scores` is a matrix of predicted class scores.

## Algorithms

All functions for deep learning training, prediction, and validation in Deep Learning Toolbox perform computations using single-precision, floating-point arithmetic. Functions for deep learning include `trainNetwork`, `predict`, `classify`, and `activations`. The software uses single-precision arithmetic when you train networks using both CPUs and GPUs.

## References

- [1] M. Kudo, J. Toyama, and M. Shimbo. "Multidimensional Curve Classification Using Passing-Through Regions." *Pattern Recognition Letters*. Vol. 20, No. 11-13, pages 1103-1111.
- [2] *UCI Machine Learning Repository: Japanese Vowels Dataset*. <https://archive.ics.uci.edu/ml/datasets/Japanese+Vowels>

## See Also

`bilstmLayer` | `classify` | `gruLayer` | `lstmLayer` | `predict` | `predictAndUpdateState` | `resetState` | `sequenceInputLayer`

## Topics

"Sequence Classification Using Deep Learning"  
 "Visualize Activations of LSTM Network"  
 "Long Short-Term Memory Networks"  
 "Specify Layers of Convolutional Neural Network"  
 "Set Up Parameters and Train Convolutional Neural Network"  
 "Deep Learning in MATLAB"

## Introduced in R2017b

## clippedReluLayer

Clipped Rectified Linear Unit (ReLU) layer

### Description

A clipped ReLU layer performs a threshold operation, where any input value less than zero is set to zero and any value above the *clipping ceiling* is set to that clipping ceiling.

This operation is equivalent to:

$$f(x) = \begin{cases} 0, & x < 0 \\ x, & 0 \leq x < \textit{ceiling} \\ \textit{ceiling}, & x \geq \textit{ceiling} \end{cases}$$

This clipping prevents the output from becoming too large.

### Creation

#### Syntax

```
layer = clippedReluLayer(ceiling)
layer = clippedReluLayer(ceiling, 'Name', Name)
```

#### Description

`layer = clippedReluLayer(ceiling)` returns a clipped ReLU layer with the clipping ceiling equal to `ceiling`.

`layer = clippedReluLayer(ceiling, 'Name', Name)` sets the optional `Name` property.

### Properties

#### Clipped ReLU

##### Ceiling — Ceiling for input clipping

positive scalar

Ceiling for input clipping, specified as a positive scalar.

Example: 10

#### Layer

##### Name — Layer name

' ' (default) | character vector | string scalar

Layer name, specified as a character vector or a string scalar. To include a layer in a layer graph, you must specify a nonempty unique layer name. If you train a series network with the layer and Name is set to '', then the software automatically assigns a name to the layer at training time.

Data Types: char | string

### **NumInputs — Number of inputs**

1 (default)

Number of inputs of the layer. This layer accepts a single input only.

Data Types: double

### **InputNames — Input names**

{'in'} (default)

Input names of the layer. This layer accepts a single input only.

Data Types: cell

### **NumOutputs — Number of outputs**

1 (default)

Number of outputs of the layer. This layer has a single output only.

Data Types: double

### **OutputNames — Output names**

{'out'} (default)

Output names of the layer. This layer has a single output only.

Data Types: cell

## **Examples**

### **Create Clipped ReLU Layer**

Create a clipped ReLU layer with the name 'clip1' and the clipping ceiling equal to 10.

```
layer = clippedReluLayer(10,'Name','clip1')
```

```
layer =  
    ClippedReLULayer with properties:
```

```
        Name: 'clip1'
```

```
    Hyperparameters
```

```
        Ceiling: 10
```

Include a clipped ReLU layer in a Layer array.

```
layers = [ ...  
    imageInputLayer([28 28 1])  
    convolution2dLayer(5,20)  
    clippedReluLayer(10)
```

```
maxPooling2dLayer(2, 'Stride', 2)
fullyConnectedLayer(10)
softmaxLayer
classificationLayer]

layers =
    7x1 Layer array with layers:

    1 '' Image Input          28x28x1 images with 'zerocenter' normalization
    2 '' Convolution         20 5x5 convolutions with stride [1 1] and padding [0 0 0 0]
    3 '' Clipped ReLU        Clipped ReLU with ceiling 10
    4 '' Max Pooling         2x2 max pooling with stride [2 2] and padding [0 0 0 0]
    5 '' Fully Connected     10 fully connected layer
    6 '' Softmax              softmax
    7 '' Classification Output crossentropyex
```

## References

- [1] Hannun, Awni, Carl Case, Jared Casper, Bryan Catanzaro, Greg Diamos, Erich Elsen, Ryan Prenger, et al. "Deep speech: Scaling up end-to-end speech recognition." Preprint, submitted 17 Dec 2014. <http://arxiv.org/abs/1412.5567>

## Extended Capabilities

### GPU Code Generation

Generate CUDA® code for NVIDIA® GPUs using GPU Coder™.

## See Also

[leakyReluLayer](#) | [reluLayer](#)

### Topics

"Create Simple Deep Learning Network for Classification"  
"Train Convolutional Neural Network for Regression"  
"Deep Learning in MATLAB"  
"Specify Layers of Convolutional Neural Network"  
"List of Deep Learning Layers"

### Introduced in R2017b

# concatenationLayer

Concatenation layer

## Description

A concatenation layer takes inputs and concatenates them along a specified dimension. The inputs must have the same size in all dimensions except the concatenation dimension.

Specify the number of inputs to the layer when you create it. The inputs have the names 'in1', 'in2', ..., 'inN', where N is the number of inputs. Use the input names when connecting or disconnecting the layer by using `connectLayers` or `disconnectLayers`.

## Creation

### Syntax

```
layer = concatenationLayer(dim,numInputs)
layer = concatenationLayer(dim,numInputs,'Name',name)
```

### Description

`layer = concatenationLayer(dim,numInputs)` creates a concatenation layer that concatenates `numInputs` inputs along the specified dimension, `dim`. This function also sets the `Dim` and `NumInputs` properties.

`layer = concatenationLayer(dim,numInputs,'Name',name)` also sets the `Name` property. To create a network containing a concatenation layer, you must specify a layer name.

## Properties

### Concatenation

#### Dim — Concatenation dimension

positive integer

Concatenation dimension, specified as a positive integer.

Example: 4

### Layer

#### Name — Layer name

' ' (default) | character vector | string scalar

Layer name, specified as a character vector or a string scalar. To include this layer in a layer graph, you must specify a layer name.

Data Types: char | string

**NumInputs — Number of inputs**

positive integer

Number of inputs to the layer, specified as a positive integer.

The inputs have the names 'in1', 'in2', ..., 'inN', where N equals NumInputs. For example, if NumInputs equals 3, then the inputs have the names 'in1', 'in2', and 'in3'. Use the input names when connecting or disconnecting the layer by using `connectLayers` or `disconnectLayers`.

**InputNames — Input Names**`{'in1','in2',...,'inN'}` (default)

Input names, specified as `{'in1','in2',...,'inN'}`, where N is the number of inputs of the layer.

Data Types: `cell`**NumOutputs — Number of outputs**

1 (default)

Number of outputs of the layer. This layer has a single output only.

Data Types: `double`**OutputNames — Output names**`{'out'}` (default)

Output names of the layer. This layer has a single output only.

Data Types: `cell`**Examples****Create and Connect Concatenation Layer**

Create a concatenation layer that concatenates two inputs along the fourth dimension (channels). Name the concatenation layer 'concat'.

```
concat = concatenationLayer(4,2,'Name','concat')
```

```
concat =  
ConcatenationLayer with properties:
```

```
    Name: 'concat'  
    Dim: 4  
    NumInputs: 2  
    InputNames: {'in1' 'in2'}
```

Create two ReLU layers and connect them to the concatenation layer. The concatenation layer concatenates the outputs from the ReLU layers.

```
relu_1 = reluLayer('Name','relu_1');  
relu_2 = reluLayer('Name','relu_2');
```

```
lgraph = layerGraph();
```

```
lgraph = addLayers(lgraph, relu_1);  
lgraph = addLayers(lgraph, relu_2);  
lgraph = addLayers(lgraph, concat);  
  
lgraph = connectLayers(lgraph, 'relu_1', 'concat/in1');  
lgraph = connectLayers(lgraph, 'relu_2', 'concat/in2');  
plot(lgraph)
```

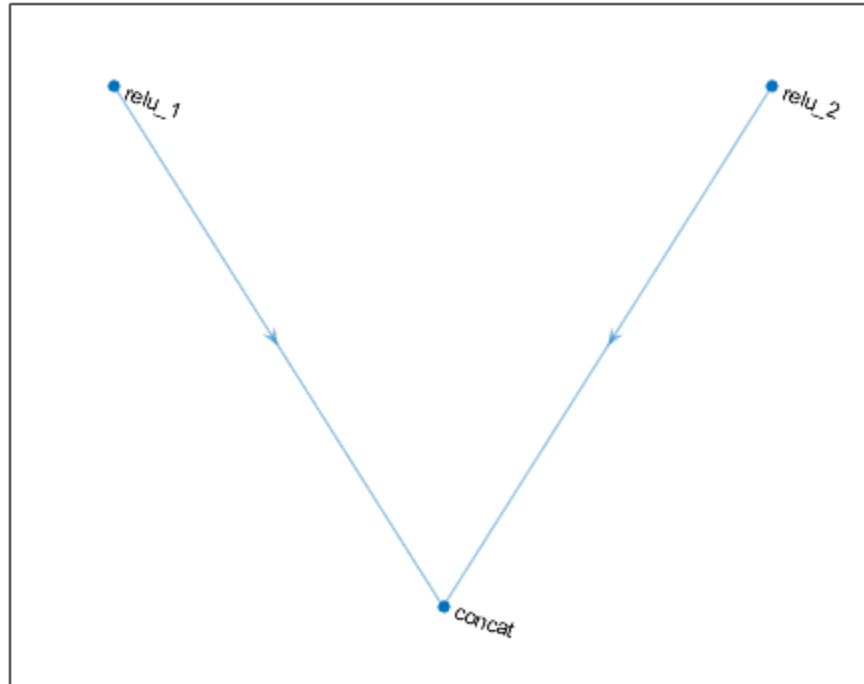

## See Also

[additionLayer](#) | [connectLayers](#) | [disconnectLayers](#) | [layerGraph](#) | [trainNetwork](#)

## Topics

“3-D Brain Tumor Segmentation Using Deep Learning”

“Pretrained Deep Neural Networks”

“List of Deep Learning Layers”

## Introduced in R2019a

## confusionchart

Create confusion matrix chart for classification problem

### Syntax

```
confusionchart(trueLabels,predictedLabels)
confusionchart(m)
confusionchart(m,classLabels)
confusionchart(parent,___)
confusionchart(___,Name,Value)
cm = confusionchart(___)
```

### Description

`confusionchart(trueLabels,predictedLabels)` creates a confusion matrix chart from true labels `trueLabels` and predicted labels `predictedLabels` and returns a `ConfusionMatrixChart` object. The rows of the confusion matrix correspond to the true class and the columns correspond to the predicted class. Diagonal and off-diagonal cells correspond to correctly and incorrectly classified observations, respectively. Use `cm` to modify the confusion matrix chart after it is created. For a list of properties, see `ConfusionMatrixChart` Properties.

`confusionchart(m)` creates a confusion matrix chart from the numeric confusion matrix `m`. Use this syntax if you already have a numeric confusion matrix in the workspace.

`confusionchart(m,classLabels)` specifies class labels that appear along the x-axis and y-axis. Use this syntax if you already have a numeric confusion matrix and class labels in the workspace.

`confusionchart(parent,___)` creates the confusion chart in the figure, panel, or tab specified by `parent`.

`confusionchart(___,Name,Value)` specifies additional `ConfusionMatrixChart` properties using one or more name-value pair arguments. Specify the properties after all other input arguments. For a list of properties, see `ConfusionMatrixChart` Properties.

`cm = confusionchart(___)` returns the `ConfusionMatrixChart` object. Use `cm` to modify properties of the chart after creating it. For a list of properties, see `ConfusionMatrixChart` Properties.

### Examples

#### Create Confusion Matrix Chart

Load a sample of predicted and true labels for a classification problem. `trueLabels` is the true labels for an image classification problem and `predictedLabels` is the predictions of a convolutional neural network.

```
load('Cifar10Labels.mat','trueLabels','predictedLabels');
```

Create a confusion matrix chart.



figure

```
cm = confusionchart(trueLabels,predictedLabels);
```

True Class	airplane	923	4	21	8	4	1	5	5	23	6
	automobile	5	972	2					1	5	15
	bird	26	2	892	30	13	8	17	5	4	3
	cat	12	4	32	826	24	48	30	12	5	7
	deer	5	1	28	24	898	13	14	14	2	1
	dog	7	2	28	111	18	801	13	17		3
	frog	5		16	27	3	4	943	1	1	
	horse	9	1	14	13	22	17	3	915	2	4
	ship	37	10	4	4		1	2	1	931	10
	truck	20	39	3	3			2	1	9	923
		airplane	automobile	bird	cat	deer	dog	frog	horse	ship	truck
		Predicted Class									

Modify the appearance and behavior of the confusion matrix chart by changing property values. Add column and row summaries and a title. A column-normalized column summary displays the number of correctly and incorrectly classified observations for each predicted class as percentages of the number of observations of the corresponding predicted class. A row-normalized row summary displays the number of correctly and incorrectly classified observations for each true class as percentages of the number of observations of the corresponding true class.

```
cm.ColumnSummary = 'column-normalized';
cm.RowSummary = 'row-normalized';
cm.Title = 'CIFAR-10 Confusion Matrix';
```

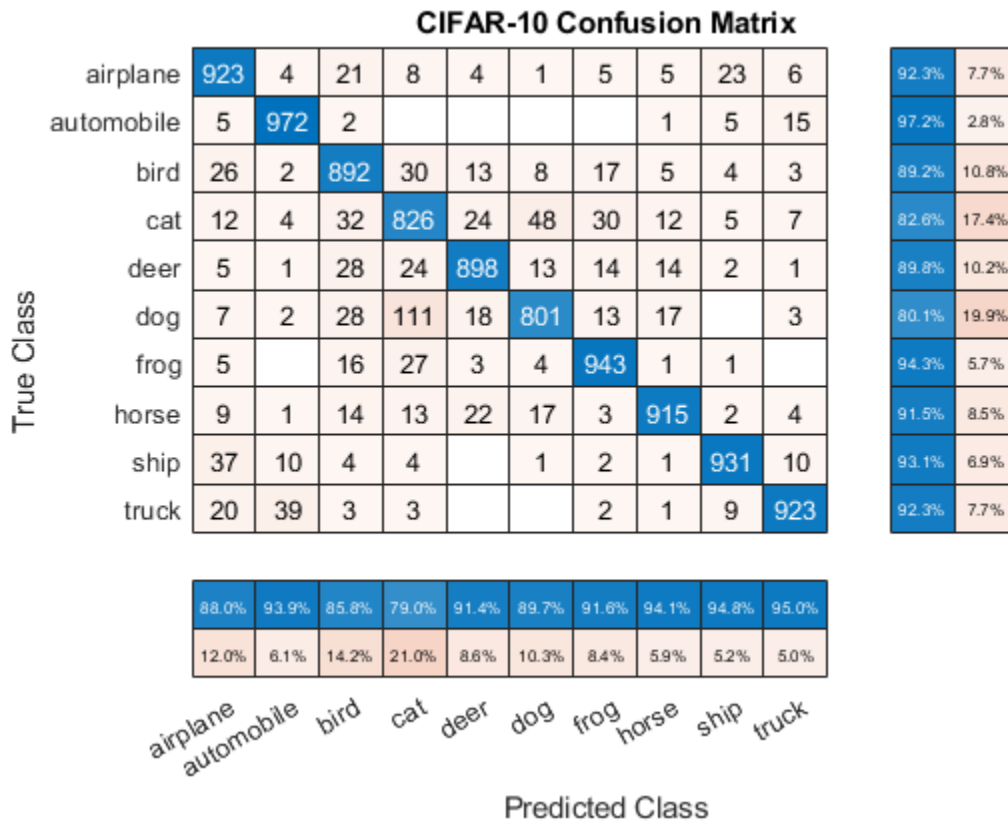

### Create Confusion Matrix Chart from Numeric Confusion Matrix

You can use `confusionchart` to create a confusion matrix chart from a numeric confusion matrix.

Load a sample confusion matrix `m` and the associated class labels `classLabels`.

```
load('Cifar10ConfusionMat.mat', 'm', 'classLabels');
m
```

`m = 10x10`

923	4	21	8	4	1	5	5	23	6
5	972	2	0	0	0	0	1	5	15
26	2	892	30	13	8	17	5	4	3
12	4	32	826	24	48	30	12	5	7
5	1	28	24	898	13	14	14	2	1
7	2	28	111	18	801	13	17	0	3
5	0	16	27	3	4	943	1	1	0
9	1	14	13	22	17	3	915	2	4
37	10	4	4	0	1	2	1	931	10
20	39	3	3	0	0	2	1	9	923

`classLabels`

```

classLabels = 10x1 categorical
  airplane
  automobile
  bird
  cat
  deer
  dog
  frog
  horse
  ship
  truck

```

Create a confusion matrix chart from the numeric confusion matrix and the class labels.

```
cm = confusionchart(m,classLabels);
```

True Class	airplane	923	4	21	8	4	1	5	5	23	6
	automobile	5	972	2					1	5	15
	bird	26	2	892	30	13	8	17	5	4	3
	cat	12	4	32	826	24	48	30	12	5	7
	deer	5	1	28	24	898	13	14	14	2	1
	dog	7	2	28	111	18	801	13	17		3
	frog	5		16	27	3	4	943	1	1	
	horse	9	1	14	13	22	17	3	915	2	4
	ship	37	10	4	4		1	2	1	931	10
	truck	20	39	3	3			2	1	9	923
		airplane	automobile	bird	cat	deer	dog	frog	horse	ship	truck
		Predicted Class									

### Sort Classes by Precision or Recall

Load a sample of predicted and true labels for a classification problem. `trueLabels` are the true labels for an image classification problem and `predictedLabels` are the predictions of a convolutional neural network. Create a confusion matrix chart with column and row summaries

```

load('Cifar10Labels.mat','trueLabels','predictedLabels');
figure

```

```
cm = confusionchart(trueLabels,predictedLabels, ...
    'ColumnSummary','column-normalized', ...
    'RowSummary','row-normalized');
```

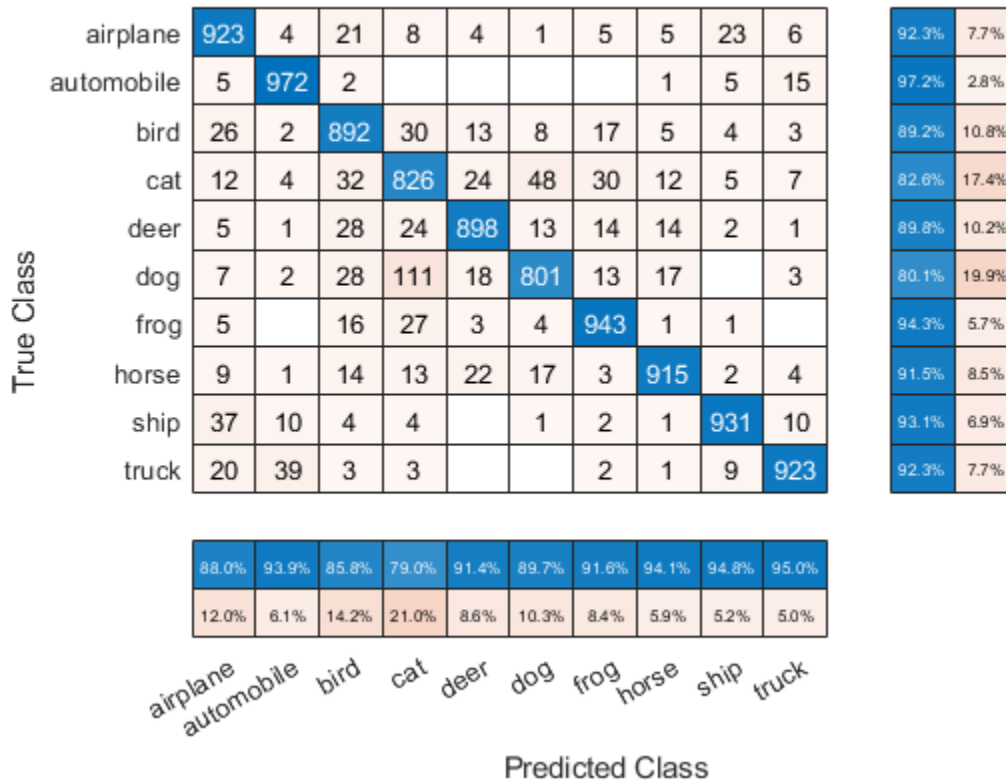

To sort the classes of the confusion matrix by class-wise recall (true positive rate), normalize the cell values across each row, that is, by the number of observations that have the same true class. Sort the classes by the corresponding diagonal cell values and reset the normalization of the cell values. The classes are now sorted such that the percentages in the blue cells in the row summaries to the right are decreasing.

```
cm.Normalization = 'row-normalized';
sortClasses(cm,'descending-diagonal');
cm.Normalization = 'absolute';
```

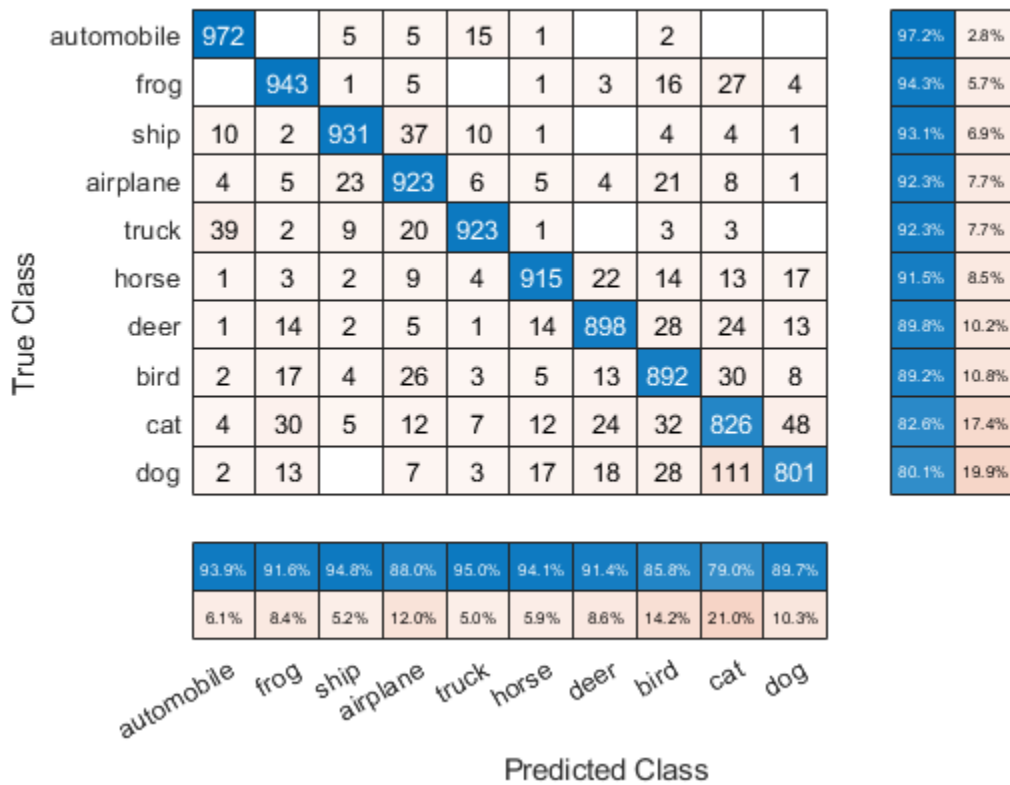

To sort the classes by class-wise precision (positive predictive value), normalize the cell values across each column, that is, by the number of observations that have the same predicted class. Sort the classes by the corresponding diagonal cell values and reset the normalization of the cell values. The classes are now sorted such that the percentages in the blue cells in the column summaries at the bottom are decreasing.

```
cm.Normalization = 'column-normalized';
sortClasses(cm, 'descending-diagonal');
cm.Normalization = 'absolute';
```

True Class	truck	923	9	1	39	2			20	3	3	92.3%	7.7%
	ship	10	931	1	10	2		1	37	4	4	93.1%	6.9%
	horse	4	2	915	1	3	22	17	9	14	13	91.5%	8.5%
	automobile	15	5	1	972				5	2		97.2%	2.8%
	frog		1	1		943	3	4	5	16	27	94.3%	5.7%
	deer	1	2	14	1	14	898	13	5	28	24	89.8%	10.2%
	dog	3		17	2	13	18	801	7	28	111	80.1%	19.9%
	airplane	6	23	5	4	5	4	1	923	21	8	92.3%	7.7%
	bird	3	4	5	2	17	13	8	26	892	30	89.2%	10.8%
	cat	7	5	12	4	30	24	48	12	32	826	82.6%	17.4%

95.0%	94.8%	94.1%	93.9%	91.6%	91.4%	89.7%	88.0%	85.8%	79.0%
5.0%	5.2%	5.9%	6.1%	8.4%	8.6%	10.3%	12.0%	14.2%	21.0%

truck ship horse automobile frog deer dog airplane bird cat  
 Predicted Class

## Input Arguments

### trueLabels – True labels of classification problem

categorical vector | numeric vector | string vector | character array | cell array of character vectors | logical vector

True labels of classification problem, specified as a categorical vector, numeric vector, string vector, character array, cell array of character vectors, or logical vector. If trueLabels is a vector, then each element corresponds to one observation. If trueLabels is a character array, then it must be two-dimensional with each row corresponding to the label of one observation.

### predictedLabels – Predicted labels of classification problem

categorical vector | numeric vector | string vector | character array | cell array of character vectors | logical vector

Predicted labels of classification problem, specified as a categorical vector, numeric vector, string vector, character array, cell array of character vectors, or logical vector. If predictedLabels is a vector, then each element corresponds to one observation. If predictedLabels is a character array, then it must be two-dimensional with each row corresponding to the label of one observation.

### m – Confusion matrix

matrix

Confusion matrix, specified as a matrix. m must be square and its elements must be positive integers. The element  $m(i, j)$  is the number of times an observation of the  $i$ th true class was predicted to be

of the  $j$ th class. Each colored cell of the confusion matrix chart corresponds to one element of the confusion matrix  $m$ .

### **classLabels — Class labels**

categorical vector | numeric vector | string vector | character array | cell array of character vectors | logical vector

Class labels of the confusion matrix chart, specified as a categorical vector, numeric vector, string vector, character array, cell array of character vectors, or logical vector. If `classLabels` is a vector, then it must have the same number of elements as the confusion matrix has rows and columns. If `classLabels` is a character array, then it must be two-dimensional with each row corresponding to the label of one class.

### **parent — Parent container**

Figure object | Panel object | Tab object

Parent container in which to plot, specified as a Figure, Panel, or Tab object.

### **Name-Value Pair Arguments**

Specify optional comma-separated pairs of `Name`, `Value` arguments. `Name` is the argument name and `Value` is the corresponding value. `Name` must appear inside quotes. You can specify several name and value pair arguments in any order as `Name1, Value1, ..., NameN, ValueN`.

Example: `cm = confusionchart(trueLabels, predictedLabels, 'Title', 'My Title Text', 'ColumnSummary', 'column-normalized')`

---

**Note** The properties listed here are only a subset. For a complete list, see `ConfusionMatrixChart Properties`.

---

### **Title — Title**

' ' (default) | character vector | string scalar

Title of the confusion matrix chart, specified as a character vector or string scalar.

Example: `cm = confusionchart(__, 'Title', 'My Title Text')`

Example: `cm.Title = 'My Title Text'`

### **ColumnSummary — Column summary**

'off' (default) | 'absolute' | 'column-normalized' | 'total-normalized'

Column summary of the confusion matrix chart, specified as one of the following:

Option	Description
'off'	Do not display a column summary.
'absolute'	Display the total number of correctly and incorrectly classified observations for each predicted class.

Option	Description
'column-normalized'	Display the number of correctly and incorrectly classified observations for each predicted class as percentages of the number of observations of the corresponding predicted class. The percentages of correctly classified observations can be thought of as class-wise precisions (or positive predictive values).
'total-normalized'	Display the number of correctly and incorrectly classified observations for each predicted class as percentages of the total number of observations.

Example: `cm = confusionchart(__, 'ColumnSummary', 'column-normalized')`

Example: `cm.ColumnSummary = 'column-normalized'`

### RowSummary – Row summary

'off' (default) | 'absolute' | 'row-normalized' | 'total-normalized'

Row summary of the confusion matrix chart, specified as one of the following:

Option	Description
'off'	Do not display a row summary.
'absolute'	Display the total number of correctly and incorrectly classified observations for each true class.
'row-normalized'	Display the number of correctly and incorrectly classified observations for each true class as percentages of the number of observations of the corresponding true class. The percentages of correctly classified observations can be thought of as class-wise recalls (or true positive rates).
'total-normalized'	Display the number of correctly and incorrectly classified observations for each true class as percentages of the total number of observations.

Example: `cm = confusionchart(__, 'RowSummary', 'row-normalized')`

Example: `cm.RowSummary = 'row-normalized'`

### Normalization – Normalization of cell values

'absolute' (default) | 'column-normalized' | 'row-normalized' | 'total-normalized'

Normalization of cell values, specified as one of the following:

Option	Description
'absolute'	Display the total number of observations in each cell.
'column-normalized'	Normalize each cell value by the number of observations that has the same predicted class.



Option	Description
'row-normalized'	Normalize each cell value by the number of observations that has the same true class.
'total-normalized'	Normalize each cell value by the total number of observations.

Modifying the normalization of cell values also affects the colors of the cells.

Example: `cm = confusionchart(__, 'Normalization', 'total-normalized')`

Example: `cm.Normalization = 'total-normalized'`

## Limitations

- MATLAB code generation is not supported for `ConfusionMatrixChart` objects.

## Tips

- If you have Statistics and Machine Learning Toolbox™, you can create a confusion matrix chart for tall arrays. For details, see `confusionchart` and “Confusion Matrix for Classification Using Tall Arrays” (Statistics and Machine Learning Toolbox).

## See Also

### Functions

`categorical` | `classify` | `confusionmat` | `sortClasses`

### Properties

`ConfusionMatrixChart` Properties

### Topics

“Deep Learning in MATLAB”

### Introduced in R2018b

## confusionmat

Compute confusion matrix for classification problem

### Syntax

```
C = confusionmat(group,grouphat)
C = confusionmat(group,grouphat,'Order',grouporder)
[C,order] = confusionmat(____)
```

### Description

`C = confusionmat(group,grouphat)` returns the confusion matrix `C` determined by the known and predicted groups in `group` and `grouphat`, respectively.

`C = confusionmat(group,grouphat,'Order',grouporder)` uses `grouporder` to order the rows and columns of `C`.

`[C,order] = confusionmat(____)` also returns the order of the rows and columns of `C` in the variable `order` using any of the input arguments in previous syntaxes.

### Examples

#### Calculate Confusion Matrix

Load a sample of predicted and true labels for a classification problem. `trueLabels` are the true labels for an image classification problem and `predictedLabels` are the predictions of a convolutional neural network.

```
load('Cifar10Labels.mat','trueLabels','predictedLabels');
```

Calculate the numeric confusion matrix. `order` is the order of the classes in the confusion matrix.

```
[m,order] = confusionmat(trueLabels,predictedLabels)
```

```
m = 10x10
```

```
923    4    21    8    4    1    5    5    23    6
    5   972    2    0    0    0    0    1    5   15
   26    2   892   30   13    8   17    5    4    3
   12    4    32  826   24   48   30   12    5    7
    5    1    28   24  898   13   14   14    2    1
    7    2    28  111   18  801   13   17    0    3
    5    0   16   27    3    4  943    1    1    0
    9    1   14   13   22   17    3  915    2    4
   37   10    4    4    0    1    2    1  931   10
   20   39    3    3    0    0    2    1    9  923
```

```
order = 10x1 categorical
    airplane
    automobile
```

```

bird
cat
deer
dog
frog
horse
ship
truck

```

You can use `confusionchart` to plot a the confusion matrix as a confusion matrix chart.

```

figure
cm = confusionchart(m,order);

```

True Class	airplane	923	4	21	8	4	1	5	5	23	6
	automobile	5	972	2					1	5	15
	bird	26	2	892	30	13	8	17	5	4	3
	cat	12	4	32	826	24	48	30	12	5	7
	deer	5	1	28	24	898	13	14	14	2	1
	dog	7	2	28	111	18	801	13	17		3
	frog	5		16	27	3	4	943	1	1	
	horse	9	1	14	13	22	17	3	915	2	4
	ship	37	10	4	4		1	2	1	931	10
	truck	20	39	3	3			2	1	9	923
		Predicted Class									

You do not need to calculate the confusion matrix first and then plot it. Instead, plot a confusion matrix chart directly from the true and predicted labels. You can also add column and row summaries and a title.

```

figure
cm = confusionchart(trueLabels,predictedLabels, ...
    'Title','My Title', ...
    'RowSummary','row-normalized', ...
    'ColumnSummary','column-normalized');

```

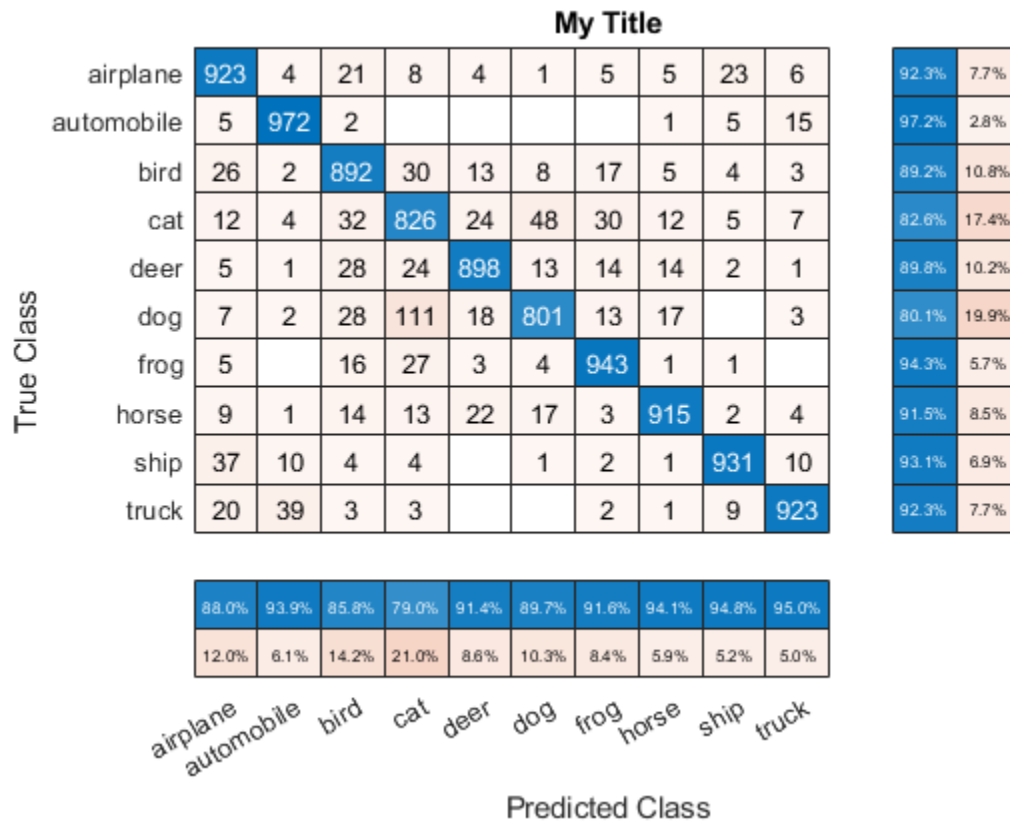

The ConfusionMatrixChart object stores the numeric confusion matrix in the NormalizedValues property and classes in the ClassLabels property.

cm.NormalizedValues

ans = 10x10

923	4	21	8	4	1	5	5	23	6
5	972	2	0	0	0	0	1	5	15
26	2	892	30	13	8	17	5	4	3
12	4	32	826	24	48	30	12	5	7
5	1	28	24	898	13	14	14	2	1
7	2	28	111	18	801	13	17	0	3
5	0	16	27	3	4	943	1	1	0
9	1	14	13	22	17	3	915	2	4
37	10	4	4	0	1	2	1	931	10
20	39	3	3	0	0	2	1	9	923

cm.ClassLabels

ans = 10x1 categorical

airplane  
 automobile  
 bird  
 cat  
 deer  
 dog

```
frog
horse
ship
truck
```

## Input Arguments

### group — Known groups

numeric vector | logical vector | character array | string array | cell array of character vectors | categorical vector

Known groups for categorizing observations, specified as a numeric vector, logical vector, character array, string array, cell array of character vectors, or categorical vector.

`group` is a grouping variable of the same type as `grouphat`. The `group` argument must have the same number of observations as `grouphat`, as described in “Grouping Variables” (Statistics and Machine Learning Toolbox). The `confusionmat` function treats character arrays and string arrays as cell arrays of character vectors. Additionally, `confusionmat` treats NaN, empty, and 'undefined' values in `group` as missing values and does not count them as distinct groups or categories.

Example: {'Male', 'Female', 'Female', 'Male', 'Female'}

Data Types: single | double | logical | char | string | cell | categorical

### grouphat — Predicted groups

numeric vector | logical vector | character array | string array | cell array of character vectors | categorical vector

Predicted groups for categorizing observations, specified as a numeric vector, logical vector, character array, string array, cell array of character vectors, or categorical vector.

`grouphat` is a grouping variable of the same type as `group`. The `grouphat` argument must have the same number of observations as `group`, as described in “Grouping Variables” (Statistics and Machine Learning Toolbox). The `confusionmat` function treats character arrays and string arrays as cell arrays of character vectors. Additionally, `confusionmat` treats NaN, empty, and 'undefined' values in `grouphat` as missing values and does not count them as distinct groups or categories.

Example: [1 0 0 1 0]

Data Types: single | double | logical | char | string | cell | categorical

### grouporder — Group order

numeric vector | logical vector | character array | string array | cell array of character vectors | categorical vector

Group order, specified as a numeric vector, logical vector, character array, string array, cell array of character vectors, or categorical vector.

`grouporder` is a grouping variable containing all the distinct elements in `group` and `grouphat`. Specify `grouporder` to define the order of the rows and columns of `C`. If `grouporder` contains elements that are not in `group` or `grouphat`, the corresponding entries in `C` are 0.

By default, the group order depends on the data type of `s = [group;grouphat]`:

- For numeric and logical vectors, the order is the sorted order of `s`.
- For categorical vectors, the order is the order returned by `categories(s)`.
- For other data types, the order is the order of first appearance in `s`.

Example: `'order',{'setosa','versicolor','virginica'}`

Data Types: `single | double | logical | char | string | cell | categorical`

## Output Arguments

### **C** — Confusion matrix

matrix

Confusion matrix, returned as a square matrix with size equal to the total number of distinct elements in the `group` and `grouphat` arguments.  $C(i, j)$  is the count of observations known to be in group `i` but predicted to be in group `j`.

The rows and columns of `C` have identical ordering of the same group indices. By default, the group order depends on the data type of `s = [group;grouphat]`:

- For numeric and logical vectors, the order is the sorted order of `s`.
- For categorical vectors, the order is the order returned by `categories(s)`.
- For other data types, the order is the order of first appearance in `s`.

To change the order, specify `grouporder`,

The `confusionmat` function treats `NaN`, empty, and `'undefined'` values in the grouping variables as missing values and does not include them in the rows and columns of `C`.

### **order** — Order of rows and columns

numeric vector | logical vector | categorical vector | cell array of character vectors

Order of rows and columns in `C`, returned as a numeric vector, logical vector, categorical vector, or cell array of character vectors. If `group` and `grouphat` are character arrays, string arrays, or cell arrays of character vectors, then the variable `order` is a cell array of character vectors. Otherwise, `order` is of the same type as `group` and `grouphat`.

## Alternative Functionality

- Use `confusionchart` to calculate and plot a confusion matrix. Additionally, `confusionchart` displays summary statistics about your data and sorts the classes of the confusion matrix according to the class-wise precision (positive predictive value), class-wise recall (true positive rate), or total number of correctly classified observations.

## See Also

`categories` | `classify` | `confusionchart`

### Topics

“Deep Learning in MATLAB”

# ConfusionMatrixChart Properties

Confusion matrix chart appearance and behavior

## Description

ConfusionMatrixChart properties control the appearance and behavior of a ConfusionMatrixChart object. By changing property values, you can modify certain aspects of the confusion matrix chart. For example, you can add a title:

```
cm = confusionchart([1 3 5; 2 4 6; 11 7 3]);
cm.Title = 'My Confusion Matrix Title';
```

## Properties

### Labels

#### Title — Title

' ' (default) | character vector | string scalar

Title of the confusion matrix chart, specified as a character vector or string scalar.

Example: `cm = confusionchart(__, 'Title', 'My Title Text')`

Example: `cm.Title = 'My Title Text'`

#### XLabel — Label for x-axis

'Predicted class' (default) | string scalar | character vector

Label for the x-axis, specified as a string scalar or character vector.

Example: `cm = confusionchart(__, 'XLabel', 'My Label')`

Example: `cm.XLabel = 'My Label'`

#### YLabel — Label for y-axis

'True class' (default) | string scalar | character vector

Label for the x-axis, specified as a string scalar or character vector.

Example: `cm = confusionchart(__, 'YLabel', 'My Label')`

Example: `cm.YLabel = 'My Label'`

#### ClassLabels — Class labels

categorical vector | numeric vector | string vector | character array | cell array of character vectors | logical vector

This property is read-only.

Class labels of the confusion matrix chart, stored as a categorical vector, numeric vector, string vector, character array, cell array of character vectors, or logical vector.

**Row and Column Summaries****ColumnSummary – Column summary**

'off' (default) | 'absolute' | 'column-normalized' | 'total-normalized'

Column summary of the confusion matrix chart, specified as one of the following:

Option	Description
'off'	Do not display a column summary.
'absolute'	Display the total number of correctly and incorrectly classified observations for each predicted class.
'column-normalized'	Display the number of correctly and incorrectly classified observations for each predicted class as percentages of the number of observations of the corresponding predicted class. The percentages of correctly classified observations can be thought of as class-wise precisions (or positive predictive values).
'total-normalized'	Display the number of correctly and incorrectly classified observations for each predicted class as percentages of the total number of observations.

Example: `cm = confusionchart(__, 'ColumnSummary', 'column-normalized')`

Example: `cm.ColumnSummary = 'column-normalized'`

**RowSummary – Row summary**

'off' (default) | 'absolute' | 'row-normalized' | 'total-normalized'

Row summary of the confusion matrix chart, specified as one of the following:

Option	Description
'off'	Do not display a row summary.
'absolute'	Display the total number of correctly and incorrectly classified observations for each true class.
'row-normalized'	Display the number of correctly and incorrectly classified observations for each true class as percentages of the number of observations of the corresponding true class. The percentages of correctly classified observations can be thought of as class-wise recalls (or true positive rates).
'total-normalized'	Display the number of correctly and incorrectly classified observations for each true class as percentages of the total number of observations.

Example: `cm = confusionchart(__, 'RowSummary', 'row-normalized')`

Example: `cm.RowSummary = 'row-normalized'`



**Data****NormalizedValues — Values of the confusion matrix**

numeric matrix

This property is read-only.

Values of the confusion matrix, stored as a numeric matrix. This property equals the values of the confusion matrix normalized using the method of the `Normalization` property. The software recalculates the normalized values of the confusion matrix each time you modify the `Normalization` property.

**Normalization — Normalization of cell values**

'absolute' (default) | 'column-normalized' | 'row-normalized' | 'total-normalized'

Normalization of cell values, specified as one of the following:

Option	Description
'absolute'	Display the total number of observations in each cell.
'column-normalized'	Normalize each cell value by the number of observations that has the same predicted class.
'row-normalized'	Normalize each cell value by the number of observations that has the same true class.
'total-normalized'	Normalize each cell value by the total number of observations.

Modifying the normalization of cell values also affects the colors of the cells.

Example: `cm = confusionchart(__, 'Normalization', 'total-normalized')`

Example: `cm.Normalization = 'total-normalized'`

**Color and Styling****GridVisible — State of grid visibility**

'on' (default) | on/off logical value

State of grid visibility, specified as 'on' or 'off', or as numeric or logical 1 (true) or 0 (false). A value of 'on' is equivalent to true, and 'off' is equivalent to false. Thus, you can use the value of this property as a logical value. The value is stored as an on/off logical value of type `matlab.lang.OnOffSwitchState`.

- 'on' — Display grid lines between the chart cells.
- 'off' — Do not display grid lines between the chart cells.

Example: `cm = confusionchart(__, 'GridVisible', 'off')`

Example: `cm.GridVisible = 'off'`

**DiagonalColor — Color for diagonal cells**

[0 0.4471 0.7412] (default) | RGB triplet | hexadecimal color code | 'r' | 'g' | 'b' | ...







Color for diagonal cells, specified as an RGB triplet, a hexadecimal color code, a color name, or a short name. The color of each diagonal cell is proportional to the cell value and the `DiagonalColor`

property, normalized to the largest cell value of the confusion matrix chart. Cells with positive values are colored with a minimum amount of color, proportional to the `DiagonalColor` property.





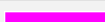
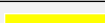

RGB triplets and hexadecimal color codes are useful for specifying custom colors.

- An RGB triplet is a three-element row vector whose elements specify the intensities of the red, green, and blue components of the color. The intensities must be in the range  $[0, 1]$ ; for example,  $[0.4 \ 0.6 \ 0.7]$ .
- A hexadecimal color code is a character vector or a string scalar that starts with a hash symbol (#) followed by three or six hexadecimal digits, which can range from 0 to F. The values are not case sensitive. Thus, the color codes '#FF8800', '#ff8800', '#F80', and '#f80' are equivalent.

Alternatively, you can specify some common colors by name. This table lists the named color options, the equivalent RGB triplets, and hexadecimal color codes.

Color Name	Short Name	RGB Triplet	Hexadecimal Color Code	Appearance
'red'	'r'	[1 0 0]	'#FF0000'	
'green'	'g'	[0 1 0]	'#00FF00'	
'blue'	'b'	[0 0 1]	'#0000FF'	
'cyan'	'c'	[0 1 1]	'#00FFFF'	
'magenta'	'm'	[1 0 1]	'#FF00FF'	
'yellow'	'y'	[1 1 0]	'#FFFF00'	
'black'	'k'	[0 0 0]	'#000000'	
'white'	'w'	[1 1 1]	'#FFFFFF'	

Here are the RGB triplets and hexadecimal color codes for the default colors MATLAB uses in many types of plots.

RGB Triplet	Hexadecimal Color Code	Appearance
[0 0.4470 0.7410]	'#0072BD'	
[0.8500 0.3250 0.0980]	'#D95319'	
[0.9290 0.6940 0.1250]	'#EDB120'	
[0.4940 0.1840 0.5560]	'#7E2F8E'	
[0.4660 0.6740 0.1880]	'#77AC30'	
[0.3010 0.7450 0.9330]	'#4DBEEE'	
[0.6350 0.0780 0.1840]	'#A2142F'	

The software chooses an appropriate text color for cell labels automatically, depending on the color of the chart cells.

Example: `cm = confusionchart(__, 'DiagonalColor', 'blue')`

Example: `cm.DiagonalColor = 'blue'`

**OffDiagonalColor – Color for off-diagonal cells**







`[0.8510 0.3255 0.0980]` (default) | RGB triplet | hexadecimal color code | 'r' | 'g' | 'b' | ...

Color for off-diagonal cells, specified as an RGB triplet, a hexadecimal color code, a color name, or a short name. The color of each diagonal cell is proportional to the cell value and the `OffDiagonalColor` property, normalized to the largest cell value of the confusion matrix chart. Cells with positive values are colored with a minimum amount of color, proportional to the `OffDiagonalColor` property.





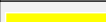

RGB triplets and hexadecimal color codes are useful for specifying custom colors.

- An RGB triplet is a three-element row vector whose elements specify the intensities of the red, green, and blue components of the color. The intensities must be in the range  $[0, 1]$ ; for example,  $[0.4 \ 0.6 \ 0.7]$ .
- A hexadecimal color code is a character vector or a string scalar that starts with a hash symbol (#) followed by three or six hexadecimal digits, which can range from 0 to F. The values are not case sensitive. Thus, the color codes '#FF8800', '#ff8800', '#F80', and '#f80' are equivalent.

Alternatively, you can specify some common colors by name. This table lists the named color options, the equivalent RGB triplets, and hexadecimal color codes.

Color Name	Short Name	RGB Triplet	Hexadecimal Color Code	Appearance
'red'	'r'	[1 0 0]	'#FF0000'	
'green'	'g'	[0 1 0]	'#00FF00'	
'blue'	'b'	[0 0 1]	'#0000FF'	
'cyan'	'c'	[0 1 1]	'#00FFFF'	
'magenta'	'm'	[1 0 1]	'#FF00FF'	
'yellow'	'y'	[1 1 0]	'#FFFF00'	
'black'	'k'	[0 0 0]	'#000000'	
'white'	'w'	[1 1 1]	'#FFFFFF'	

Here are the RGB triplets and hexadecimal color codes for the default colors MATLAB uses in many types of plots.

RGB Triplet	Hexadecimal Color Code	Appearance
[0 0.4470 0.7410]	'#0072BD'	
[0.8500 0.3250 0.0980]	'#D95319'	
[0.9290 0.6940 0.1250]	'#EDB120'	
[0.4940 0.1840 0.5560]	'#7E2F8E'	
[0.4660 0.6740 0.1880]	'#77AC30'	
[0.3010 0.7450 0.9330]	'#4DBEEE'	
[0.6350 0.0780 0.1840]	'#A2142F'	

The software chooses an appropriate text color for cell labels automatically, depending on the color of the chart cells.

Example: `cm = confusionchart(___, 'OffDiagonalColor', 'blue')`

Example: `cm.OffDiagonalColor = 'blue'`

**FontColor** — Text color for title, axis labels, and class labels









[0.1500 0.1500 0.1500] (default) | RGB triplet | hexadecimal color code | 'r' | 'g' | 'b' | ...

Text color for title, axis labels, and class labels, specified as an RGB triplet, a hexadecimal color code, a color name, or a short name.







RGB triplets and hexadecimal color codes are useful for specifying custom colors.

- An RGB triplet is a three-element row vector whose elements specify the intensities of the red, green, and blue components of the color. The intensities must be in the range [0, 1]; for example, [0.4 0.6 0.7].
- A hexadecimal color code is a character vector or a string scalar that starts with a hash symbol (#) followed by three or six hexadecimal digits, which can range from 0 to F. The values are not case sensitive. Thus, the color codes '#FF8800', '#ff8800', '#F80', and '#f80' are equivalent.

Alternatively, you can specify some common colors by name. This table lists the named color options, the equivalent RGB triplets, and hexadecimal color codes.

Color Name	Short Name	RGB Triplet	Hexadecimal Color Code	Appearance
'red'	'r'	[1 0 0]	'#FF0000'	
'green'	'g'	[0 1 0]	'#00FF00'	
'blue'	'b'	[0 0 1]	'#0000FF'	
'cyan'	'c'	[0 1 1]	'#00FFFF'	
'magenta'	'm'	[1 0 1]	'#FF00FF'	
'yellow'	'y'	[1 1 0]	'#FFFF00'	
'black'	'k'	[0 0 0]	'#000000'	
'white'	'w'	[1 1 1]	'#FFFFFF'	

Here are the RGB triplets and hexadecimal color codes for the default colors MATLAB uses in many types of plots.

RGB Triplet	Hexadecimal Color Code	Appearance
[0 0.4470 0.7410]	'#0072BD'	
[0.8500 0.3250 0.0980]	'#D95319'	
[0.9290 0.6940 0.1250]	'#EDB120'	
[0.4940 0.1840 0.5560]	'#7E2F8E'	
[0.4660 0.6740 0.1880]	'#77AC30'	
[0.3010 0.7450 0.9330]	'#4DBEEE'	
[0.6350 0.0780 0.1840]	'#A2142F'	

The software chooses an appropriate text color for cell labels automatically, depending on the color of the chart cells.

Example: `cm = confusionchart(__, 'FontColor', 'blue')`

Example: `cm.FontColor = 'blue'`

**Font****FontName — Font name**

system supported font name

Font name, specified as a system supported font name. The default font depends on the specific operating system and locale.

Example: `cm = confusionchart(__, 'FontName', 'Cambria')`

Example: `cm.FontName = 'Cambria'`

**FontSize — Font size**

positive scalar

Font size used for the title, axis labels, class labels, and cell labels, specified as a positive scalar. The default font depends on the specific operating system and locale.

The title and axis labels use a slightly larger font size (scaled up by 10%). If there is not enough room to display the cell labels within the cells, then the cell labels use a smaller font size. If the cell labels become too small, then they are hidden.

Example: `cm = confusionchart(__, 'FontSize', 12)`

Example: `cm.FontSize = 12`

**Position****PositionConstraint — Position to hold constant**

'outerposition' | 'innerposition'

Position property to hold constant when adding, removing, or changing decorations, specified as one of the following values:

- 'outerposition' — The `OuterPosition` property remains constant when you add, remove, or change decorations such as a title or an axis label. If any positional adjustments are needed, MATLAB adjusts the `InnerPosition` property.
- 'innerposition' — The `InnerPosition` property remains constant when you add, remove, or change decorations such as a title or an axis label. If any positional adjustments are needed, MATLAB adjusts the `OuterPosition` property.

---

**Note** Setting this property has no effect when the parent container is a `TiledChartLayout`.

---

**OuterPosition — Outer size and position**

[0 0 1 1] (default) | four-element vector

Outer size and position within the parent container (a figure, panel, or tab), specified as a four-element vector of the form [left bottom width height]. The outer position includes the title, axis labels, and class labels.

- The `left` and `bottom` elements define the distance from the lower left corner of the container to the lower left corner of the chart.
- The `width` and `height` elements are the chart dimensions, which include the chart cells, plus a margin for the surrounding text.

The default value of `[0 0 1 1]` is the whole interior of the container.

By default, the values are normalized to the container. To change the units, set the `Units` property.

Example: `cm = confusionchart(__, 'OuterPosition', [0.1 0.1 0.8 0.8])`

Example: `cm.OuterPosition = [0.1 0.1 0.8 0.8]`

**InnerPosition — Inner size and position**

`[0.1300 0.1100 0.7750 0.8150]` (default) | four-element vector

Inner size and position of the chart within the parent container (a figure, panel, or tab) returned as a four-element vector of the form `[left bottom width height]`. The inner position does not include the title, axis labels, or class labels.

- The `left` and `bottom` elements define the distance from the lower left corner of the container to the lower left corner of the chart.
- The `width` and `height` elements are the chart dimensions, which include only the chart cells.

Example: `cm = confusionchart(__, 'InnerPosition', [0.1 0.1 0.8 0.8])`

Example: `cm.InnerPosition = [0.1 0.1 0.8 0.8]`

**Position — Inner size and position**

four-element vector

Inner size and position of the chart within the parent container (a figure, panel, or tab) returned as a four-element vector of the form `[left bottom width height]`. This property is equivalent to the `InnerPosition` property.

**Units — Position units**

'normalized' (default) | 'inches' | 'centimeters' | 'points' | 'pixels' | 'characters'

Position units, specified as one of these values:

Units	Description
'normalized'	Normalized with respect to the container, which is typically the figure or a panel. The lower left corner of the container maps to $(0, 0)$ , and the upper right corner maps to $(1, 1)$ .
'inches'	Inches.
'centimeters'	Centimeters.
'characters'	Based on the default uicontrol font of the graphics root object: <ul style="list-style-type: none"> <li>• Character width = width of letter x.</li> <li>• Character height = distance between the baselines of two lines of text.</li> </ul>
'points'	Typography points. One point equals 1/72 inch.

Units	Description
'pixels'	Pixels.  Starting in R2015b, distances in pixels are independent of your system resolution on Windows® and Macintosh systems: <ul style="list-style-type: none"> <li>• On Windows systems, a pixel is 1/96th of an inch.</li> <li>• On Macintosh systems, a pixel is 1/72nd of an inch.</li> </ul> On Linux® systems, the size of a pixel is determined by your system resolution.

When specifying the units as a name-value pair during object creation, you must set the `Units` property before specifying the properties that you want to use these units for, such as `OuterPosition`.

### Visible — State of visibility

'on' (default) | on/off logical value

State of visibility, specified as 'on' or 'off', or as numeric or logical 1 (true) or 0 (false). A value of 'on' is equivalent to true, and 'off' is equivalent to false. Thus, you can use the value of this property as a logical value. The value is stored as an on/off logical value of type `matlab.lang.OnOffSwitchState`.

- 'on' — Display the chart.
- 'off' — Hide the chart without deleting it. You still can access the properties of an invisible chart.

### Parent/Child

#### Parent — Parent container

figure object | panel object | tab object

Parent container, specified as a figure, panel, or tab object.

#### HandleVisibility — Visibility of object handle

'on' (default) | 'off' | 'callback'

Visibility of the chart object handle in the `Children` property of the parent, specified as one of these values:

- 'on' — Object handle is always visible.
- 'off' — Object handle is invisible at all times. This option is useful for preventing unintended changes to the UI by another function. To temporarily hide the handle during the execution of that function, set the `HandleVisibility` to 'off'.
- 'callback' — Object handle is visible from within callbacks or functions invoked by callbacks, but not from within functions invoked from the command line. This option blocks access to the object at the command line, but allows callback functions to access it.

If the object is not listed in the `Children` property of the parent, then functions that obtain object handles by searching the object hierarchy or querying handle properties cannot return it. This includes `get`, `findobj`, `gca`, `gcf`, `gco`, `newplot`, `cla`, `clf`, and `close`.

Hidden object handles are still valid. Set the root `ShowHiddenHandles` property to `'on'` to list all object handles, regardless of their `HandleVisibility` property setting.

## See Also

### Functions

`categorical` | `confusionchart` | `sortClasses`

### Topics

“Deep Learning in MATLAB”

**Introduced in R2018b**



# connectLayers

Connect layers in layer graph

## Syntax

```
newlgraph = connectLayers(lgraph,s,d)
```

## Description

`newlgraph = connectLayers(lgraph,s,d)` connects the source layer `s` to the destination layer `d` in the layer graph `lgraph`. The new layer graph, `newlgraph`, contains the same layers as `lgraph` and includes the new connection.

## Examples

### Create and Connect Addition Layer

Create an addition layer with two inputs and the name 'add\_1'.

```
add = additionLayer(2,'Name','add_1')
```

```
add =  
    AdditionLayer with properties:
```

```
        Name: 'add_1'  
    NumInputs: 2  
    InputNames: {'in1' 'in2'}
```

Create two ReLU layers and connect them to the addition layer. The addition layer sums the outputs from the ReLU layers.

```
relu_1 = reluLayer('Name','relu_1');  
relu_2 = reluLayer('Name','relu_2');
```

```
lgraph = layerGraph;  
lgraph = addLayers(lgraph,relu_1);  
lgraph = addLayers(lgraph,relu_2);  
lgraph = addLayers(lgraph,add);
```

```
lgraph = connectLayers(lgraph,'relu_1','add_1/in1');  
lgraph = connectLayers(lgraph,'relu_2','add_1/in2');
```

```
plot(lgraph)
```

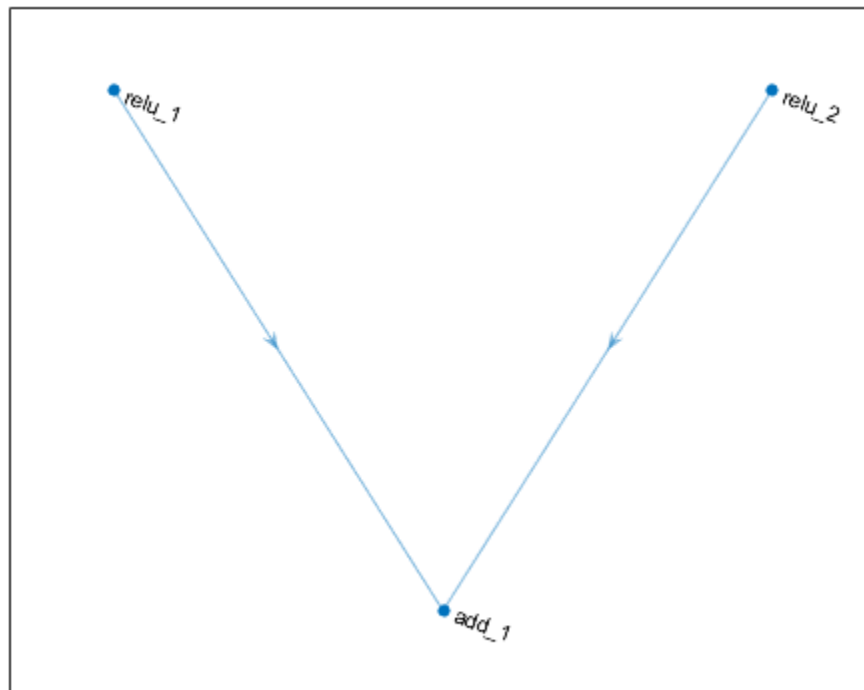

### Create Simple DAG Network

Create a simple directed acyclic graph (DAG) network for deep learning. Train the network to classify images of digits. The simple network in this example consists of:

- A main branch with layers connected sequentially.
- A *shortcut connection* containing a single 1-by-1 convolutional layer. Shortcut connections enable the parameter gradients to flow more easily from the output layer to the earlier layers of the network.

Create the main branch of the network as a layer array. The addition layer sums multiple inputs element-wise. Specify the number of inputs for the addition layer to sum. All layers must have names and all names must be unique.

```

layers = [
    imageInputLayer([28 28 1], 'Name', 'input')

    convolution2dLayer(5,16, 'Padding', 'same', 'Name', 'conv_1')
    batchNormalizationLayer('Name', 'BN_1')
    reluLayer('Name', 'relu_1')

    convolution2dLayer(3,32, 'Padding', 'same', 'Stride', 2, 'Name', 'conv_2')
    batchNormalizationLayer('Name', 'BN_2')
    reluLayer('Name', 'relu_2')
  
```

```

convolution2dLayer(3,32,'Padding','same','Name','conv_3')
batchNormalizationLayer('Name','BN_3')
reluLayer('Name','relu_3')

additionLayer(2,'Name','add')

averagePooling2dLayer(2,'Stride',2,'Name','avpool')
fullyConnectedLayer(10,'Name','fc')
softmaxLayer('Name','softmax')
classificationLayer('Name','classOutput']);

```

Create a layer graph from the layer array. `layerGraph` connects all the layers in `layers` sequentially. Plot the layer graph.

```

lgraph = layerGraph(layers);
figure
plot(lgraph)

```

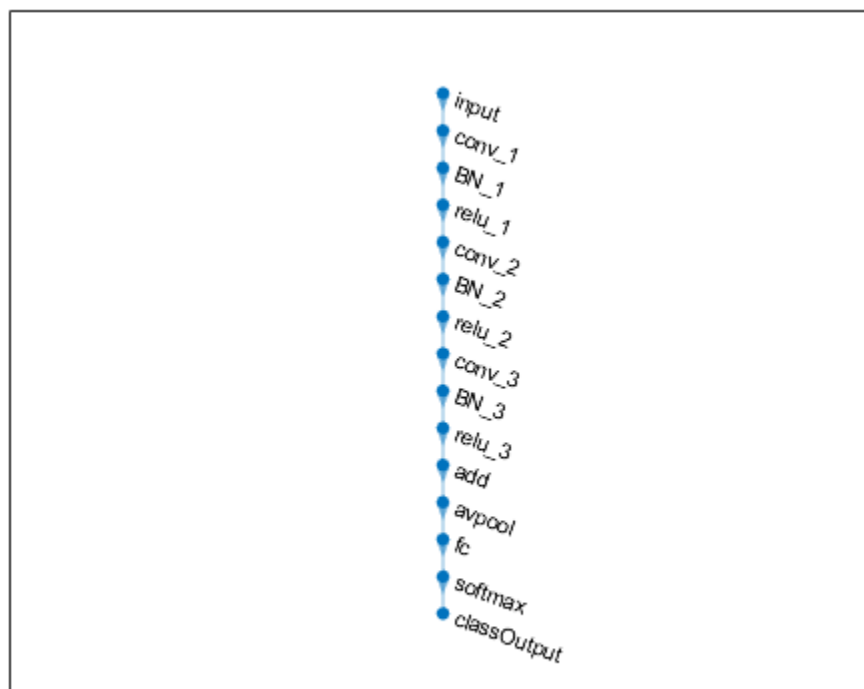

Create the 1-by-1 convolutional layer and add it to the layer graph. Specify the number of convolutional filters and the stride so that the activation size matches the activation size of the 'relu\_3' layer. This arrangement enables the addition layer to add the outputs of the 'skipConv' and 'relu\_3' layers. To check that the layer is in the graph, plot the layer graph.

```

skipConv = convolution2dLayer(1,32,'Stride',2,'Name','skipConv');
lgraph = addLayers(lgraph,skipConv);
figure
plot(lgraph)

```

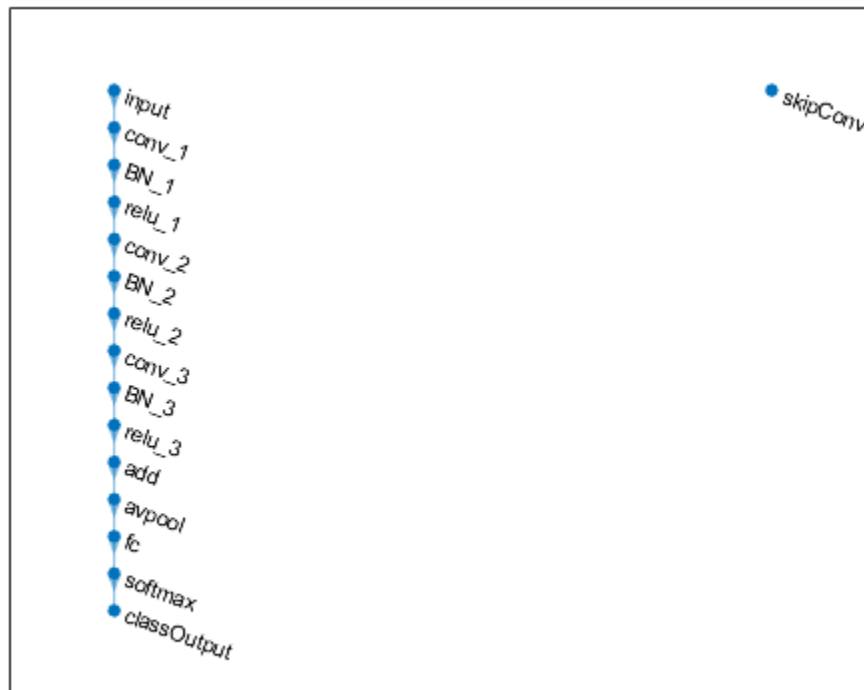

Create the shortcut connection from the 'relu\_1' layer to the 'add' layer. Because you specified two as the number of inputs to the addition layer when you created it, the layer has two inputs named 'in1' and 'in2'. The 'relu\_3' layer is already connected to the 'in1' input. Connect the 'relu\_1' layer to the 'skipConv' layer and the 'skipConv' layer to the 'in2' input of the 'add' layer. The addition layer now sums the outputs of the 'relu\_3' and 'skipConv' layers. To check that the layers are connected correctly, plot the layer graph.

```
lgraph = connectLayers(lgraph, 'relu_1', 'skipConv');  
lgraph = connectLayers(lgraph, 'skipConv', 'add/in2');  
figure  
plot(lgraph);
```

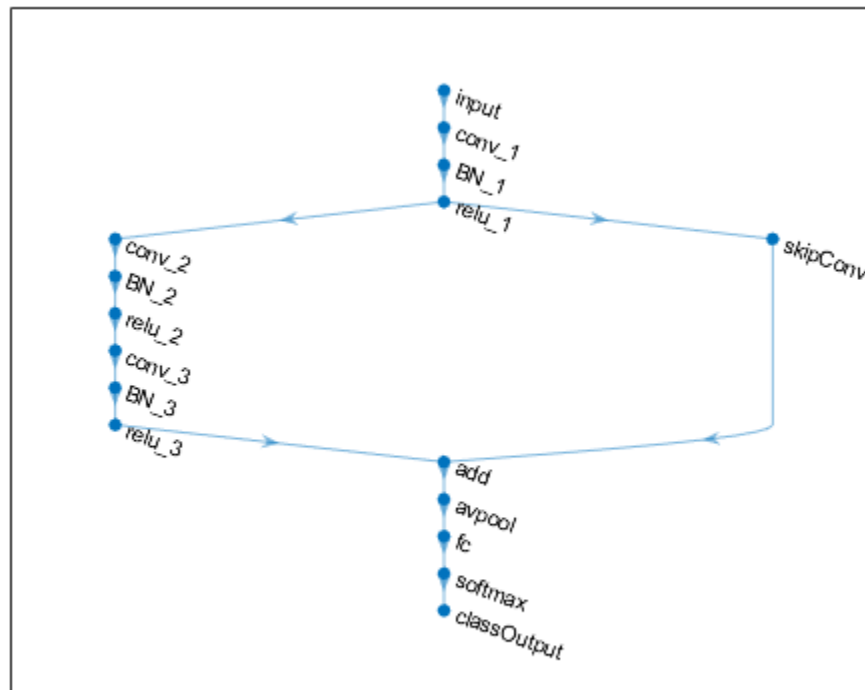

Load the training and validation data, which consists of 28-by-28 grayscale images of digits.

```
[XTrain,YTrain] = digitTrain4DArrayData;
[XValidation,YValidation] = digitTest4DArrayData;
```

Specify training options and train the network. `trainNetwork` validates the network using the validation data every `ValidationFrequency` iterations.

```
options = trainingOptions('sgdm', ...
    'MaxEpochs',8, ...
    'Shuffle','every-epoch', ...
    'ValidationData',{XValidation,YValidation}, ...
    'ValidationFrequency',30, ...
    'Verbose',false, ...
    'Plots','training-progress');
net = trainNetwork(XTrain,YTrain,lgraph,options);
```

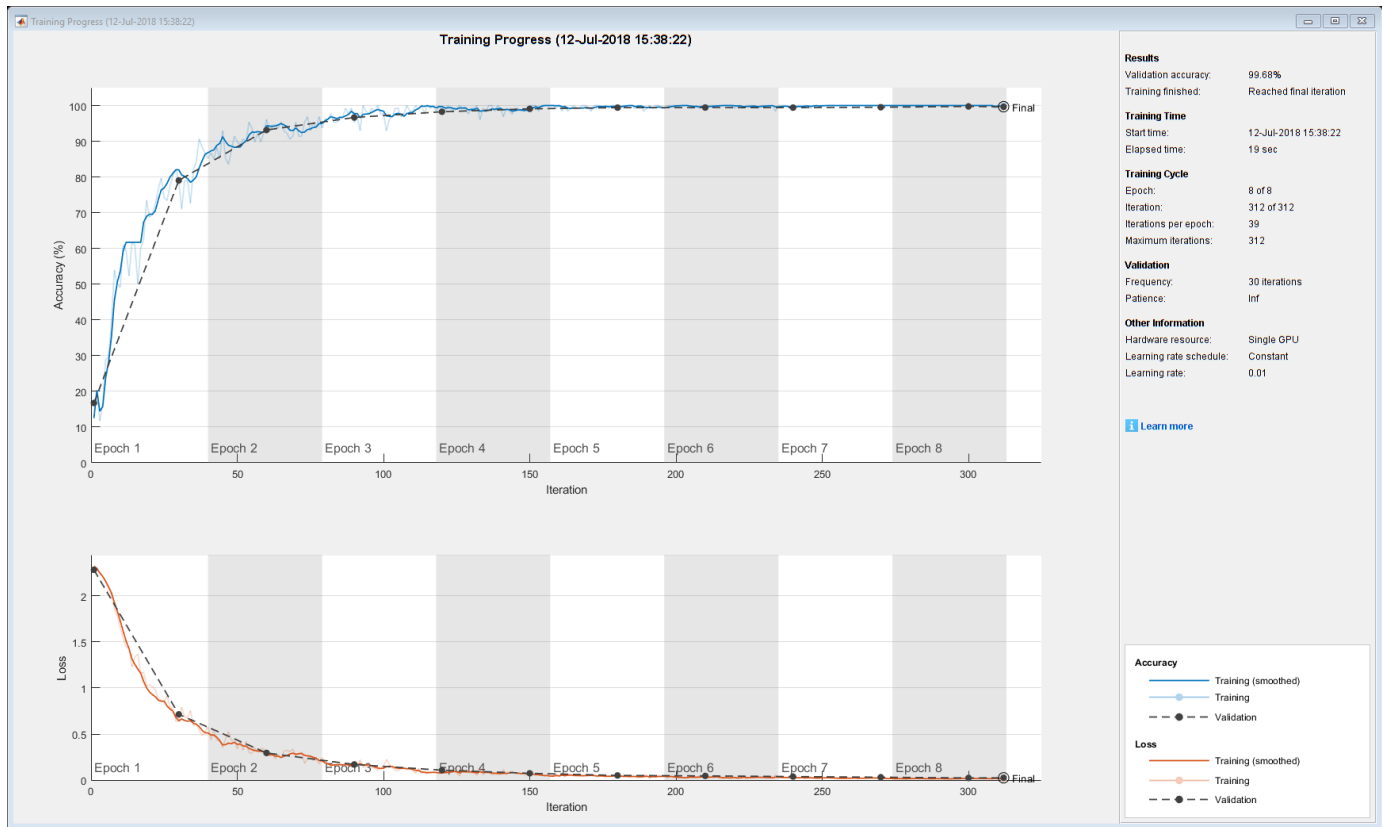

Display the properties of the trained network. The network is a DAGNetwork object.

```
net
```

```
net =
```

```
DAGNetwork with properties:
```

```
Layers: [16x1 nnet.cnn.layer.Layer]
```

```
Connections: [16x2 table]
```

Classify the validation images and calculate the accuracy. The network is very accurate.

```
YPredicted = classify(net,XValidation);  
accuracy = mean(YPredicted == YValidation)
```

```
accuracy = 0.9968
```

## Input Arguments

**lgraph** — Layer graph

LayerGraph object

Layer graph, specified as a LayerGraph object. To create a layer graph, use `layerGraph`.

**s** — Connection source

character vector | string scalar

Connection source, specified as a character vector or a string scalar.

- If the source layer has a single output, then `s` is the name of the layer.
- If the source layer has multiple outputs, then `s` is the layer name followed by the character `/` and the name of the layer output: `'layerName/outputName'`.

Example: `'conv1'`

Example: `'mpool/indices'`

### **d** — Connection destination

character vector | string scalar

Connection destination, specified as a character vector or a string scalar.

- If the destination layer has a single input, then `d` is the name of the layer.
- If the destination layer has multiple inputs, then `d` is the layer name followed by the character `/` and the name of the layer input: `'layerName/inputName'`.

Example: `'fc'`

Example: `'addlayer1/in2'`

## **Output Arguments**

### **newlgraph** — Output layer graph

LayerGraph object

Output layer graph, returned as a LayerGraph object.

## **See Also**

`addLayers` | `assembleNetwork` | `disconnectLayers` | `layerGraph` | `plot` | `removeLayers` | `replaceLayer`

## **Topics**

“Train Residual Network for Image Classification”

“Train Deep Learning Network to Classify New Images”

## **Introduced in R2017b**

# convolution2dLayer

2-D convolutional layer

## Description

A 2-D convolutional layer applies sliding convolutional filters to the input. The layer convolves the input by moving the filters along the input vertically and horizontally and computing the dot product of the weights and the input, and then adding a bias term.

## Creation

### Syntax

```
layer = convolution2dLayer(filterSize,numFilters)
layer = convolution2dLayer(filterSize,numFilters,Name,Value)
```

### Description

`layer = convolution2dLayer(filterSize,numFilters)` creates a 2-D convolutional layer and sets the `FilterSize` and `NumFilters` properties.

`layer = convolution2dLayer(filterSize,numFilters,Name,Value)` sets the optional `Stride`, `DilationFactor`, `NumChannels`, “Parameters and Initialization” on page 1-217, “Learn Rate and Regularization” on page 1-218, and `Name` properties using name-value pairs. To specify input padding, use the 'Padding' name-value pair argument. For example, `convolution2dLayer(11,96,'Stride',4,'Padding',1)` creates a 2-D convolutional layer with 96 filters of size [11 11], a stride of [4 4], and zero padding of size 1 along all edges of the layer input. You can specify multiple name-value pairs. Enclose each property name in single quotes.

### Input Arguments

#### Name-Value Pair Arguments

Use comma-separated name-value pair arguments to specify the size of the zero padding to add along the edges of the layer input or to set the `Stride`, `DilationFactor`, `NumChannels`, “Parameters and Initialization” on page 1-217, “Learn Rate and Regularization” on page 1-218, and `Name` properties. Enclose names in single quotes.

Example: `convolution2dLayer(3,16,'Padding','same')` creates a 2-D convolutional layer with 16 filters of size [3 3] and 'same' padding. At training time, the software calculates and sets the size of the zero padding so that the layer output has the same size as the input.

#### Padding — Input edge padding

[0 0 0 0] (default) | vector of nonnegative integers | 'same'

Input edge padding, specified as the comma-separated pair consisting of 'Padding' and one of these values:



- 'same' — Add padding of size calculated by the software at training or prediction time so that the output has the same size as the input when the stride equals 1. If the stride is larger than 1, then the output size is  $\text{ceil}(\text{inputSize}/\text{stride})$ , where `inputSize` is the height or width of the input and `stride` is the stride in the corresponding dimension. The software adds the same amount of padding to the top and bottom, and to the left and right, if possible. If the padding that must be added vertically has an odd value, then the software adds extra padding to the bottom. If the padding that must be added horizontally has an odd value, then the software adds extra padding to the right.
- Nonnegative integer `p` — Add padding of size `p` to all the edges of the input.
- Vector `[a b]` of nonnegative integers — Add padding of size `a` to the top and bottom of the input and padding of size `b` to the left and right.
- Vector `[t b l r]` of nonnegative integers — Add padding of size `t` to the top, `b` to the bottom, `l` to the left, and `r` to the right of the input.

Example: 'Padding', 1 adds one row of padding to the top and bottom, and one column of padding to the left and right of the input.

Example: 'Padding', 'same' adds padding so that the output has the same size as the input (if the stride equals 1).

## Properties

### Convolution

#### FilterSize — Height and width of filters

vector of two positive integers

Height and width of the filters, specified as a vector `[h w]` of two positive integers, where `h` is the height and `w` is the width. `FilterSize` defines the size of the local regions to which the neurons connect in the input.

When creating the layer, you can specify `FilterSize` as a scalar to use the same value for the height and width.

Example: `[5 5]` specifies filters with a height of 5 and a width of 5.

#### NumFilters — Number of filters

positive integer

Number of filters, specified as a positive integer. This number corresponds to the number of neurons in the convolutional layer that connect to the same region in the input. This parameter determines the number of channels (feature maps) in the output of the convolutional layer.

Example: 96

#### Stride — Step size for traversing input

`[1 1]` (default) | vector of two positive integers

Step size for traversing the input vertically and horizontally, specified as a vector `[a b]` of two positive integers, where `a` is the vertical step size and `b` is the horizontal step size. When creating the layer, you can specify `Stride` as a scalar to use the same value for both step sizes.

Example: `[2 3]` specifies a vertical step size of 2 and a horizontal step size of 3.

**DilationFactor — Factor for dilated convolution**

[1 1] (default) | vector of two positive integers

Factor for dilated convolution (also known as atrous convolution), specified as a vector [h w] of two positive integers, where h is the vertical dilation and w is the horizontal dilation. When creating the layer, you can specify `DilationFactor` as a scalar to use the same value for both horizontal and vertical dilations.

Use dilated convolutions to increase the receptive field (the area of the input which the layer can see) of the layer without increasing the number of parameters or computation.

The layer expands the filters by inserting zeros between each filter element. The dilation factor determines the step size for sampling the input or equivalently the upsampling factor of the filter. It corresponds to an effective filter size of  $(Filter\ Size - 1) * Dilation\ Factor + 1$ . For example, a 3-by-3 filter with the dilation factor [2 2] is equivalent to a 5-by-5 filter with zeros between the elements.

Example: [2 3]

**PaddingSize — Size of padding**

[0 0 0 0] (default) | vector of four nonnegative integers

Size of padding to apply to input borders, specified as a vector [t b l r] of four nonnegative integers, where t is the padding applied to the top, b is the padding applied to the bottom, l is the padding applied to the left, and r is the padding applied to the right.

When you create a layer, use the 'Padding' name-value pair argument to specify the padding size.

Example: [1 1 2 2] adds one row of padding to the top and bottom, and two columns of padding to the left and right of the input.

**PaddingMode — Method to determine padding size**

'manual' (default) | 'same'

Method to determine padding size, specified as 'manual' or 'same'.

The software automatically sets the value of `PaddingMode` based on the 'Padding' value you specify when creating a layer.

- If you set the 'Padding' option to a scalar or a vector of nonnegative integers, then the software automatically sets `PaddingMode` to 'manual'.
- If you set the 'Padding' option to 'same', then the software automatically sets `PaddingMode` to 'same' and calculates the size of the padding at training time so that the output has the same size as the input when the stride equals 1. If the stride is larger than 1, then the output size is  $\text{ceil}(\text{inputSize}/\text{stride})$ , where `inputSize` is the height or width of the input and `stride` is the stride in the corresponding dimension. The software adds the same amount of padding to the top and bottom, and to the left and right, if possible. If the padding that must be added vertically has an odd value, then the software adds extra padding to the bottom. If the padding that must be added horizontally has an odd value, then the software adds extra padding to the right.

**Padding — Size of padding**

[0 0] (default) | vector of two nonnegative integers

---

**Note** `Padding` property will be removed in a future release. Use `PaddingSize` instead. When creating a layer, use the 'Padding' name-value pair argument to specify the padding size.

---

Size of padding to apply to input borders vertically and horizontally, specified as a vector [a b] of two nonnegative integers, where a is the padding applied to the top and bottom of the input data and b is the padding applied to the left and right.

Example: [1 1] adds one row of padding to the top and bottom, and one column of padding to the left and right of the input.

### **NumChannels — Number of channels for each filter**

'auto' (default) | positive integer

Number of channels for each filter, specified as 'auto' or a positive integer.

This parameter is always equal to the number of channels of the input to the convolutional layer. For example, if the input is a color image, then the number of channels for the input is 3. If the number of filters for the convolutional layer prior to the current layer is 16, then the number of channels for the current layer is 16.

If NumChannels is 'auto', then the software determines the number of channels at training time.

Example: 256

### **Parameters and Initialization**

#### **WeightsInitializer — Function to initialize weights**

'glorot' (default) | 'he' | 'narrow-normal' | 'zeros' | 'ones' | function handle

Function to initialize the weights, specified as one of the following:

- 'glorot' - Initialize the weights with the Glorot initializer [4] (also known as Xavier initializer). The Glorot initializer independently samples from a uniform distribution with zero mean and variance  $2/(\text{numIn} + \text{numOut})$ , where  $\text{numIn} = \text{FilterSize}(1) * \text{FilterSize}(2) * \text{NumChannels}$  and  $\text{numOut} = \text{FilterSize}(1) * \text{FilterSize}(2) * \text{NumFilters}$ .
- 'he' - Initialize the weights with the He initializer [5]. The He initializer samples from a normal distribution with zero mean and variance  $2/\text{numIn}$ , where  $\text{numIn} = \text{FilterSize}(1) * \text{FilterSize}(2) * \text{NumChannels}$ .
- 'narrow-normal' - Initialize the weights by independently sampling from a normal distribution with zero mean and standard deviation 0.01.
- 'zeros' - Initialize the weights with zeros.
- 'ones' - Initialize the weights with ones.
- Function handle - Initialize the weights with a custom function. If you specify a function handle, then the function must be of the form `weights = func(sz)`, where `sz` is the size of the weights. For an example, see "Specify Custom Weight Initialization Function".

The layer only initializes the weights when the `Weights` property is empty.

Data Types: char | string | function\_handle

#### **BiasInitializer — Function to initialize bias**

'zeros' (default) | 'narrow-normal' | 'ones' | function handle

Function to initialize the bias, specified as one of the following:

- 'zeros' - Initialize the bias with zeros.

- 'ones' - Initialize the bias with ones.
- 'narrow-normal' - Initialize the bias by independently sampling from a normal distribution with zero mean and standard deviation 0.01.
- Function handle - Initialize the bias with a custom function. If you specify a function handle, then the function must be of the form `bias = func(sz)`, where `sz` is the size of the bias.

The layer only initializes the bias when the `Bias` property is empty.

Data Types: `char` | `string` | `function_handle`

### **Weights — Layer weights**

`[]` (default) | numeric array

Layer weights for the convolutional layer, specified as a numeric array.

The layer weights are learnable parameters. You can specify the initial value for the weights directly using the `Weights` property of the layer. When training a network, if the `Weights` property of the layer is nonempty, then `trainNetwork` uses the `Weights` property as the initial value. If the `Weights` property is empty, then `trainNetwork` uses the initializer specified by the `WeightsInitializer` property of the layer.

At training time, `Weights` is a `FilterSize(1)`-by-`FilterSize(2)`-by-`NumChannels`-by-`NumFilters` array.

Data Types: `single` | `double`

### **Bias — Layer biases**

`[]` (default) | numeric array

Layer biases for the convolutional layer, specified as a numeric array.

The layer biases are learnable parameters. When training a network, if `Bias` is nonempty, then `trainNetwork` uses the `Bias` property as the initial value. If `Bias` is empty, then `trainNetwork` uses the initializer specified by `BiasInitializer`.

At training time, `Bias` is a 1-by-1-by-`NumFilters` array.

Data Types: `single` | `double`

### **Learn Rate and Regularization**

#### **WeightLearnRateFactor — Learning rate factor for weights**

1 (default) | nonnegative scalar

Learning rate factor for the weights, specified as a nonnegative scalar.

The software multiplies this factor by the global learning rate to determine the learning rate for the weights in this layer. For example, if `WeightLearnRateFactor` is 2, then the learning rate for the weights in this layer is twice the current global learning rate. The software determines the global learning rate based on the settings specified with the `trainingOptions` function.

Example: 2

#### **BiasLearnRateFactor — Learning rate factor for biases**

1 (default) | nonnegative scalar

Learning rate factor for the biases, specified as a nonnegative scalar.

The software multiplies this factor by the global learning rate to determine the learning rate for the biases in this layer. For example, if `BiasLearnRateFactor` is 2, then the learning rate for the biases in the layer is twice the current global learning rate. The software determines the global learning rate based on the settings specified with the `trainingOptions` function.

Example: 2

### **WeightL2Factor — L2 regularization factor for weights**

1 (default) | nonnegative scalar

L2 regularization factor for the weights, specified as a nonnegative scalar.

The software multiplies this factor by the global L2 regularization factor to determine the L2 regularization for the weights in this layer. For example, if `WeightL2Factor` is 2, then the L2 regularization for the weights in this layer is twice the global L2 regularization factor. You can specify the global L2 regularization factor using the `trainingOptions` function.

Example: 2

### **BiasL2Factor — L2 regularization factor for biases**

0 (default) | nonnegative scalar

L2 regularization factor for the biases, specified as a nonnegative scalar.

The software multiplies this factor by the global L2 regularization factor to determine the L2 regularization for the biases in this layer. For example, if `BiasL2Factor` is 2, then the L2 regularization for the biases in this layer is twice the global L2 regularization factor. You can specify the global L2 regularization factor using the `trainingOptions` function.

Example: 2

## **Layer**

### **Name — Layer name**

' ' (default) | character vector | string scalar

Layer name, specified as a character vector or a string scalar. To include a layer in a layer graph, you must specify a nonempty unique layer name. If you train a series network with the layer and `Name` is set to ' ', then the software automatically assigns a name to the layer at training time.

Data Types: `char` | `string`

### **NumInputs — Number of inputs**

1 (default)

Number of inputs of the layer. This layer accepts a single input only.

Data Types: `double`

### **InputNames — Input names**

{ 'in' } (default)

Input names of the layer. This layer accepts a single input only.

Data Types: `cell`

**NumOutputs — Number of outputs**

1 (default)

Number of outputs of the layer. This layer has a single output only.

Data Types: double

**OutputNames — Output names**

{'out'} (default)

Output names of the layer. This layer has a single output only.

Data Types: cell

**Examples****Create Convolutional Layer**

Create a convolutional layer with 96 filters, each with a height and width of 11. Use a stride (step size) of 4 in the horizontal and vertical directions.

```
layer = convolution2dLayer(11,96,'Stride',4)
```

```
layer =  
Convolution2DLayer with properties:
```

```
    Name: ''
```

```
Hyperparameters
```

```
    FilterSize: [11 11]
```

```
    NumChannels: 'auto'
```

```
    NumFilters: 96
```

```
    Stride: [4 4]
```

```
    DilationFactor: [1 1]
```

```
    PaddingMode: 'manual'
```

```
    PaddingSize: [0 0 0 0]
```

```
Learnable Parameters
```

```
    Weights: []
```

```
    Bias: []
```

```
Show all properties
```

Include a convolutional layer in a Layer array.

```
layers = [  
    imageInputLayer([28 28 1])  
    convolution2dLayer(5,20)  
    reluLayer  
    maxPooling2dLayer(2,'Stride',2)  
    fullyConnectedLayer(10)  
    softmaxLayer  
    classificationLayer]
```

```
layers =  
7x1 Layer array with layers:
```

```

1 '' Image Input          28x28x1 images with 'zerocenter' normalization
2 '' Convolution         20 5x5 convolutions with stride [1 1] and padding [0 0 0]
3 '' ReLU                ReLU
4 '' Max Pooling         2x2 max pooling with stride [2 2] and padding [0 0 0 0]
5 '' Fully Connected    10 fully connected layer
6 '' Softmax             softmax
7 '' Classification Output crossentropyex

```

### Specify Initial Weights and Biases in Convolutional Layer

To specify the weights and bias initializer functions, use the `WeightsInitializer` and `BiasInitializer` properties respectively. To specify the weights and biases directly, use the `Weights` and `Bias` properties respectively.

### Specify Initialization Functions

Create a convolutional layer with 32 filters, each with a height and width of 5 and specify the weights initializer to be the He initializer.

```

filterSize = 5;
numFilters = 32;
layer = convolution2dLayer(filterSize,numFilters, ...
    'WeightsInitializer','he')

```

```

layer =
    Convolution2DLayer with properties:

```

```

        Name: ''

Hyperparameters
    FilterSize: [5 5]
    NumChannels: 'auto'
    NumFilters: 32
    Stride: [1 1]
DilationFactor: [1 1]
    PaddingMode: 'manual'
    PaddingSize: [0 0 0 0]

Learnable Parameters
    Weights: []
    Bias: []

```

```
Show all properties
```

Note that the `Weights` and `Bias` properties are empty. At training time, the software initializes these properties using the specified initialization functions.

### Specify Custom Initialization Functions

To specify your own initialization function for the weights and biases, set the `WeightsInitializer` and `BiasInitializer` properties to a function handle. For these properties, specify function handles that take the size of the weights and biases as input and output the initialized value.

Create a convolutional layer with 32 filters, each with a height and width of 5 and specify initializers that sample the weights and biases from a Gaussian distribution with a standard deviation of 0.0001.

```
filterSize = 5;
numFilters = 32;

layer = convolution2dLayer(filterSize,numFilters, ...
    'WeightsInitializer', @(sz) rand(sz) * 0.0001, ...
    'BiasInitializer', @(sz) rand(sz) * 0.0001)
```

```
layer =
    Convolution2DLayer with properties:
```

```
        Name: ''
```

```
Hyperparameters
```

```
    FilterSize: [5 5]
    NumChannels: 'auto'
    NumFilters: 32
    Stride: [1 1]
    DilationFactor: [1 1]
    PaddingMode: 'manual'
    PaddingSize: [0 0 0 0]
```

```
Learnable Parameters
```

```
    Weights: []
    Bias: []
```

```
Show all properties
```

Again, the `Weights` and `Bias` properties are empty. At training time, the software initializes these properties using the specified initialization functions.

### Specify Weights and Bias Directly

Create a fully connected layer with an output size of 10 and set the weights and bias to `W` and `b` in the MAT file `Conv2dWeights.mat` respectively.

```
filterSize = 5;
numFilters = 32;
load Conv2dWeights

layer = convolution2dLayer(filterSize,numFilters, ...
    'Weights',W, ...
    'Bias',b)
```

```
layer =
    Convolution2DLayer with properties:
```

```
        Name: ''
```

```
Hyperparameters
```

```
    FilterSize: [5 5]
    NumChannels: 3
    NumFilters: 32
    Stride: [1 1]
    DilationFactor: [1 1]
```



```

    PaddingMode: 'manual'
    PaddingSize: [0 0 0 0]

    Learnable Parameters
      Weights: [5x5x3x32 double]
      Bias: [1x1x32 double]

    Show all properties

```

Here, the `Weights` and `Bias` properties contain the specified values. At training time, if these properties are non-empty, then the software uses the specified values as the initial weights and biases. In this case, the software does not use the initializer functions.

### Create Convolutional Layer That Fully Covers Input

Suppose the size of the input is 28-by-28-by-1. Create a convolutional layer with 16 filters, each with a height of 6 and a width of 4. Set the horizontal and vertical stride to 4.

Make sure the convolution covers the input completely. For the convolution to fully cover the input, both the horizontal and vertical output dimensions must be integer numbers. For the horizontal output dimension to be an integer, one row of zero padding is required on the top and bottom of the image:  $(28 - 6 + 2 * 1)/4 + 1 = 7$ . For the vertical output dimension to be an integer, no zero padding is required:  $(28 - 4 + 2 * 0)/4 + 1 = 7$ .

Construct the convolutional layer.

```
layer = convolution2dLayer([6 4],16,'Stride',4,'Padding',[1 0])
```

```
layer =
    Convolution2DLayer with properties:
```

```

        Name: ''

    Hyperparameters
      FilterSize: [6 4]
      NumChannels: 'auto'
      NumFilters: 16
      Stride: [4 4]
      DilationFactor: [1 1]
      PaddingMode: 'manual'
      PaddingSize: [1 1 0 0]

    Learnable Parameters
      Weights: []
      Bias: []

```

```
Show all properties
```

## More About

### Convolutional Layer

A 2-D convolutional layer applies sliding convolutional filters to the input. The layer convolves the input by moving the filters along the input vertically and horizontally, computing the dot product of the weights and the input, and then adding a bias term.

The convolutional layer consists of various components.<sup>1</sup>

#### Filters and Stride

A convolutional layer consists of neurons that connect to subregions of the input images or the outputs of the previous layer. The layer learns the features localized by these regions while scanning through an image. When creating a layer using the `convolution2dLayer` function, you can specify the size of these regions using the `filterSize` input argument.

For each region, the `trainNetwork` function computes a dot product of the weights and the input, and then adds a bias term. A set of weights that is applied to a region in the image is called a *filter*. The filter moves along the input image vertically and horizontally, repeating the same computation for each region. In other words, the filter convolves the input.

This image shows a 3-by-3 filter scanning through the input. The lower map represents the input and the upper map represents the output.

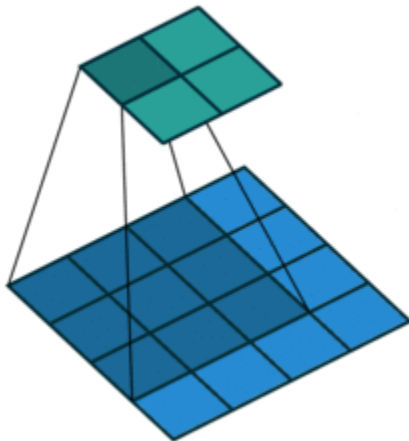

The step size with which the filter moves is called a *stride*. You can specify the step size with the `Stride` name-value pair argument. The local regions that the neurons connect to can overlap depending on the `filterSize` and 'Stride' values.

This image shows a 3-by-3 filter scanning through the input with a stride of 2. The lower map represents the input and the upper map represents the output.

---

1. Image credit: Convolution arithmetic (License)

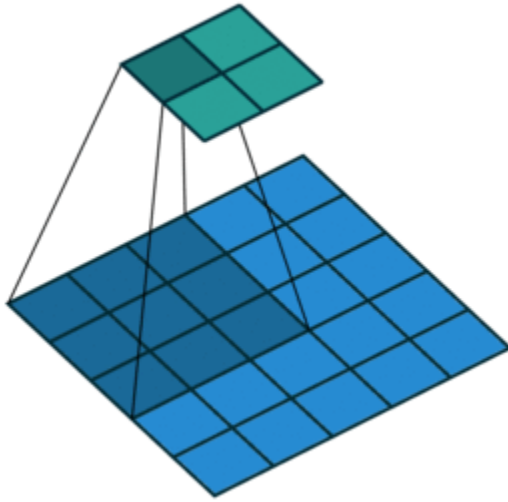

The number of weights in a filter is  $h * w * c$ , where  $h$  is the height, and  $w$  is the width of the filter, respectively, and  $c$  is the number of channels in the input. For example, if the input is a color image, the number of color channels is 3. The number of filters determines the number of channels in the output of a convolutional layer. Specify the number of filters using the `numFilters` argument with the `convolution2dLayer` function.

### Dilated Convolutions

A dilated convolution is a convolution in which the filters are expanded by spaces inserted between the elements of the filter. Specify the dilation factor using the `'DilationFactor'` property.

Use dilated convolutions to increase the receptive field (the area of the input which the layer can see) of the layer without increasing the number of parameters or computation.

The layer expands the filters by inserting zeros between each filter element. The dilation factor determines the step size for sampling the input or equivalently the upsampling factor of the filter. It corresponds to an effective filter size of  $(Filter\ Size - 1) * Dilation\ Factor + 1$ . For example, a 3-by-3 filter with the dilation factor `[2 2]` is equivalent to a 5-by-5 filter with zeros between the elements.

This image shows a 3-by-3 filter dilated by a factor of two scanning through the input. The lower map represents the input and the upper map represents the output.

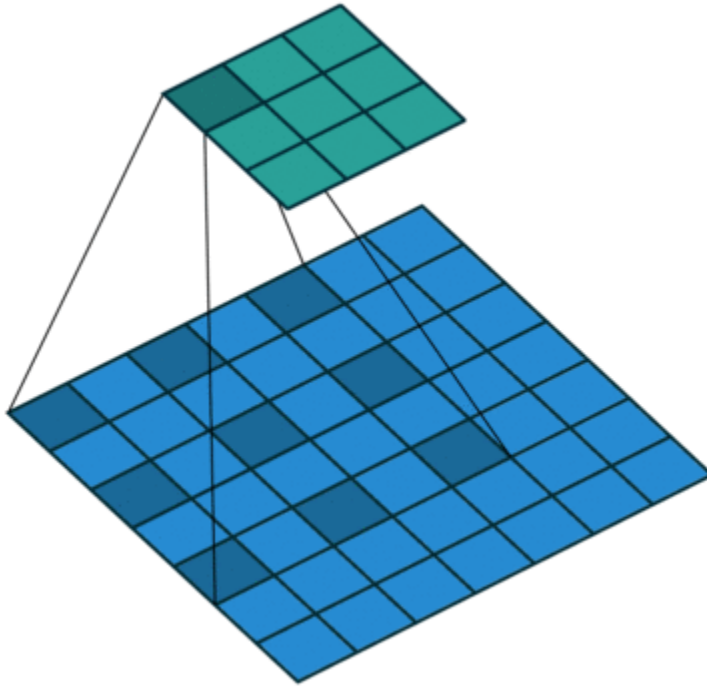

### Feature Maps

As a filter moves along the input, it uses the same set of weights and the same bias for the convolution, forming a *feature map*. Each feature map is the result of a convolution using a different set of weights and a different bias. Hence, the number of feature maps is equal to the number of filters. The total number of parameters in a convolutional layer is  $((h*w*c + 1)*\text{Number of Filters})$ , where 1 is the bias.

### Zero Padding

You can also apply zero padding to input image borders vertically and horizontally using the 'Padding' name-value pair argument. Padding is rows or columns of zeros added to the borders of an image input. By adjusting the padding, you can control the output size of the layer.

This image shows a 3-by-3 filter scanning through the input with padding of size 1. The lower map represents the input and the upper map represents the output.

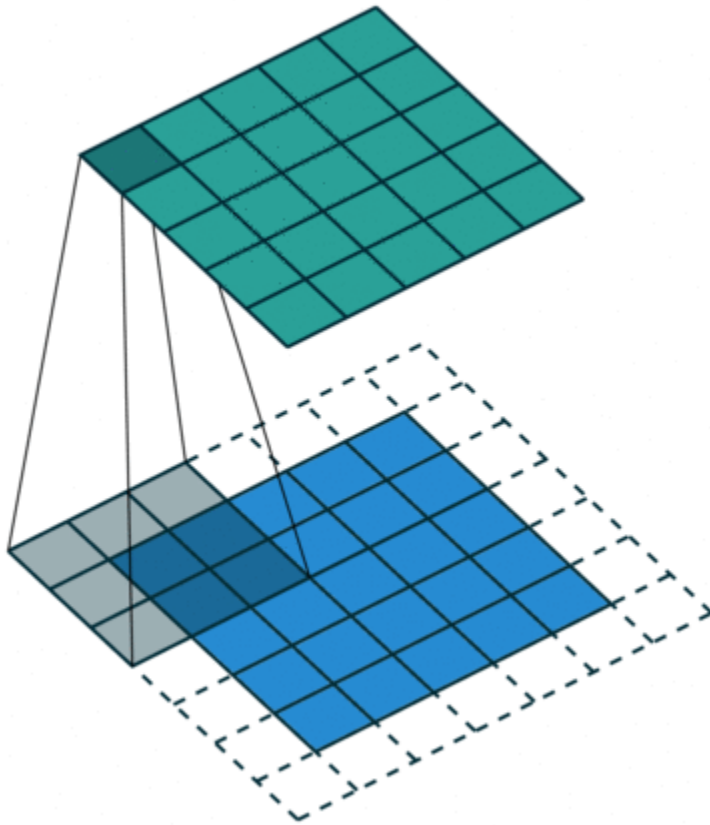

### Output Size

The output height and width of a convolutional layer is  $(Input\ Size - ((Filter\ Size - 1) * Dilation\ Factor + 1) + 2 * Padding) / Stride + 1$ . This value must be an integer for the whole image to be fully covered. If the combination of these options does not lead the image to be fully covered, the software by default ignores the remaining part of the image along the right and bottom edges in the convolution.

### Number of Neurons

The product of the output height and width gives the total number of neurons in a feature map, say *Map Size*. The total number of neurons (output size) in a convolutional layer is  $Map\ Size * Number\ of\ Filters$ .

For example, suppose that the input image is a 32-by-32-by-3 color image. For a convolutional layer with eight filters and a filter size of 5-by-5, the number of weights per filter is  $5 * 5 * 3 = 75$ , and the total number of parameters in the layer is  $(75 + 1) * 8 = 608$ . If the stride is 2 in each direction and padding of size 2 is specified, then each feature map is 16-by-16. This is because  $(32 - 5 + 2 * 2) / 2 + 1 = 16.5$ , and some of the outermost zero padding to the right and bottom of the image is discarded. Finally, the total number of neurons in the layer is  $16 * 16 * 8 = 2048$ .

Usually, the results from these neurons pass through some form of nonlinearity, such as rectified linear units (ReLU).

### **Learnable Parameters**

You can adjust the learning rates and regularization options for the layer using name-value pair arguments while defining the convolutional layer. If you choose not to specify these options, then `trainNetwork` uses the global training options defined with the `trainingOptions` function. For details on global and layer training options, see “Set Up Parameters and Train Convolutional Neural Network”.

### **Number of Layers**

A convolutional neural network can consist of one or multiple convolutional layers. The number of convolutional layers depends on the amount and complexity of the data.

## **Compatibility Considerations**

### **Default weights initialization is Glorot**

*Behavior changed in R2019a*

Starting in R2019a, the software, by default, initializes the layer weights of this layer using the Glorot initializer. This behavior helps stabilize training and usually reduces the training time of deep networks.

In previous releases, the software, by default, initializes the layer weights by sampling from a normal distribution with zero mean and variance 0.01. To reproduce this behavior, set the 'WeightsInitializer' option of the layer to 'narrow-normal'.

## **References**

- [1] LeCun, Y., B. Boser, J. S. Denker, D. Henderson, R. E. Howard, W. Hubbard, and L. D. Jackel. "Handwritten Digit Recognition with a Back-Propagation Network." In *Advances in Neural Information Processing Systems 2* (D. Touretzky, ed.). San Francisco: Morgan Kaufmann, 1990.
- [2] LeCun, Y., L. Bottou, Y. Bengio, and P. Haffner. "Gradient-Based Learning Applied to Document Recognition." *Proceedings of the IEEE*. Vol. 86, Number 11, 1998, pp. 2278-2324.
- [3] Murphy, K. P. *Machine Learning: A Probabilistic Perspective*. Cambridge, MA: MIT Press, 2012.
- [4] Glorot, Xavier, and Yoshua Bengio. "Understanding the difficulty of training deep feedforward neural networks." In *Proceedings of the thirteenth international conference on artificial intelligence and statistics*, pp. 249-256. 2010.
- [5] He, Kaiming, Xiangyu Zhang, Shaoqing Ren, and Jian Sun. "Delving deep into rectifiers: Surpassing human-level performance on imagenet classification." In *Proceedings of the IEEE international conference on computer vision*, pp. 1026-1034. 2015.

## **Extended Capabilities**

### **GPU Code Generation**

Generate CUDA® code for NVIDIA® GPUs using GPU Coder™.

**See Also**

**Deep Network Designer** | [batchNormalizationLayer](#) | [fullyConnectedLayer](#) | [groupedConvolution2dLayer](#) | [maxPooling2dLayer](#) | [reluLayer](#) | [trainNetwork](#)

**Topics**

[“Create Simple Deep Learning Network for Classification”](#)

[“Train Convolutional Neural Network for Regression”](#)

[“Deep Learning in MATLAB”](#)

[“Specify Layers of Convolutional Neural Network”](#)

[“Compare Layer Weight Initializers”](#)

[“List of Deep Learning Layers”](#)

**Introduced in R2016a**

# convolution3dLayer

3-D convolutional layer

## Description

A 3-D convolutional layer applies sliding cuboidal convolution filters to three-dimensional input. The layer convolves the input by moving the filters along the input vertically, horizontally, and along the depth, computing the dot product of the weights and the input, and then adding a bias term.

## Creation

### Syntax

```
layer = convolution3dLayer(filterSize,numFilters)
layer = convolution3dLayer(filterSize,numFilters,Name,Value)
```

### Description

`layer = convolution3dLayer(filterSize,numFilters)` creates a 3-D convolutional layer and sets the `FilterSize` and `NumFilters` properties.

`layer = convolution3dLayer(filterSize,numFilters,Name,Value)` sets the optional `Stride`, `DilationFactor`, `NumChannels`, “Parameters and Initialization” on page 1-233, “Learn Rate and Regularization” on page 1-234, and `Name` properties using name-value pairs. To specify input padding, use the 'Padding' name-value pair argument. For example, `convolution3dLayer(11,96,'Stride',4,'Padding',1)` creates a 3-D convolutional layer with 96 filters of size [11 11 11], a stride of [4 4 4], and zero padding of size 1 along all edges of the layer input. You can specify multiple name-value pairs. Enclose each property name in single quotes.

### Input Arguments

#### Name-Value Pair Arguments

Use comma-separated name-value pair arguments to specify the size of the zero padding to add along the edges of the layer input or to set the `Stride`, `DilationFactor`, `NumChannels`, “Parameters and Initialization” on page 1-233, “Learn Rate and Regularization” on page 1-234, and `Name` properties. Enclose names in single quotes.

Example: `convolution3dLayer(3,16,'Padding','same')` creates a 3-D convolutional layer with 16 filters of size [3 3 3] and 'same' padding. At training time, the software calculates and sets the size of the zero padding so that the layer output has the same size as the input.

#### Padding — Input edge padding

0 (default) | array of nonnegative integers | 'same'

Input edge padding, specified as the comma-separated pair consisting of 'Padding' and one of these values:



- `'same'` — Add padding of size calculated by the software at training or prediction time so that the output has the same size as the input when the stride equals 1. If the stride is larger than 1, then the output size is  $\text{ceil}(\text{inputSize}/\text{stride})$ , where `inputSize` is the height, width, or depth of the input and `stride` is the stride in the corresponding dimension. The software adds the same amount of padding to the top and bottom, to the left and right, and to the front and back, if possible. If the padding in a given dimension has an odd value, then the software adds the extra padding to the input as postpadding. In other words, the software adds extra vertical padding to the bottom, extra horizontal padding to the right, and extra depth padding to the back of the input.
- Nonnegative integer `p` — Add padding of size `p` to all the edges of the input.
- Three-element vector `[a b c]` of nonnegative integers — Add padding of size `a` to the top and bottom, padding of size `b` to the left and right, and padding of size `c` to the front and back of the input.
- 2-by-3 matrix `[t l f; b r k]` of nonnegative integers — Add padding of size `t` to the top, `b` to the bottom, `l` to the left, `r` to the right, `f` to the front, and `k` to the back of the input. In other words, the top row specifies the prepadding and the second row defines the postpadding in the three dimensions.

Example: `'Padding', 1` adds one row of padding to the top and bottom, one column of padding to the left and right, and one plane of padding to the front and back of the input.

Example: `'Padding', 'same'` adds padding so that the output has the same size as the input (if the stride equals 1).

## Properties

### Convolution

#### **FilterSize** — Height, width, and depth of filters

vector of three positive integers

Height, width, and depth of the filters, specified as a vector `[h w d]` of three positive integers, where `h` is the height, `w` is the width, and `d` is the depth. `FilterSize` defines the size of the local regions to which the neurons connect in the input.

When creating the layer, you can specify `FilterSize` as a scalar to use the same value for the height, width, and depth.

Example: `[5 5 5]` specifies filters with a height, width, and depth of 5.

#### **NumFilters** — Number of filters

positive integer

Number of filters, specified as a positive integer. This number corresponds to the number of neurons in the convolutional layer that connect to the same region in the input. This parameter determines the number of channels (feature maps) in the output of the convolutional layer.

Example: 96

#### **Stride** — Step size for traversing input

`[1 1 1]` (default) | vector of three positive integers

Step size for traversing the input in three dimensions, specified as a vector `[a b c]` of three positive integers, where `a` is the vertical step size, `b` is the horizontal step size, and `c` is the step size along the

depth. When creating the layer, you can specify `Stride` as a scalar to use the same value for step sizes in all three directions.

Example: `[2 3 1]` specifies a vertical step size of 2, a horizontal step size of 3, and a step size along the depth of 1.

### **DilationFactor — Factor for dilated convolution**

`[1 1 1]` (default) | vector of three positive integers

Factor for dilated convolution (also known as atrous convolution), specified as a vector `[h w d]` of three positive integers, where `h` is the vertical dilation, `w` is the horizontal dilation, and `d` is the dilation along the depth. When creating the layer, you can specify `DilationFactor` as a scalar to use the same value for dilation in all three directions.

Use dilated convolutions to increase the receptive field (the area of the input which the layer can see) of the layer without increasing the number of parameters or computation.

The layer expands the filters by inserting zeros between each filter element. The dilation factor determines the step size for sampling the input or equivalently the upsampling factor of the filter. It corresponds to an effective filter size of  $(Filter\ Size - 1) \cdot Dilation\ Factor + 1$ . For example, a 3-by-3-by-3 filter with the dilation factor `[2 2 2]` is equivalent to a 5-by-5-by-5 filter with zeros between the elements.

Example: `[2 3 1]` dilates the filter vertically by a factor of 2, horizontally by a factor of 3, and along the depth by a factor of 1.

### **PaddingSize — Size of padding**

`[0 0 0;0 0 0]` (default) | 2-by-3 matrix of nonnegative integers

Size of padding to apply to input borders, specified as 2-by-3 matrix `[t l f; b r k]` of nonnegative integers, where `t` and `b` are the padding applied to the top and bottom in the vertical direction, `l` and `r` are the padding applied to the left and right in the horizontal direction, and `f` and `k` are the padding applied to the front and back along the depth. In other words, the top row specifies the prepadding and the second row defines the postpadding in the three dimensions.

When you create a layer, use the `'Padding'` name-value pair argument to specify the padding size.

Example: `[1 2 4;1 2 4]` adds one row of padding to the top and bottom, two columns of padding to the left and right, and four planes of padding to the front and back of the input.

### **PaddingMode — Method to determine padding size**

`'manual'` (default) | `'same'`

Method to determine padding size, specified as `'manual'` or `'same'`.

The software automatically sets the value of `PaddingMode` based on the `'Padding'` value you specify when creating a layer.

- If you set the `'Padding'` option to a scalar or a vector of nonnegative integers, then the software automatically sets `PaddingMode` to `'manual'`.
- If you set the `'Padding'` option to `'same'`, then the software automatically sets `PaddingMode` to `'same'` and calculates the size of the padding at training time so that the output has the same size as the input when the stride equals 1. If the stride is larger than 1, then the output size is  $\text{ceil}(\text{inputSize}/\text{stride})$ , where `inputSize` is the height, width, or depth of the input and `stride` is the stride in the corresponding dimension. The software adds the same amount of

padding to the top and bottom, to the left and right, and to the front and back, if possible. If the padding in a given dimension has an odd value, then the software adds the extra padding to the input as postpadding. In other words, the software adds extra vertical padding to the bottom, extra horizontal padding to the right, and extra depth padding to the back of the input.

### **NumChannels — Number of channels for each filter**

'auto' (default) | positive integer

Number of channels for each filter, specified as 'auto' or a positive integer.

This parameter is always equal to the number of channels of the input to the convolutional layer. For example, if the input is a color image, then the number of channels for the input is 3. If the number of filters for the convolutional layer prior to the current layer is 16, then the number of channels for the current layer is 16.

If NumChannels is 'auto', then the software determines the number of channels at training time.

Example: 256

### **Parameters and Initialization**

#### **WeightsInitializer — Function to initialize weights**

'glorot' (default) | 'he' | 'narrow-normal' | 'zeros' | 'ones' | function handle

Function to initialize the weights, specified as one of the following:

- 'glorot' - Initialize the weights with the Glorot initializer [1] (also known as Xavier initializer). The Glorot initializer independently samples from a uniform distribution with zero mean and variance  $2/(\text{numIn} + \text{numOut})$ , where  $\text{numIn} = \text{FilterSize}(1) * \text{FilterSize}(2) * \text{FilterSize}(3) * \text{NumChannels}$  and  $\text{numOut} = \text{FilterSize}(1) * \text{FilterSize}(2) * \text{FilterSize}(3) * \text{NumFilters}$ .
- 'he' - Initialize the weights with the He initializer [2]. The He initializer samples from a normal distribution with zero mean and variance  $2/\text{numIn}$ , where  $\text{numIn} = \text{FilterSize}(1) * \text{FilterSize}(2) * \text{FilterSize}(3) * \text{NumChannels}$ .
- 'narrow-normal' - Initialize the weights by independently sampling from a normal distribution with zero mean and standard deviation 0.01.
- 'zeros' - Initialize the weights with zeros.
- 'ones' - Initialize the weights with ones.
- Function handle - Initialize the weights with a custom function. If you specify a function handle, then the function must be of the form `weights = func(sz)`, where `sz` is the size of the weights. For an example, see "Specify Custom Weight Initialization Function".

The layer only initializes the weights when the `Weights` property is empty.

Data Types: char | string | function\_handle

#### **BiasInitializer — Function to initialize bias**

'zeros' (default) | 'narrow-normal' | 'ones' | function handle

Function to initialize the bias, specified as one of the following:

- 'zeros' - Initialize the bias with zeros.
- 'ones' - Initialize the bias with ones.

- 'narrow-normal' - Initialize the bias by independently sampling from a normal distribution with zero mean and standard deviation 0.01.
- Function handle - Initialize the bias with a custom function. If you specify a function handle, then the function must be of the form `bias = func(sz)`, where `sz` is the size of the bias.

The layer only initializes the bias when the `Bias` property is empty.

Data Types: `char` | `string` | `function_handle`

### **Weights – Layer weights**

`[]` (default) | numeric array

Layer weights for the convolutional layer, specified as a numeric array.

The layer weights are learnable parameters. You can specify the initial value for the weights directly using the `Weights` property of the layer. When training a network, if the `Weights` property of the layer is nonempty, then `trainNetwork` uses the `Weights` property as the initial value. If the `Weights` property is empty, then `trainNetwork` uses the initializer specified by the `WeightsInitializer` property of the layer.

At training time, `Weights` is a `FilterSize(1)-by-FilterSize(2)-by-FilterSize(3)-by-NumChannels-by-NumFilters` array.

Data Types: `single` | `double`

### **Bias – Layer biases**

`[]` (default) | numeric array

Layer biases for the convolutional layer, specified as a numeric array.

The layer biases are learnable parameters. When training a network, if `Bias` is nonempty, then `trainNetwork` uses the `Bias` property as the initial value. If `Bias` is empty, then `trainNetwork` uses the initializer specified by `BiasInitializer`.

At training time, `Bias` is a `1-by-1-by-1-by-NumFilters` array.

Data Types: `single` | `double`

### **Learn Rate and Regularization**

#### **WeightLearnRateFactor – Learning rate factor for weights**

1 (default) | nonnegative scalar

Learning rate factor for the weights, specified as a nonnegative scalar.

The software multiplies this factor by the global learning rate to determine the learning rate for the weights in this layer. For example, if `WeightLearnRateFactor` is 2, then the learning rate for the weights in this layer is twice the current global learning rate. The software determines the global learning rate based on the settings specified with the `trainingOptions` function.

Example: 2

#### **BiasLearnRateFactor – Learning rate factor for biases**

1 (default) | nonnegative scalar

Learning rate factor for the biases, specified as a nonnegative scalar.

The software multiplies this factor by the global learning rate to determine the learning rate for the biases in this layer. For example, if `BiasLearnRateFactor` is 2, then the learning rate for the biases in the layer is twice the current global learning rate. The software determines the global learning rate based on the settings specified with the `trainingOptions` function.

Example: 2

### **WeightL2Factor — L2 regularization factor for weights**

1 (default) | nonnegative scalar

L2 regularization factor for the weights, specified as a nonnegative scalar.

The software multiplies this factor by the global L2 regularization factor to determine the L2 regularization for the weights in this layer. For example, if `WeightL2Factor` is 2, then the L2 regularization for the weights in this layer is twice the global L2 regularization factor. You can specify the global L2 regularization factor using the `trainingOptions` function.

Example: 2

### **BiasL2Factor — L2 regularization factor for biases**

0 (default) | nonnegative scalar

L2 regularization factor for the biases, specified as a nonnegative scalar.

The software multiplies this factor by the global L2 regularization factor to determine the L2 regularization for the biases in this layer. For example, if `BiasL2Factor` is 2, then the L2 regularization for the biases in this layer is twice the global L2 regularization factor. You can specify the global L2 regularization factor using the `trainingOptions` function.

Example: 2

## **Layer**

### **Name — Layer name**

' ' (default) | character vector | string scalar

Layer name, specified as a character vector or a string scalar. To include a layer in a layer graph, you must specify a nonempty unique layer name. If you train a series network with the layer and `Name` is set to ' ', then the software automatically assigns a name to the layer at training time.

Data Types: char | string

### **NumInputs — Number of inputs**

1 (default)

Number of inputs of the layer. This layer accepts a single input only.

Data Types: double

### **InputNames — Input names**

{ 'in' } (default)

Input names of the layer. This layer accepts a single input only.

Data Types: cell

### **NumOutputs — Number of outputs**

1 (default)

Number of outputs of the layer. This layer has a single output only.

Data Types: double

### OutputNames — Output names

{'out'} (default)

Output names of the layer. This layer has a single output only.

Data Types: cell

## Examples

### Create 3-D Convolution Layer

Create a 3-D convolution layer with 16 filters, each with a height, width, and depth of 5. Use a stride (step size) of 4 in all three directions.

```
layer = convolution3dLayer(5,16,'Stride',4)
```

```
layer =  
Convolution3DLayer with properties:
```

```
    Name: ''
```

```
Hyperparameters
```

```
    FilterSize: [5 5 5]
```

```
    NumChannels: 'auto'
```

```
    NumFilters: 16
```

```
    Stride: [4 4 4]
```

```
    DilationFactor: [1 1 1]
```

```
    PaddingMode: 'manual'
```

```
    PaddingSize: [2x3 double]
```

```
Learnable Parameters
```

```
    Weights: []
```

```
    Bias: []
```

```
Show all properties
```

Include a 3-D convolution layer in a Layer array.

```
layers = [ ...  
    image3dInputLayer([28 28 28 3])  
    convolution3dLayer(5,16,'Stride',4)  
    reluLayer  
    maxPooling3dLayer(2,'Stride',4)  
    fullyConnectedLayer(10)  
    softmaxLayer  
    classificationLayer]
```

```
layers =  
7x1 Layer array with layers:
```

```
 1 '' 3-D Image Input  
 2 '' Convolution
```

```
28x28x28x3 images with 'zerocenter' normalization  
16 5x5x5 convolutions with stride [4 4 4] and padding [0
```

```

3 '' ReLU ReLU
4 '' 3-D Max Pooling 2x2x2 max pooling with stride [4 4 4] and padding [0 0
5 '' Fully Connected 10 fully connected layer
6 '' Softmax softmax
7 '' Classification Output crossentropyex

```

### Specify Initial Weights and Biases in 3-D Convolutional Layer

To specify the weights and bias initializer functions, use the `WeightsInitializer` and `BiasInitializer` properties respectively. To specify the weights and biases directly, use the `Weights` and `Bias` properties respectively.

#### Specify Initialization Functions

Create a 3-D convolutional layer with 32 filters, each with a height, width, and depth of 5. Specify the weights initializer to be the He initializer.

```

filterSize = 5;
numFilters = 32;
layer = convolution3dLayer(filterSize,numFilters, ...
    'WeightsInitializer','he')

```

```

layer =
    Convolution3DLayer with properties:

```

```

        Name: ''

```

```

    Hyperparameters

```

```

        FilterSize: [5 5 5]

```

```

        NumChannels: 'auto'

```

```

        NumFilters: 32

```

```

        Stride: [1 1 1]

```

```

        DilationFactor: [1 1 1]

```

```

        PaddingMode: 'manual'

```

```

        PaddingSize: [2x3 double]

```

```

    Learnable Parameters

```

```

        Weights: []

```

```

        Bias: []

```

```

    Show all properties

```

Note that the `Weights` and `Bias` properties are empty. At training time, the software initializes these properties using the specified initialization functions.

#### Specify Custom Initialization Functions

To specify your own initialization function for the weights and biases, set the `WeightsInitializer` and `BiasInitializer` properties to a function handle. For these properties, specify function handles that take the size of the weights and biases as input and output the initialized value.

Create a convolutional layer with 32 filters, each with a height, width, and depth of 5. Specify initializers that sample the weights and biases from a Gaussian distribution with a standard deviation of 0.0001.

```
filterSize = 5;
numFilters = 32;

layer = convolution3dLayer(filterSize,numFilters, ...
    'WeightsInitializer', @(sz) rand(sz) * 0.0001, ...
    'BiasInitializer', @(sz) rand(sz) * 0.0001)

layer =
    Convolution3DLayer with properties:

        Name: ''

    Hyperparameters
        FilterSize: [5 5 5]
        NumChannels: 'auto'
        NumFilters: 32
        Stride: [1 1 1]
        DilationFactor: [1 1 1]
        PaddingMode: 'manual'
        PaddingSize: [2x3 double]

    Learnable Parameters
        Weights: []
        Bias: []

    Show all properties
```

Again, the `Weights` and `Bias` properties are empty. At training time, the software initializes these properties using the specified initialization functions.

### Specify Weights and Bias Directly

Create a 3-D convolutional layer compatible with color images. Set the weights and bias to `W` and `b` in the MAT file `Conv3dWeights.mat` respectively.

```
filterSize = 5;
numFilters = 32;
load Conv3dWeights

layer = convolution3dLayer(filterSize,numFilters, ...
    'Weights',W, ...
    'Bias',b)

layer =
    Convolution3DLayer with properties:

        Name: ''

    Hyperparameters
        FilterSize: [5 5 5]
        NumChannels: 3
        NumFilters: 32
        Stride: [1 1 1]
        DilationFactor: [1 1 1]
        PaddingMode: 'manual'
        PaddingSize: [2x3 double]
```



```

Learnable Parameters
  Weights: [5-D double]
  Bias: [1x1x1x32 double]

```

Show all properties

Here, the `Weights` and `Bias` properties contain the specified values. At training time, if these properties are non-empty, then the software uses the specified values as the initial weights and biases. In this case, the software does not use the initializer functions.

### Create Convolutional Layer That Fully Covers 3-D Input

Suppose the size of the input is 28-by-28-by-28-by-1. Create a 3-D convolutional layer with 16 filters, each with a height of 6, a width of 4, and a depth of 5. Set the stride in all dimensions to 4.

Make sure the convolution covers the input completely. For the convolution to fully cover the input, the output dimensions must be integer numbers. When there is no dilation, the  $i$ -th output dimension is calculated as  $(\text{imageSize}(i) - \text{filterSize}(i) + \text{padding}(i)) / \text{stride}(i) + 1$ .

- For the horizontal output dimension to be an integer, two rows of zero padding are required:  $(28 - 6 + 2)/4 + 1 = 7$ . Distribute the padding symmetrically by adding one row of padding at the top and bottom of the image.
- For the vertical output dimension to be an integer, no zero padding is required:  $(28 - 4 + 0)/4 + 1 = 7$ .
- For the depth output dimension to be an integer, one plane of zero padding is required:  $(28 - 5 + 1)/4 + 1 = 7$ . You must distribute the padding asymmetrically across the front and back of the image. This example adds one plane of zero padding to the back of the image.

Construct the convolutional layer. Specify 'Padding' as a 2-by-3 matrix. The first row specifies prepadding and the second row specifies postpadding in the three dimensions.

```
layer = convolution3dLayer([6 4 5],16,'Stride',4,'Padding',[1 0 0;1 0 1])
```

```
layer =
  Convolution3DLayer with properties:
```

```

      Name: ''

Hyperparameters
  FilterSize: [6 4 5]
  NumChannels: 'auto'
  NumFilters: 16
  Stride: [4 4 4]
  DilationFactor: [1 1 1]
  PaddingMode: 'manual'
  PaddingSize: [2x3 double]

```

```

Learnable Parameters
  Weights: []
  Bias: []

```

Show all properties

## More About

### 3-D Convolutional Layer

A convolutional layer applies sliding convolutional filters to the input. A 3-D convolutional layer extends the functionality of a 2-D convolutional layer to a third dimension, depth. The layer convolves the input by moving the filters along the input vertically, horizontally, and along the depth, computing the dot product of the weights and the input, and then adding a bias term. To learn more, see the definition of convolutional layer on page 1-224 on the `convolution2dLayer` reference page.

## References

- [1] Glorot, Xavier, and Yoshua Bengio. "Understanding the difficulty of training deep feedforward neural networks." In *Proceedings of the thirteenth international conference on artificial intelligence and statistics*, pp. 249-256. 2010.
- [2] He, Kaiming, Xiangyu Zhang, Shaoqing Ren, and Jian Sun. "Delving deep into rectifiers: Surpassing human-level performance on imagenet classification." In *Proceedings of the IEEE international conference on computer vision*, pp. 1026-1034. 2015.

## See Also

`convolution2dLayer` | `globalAveragePooling3dLayer` | `image3dInputLayer` | `maxPooling3dLayer`

## Topics

"3-D Brain Tumor Segmentation Using Deep Learning"  
"Deep Learning in MATLAB"  
"Specify Layers of Convolutional Neural Network"  
"Compare Layer Weight Initializers"  
"List of Deep Learning Layers"

## Introduced in R2019a

# crop2dLayer

2-D crop layer

## Description

A 2-D crop layer applies 2-D cropping to the input.

There are two inputs to this layer:

- 'in' — The feature map that will be cropped
- 'ref' — A reference layer used to determine the size, *[height width]*, of the cropped output

Once you create this layer, you can add it to a `layerGraph` to make serial connections between layers. To connect the crop layer to other layers, call `connectLayers` and specify the input names. The `connectLayers` function returns a connected `LayerGraph` object ready to train a network.

### Create array of layers

```
layers = [imageInputLayer(...,'Name','image')
          convolution2dLayer(...,'Name','conv')
          ...
          transposedConv2dLayer(...,'Name','tconv')
          crop2dLayer(cropType,'Name','crop')]
          pixelClassificationLayer('Name','pixlabels']]
```

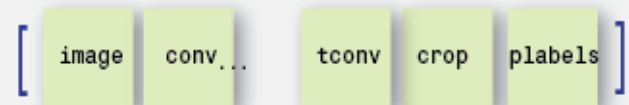

### Create collection of connected layers

```
lgraph = layerGraph(layers)
```

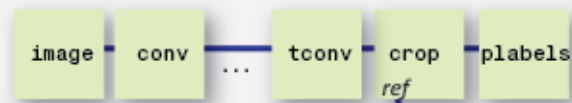

### Connect second input of crop layer

```
lgraph = connectLayers(lgraph,'image/out','crop/ref')
```

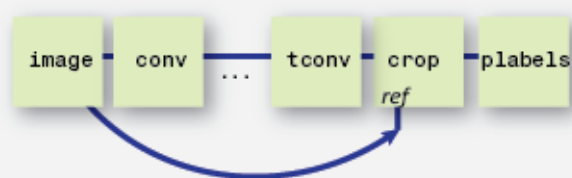

### Train Network

```
net = trainNetwork(data,lgraph,opts)
```



## Creation

### Syntax

```
layer = crop2dLayer(Mode)
layer = crop2dLayer(Location)
layer = crop2dLayer( ____, 'Name', Name)
```

### Description

`layer = crop2dLayer(Mode)` returns a layer that crops an input feature map, and sets the `Mode` property.

`layer = crop2dLayer(Location)` returns a layer that crops an input feature map using a rectangular window, and sets the `Location` property that indicates the position of the window.

`layer = crop2dLayer( ____, 'Name', Name)` creates a layer for cropping and sets the optional `Name` property.

### Properties

#### Mode — Cropping mode

'centercrop' (default) | 'custom'

Cropping mode, specified as 'centercrop' or 'custom'.

Mode	Description
'centercrop'	The location of the cropping window is the center of the input feature map.
'custom'	The location of the cropping window is based on the <code>Location</code> property. This value is automatically set when the <code>Location</code> property is specified as a 2-element row vector.

Data Types: char

#### Location — Cropping window location

'auto' (default) | 2-element row vector

Cropping window location, specified as 'auto' or a 2-element row vector.

Location	Description
2-element row vector in the format [x y]	The upper-left corner of the cropping window is at the location [x y] of the input feature map. x indicates the location in the horizontal direction and y is the vertical direction.
'auto'	The cropping window is located at the center of the input feature map. This value is automatically set when the <code>Mode</code> property is specified as 'centercrop'.

#### Name — Layer name

' ' (default) | character vector | string scalar

Layer name, specified as a character vector or a string scalar. To include a layer in a layer graph, you must specify a nonempty unique layer name. If you train a series network with the layer and Name is set to '', then the software automatically assigns a name to the layer at training time.

Data Types: char | string

### **NumInputs — Number of inputs**

2 (default)

Number of inputs of the layer. This layer has two inputs.

Data Types: double

### **InputNames — Input names**

{'in' 'ref'} (default)

Input names of the layer. This layer has two inputs, named 'in' and 'ref'.

Data Types: cell

### **NumOutputs — Number of outputs**

1 (default)

Number of outputs of the layer. This layer has a single output only.

Data Types: double

### **OutputNames — Output names**

{'out'} (default)

Output names of the layer. This layer has a single output only.

Data Types: cell

## **Examples**

### **Create 2-D Crop Layer**

Create a 2-D crop layer and connect both of the inputs using a layerGraph object.

Create the layers.

```
layers = [
    imageInputLayer([32 32 3], 'Name', 'image')
    crop2dLayer('centercrop', 'Name', 'crop')]
```

```
layers =
    2x1 Layer array with layers:
```

1	'image'	Image Input	32x32x3 images with 'zerocenter' normalization
2	'crop'	Crop 2D	center crop

Create a layerGraph. The first input of crop2dLayer is automatically connected to the first output of the image input layer.

```
lgraph = layerGraph(layers)
```

```
lgraph =  
    LayerGraph with properties:  
  
        Layers: [2×1 nnet.cnn.layer.Layer]  
        Connections: [1×2 table]  
        InputNames: {'image'}  
        OutputNames: {1×0 cell}
```

Connect the image input layer to the "ref" input of the 2-D crop layer.

```
lgraph = connectLayers(lgraph, 'image', 'crop/ref')
```

```
lgraph =  
    LayerGraph with properties:  
  
        Layers: [2×1 nnet.cnn.layer.Layer]  
        Connections: [2×2 table]  
        InputNames: {'image'}  
        OutputNames: {1×0 cell}
```

## Extended Capabilities

### GPU Code Generation

Generate CUDA® code for NVIDIA® GPUs using GPU Coder™.

### See Also

[deeplabv3plusLayers](#) | [fcnLayers](#) | [layerGraph](#) | [pixelClassificationLayer](#) | [segnetLayers](#) | [semanticseg](#) | [trainNetwork](#) | [unetLayers](#)

### Topics

“Getting Started with Semantic Segmentation Using Deep Learning” (Computer Vision Toolbox)  
“Deep Learning in MATLAB”

### Introduced in R2017b

# crop3dLayer

3-D crop layer

## Description

A 3-D crop layer crops a 3-D volume to the size of the input feature map.

Specify the number of inputs to the layer when you create it. The inputs to the layer have the names 'in' and 'ref'. Use the input names when connecting or disconnecting the layer by using `connectLayers` or `disconnectLayers`. All inputs to a 3-D crop layer must have the same number of dimensions.

## Creation

### Syntax

```
layer = crop3dLayer
layer = crop3dLayer([X Y Z])
layer = crop3dLayer( ____, 'Name', Name)
```

### Description

`layer = crop3dLayer` creates a 3-D crop layer that crops an input feature map from the center of the feature map. The size of the cropped region is equal to the size of a second reference input feature map.

`layer = crop3dLayer([X Y Z])` also sets the `cropLocation` property with the (X,Y,Z) coordinate of the crop window. X is the coordinate in the horizontal direction, Y is the coordinate in the vertical direction, and Z is the coordinate in the depth direction.

`layer = crop3dLayer( ____, 'Name', Name)` also sets the `Name` property. To create a network containing a 3-D crop layer, you must specify a layer name.

## Properties

### Crop

#### cropLocation — Crop location

'centercrop' (default) | three-element numeric vector

Crop location, specified as 'centercrop' or a three-element numeric vector representing the (x,y,z) coordinate of the crop window.

### Layer

#### Name — Layer name

' ' (default) | character vector | string scalar

Layer name, specified as a character vector or a string scalar. To include a layer in a layer graph, you must specify a nonempty unique layer name. If you train a series network with the layer and Name is set to '', then the software automatically assigns a name to the layer at training time.

Data Types: char | string

### NumInputs — Number of inputs

2 (default)

Number of inputs of the layer. This layer accepts two inputs.

Data Types: double

### InputNames — Input names

{'in', 'ref'} (default)

Input names of the layer, specified as {'in', 'ref'}. This layer accepts two inputs.

Data Types: cell

### NumOutputs — Number of outputs

1 (default)

Number of outputs of the layer. This layer has a single output only.

Data Types: double

### OutputNames — Output names

{'out'} (default)

Output names of the layer. This layer has a single output only.

Data Types: cell

## Examples

### Create and Connect 3-D Crop Layer

Create a 3-D crop layer and connect both of its inputs using a layerGraph object.

```
layers = [
    image3dInputLayer([32 32 32 3], 'Name', 'image')
    convolution3dLayer(3, 16, 'Padding', 'same', 'Name', 'conv')
    crop3dLayer('Name', 'crop')
    concatenationLayer(4, 2, 'Name', 'concat')
]
```

layers =

4x1 Layer array with layers:

1	'image'	3-D Image Input	32x32x32x3 images with 'zerocenter' normalization
2	'conv'	Convolution	16 3x3x3 convolutions with stride [1 1 1] and padding 'same'
3	'crop'	Crop 3D	center crop
4	'concat'	Concatenation	Concatenation of 2 inputs along dimension 4

Create a layer graph. The first input of the 3-D crop layer is automatically connected to the output of the 3-D convolutional layer.



```
lgraph = layerGraph(layers);
```

Add a max pooling layer to the layer graph.

```
maxPool = maxPooling3dLayer(2, 'stride', 2, 'Name', 'pool');
lgraph = addLayers(lgraph, maxPool);
lgraph = connectLayers(lgraph, 'image', 'pool');
```

Connect the second input of the crop layer to the output of the max pooling layer.

```
lgraph = connectLayers(lgraph, 'pool', 'crop/ref');
```

Concatenate the crop layer output and the max pooling layer output.

```
lgraph = connectLayers(lgraph, 'pool', 'concat/in2');
```

Display the layer graph.

```
plot(lgraph)
```

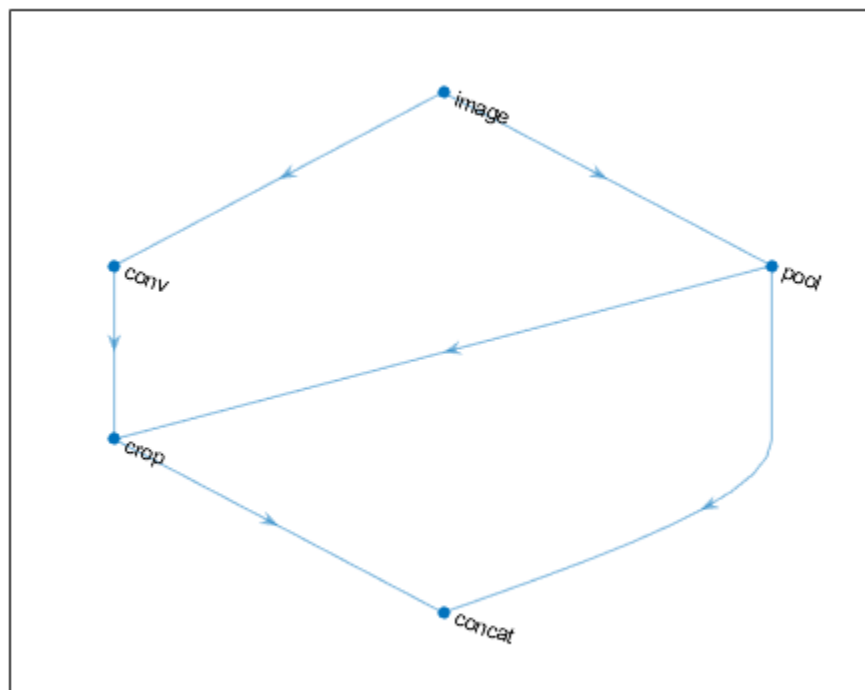

## See Also

[crop2dLayer](#) | [layerGraph](#) | [trainNetwork](#)

## Topics

“Deep Learning in MATLAB”

“Set Up Parameters and Train Convolutional Neural Network”

“Specify Layers of Convolutional Neural Network”  
“List of Deep Learning Layers”

**Introduced in R2019b**

# crossChannelNormalizationLayer

Channel-wise local response normalization layer

## Description

A channel-wise local response (cross-channel) normalization layer carries out channel-wise normalization.

## Creation

### Syntax

```
layer = crossChannelNormalizationLayer(windowChannelSize)
layer = crossChannelNormalizationLayer(windowChannelSize,Name,Value)
```

### Description

`layer = crossChannelNormalizationLayer(windowChannelSize)` creates a channel-wise local response normalization layer and sets the `WindowChannelSize` property.

`layer = crossChannelNormalizationLayer(windowChannelSize,Name,Value)` sets the optional properties `WindowChannelSize`, `Alpha`, `Beta`, `K`, and `Name` using name-value pairs. For example, `crossChannelNormalizationLayer(5, 'K', 1)` creates a local response normalization layer for channel-wise normalization with a window size of 5 and `K` hyperparameter 1. You can specify multiple name-value pairs. Enclose each property name in single quotes.

## Properties

### Cross-Channel Normalization

#### WindowChannelSize — Size of the channel window

positive integer

Size of the channel window, which controls the number of channels that are used for the normalization of each element, specified as a positive integer.

If `WindowChannelSize` is even, then the window is asymmetric. The software looks at the previous `floor((w-1)/2)` channels and the following `floor(w/2)` channels. For example, if `WindowChannelSize` is 4, then the layer normalizes each element by its neighbor in the previous channel and by its neighbors in the next two channels.

Example: 5

#### Alpha — $\alpha$ hyperparameter in normalization

0.0001 (default) | numeric scalar

$\alpha$  hyperparameter in the normalization (the multiplier term), specified as a numeric scalar.

Example: 0.0002

**Beta —  $\beta$  hyperparameter in normalization**

0.75 (default) | numeric scalar

$\beta$  hyperparameter in the normalization, specified as a numeric scalar. The value of **Beta** must be greater than or equal to 0.01.

Example: 0.8

**K — K hyperparameter in the normalization**

2 (default) | numeric scalar

$K$  hyperparameter in the normalization, specified as a numeric scalar. The value of **K** must be greater than or equal to  $10^{-5}$ .

Example: 2.5

**Layer****Name — Layer name**

' ' (default) | character vector | string scalar

Layer name, specified as a character vector or a string scalar. To include a layer in a layer graph, you must specify a nonempty unique layer name. If you train a series network with the layer and **Name** is set to ' ', then the software automatically assigns a name to the layer at training time.

Data Types: char | string

**NumInputs — Number of inputs**

1 (default)

Number of inputs of the layer. This layer accepts a single input only.

Data Types: double

**InputNames — Input names**

'in' (default)

Input names of the layer. This layer accepts a single input only.

Data Types: cell

**NumOutputs — Number of outputs**

1 (default)

Number of outputs of the layer. This layer has a single output only.

Data Types: double

**OutputNames — Output names**

'out' (default)

Output names of the layer. This layer has a single output only.

Data Types: cell

**Examples**

## Create Local Response Normalization Layer

Create a local response normalization layer for channel-wise normalization, where a window of five channels normalizes each element, and the additive constant for the normalizer  $K$  is 1.

```
layer = crossChannelNormalizationLayer(5, 'K', 1)

layer =
  CrossChannelNormalizationLayer with properties:

        Name: ''

Hyperparameters
  WindowChannelSize: 5
        Alpha: 1.0000e-04
        Beta: 0.7500
        K: 1
```

Include a local response normalization layer in a Layer array.

```
layers = [ ...
  imageInputLayer([28 28 1])
  convolution2dLayer(5,20)
  reluLayer
  crossChannelNormalizationLayer(3)
  fullyConnectedLayer(10)
  softmaxLayer
  classificationLayer]

layers =
  7x1 Layer array with layers:

     1  ''  Image Input           28x28x1 images with 'zerocenter' normalization
     2  ''  Convolution          20 5x5 convolutions with stride [1 1] and padding [1 1]
     3  ''  ReLU                 ReLU
     4  ''  Cross Channel Normalization  cross channel normalization with 3 channels per element
     5  ''  Fully Connected      10 fully connected layer
     6  ''  Softmax              softmax
     7  ''  Classification Output  crossentropyex
```

## Limitations

- This layer does not support 3-D image inputs or vector sequence inputs.

## More About

### Local Response Normalization

A channel-wise local response (cross-channel) normalization layer carries out channel-wise normalization.

This layer performs a channel-wise local response normalization. It usually follows the ReLU activation layer. This layer replaces each element with a normalized value it obtains using the elements from a certain number of neighboring channels (elements in the normalization window). That is, for each element  $x$  in the input, `trainNetwork` computes a normalized value  $x'$  using

$$x' = \frac{x}{\left(K + \frac{\alpha * ss}{windowChannelSize}\right)^\beta},$$

where  $K$ ,  $\alpha$ , and  $\beta$  are the hyperparameters in the normalization, and  $ss$  is the sum of squares of the elements in the normalization window [1]. You must specify the size of the normalization window using the `windowChannelSize` argument of the `crossChannelNormalizationLayer` function. You can also specify the hyperparameters using the `Alpha`, `Beta`, and `K` name-value pair arguments.

The previous normalization formula is slightly different than what is presented in [1]. You can obtain the equivalent formula by multiplying the `alpha` value by the `windowChannelSize`.

## References

[1] Krizhevsky, A., I. Sutskever, and G. E. Hinton. "ImageNet Classification with Deep Convolutional Neural Networks." *Advances in Neural Information Processing Systems*. Vol 25, 2012.

## Extended Capabilities

### GPU Code Generation

Generate CUDA® code for NVIDIA® GPUs using GPU Coder™.

## See Also

[averagePooling2dLayer](#) | [convolution2dLayer](#) | [maxPooling2dLayer](#)

### Topics

"Create Simple Deep Learning Network for Classification"  
"Train Convolutional Neural Network for Regression"  
"Deep Learning in MATLAB"  
"Specify Layers of Convolutional Neural Network"  
"List of Deep Learning Layers"

### Introduced in R2016a

# crosschannelnorm

Cross channel square-normalize using local responses

## Syntax

```
dLY = crosschannelnorm(dlX,windowSize)
dLY = crosschannelnorm(dlX,windowSize,'DataFormat',FMT)
dLY = crosschannelnorm( ____,Name,Value)
```

## Description

The cross-channel normalization operation uses local responses in different channels to normalize each activation. Cross-channel normalization typically follows a `relu` operation. Cross-channel normalization is also known as local response normalization.

---

**Note** This function applies the cross-channel normalization operation to `dlarray` data. If you want to apply cross-channel normalization within a `layerGraph` object or `Layer` array, use the following layer:

- `crossChannelNormalizationLayer`
- 

`dLY = crosschannelnorm(dlX,windowSize)` normalizes each element of `dlX` with respect to local values in the same position in nearby channels. The normalized elements in `dLY` are calculated from the elements in `dlX` using the following formula.

$$y = \frac{x}{\left(K + \frac{\alpha * ss}{windowSize}\right)^\beta}$$

where  $y$  is an element of `dLY`,  $x$  is the corresponding element of `dlX`,  $ss$  is the sum of the squares of the elements in the channel region defined by `windowSize`, and  $\alpha$ ,  $\beta$ , and  $K$  are hyperparameters in the normalization.

`dLY = crosschannelnorm(dlX,windowSize,'DataFormat',FMT)` also specifies the dimension format `FMT` when `dlX` is an unformatted `dlarray`, in addition to the input arguments the previous syntax. The output `dLY` is an unformatted `dlarray` with the same dimension order as `dlX`.

`dLY = crosschannelnorm( ____,Name,Value)` specifies options using one or more name-value pair arguments in addition to the input arguments in previous syntaxes. For example, `'Beta',0.8` sets the value of the  $\beta$  contrast constant to `0.8`.

## Examples

### Normalize Data Using Values of Adjacent Channels

Use `crosschannelnorm` to normalize each observation of a mini-batch using values from adjacent channels.

Create the input data as ten observations of random values with a height and width of eight and six channels.

```
height = 8;
width = 8;
channels = 6;
observations = 10;

X = rand(height,width,channels,observations);
d1X = dlarray(X, 'SSCB');
```

Compute the cross-channel normalization using a channel window size of three.

```
d1Y = crosschannelnorm(d1X,3);
```

Each value in each observation of `d1X` is normalized using the element in the previous channel and the element in the next channel.

### Compare Normalized and Original Data

Values at the edges of an array are normalized using contributions from fewer channels, depending on the size of the channel window.

Create the input data as an array of ones with a height and width of two and three channels.

```
height = 2;
width = 2;
channels = 3;

X = ones(height,width,channels);
d1X = dlarray(X);
```

Normalize the data using a channel-window size of 3, an  $\alpha$  of 1, a  $\beta$  of 1, and a  $K$  of  $1e-5$ . Specify a data format of 'SSC'.

```
d1Y = crosschannelnorm(d1X,3, 'Alpha',1, 'Beta',1, 'K',1e-5, 'DataFormat', 'SSC');
```

Compare the values in the original and the normalized data by reshaping the three-channel arrays into 2-D matrices.

```
d1X = reshape(d1X,2,6)
```

```
d1X =
  2x6 dlarray
    1    1    1    1    1    1
    1    1    1    1    1    1
```

```
d1Y = reshape(d1Y,2,6)
```

```
d1Y =
  2x6 dlarray
    1.5000    1.5000    1.0000    1.0000    1.5000    1.5000
    1.5000    1.5000    1.0000    1.0000    1.5000    1.5000
```



For the first and last channels, the sum of squares is calculated using only two values. For the middle channel, the sum of squares contains the values of all three channels.

### Use Cross-Channel Normalization in a Model Function

Typically, the cross-channel normalization operation follows a ReLU operation. For example, the GoogLeNet architecture contains convolutional operations followed by ReLU and cross-channel normalization operations.

The function `modelFunction` defined at the end of this example shows how you can use cross-channel normalization in a model. Use `modelFunction` to find the grouped convolution and ReLU activation of some input data and then normalize the result using cross-channel normalization with a window size of 5.

Create the input data as a single observation of random values with a height and width of ten and four channels.

```
height = 10;
width = 10;
channels = 4;
observations = 1;
```

```
X = rand(height,width,channels,observations);
d1X = d1array(X, 'SSCB');
```

Create the parameters for the grouped convolution operation. For the weights, use a filter height and width of three, two channels per group, three filters per group, and two groups. Use a value of zero for the bias.

```
filterSize = [3 3];
numChannelsPerGroup = 2;
numFiltersPerGroup = 3 ;
numGroups = 2;
```

```
params = struct;
params.conv.weights = rand(filterSize(1),filterSize(2),numChannelsPerGroup,numFiltersPerGroup,numGroups);
params.conv.bias = 0;
```

Apply the `modelFunction` to the data `d1X`.

```
d1Y = modelFunction(d1X,params);
```

```
function d1Y = modelFunction(d1X,params)
```

```
d1Y = dlconv(d1X,params.conv.weights,params.conv.bias);
d1Y = relu(d1Y);
d1Y = crosschannelnorm(d1Y,5);
```

```
end
```

## Input Arguments

### **dLX — Input data**

`dlarray`

Input data, specified as a `dlarray` with or without data format. When `dLX` is an unformatted `dlarray`, you must specify the data format using the 'DataFormat', FMT name-value pair.

You can specify up to two dimensions in `dLX` as 'S' dimensions.

Data Types: `single` | `double`

### **windowSize — Size of channel window**

scalar integer

Size of the channel window, which controls the number of channels that are used for the normalization of each element, specified as a positive integer.

If `windowSize` is even, then the window is asymmetric. The software looks at the previous  $\text{floor}((\text{windowSize}-1)/2)$  channels and the following  $\text{floor}(\text{windowSize}/2)$  channels. For example, if `windowSize` is 4, then the function normalizes each element by its neighbor in the previous channel and by its neighbors in the next two channels.

Example: 3

Data Types: `single` | `double` | `int8` | `int16` | `int32` | `int64` | `uint8` | `uint16` | `uint32`

### **Name-Value Pair Arguments**

Specify optional comma-separated pairs of `Name`, `Value` arguments. `Name` is the argument name and `Value` is the corresponding value. `Name` must appear inside quotes. You can specify several name and value pair arguments in any order as `Name1`, `Value1`, ..., `NameN`, `ValueN`.

Example: 'Alpha', 2e-4, 'Beta', 0.8 sets the multiplicative normalization constant to 0.0002 and the contrast constant exponent to 0.8.

### **DataFormat — Dimension order of unformatted data**

char array | string

Dimension order of unformatted input data, specified as the comma-separated pair consisting of 'DataFormat' and a character array or string FMT that provides a label for each dimension of the data. Each character in FMT must be one of the following:

- 'S' — Spatial
- 'C' — Channel
- 'B' — Batch (for example, samples and observations)
- 'T' — Time (for example, sequences)
- 'U' — Unspecified

You can specify multiple dimensions labeled 'S' or 'U'. You can use the labels 'C', 'B', and 'T' at most once.

You must specify 'DataFormat' when the input data `dLX` is not a formatted `dlarray`.

Example: 'DataFormat', 'SSCB'

Data Types: char | string

### **Alpha — Normalization constant ( $\alpha$ )**

1e-4 (default) | numeric scalar

Normalization constant ( $\alpha$ ) that multiplies the sum of the squared values, specified as the comma-separated pair consisting of 'Alpha' and a numeric scalar. The default value is 1e-4.

Example: 'Alpha', 2e-4

Data Types: single | double | int8 | int16 | int32 | int64 | uint8 | uint16 | uint32

### **Beta — Contrast constant ( $\beta$ )**

0.75 (default) | numeric scalar greater than or equal to 0.01

Contrast constant ( $\beta$ ), specified as the comma-separated pair consisting of 'Beta' and a numeric scalar greater than or equal to 0.01. The default value is 0.75.

Example: 'Beta', 0.8

Data Types: single | double | int8 | int16 | int32 | int64 | uint8 | uint16 | uint32

### **K — Normalization hyperparameter ( $K$ )**

2 (default) | numeric scalar greater than or equal to 1e-5

Normalization hyperparameter ( $K$ ) used to avoid singularities in the normalization, specified as the comma-separated pair consisting of 'K' and a numeric scalar greater than or equal to 1e-5. The default value is 2.

Example: 'K', 2.5

Data Types: single | double | int8 | int16 | int32 | int64 | uint8 | uint16 | uint32

## **Output Arguments**

### **dLY — Normalized data**

dLarray

Normalized data, returned as a dLarray. The output dLY has the same underlying data type as the input dLX.

If the input data dLX is a formatted dLarray, dLY has the same dimension labels as dLX. If the input data is an unformatted dLarray, dLY is an unformatted dLarray with the same dimension order as the input data.

## **More About**

### **Cross-Channel Normalization**

The `crosschannelnorm` function normalizes each activation response based on the local responses in a specified channel window. For more information, see the definition of “Local Response Normalization” on page 1-251 on the `crossChannelNormalizationLayer` reference page.

## **Extended Capabilities**

### **GPU Arrays**

Accelerate code by running on a graphics processing unit (GPU) using Parallel Computing Toolbox™.

Usage notes and limitations:

- When the input argument `dX` is a `darray` with underlying data of type `gpuArray`, this function runs on the GPU.

For more information, see “Run MATLAB Functions on a GPU” (Parallel Computing Toolbox).

### **See Also**

`avgpool` | `darray` | `dlconv` | `dlfeval` | `dlgradient` | `maxpool`

### **Topics**

“Define Custom Training Loops, Loss Functions, and Networks”

“Train Network Using Model Function”

**Introduced in R2020a**

# crossentropy

Cross-entropy loss for classification tasks

## Syntax

```
dLY = crossentropy(dLX,targets)
dLY = crossentropy(dLX,targets,'DataFormat',FMT)
dLY = crossentropy( ____,Name,Value)
```

## Description

The cross-entropy operation computes the cross-entropy loss between network predictions and target values for single-label and multi-label classification tasks.

---

**Note** This function computes the cross-entropy loss between predictions and targets stored as `dLarray` data. If you want to calculate the cross-entropy loss within a `layerGraph` object or `Layer` array for use with `trainNetwork`, use the following layer:

- `classificationLayer`
- 

`dLY = crossentropy(dLX,targets)` computes the categorical cross-entropy loss between the predictions `dLX` and the target values `targets` for single-label classification tasks. The input `dLX` is a formatted `dLarray` with dimension labels. The output `dLY` is an unformatted scalar `dLarray` with no dimension labels.

`dLY = crossentropy(dLX,targets,'DataFormat',FMT)` also specifies the dimension format `FMT` when `dLX` is not a formatted `dLarray`.

`dLY = crossentropy( ____,Name,Value)` specifies options using one or more name-value pair arguments in addition to the input arguments in previous syntaxes. For example, `'TargetCategories','independent'` computes the cross-entropy loss for a multi-label classification task.

## Examples

### Find Cross-Entropy Loss Between Predicted and Target Labels

The cross-entropy loss evaluates how well the network predictions correspond to the target classification.

Create the input classification data as a matrix of random variables. The data contains 12 observations that can be in any of 10 categories.

```
numCategories = 10;
observations = 12;
```

```
X = rand(numCategories,observations);  
dLX = dLarray(X, 'CB');
```

Convert the category values in the data to probability scores for each category.

```
dLX = softmax(dLX);
```

Create the target data, which holds the correct category for each observation in dLX.

```
targetsIdx = randi(10,1,12);  
targets = zeros(10,12);  
for i = 1:numel(targetsIdx)  
    targets(targetsIdx(i),i) = 1;  
end
```

Compute the cross-entropy loss between the predictions and the targets.

```
dLY = crossentropy(dLX,targets)
```

```
dLY =  
    1x1 dLarray  
  
    2.3343
```

## Input Arguments

### **dLX — Predictions**

dLarray | numeric array

Predictions, specified as a dLarray with or without dimension labels or a numeric array. When dLX is not a formatted dLarray, you must specify the dimension format using 'DataFormat', FMT. If dLX is a numeric array, targets must be a dLarray.

Data Types: single | double

### **targets — Target classification labels**

dLarray | numeric array

Target classification labels, specified as a formatted or unformatted dLarray or a numeric array.

If targets is a formatted dLarray, its dimension format must be the same as the format of X, or the same as 'DataFormat' if X is unformatted

If targets is an unformatted dLarray or a numeric array, the size of targets must exactly match the size of X. The format of X or the value of 'DataFormat' is implicitly applied to targets.

Data Types: single | double

### **Name-Value Pair Arguments**

Specify optional comma-separated pairs of Name, Value arguments. Name is the argument name and Value is the corresponding value. Name must appear inside quotes. You can specify several name and value pair arguments in any order as Name1, Value1, ..., NameN, ValueN.

Example: 'TargetCategories', 'independent', 'DataFormat', 'CB' evaluates the cross-entropy loss for multi-label classification tasks and specifies the dimension order of the input data as 'CB'

### TargetCategories — Type of classification task

'exclusive' (default) | 'independent'

Type of classification task, specified as the comma-separated pair consisting of 'TargetCategories' and one of the following:

- 'exclusive' — Single-label classification. Each observation in the predictions `dLX` is exclusively assigned to one category. The function computes the loss between the target value for the single category specified by `targets` and the corresponding prediction in `dLX`, averaged over the number of observations.
- 'independent' — Multi-label classification. Each observation in the predictions `dLX` can be assigned to one or more independent categories. The function computes the sum of the loss between each category specified by `targets` and the predictions in `dLX` for those categories, averaged over the number of observations. Cross-entropy loss for this type of classification task is also known as binary cross-entropy loss.

The default value is 'exclusive'.

For single-label classification, the loss is calculated using the following formula:

$$\text{loss} = -\frac{1}{N} \sum_{i=1}^M T_i \log(X_i)$$

where  $X_i$  is the network response,  $T_i$  is the target value,  $M$  is the total number of responses in  $X$  (across all observations and categories), and  $N$  is the total number of observations in  $X$ .

For multi-label classification, the loss is calculated using the following formula:

$$\text{loss} = -\frac{1}{N} \sum_{i=1}^N \sum_{j=1}^C (T_{i,j} \log(X_{i,j}) + (1 - T_{i,j}) \log(1 - X_{i,j}))$$

where here  $X_{i,j}$  is the network response for a given category,  $T_{i,j}$  is the target value of that category, and  $C$  is the total number of categories. In this case, the cross-entropy loss is calculated as the probability of a given observation being assigned to a given category, summed over all categories and observations and normalized by the number of observations.

Example: 'TargetCategories', 'independent'

### DataFormat — Dimension order of unformatted data

char array | string

Dimension order of unformatted input data, specified as the comma-separated pair consisting of 'DataFormat' and a character array or string FMT that provides a label for each dimension of the data. Each character in FMT must be one of the following:

- 'S' — Spatial
- 'C' — Channel
- 'B' — Batch (for example, samples and observations)

- 'T' — Time (for example, sequences)
- 'U' — Unspecified

You can specify multiple dimensions labeled 'S' or 'U'. You can use the labels 'C', 'B', and 'T' at most once.

You must specify 'DataFormat' when the input data `dLX` is not a formatted `dLarray`.

Example: 'DataFormat', 'SSCB'

Data Types: `char` | `string`

## Output Arguments

### **dLY** — Cross-entropy loss

`dLarray` scalar

Cross-entropy loss, returned as a `dLarray` scalar without dimension labels. The output `dLY` has the same underlying data type as the input `dLX`.

The cross-entropy loss `dLY` is the average logarithmic loss across the 'B' batch dimension of `dLX`.

## More About

### **Cross-Entropy Loss**

The `crossentropy` function computes the cross-entropy loss for classification problems. For more information, see the definition of “Classification Output Layer” on page 1-156 on the `ClassificationOutputLayer` reference page.

## Extended Capabilities

### **GPU Arrays**

Accelerate code by running on a graphics processing unit (GPU) using Parallel Computing Toolbox™.

Usage notes and limitations:

- When at least one of the following input arguments is a `gpuArray` or a `dLarray` with underlying data of type `gpuArray`, this function runs on the GPU:
  - `dLX`
  - `targets`

For more information, see “Run MATLAB Functions on a GPU” (Parallel Computing Toolbox).

## See Also

`dLarray` | `dlfeval` | `dlgradient` | `mse` | `softmax`

### **Topics**

“Define Custom Training Loops, Loss Functions, and Networks”

“Train Network Using Custom Training Loop”

“Train Network Using Model Function”

“Train Network with Multiple Outputs”



**Introduced in R2019b**

# DAGNetwork

Directed acyclic graph (DAG) network for deep learning

## Description

A DAG network is a neural network for deep learning with layers arranged as a directed acyclic graph. A DAG network can have a more complex architecture in which layers have inputs from multiple layers and outputs to multiple layers.

## Creation

There are several ways to create a DAGNetwork object:

- Load a pretrained network such as `squeezenet`, `googlenet`, `resnet50`, `resnet101`, or `inceptionv3`. For an example, see “Download GoogLeNet Support Package” on page 1-420. For more information about pretrained networks, see “Pretrained Deep Neural Networks”.
- Import a pretrained network from Keras using `importKerasNetwork`. For an example, see “Import and Plot Keras Network” on page 1-493.
- Train or fine-tune a network using `trainNetwork`. For an example, see “Train Deep Learning Network to Classify New Images”.

---

**Note** To learn about other pretrained networks, see “Pretrained Deep Neural Networks”.

---

## Properties

### Layers — Network layers

Layer array

Network layers, specified as a Layer array.

### Connections — Layer connections

table

Layer connections, specified as a table with two columns.

Each table row represents a connection in the layer graph. The first column, `Source`, specifies the source of each connection. The second column, `Destination`, specifies the destination of each connection. The connection sources and destinations are either layer names or have the form `'layerName/IOName'`, where `'IOName'` is the name of the layer input or output.

Data Types: `table`

### InputNames — Network input layer names

cell array

Network input layer names, specified as a cell array of character vectors.

Data Types: cell

### OutputNames — Network output layer names

cell array

Network output layer names, specified as a cell array of character vectors.

Data Types: cell

## Object Functions

activations    Compute deep learning network layer activations  
 classify        Classify data using a trained deep learning neural network  
 predict        Predict responses using a trained deep learning neural network  
 plot            Plot neural network layer graph

## Examples

### Create Simple DAG Network

Create a simple directed acyclic graph (DAG) network for deep learning. Train the network to classify images of digits. The simple network in this example consists of:

- A main branch with layers connected sequentially.
- A *shortcut connection* containing a single 1-by-1 convolutional layer. Shortcut connections enable the parameter gradients to flow more easily from the output layer to the earlier layers of the network.

Create the main branch of the network as a layer array. The addition layer sums multiple inputs element-wise. Specify the number of inputs for the addition layer to sum. All layers must have names and all names must be unique.

```
layers = [
    imageInputLayer([28 28 1], 'Name', 'input')

    convolution2dLayer(5,16, 'Padding', 'same', 'Name', 'conv_1')
    batchNormalizationLayer('Name', 'BN_1')
    reluLayer('Name', 'relu_1')

    convolution2dLayer(3,32, 'Padding', 'same', 'Stride', 2, 'Name', 'conv_2')
    batchNormalizationLayer('Name', 'BN_2')
    reluLayer('Name', 'relu_2')
    convolution2dLayer(3,32, 'Padding', 'same', 'Name', 'conv_3')
    batchNormalizationLayer('Name', 'BN_3')
    reluLayer('Name', 'relu_3')

    additionLayer(2, 'Name', 'add')

    averagePooling2dLayer(2, 'Stride', 2, 'Name', 'avpool')
    fullyConnectedLayer(10, 'Name', 'fc')
    softmaxLayer('Name', 'softmax')
    classificationLayer('Name', 'classOutput')];
```

Create a layer graph from the layer array. `layerGraph` connects all the layers in `layers` sequentially. Plot the layer graph.

```
lgraph = layerGraph(layers);  
figure  
plot(lgraph)
```

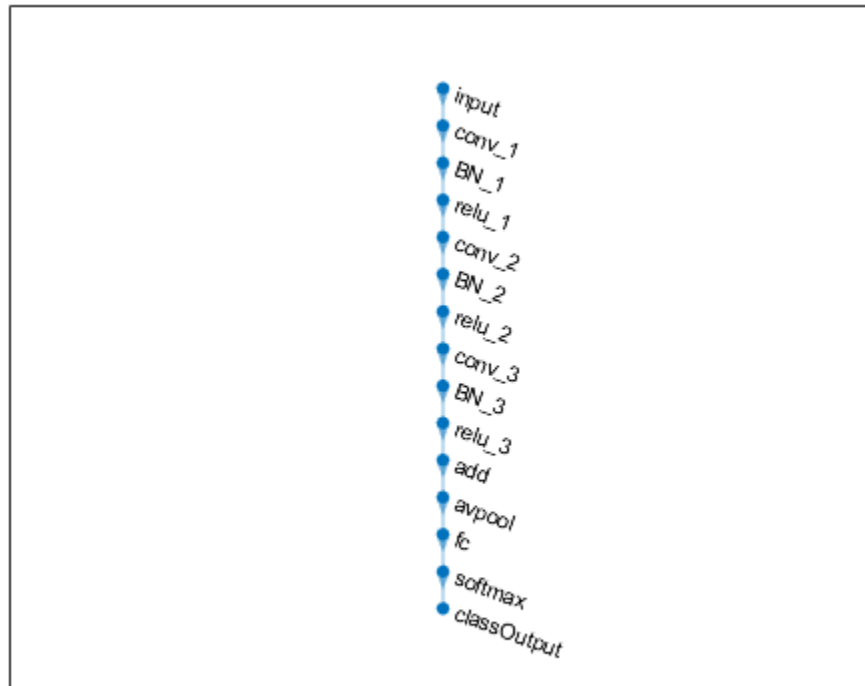

Create the 1-by-1 convolutional layer and add it to the layer graph. Specify the number of convolutional filters and the stride so that the activation size matches the activation size of the 'relu\_3' layer. This arrangement enables the addition layer to add the outputs of the 'skipConv' and 'relu\_3' layers. To check that the layer is in the graph, plot the layer graph.

```
skipConv = convolution2dLayer(1,32,'Stride',2,'Name','skipConv');  
lgraph = addLayers(lgraph,skipConv);  
figure  
plot(lgraph)
```

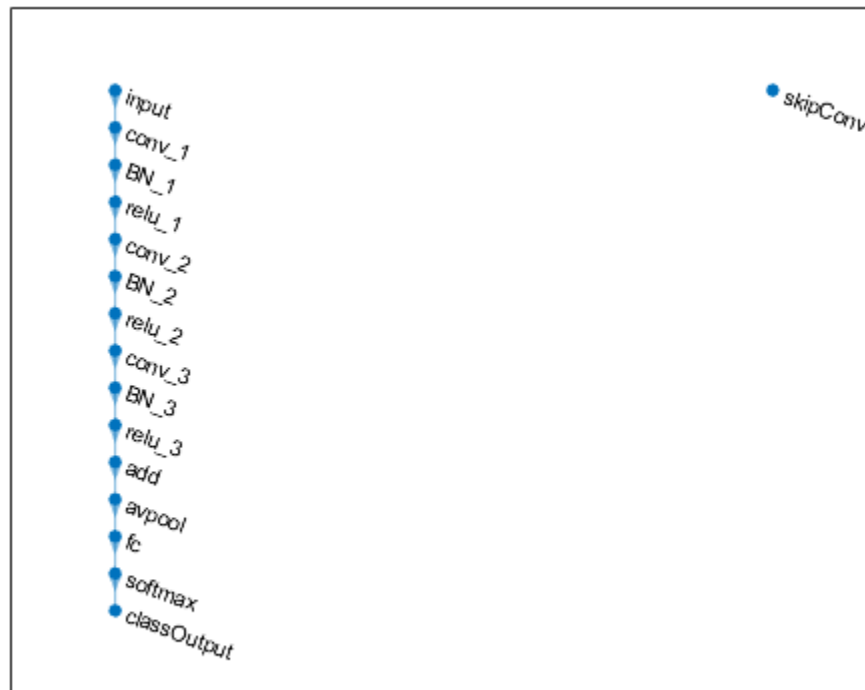

Create the shortcut connection from the 'relu\_1' layer to the 'add' layer. Because you specified two as the number of inputs to the addition layer when you created it, the layer has two inputs named 'in1' and 'in2'. The 'relu\_3' layer is already connected to the 'in1' input. Connect the 'relu\_1' layer to the 'skipConv' layer and the 'skipConv' layer to the 'in2' input of the 'add' layer. The addition layer now sums the outputs of the 'relu\_3' and 'skipConv' layers. To check that the layers are connected correctly, plot the layer graph.

```
lgraph = connectLayers(lgraph, 'relu_1', 'skipConv');
lgraph = connectLayers(lgraph, 'skipConv', 'add/in2');
figure
plot(lgraph);
```

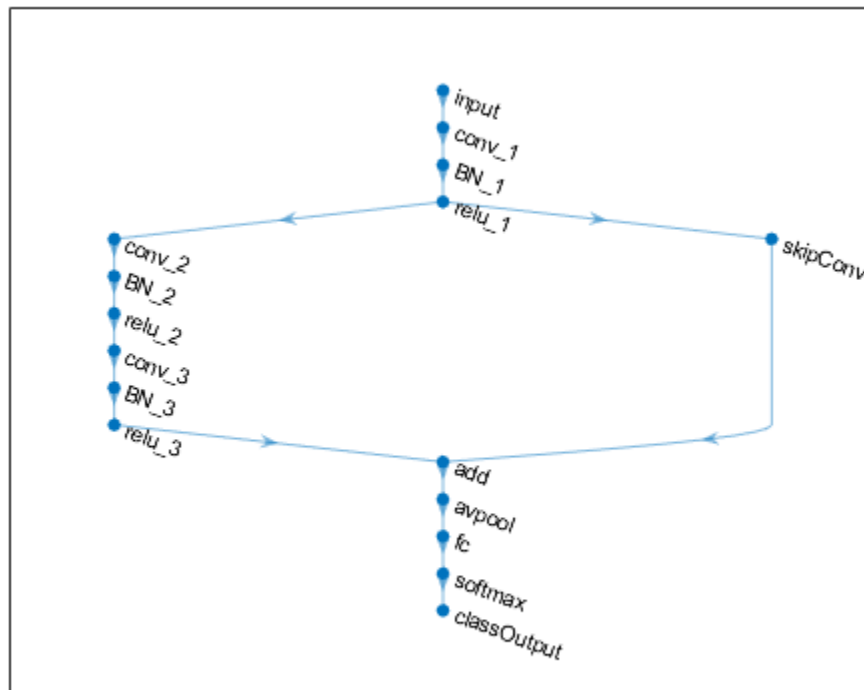

Load the training and validation data, which consists of 28-by-28 grayscale images of digits.

```
[XTrain,YTrain] = digitTrain4DArrayData;
[XValidation,YValidation] = digitTest4DArrayData;
```

Specify training options and train the network. `trainNetwork` validates the network using the validation data every `ValidationFrequency` iterations.

```
options = trainingOptions('sgdm', ...
    'MaxEpochs',8, ...
    'Shuffle','every-epoch', ...
    'ValidationData',{XValidation,YValidation}, ...
    'ValidationFrequency',30, ...
    'Verbose',false, ...
    'Plots','training-progress');
net = trainNetwork(XTrain,YTrain,lgraph,options);
```

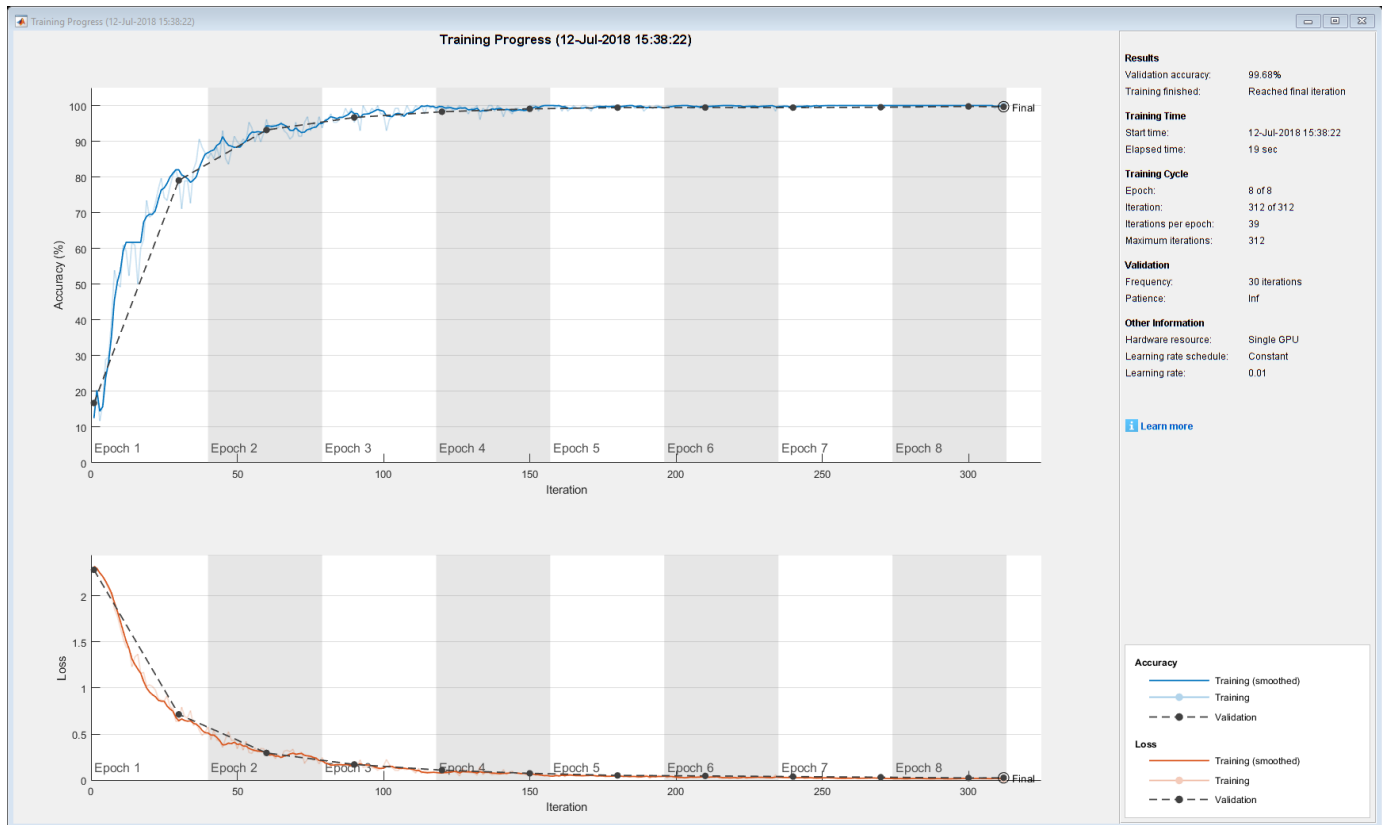

Display the properties of the trained network. The network is a DAGNetwork object.

```
net
```

```
net =
```

```
DAGNetwork with properties:
```

```
Layers: [16x1 nnet.cnn.layer.Layer]
```

```
Connections: [16x2 table]
```

Classify the validation images and calculate the accuracy. The network is very accurate.

```
YPredicted = classify(net,XValidation);
accuracy = mean(YPredicted == YValidation)
```

```
accuracy = 0.9968
```

## Extended Capabilities

### C/C++ Code Generation

Generate C and C++ code using MATLAB® Coder™.

Usage notes and limitations:

- Only the activations and predict object functions are supported.

- To create a `DAGNetwork` object for code generation, see “Load Pretrained Networks for Code Generation” (MATLAB Coder).

## GPU Code Generation

Generate CUDA® code for NVIDIA® GPUs using GPU Coder™.

Usage notes and limitations:

- Only the `activations`, `predict`, and `classify` methods are supported.
- To create a `DAGNetwork` object for code generation, see “Load Pretrained Networks for Code Generation” (GPU Coder).

## See Also

`SeriesNetwork` | `analyzeNetwork` | `assembleNetwork` | `classify` | `googlenet` | `importKerasNetwork` | `inceptionresnetv2` | `inceptionv3` | `layerGraph` | `plot` | `predict` | `resnet101` | `resnet18` | `resnet50` | `squeezenet` | `trainNetwork` | `trainingOptions`

## Topics

“Deep Learning in MATLAB”

“Classify Image Using GoogLeNet”

“Train Residual Network for Image Classification”

“Train Deep Learning Network to Classify New Images”

“Pretrained Deep Neural Networks”

## Introduced in R2017b



# darknet19

DarkNet-19 convolutional neural network

## Syntax

```
net = darknet19
net = darknet19('Weights','imagenet')

layers = darknet19('Weights','none')
```

## Description

DarkNet-19 is a convolutional neural network that is 19 layers deep. You can load a pretrained version of the network trained on more than a million images from the ImageNet database [1]. The pretrained network can classify images into 1000 object categories, such as keyboard, mouse, pencil, and many animals. As a result, the network has learned rich feature representations for a wide range of images. The network has an image input size of 256-by-256. For more pretrained networks in MATLAB, see “Pretrained Deep Neural Networks”.

You can use `classify` to classify new images using the DarkNet-19 model. Follow the steps of “Classify Image Using GoogLeNet” and replace GoogLeNet with DarkNet-19.

To retrain the network on a new classification task, follow the steps of “Train Deep Learning Network to Classify New Images” and load DarkNet-19 instead of GoogLeNet.

DarkNet-19 is often used as the foundation for object detection problems and YOLO workflows [2]. For an example of how to train a you only look once (YOLO) v2 object detector, see “Object Detection Using YOLO v2 Deep Learning”. This example uses ResNet-50 for feature extraction. You can also use other pretrained networks such as DarkNet-19, DarkNet-53, MobileNet-v2, or ResNet-18 depending on application requirements.

`net = darknet19` returns a DarkNet-19 network trained on the ImageNet data set.

This function requires the Deep Learning Toolbox Model *for DarkNet-19 Network* support package. If this support package is not installed, then the function provides a download link.

`net = darknet19('Weights','imagenet')` returns a DarkNet-19 network trained on the ImageNet data set. This syntax is equivalent to `net = darknet19`.

`layers = darknet19('Weights','none')` returns the untrained DarkNet-19 network architecture. The untrained model does not require the support package.

## Examples

### Download DarkNet-19 Support Package

Download and install the Deep Learning Toolbox Model *for DarkNet-19 Network* support package.

Type `darknet19` at the command line.

```
darknet19
```

If the Deep Learning Toolbox Model *for DarkNet-19 Network* support package is not installed, then the function provides a link to the required support package in the Add-On Explorer. To install the support package, click the link, and then click **Install**. Check that the installation is successful by typing `darknet19` at the command line. If the required support package is installed, then the function returns a `SeriesNetwork` object.

```
darknet19
```

```
ans =
```

```
SeriesNetwork with properties:  
    Layers: [64x1 nnet.cnn.layer.Layer]  
    InputNames: {'input'}  
    OutputNames: {'output'}
```

## Transfer Learning with DarkNet-19

You can use transfer learning to retrain the network to classify a new set of images.

Open the example “Train Deep Learning Network to Classify New Images”. The original example uses the GoogLeNet pretrained network. To perform transfer learning using a different network, load your desired pretrained network and follow the steps in the example.

Load the DarkNet-19 network instead of GoogLeNet.

```
net = darknet19
```

Follow the remaining steps in the example to retrain your network. You must replace the last learnable layer and the classification layer in your network with new layers for training. The example shows you how to find which layers to replace.

## Output Arguments

### **net** — Pretrained DarkNet-19 convolutional network

`SeriesNetwork`

Pretrained DarkNet-19 convolutional neural network, returned as a `SeriesNetwork` object.

### **layers** — Untrained DarkNet-19 convolutional neural network architecture

`Layer` array

Untrained DarkNet-19 convolutional neural network architecture, returned as a `Layer` array.

## References

[1] *ImageNet*. <http://www.image-net.org>

[2] Redmon, Joseph. “Darknet: Open Source Neural Networks in C.” <https://pjreddie.com/darknet>.

## Extended Capabilities

### C/C++ Code Generation

Generate C and C++ code using MATLAB® Coder™.

For code generation, you can load the network by using the syntax `net = darknet19` or by passing the `darknet19` function to `coder.loadDeepLearningNetwork`. For example: `net = coder.loadDeepLearningNetwork('darknet19')`.

The syntax `darknet19('Weights', 'none')` is not supported for code generation.

### GPU Code Generation

Generate CUDA® code for NVIDIA® GPUs using GPU Coder™.

Usage notes and limitations:

- For code generation, you can load the network by using the syntax `net = darknet19` or by passing the `darknet19` function to `coder.loadDeepLearningNetwork`. For example: `net = coder.loadDeepLearningNetwork('darknet19')`.

For more information, see “Load Pretrained Networks for Code Generation” (GPU Coder).

- The syntax `darknet19('Weights', 'none')` is not supported for GPU code generation.

## See Also

[SeriesNetwork](#) | [darknet53](#) | [densenet201](#) | [googlenet](#) | [inceptionresnetv2](#) | [layerGraph](#) | [nasnetlarge](#) | [nasnetmobile](#) | [plot](#) | [resnet101](#) | [resnet50](#) | [squeezeNet](#) | [trainNetwork](#) | [vgg16](#) | [vgg19](#)

### Topics

“Deep Learning in MATLAB”

“Pretrained Deep Neural Networks”

“Classify Image Using GoogLeNet”

“Train Deep Learning Network to Classify New Images”

“Train Residual Network for Image Classification”

### Introduced in R2020a

## darknet53

DarkNet-53 convolutional neural network

### Syntax

```
net = darknet53
net = darknet53('Weights','imagenet')

lgraph = darknet53('Weights','none')
```

### Description

DarkNet-53 is a convolutional neural network that is 53 layers deep. You can load a pretrained version of the network trained on more than a million images from the ImageNet database [1]. The pretrained network can classify images into 1000 object categories, such as keyboard, mouse, pencil, and many animals. As a result, the network has learned rich feature representations for a wide range of images. The network has an image input size of 256-by-256. For more pretrained networks in MATLAB, see “Pretrained Deep Neural Networks”.

You can use `classify` to classify new images using the DarkNet-53 model. Follow the steps of “Classify Image Using GoogLeNet” and replace GoogLeNet with DarkNet-53.

To retrain the network on a new classification task, follow the steps of “Train Deep Learning Network to Classify New Images” and load DarkNet-53 instead of GoogLeNet.

DarkNet-53 is often used as the foundation for object detection problems and YOLO workflows [2]. For an example of how to train a you only look once (YOLO) v2 object detector, see “Object Detection Using YOLO v2 Deep Learning”. This example uses ResNet-50 for feature extraction. You can also use other pretrained networks such as DarkNet-19, DarkNet-53, MobileNet-v2, or ResNet-18 depending on application requirements.

`net = darknet53` returns a DarkNet-53 network trained on the ImageNet data set.

This function requires the Deep Learning Toolbox Model *for DarkNet-53 Network* support package. If this support package is not installed, then the function provides a download link.

`net = darknet53('Weights','imagenet')` returns a DarkNet-53 network trained on the ImageNet data set. This syntax is equivalent to `net = darknet53`.

`lgraph = darknet53('Weights','none')` returns the untrained DarkNet-53 network architecture. The untrained model does not require the support package.

### Examples

#### Download DarkNet-53 Support Package

Download and install the Deep Learning Toolbox Model *for DarkNet-53 Network* support package.

Type `darknet53` at the command line.

```
darknet53
```

If the Deep Learning Toolbox Model *for DarkNet-53 Network* support package is not installed, then the function provides a link to the required support package in the Add-On Explorer. To install the support package, click the link, and then click **Install**. Check that the installation is successful by typing `darknet53` at the command line. If the required support package is installed, then the function returns a `DAGNetwork` object.

```
darknet53
```

```
ans =
```

```
DAGNetwork with properties:
    Layers: [184x1 nnet.cnn.layer.Layer]
    Connections: [206x2 table]
    InputNames: {'input'}
    OutputNames: {'output'}
```

## Transfer Learning with DarkNet-53

You can use transfer learning to retrain the network to classify a new set of images.

Open the example “Train Deep Learning Network to Classify New Images”. The original example uses the GoogLeNet pretrained network. To perform transfer learning using a different network, load your desired pretrained network and follow the steps in the example.

Load the DarkNet-53 network instead of GoogLeNet.

```
net = darknet53
```

Follow the remaining steps in the example to retrain your network. You must replace the last learnable layer and the classification layer in your network with new layers for training. The example shows you how to find which layers to replace.

## Output Arguments

### **net** — Pretrained DarkNet-53 convolutional network

`DAGNetwork`

Pretrained DarkNet-53 convolutional neural network, returned as a `DAGNetwork` object.

### **lgraph** — Untrained DarkNet-53 convolutional neural network architecture

`LayerGraph` object

Untrained DarkNet-53 convolutional neural network architecture, returned as a `LayerGraph` object.

## References

[1] *ImageNet*. <http://www.image-net.org>

[2] Redmon, Joseph. “Darknet: Open Source Neural Networks in C.” <https://pjreddie.com/darknet>.

## Extended Capabilities

### C/C++ Code Generation

Generate C and C++ code using MATLAB® Coder™.

Usage notes and limitations:

For code generation, you can load the network by using the syntax `net = darknet53` or by passing the `darknet53` function to `coder.loadDeepLearningNetwork`. For example: `net = coder.loadDeepLearningNetwork('darknet53')`

The syntax `darknet53('Weights', 'none')` is not supported for code generation.

### GPU Code Generation

Generate CUDA® code for NVIDIA® GPUs using GPU Coder™.

Usage notes and limitations:

- For code generation, you can load the network by using the syntax `net = darknet53` or by passing the `darknet53` function to `coder.loadDeepLearningNetwork`. For example: `net = coder.loadDeepLearningNetwork('darknet53')`.

For more information, see “Load Pretrained Networks for Code Generation” (GPU Coder).

- The syntax `darknet53('Weights', 'none')` is not supported for GPU code generation.

## See Also

[DAGNetwork](#) | [darknet19](#) | [densenet201](#) | [googlenet](#) | [inceptionresnetv2](#) | [layerGraph](#) | [nasnetlarge](#) | [nasnetmobile](#) | [plot](#) | [resnet101](#) | [resnet50](#) | [squeezeNet](#) | [trainNetwork](#) | [vgg16](#) | [vgg19](#)

## Topics

“Deep Learning in MATLAB”

“Pretrained Deep Neural Networks”

“Classify Image Using GoogLeNet”

“Train Deep Learning Network to Classify New Images”

“Train Residual Network for Image Classification”

## Introduced in R2020a

# deepDreamImage

Visualize network features using deep dream

## Syntax

```
I = deepDreamImage(net,layer,channels)
I = deepDreamImage(net,layer,channels,Name,Value)
```

## Description

`I = deepDreamImage(net,layer,channels)` returns an array of images that strongly activate the channels `channels` within the network `net` of the layer with numeric index or name given by `layer`. These images highlight the features learned by a network.

`I = deepDreamImage(net,layer,channels,Name,Value)` returns an image with additional options specified by one or more `Name,Value` pair arguments.

## Examples

### Visualize Convolutional Neural Network Features

Load a pretrained AlexNet network.

```
net = alexnet;
```

Visualize the first 25 features learned by the first convolutional layer ('conv1') using `deepDreamImage`. Set 'PyramidLevels' to 1 so that the images are not scaled.

```
layer = 'conv1';
channels = 1:25;

I = deepDreamImage(net,layer,channels, ...
    'PyramidLevels',1, ...
    'Verbose',0);

figure
for i = 1:25
    subplot(5,5,i)
    imshow(I(:,:,i))
end
```

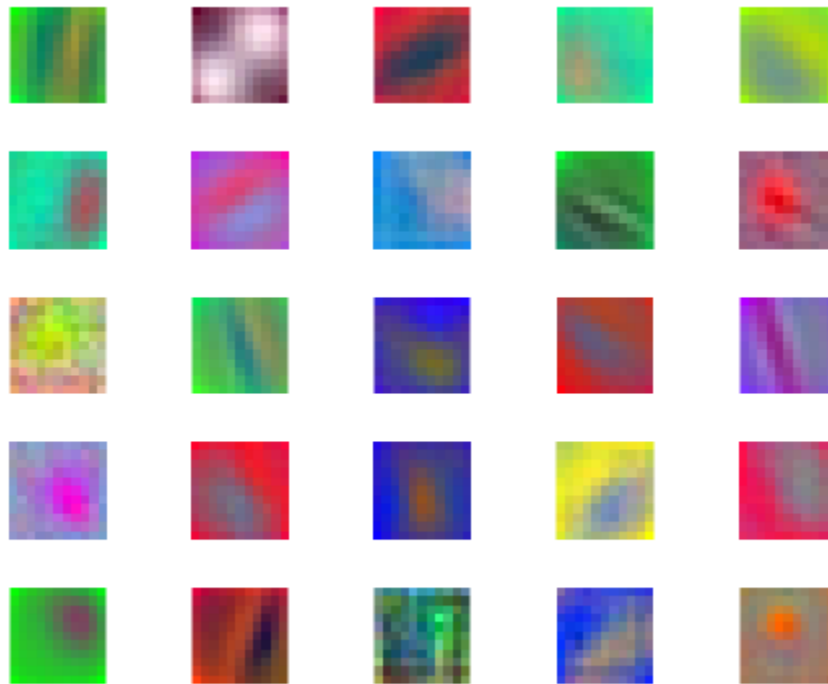

## Input Arguments

### **net** — Trained network

SeriesNetwork object | DAGNetwork object

Trained network, specified as a SeriesNetwork object or a DAGNetwork object. You can get a trained network by importing a pretrained network or by training your own network using the trainNetwork function. For more information about pretrained networks, see “Pretrained Deep Neural Networks”.

deepDreamImage only supports networks with an image input layer.

### **layer** — Layer index or name

positive integer | character vector | string scalar

Layer to visualize, specified as a positive integer, a character vector, or a string scalar. If net is a DAGNetwork object, specify layer as a character vector or string scalar only. Specify layer as the index or the name of the layer you want to visualize the activations of. To visualize classification layer features, select the last fully connected layer before the classification layer.

---

**Tip** Selecting ReLU or dropout layers for visualization may not produce useful images because of the effect that these layers have on the network gradients.

---



**channels — Channel index**

numeric index | vector of numeric indices

Queried channels, specified as scalar or vector of channel indices. If `channels` is a vector, the layer activations for each channel are optimized independently. The possible choices for `channels` depend on the selected layer. For convolutional layers, the `NumFilters` property specifies the number of output channels. For fully connected layers, the `OutputSize` property specifies the number of output channels.

**Name-Value Pair Arguments**

Specify optional comma-separated pairs of `Name`, `Value` arguments. `Name` is the argument name and `Value` is the corresponding value. `Name` must appear inside quotes. You can specify several name and value pair arguments in any order as `Name1, Value1, ..., NameN, ValueN`.

Example:

```
deepDreamImage(net, layer, channels, 'NumIterations', 100, 'ExecutionEnvironment', 'gpu') generates images using 100 iterations per pyramid level and uses the GPU.
```

**InitialImage — Image to initialize Deep Dream**

array

Image to initialize Deep Dream. Use this syntax to see how an image is modified to maximize network layer activations. The minimum height and width of the initial image depend on all the layers up to and including the selected layer:

- For layers towards the end of the network, the initial image must be at least the same height and width as the image input layer.
- For layers towards the beginning of the network, the height and width of the initial image can be smaller than the image input layer. However, it must be large enough to produce a scalar output at the selected layer.
- The number of channels of the initial image must match the number of channels in the image input layer of the network.

If you do not specify an initial image, the software uses a random image with pixels drawn from a standard normal distribution. See also 'PyramidLevels' on page 1-0 .

**PyramidLevels — Number of pyramid levels**

3 (default) | positive integer

Number of multi-resolution image pyramid levels to use to generate the output image, specified as a positive integer. Increase the number of pyramid levels to produce larger output images at the expense of additional computation. To produce an image of the same size as the initial image, set the number of levels to 1.

Example: 'PyramidLevels', 3

**PyramidScale — Scale between pyramid levels**

1.4 (default) | scalar with value &gt; 1

Scale between each pyramid level, specified as a scalar with value > 1. Reduce the pyramid scale to incorporate fine grain details into the output image. Adjusting the pyramid scale can help generate more informative images for layers at the beginning of the network.

Example: 'PyramidScale', 1.4

**NumIterations — Number of iterations per pyramid level**

10 (default) | positive integer

Number of iterations per pyramid level, specified as a positive integer. Increase the number of iterations to produce more detailed images at the expense of additional computation.

Example: 'NumIterations',10

**OutputScaling — Type of scaling to apply to output**

'linear' (default) | 'none'

Type of scaling to apply to output image, specified as the comma-separated pair consisting of 'OutputScaling' and one of the following:

Value	Description
'linear'	Scale output pixel values in the interval [0,1]. The output image corresponding to each layer channel, $I(:, :, :, channel)$ , is scaled independently.
'none'	Disable output scaling.

Scaling the pixel values can cause the network to misclassify the output image. If you want to classify the output image, set the 'OutputScaling' value to 'none'.

Example: 'OutputScaling','linear'

**Verbose — Indicator to display progress information**

1 (default) | 0

Indicator to display progress information in the command window, specified as the comma-separated pair consisting of 'Verbose' and either 1 (true) or 0 (false). The displayed information includes the pyramid level, iteration, and the activation strength.

Example: 'Verbose',0

Data Types: logical

**ExecutionEnvironment — Hardware resource**

'auto' (default) | 'gpu' | 'cpu'

Hardware resource, specified as the comma-separated pair consisting of 'ExecutionEnvironment' and one of the following:

- 'auto' — Use a GPU if one is available; otherwise, use the CPU.
- 'gpu' — Use the GPU. Using a GPU requires Parallel Computing Toolbox and a CUDA enabled NVIDIA GPU with compute capability 3.0 or higher. If Parallel Computing Toolbox or a suitable GPU is not available, then the software returns an error.
- 'cpu' — Use the CPU.

Example: 'ExecutionEnvironment','cpu'

**Output Arguments**

**I — Output image**

array

Output image, specified by a sequence of grayscale or truecolor (RGB) images stored in a 4-D array. Images are concatenated along the fourth dimension of  $I$  such that the image that maximizes the output of `channels(k)` is  $I(:, :, :, k)$ . You can display the output image using `imshow`.

## Algorithms

This function implements a version of deep dream that uses a multi-resolution image pyramid and Laplacian Pyramid Gradient Normalization to generate high-resolution images. For more information on Laplacian Pyramid Gradient Normalization, see this blog post: [DeepDreaming with TensorFlow](#).

All functions for deep learning training, prediction, and validation in Deep Learning Toolbox perform computations using single-precision, floating-point arithmetic. Functions for deep learning include `trainNetwork`, `predict`, `classify`, and `activations`. The software uses single-precision arithmetic when you train networks using both CPUs and GPUs.

## References

[1] *DeepDreaming with TensorFlow*. <https://github.com/tensorflow/tensorflow/blob/master/tensorflow/examples/tutorials/deepdream/deepdream.ipynb>

## See Also

`activations` | `alexnet` | `googlenet` | `squeezenet` | `vgg16` | `vgg19`

## Topics

“Deep Learning in MATLAB”

“Pretrained Deep Neural Networks”

“Deep Dream Images Using GoogLeNet”

“Visualize Features of a Convolutional Neural Network”

“Visualize Activations of a Convolutional Neural Network”

“Visualize Activations of LSTM Network”

## Introduced in R2017a

## densenet201

DenseNet-201 convolutional neural network

### Syntax

```
net = densenet201
net = densenet201('Weights','imagenet')

lgraph = densenet201('Weights','none')
```

### Description

DenseNet-201 is a convolutional neural network that is 201 layers deep. You can load a pretrained version of the network trained on more than a million images from the ImageNet database [1]. The pretrained network can classify images into 1000 object categories, such as keyboard, mouse, pencil, and many animals. As a result, the network has learned rich feature representations for a wide range of images. The network has an image input size of 224-by-224. For more pretrained networks in MATLAB, see “Pretrained Deep Neural Networks”.

You can use `classify` to classify new images using the DenseNet-201 model. Follow the steps of “Classify Image Using GoogLeNet” and replace GoogLeNet with DenseNet-201.

To retrain the network on a new classification task, follow the steps of “Train Deep Learning Network to Classify New Images” and load DenseNet-201 instead of GoogLeNet.

`net = densenet201` returns a DenseNet-201 network trained on the ImageNet data set.

This function requires the Deep Learning Toolbox Model for DenseNet-201 Network support package. If this support package is not installed, then the function provides a download link.

`net = densenet201('Weights','imagenet')` returns a DenseNet-201 network trained on the ImageNet data set. This syntax is equivalent to `net = densenet201`.

`lgraph = densenet201('Weights','none')` returns the untrained DenseNet-201 network architecture. The untrained model does not require the support package.

### Examples

#### Download DenseNet-201 Support Package

Download and install the Deep Learning Toolbox Model *for DenseNet-201 Network* support package.

Type `densenet201` at the command line.

```
densenet201
```

If the Deep Learning Toolbox Model *for DenseNet-201 Network* support package is not installed, then the function provides a link to the required support package in the Add-On Explorer. To install the support package, click the link, and then click **Install**. Check that the installation is successful by

typing `densenet201` at the command line. If the required support package is installed, then the function returns a `DAGNetwork` object.

```
densenet201
ans =
    DAGNetwork with properties:
        Layers: [709x1 nnet.cnn.layer.Layer]
        Connections: [806x2 table]
```

## Output Arguments

### **net** — Pretrained DenseNet-201 convolutional neural network

`DAGNetwork` object

Pretrained DenseNet-201 convolutional neural network, returned as a `DAGNetwork` object.

### **lgraph** — Untrained DenseNet-201 convolutional neural network architecture

`LayerGraph` object

Untrained DenseNet-201 convolutional neural network architecture, returned as a `LayerGraph` object.

## References

[1] *ImageNet*. <http://www.image-net.org>

[2] Huang, Gao, Zhuang Liu, Laurens Van Der Maaten, and Kilian Q. Weinberger. "Densely Connected Convolutional Networks." In *CVPR*, vol. 1, no. 2, p. 3. 2017.

## Extended Capabilities

### **C/C++ Code Generation**

Generate C and C++ code using MATLAB® Coder™.

For code generation, you can load the network by using the syntax `net = densenet201` or by passing the `densenet201` function to `coder.loadDeepLearningNetwork`. For example: `net = coder.loadDeepLearningNetwork('densenet201')`

For more information, see “Load Pretrained Networks for Code Generation” (MATLAB Coder).

The syntax `densenet201('Weights','none')` is not supported for code generation.

### **GPU Code Generation**

Generate CUDA® code for NVIDIA® GPUs using GPU Coder™.

Usage notes and limitations:

- For code generation, you can load the network by using the syntax `net = densenet201` or by passing the `densenet201` function to `coder.loadDeepLearningNetwork`. For example: `net = coder.loadDeepLearningNetwork('densenet201')`.

For more information, see “Load Pretrained Networks for Code Generation” (GPU Coder).

- The syntax `densenet201('Weights','none')` is not supported for GPU code generation.

## See Also

[DAGNetwork](#) | [alexnet](#) | [googlenet](#) | [inceptionresnetv2](#) | [inceptionv3](#) | [layerGraph](#) | [plot](#) | [resnet101](#) | [resnet18](#) | [resnet50](#) | [squeezeNet](#) | [trainNetwork](#) | [vgg16](#) | [vgg19](#)

## Topics

“Deep Learning in MATLAB”

“Pretrained Deep Neural Networks”

“Classify Image Using GoogLeNet”

“Train Deep Learning Network to Classify New Images”

“Train Residual Network for Image Classification”

## Introduced in R2018a

# depthConcatenationLayer

Depth concatenation layer

## Description

A depth concatenation layer takes inputs that have the same height and width and concatenates them along the third dimension (the channel dimension).

Specify the number of inputs to the layer when you create it. The inputs have the names 'in1', 'in2', ..., 'inN', where N is the number of inputs. Use the input names when connecting or disconnecting the layer by using `connectLayers` or `disconnectLayers`.

## Creation

### Syntax

```
layer = depthConcatenationLayer(numInputs)
layer = depthConcatenationLayer(numInputs, 'Name', name)
```

### Description

`layer = depthConcatenationLayer(numInputs)` creates a depth concatenation layer that concatenates `numInputs` inputs along the third (channel) dimension. This function also sets the `NumInputs` property.

`layer = depthConcatenationLayer(numInputs, 'Name', name)` also sets the `Name` property. To create a network containing a depth concatenation layer, you must specify a layer name.

## Properties

### NumInputs — Number of inputs

positive integer

Number of inputs to the layer, specified as a positive integer.

The inputs have the names 'in1', 'in2', ..., 'inN', where N equals `NumInputs`. For example, if `NumInputs` equals 3, then the inputs have the names 'in1', 'in2', and 'in3'. Use the input names when connecting or disconnecting the layer by using `connectLayers` or `disconnectLayers`.

### Name — Layer name

' ' (default) | character vector | string scalar

Layer name, specified as a character vector or a string scalar. To include this layer in a layer graph, you must specify a layer name.

Data Types: char | string

**InputNames — Input Names**`{'in1','in2',..., 'inN'}` (default)

Input names, specified as `{'in1','in2',..., 'inN'}`, where N is the number of inputs of the layer.

Data Types: `cell`

**NumOutputs — Number of outputs**`1` (default)

Number of outputs of the layer. This layer has a single output only.

Data Types: `double`

**OutputNames — Output names**`{'out'}` (default)

Output names of the layer. This layer has a single output only.

Data Types: `cell`

## Examples

**Create and Connect Depth Concatenation Layer**

Create a depth concatenation layer with two inputs and the name `'concat_1'`.

```
concat = depthConcatenationLayer(2, 'Name', 'concat_1')
```

```
concat =  
    DepthConcatenationLayer with properties:
```

```
        Name: 'concat_1'  
    NumInputs: 2  
    InputNames: {'in1' 'in2'}
```

Create two ReLU layers and connect them to the depth concatenation layer. The depth concatenation layer concatenates the outputs from the ReLU layers.

```
relu_1 = reluLayer('Name', 'relu_1');  
relu_2 = reluLayer('Name', 'relu_2');
```

```
lgraph = layerGraph;  
lgraph = addLayers(lgraph, relu_1);  
lgraph = addLayers(lgraph, relu_2);  
lgraph = addLayers(lgraph, concat);
```

```
lgraph = connectLayers(lgraph, 'relu_1', 'concat_1/in1');  
lgraph = connectLayers(lgraph, 'relu_2', 'concat_1/in2');
```

```
plot(lgraph)
```



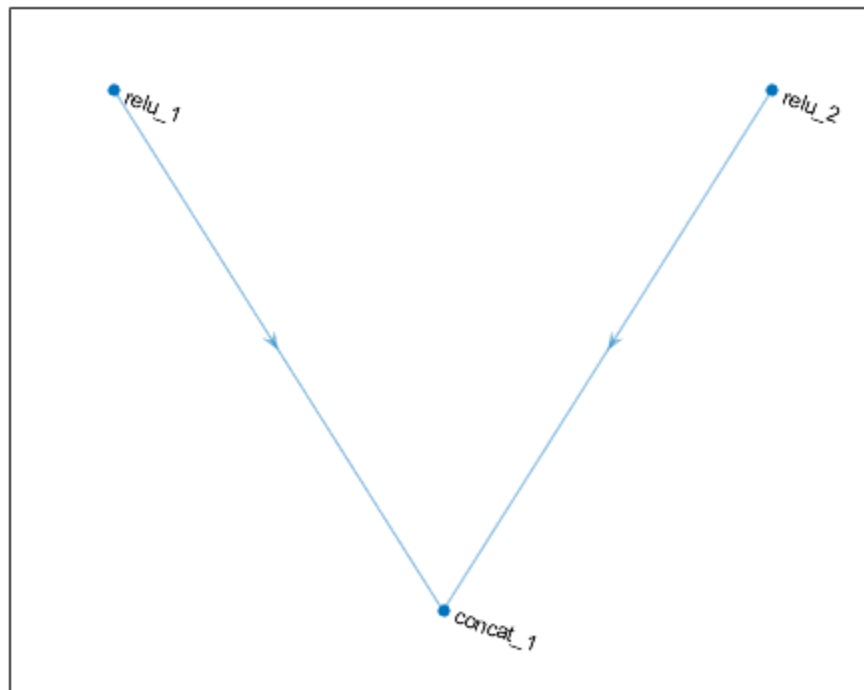

## Extended Capabilities

### GPU Code Generation

Generate CUDA® code for NVIDIA® GPUs using GPU Coder™.

### See Also

[additionLayer](#) | [connectLayers](#) | [disconnectLayers](#) | [layerGraph](#) | [trainNetwork](#)

### Topics

“Create Simple Deep Learning Network for Classification”  
“Deep Learning in MATLAB”  
“Pretrained Deep Neural Networks”  
“Set Up Parameters and Train Convolutional Neural Network”  
“Specify Layers of Convolutional Neural Network”  
“Train Residual Network for Image Classification”  
“List of Deep Learning Layers”

**Introduced in R2017b**

## dims

Dimension labels of `dLarray`

### Syntax

```
d = dims(dLX)
```

### Description

`d = dims(dLX)` returns the labels of `dLX` as a character array.

### Examples

#### Obtain Dimension Labels

Obtain the dimension labels of a `dLarray`.

```
dLX = dLarray(randn(3,4), 'TS');  
d = dims(dLX)
```

```
d =  
'ST'
```

Obtain the labels of an unlabeled `dLarray`.

```
y = stripdims(dLX);  
d = dims(y)
```

```
d =
```

```
0x0 empty char array
```

### Input Arguments

#### **dLX** — Input `dLarray`

`dLarray` object

Input `dLarray`, specified as a `dLarray` object.

Example: `dLX = dLarray(randn(3,4), 'ST')`

### Output Arguments

#### **d** — Dimension labels

character vector

Dimension labels, returned as a character vector. If the input `dLX` is unlabeled, `d` is empty.

## **See Also**

`dlarray` | `finddim` | `stripdims`

**Introduced in R2019b**

# dlarray

Deep learning array for custom training loops

## Description

A deep learning array stores data with optional data format labels for custom training loops, and enables functions to compute and use derivatives through automatic differentiation.

---

**Tip** For most deep learning tasks, you can use a pretrained network and adapt it to your own data. For an example showing how to use transfer learning to retrain a convolutional neural network to classify a new set of images, see “Train Deep Learning Network to Classify New Images”. Alternatively, you can create and train networks from scratch using `layerGraph` objects with the `trainNetwork` and `trainingOptions` functions.

If the `trainingOptions` function does not provide the training options that you need for your task, then you can create a custom training loop using automatic differentiation. To learn more, see “Define Custom Training Loops”.

---

## Creation

### Syntax

```
dlX = dlarray(X)
dlX = dlarray(X,fmt)
dlX = dlarray(v,dim)
```

### Description

`dlX = dlarray(X)` returns a `dlarray` object representing `X`. If `X` is a `dlarray`, `dlX` is a copy of `X`.

`dlX = dlarray(X,fmt)` labels the data in `dlX` according to the data format in `fmt`. Labels help in passing deep learning data between functions. See “Usage” on page 1-292. If `X` is a labeled `dlarray`, then `fmt` replaces the existing labels.

`dlX = dlarray(v,dim)` accepts a vector `v` and a single character format `dim`, and returns a column vector `dlarray`. The first dimension of `dlX` has the label `dim`, and the second (singleton) dimension has the label 'U'.

### Input Arguments

#### **X — Data array**

numeric array of data type `double` or `single` | logical array | `gpuArray` object | `dlarray` object

Data array, specified as a numeric array of data type `double` or `single`, logical array, `gpuArray` object, or `dlarray` object. `X` must be full, not sparse, and must be real, not complex.

Example: `rand(31*23,23)`

**fmt — Data format**

character vector | string scalar

Data format, specified as a character vector or string scalar. Each character in `fmt` must be one of these labels:

- S — Spatial
- C — Channel
- B — Batch observations
- T — Time or sequence
- U — Unspecified

You can specify any number of S and U labels. You can specify at most one of each of the C, B, and T labels.

Each element of `fmt` labels the matching dimension of `dLX`. If `fmt` is not in the listed order ('S' followed by 'C' and so on), then `dlarray` implicitly permutes both `fmt` and the data to match the order, but without changing the storage of the data.

`fmt` must have at least the same number of labels as the number of dimensions of `dLX`. If you specify more than that number of labels, `dlarray` creates empty (singleton) dimensions for the additional labels.

For information on `fmt`, see "Usage" on page 1-292.

Example: "SSB"

Example: 'CBUSS', which `dlarray` reorders to 'SSCBU'

**v — Data vector**numeric vector of data type double or single | logical vector | `dlarray` vector object

Data vector, specified as a numeric vector of data type double or single, logical vector, `gpuArray` vector object, or `dlarray` vector object. Here, "vector" means any array with exactly one nonsingleton dimension.

Example: `rand(100,1)`

**dim — Dimension label**

single character

Dimension label, specified as a single character of the type allowed for `fmt`.

Example: "S"

Example: 'S'

**Output Arguments****dLX — Deep learning array**`dlarray` object

Deep learning array, returned as a `dlarray` object. `dLX` enables automatic differentiation using `dlgradient` and `dlfeval`. If you supply the `fmt` argument, `dLX` has labels.

- If X is a numeric or logical array, d\X contains its data, possibly reordered because of labels in fmt.
- If X is a gpuArray, the data in d\X is also on the GPU. Subsequent calculations using d\X are performed on the GPU.

## Usage

d\array labels enable you to use the functions in this table to execute with assurance that the data has the appropriate format.

Function	Operation	Validates Input Dimension	Affects Size of Input Dimension
avgpool	Compute the average of the input data over moving rectangular (or cuboidal) spatial ('S') regions defined by a pool size parameter.	'S'	'S'
batchnorm	Normalize the values contained in each channel ('C') of the input data.	'C'	
crossentropy	Compute the cross-entropy between estimates and target values, averaged by the size of the batch ('B') dimension.	'S', 'C', 'B', 'T', 'U' (Estimates and target arrays must have the same sizes.)	'S', 'C', 'B', 'T', 'U' (The output is an unlabeled scalar.)
dlconv	Compute the deep learning convolution of the input data using an array of filters, matching the number of spatial ('S') and (a function of the) channel ('C') dimensions of the input, and adding a constant bias.	'S', 'C'	'S', 'C'
dltranspconv	Compute the deep learning transposed convolution of the input data using an array of filters, matching the number of spatial ('S') and (a function of the) channel ('C') dimensions of the input, and adding a constant bias.	'S', 'C'	'S', 'C'
fullyconnect	Compute a weighted sum of the input data and apply a bias for each batch ('B') and time ('T') dimension.	'S', 'C', 'U'	'S', 'C', 'B', 'T', 'U' (The output always has labels 'CB', 'CT', or 'CTB'.)
gru	Apply a gated recurrent unit calculation to the input data.	'S', 'C', 'T'	'C'

Function	Operation	Validates Input Dimension	Affects Size of Input Dimension
lstm	Apply a long short-term memory calculation to the input data.	'S', 'C', 'T'	'C'
maxpool	Compute the maximum of the input data over moving rectangular spatial ('S') regions defined by a pool size parameter.	'S'	'S'
maxunpool	Compute the unpooling operation over the spatial ('S') dimensions.	'S'	'S'
mse	Compute the half mean squared error between estimates and target values, averaged by the size of the batch ('B') dimension.	'S', 'C', 'B', 'T', 'U' (Estimates and target arrays must have the same sizes.)	'S', 'C', 'B', 'T', 'U' (The output is an unlabeled scalar.)
softmax	Apply the softmax activation to each channel ('C') of the input data.	'C'	

These functions require each dimension to have a label, specified either as the labels of their first `dlarray` input, or as the 'DataFormat' name-value pair argument containing dimension labels.

`dlarray` enforces the order of labels 'SCBTU'. This enforcement eliminates ambiguous semantics in operations, which implicitly match labels between inputs. `dlarray` also enforces that the labels 'C', 'B', and 'T' can each appear at most once. The functions that use these labels accept at most one dimension for each label.

`dlarray` provides functions for removing labels (`stripdims`), obtaining the dimensions associated with labels (`finddim`), and listing the labels associated with a `dlarray` (`dims`).

For more information on how a `dlarray` behaves with labels, see “Notable `dlarray` Behaviors”.

## Object Functions

<code>avgpool</code>	Pool data to average values over spatial dimensions
<code>batchnorm</code>	Normalize each channel of input data
<code>crossentropy</code>	Cross-entropy loss for classification tasks
<code>dims</code>	Dimension labels of <code>dlarray</code>
<code>dlconv</code>	Deep learning convolution
<code>dlgradient</code>	Compute gradients for custom training loops using automatic differentiation
<code>dltransconv</code>	Deep learning transposed convolution
<code>extractdata</code>	Extract data from <code>dlarray</code>
<code>finddim</code>	Find dimensions with specified label
<code>fullyconnect</code>	Sum all weighted input data and apply a bias
<code>gru</code>	Gated recurrent unit
<code>leakyrelu</code>	Apply leaky rectified linear unit activation
<code>lstm</code>	Long short-term memory

maxpool	Pool data to maximum value
maxunpool	Unpool the output of a maximum pooling operation
mse	Half mean squared error
relu	Apply rectified linear unit activation
sigmoid	Apply sigmoid activation
softmax	Apply softmax activation to channel dimension
stripdims	Remove dlarray labels

A `dlarray` also allows functions for numeric, matrix, and other operations. See the full list in “List of Functions with `dlarray` Support”.

## Examples

### Create Unlabeled `dlarray`

Create an unlabeled `dlarray` from a matrix.

```
rng default % For reproducibility
X = randn(3,5);
dlX = dlarray(X)

dlX =
    3x5 dlarray

    0.5377    0.8622   -0.4336    2.7694    0.7254
    1.8339    0.3188    0.3426   -1.3499   -0.0631
   -2.2588   -1.3077    3.5784    3.0349    0.7147
```

### Create Labeled `dlarray`

Create a `dlarray` that has a data format with the labels 'S' and 'C'.

```
rng default % For reproducibility
X = randn(3,5);
dlX = dlarray(X, 'SC')

dlX =
    3(S) × 5(C) dlarray

    0.5377    0.8622   -0.4336    2.7694    0.7254
    1.8339    0.3188    0.3426   -1.3499   -0.0631
   -2.2588   -1.3077    3.5784    3.0349    0.7147
```

If you specify the labels in the opposite order, `dlarray` implicitly reorders the underlying data.

```
dlX = dlarray(X, 'CS')

dlX =
    5(S) × 3(C) dlarray

    0.5377    1.8339   -2.2588
```



```

0.8622    0.3188   -1.3077
-0.4336   0.3426    3.5784
2.7694   -1.3499    3.0349
0.7254   -0.0631    0.7147

```

## Create Labeled dlarray Vector

Create a `dlarray` vector with the first label 'T'. The second label, which `dlarray` creates automatically, is 'U'.

```

rng default % For reproducibility
X = randn(6,1);
dlX = dlarray(X, 'T')

```

```

dlX =
    6(T) x 1(U) dlarray

    0.5377
    1.8339
   -2.2588
    0.8622
    0.3188
   -1.3077

```

If you specify a row vector for `X`, `dlarray` implicitly reorders the result to be a column vector.

```

X = X';
dlX = dlarray(X, 'T')

```

```

dlX =
    6(T) x 1(U) dlarray

    0.5377
    1.8339
   -2.2588
    0.8622
    0.3188
   -1.3077

```

## Tips

- A `dlgradient` call must be inside a function. To obtain a numeric value of a gradient, you must evaluate the function using `dlfeval`, and the argument to the function must be a `dlarray`. See “Use Automatic Differentiation In Deep Learning Toolbox”.
- To enable the correct evaluation of gradients, `dlfeval` must call functions that use only supported functions for `dlarray`. See “List of Functions with `dlarray` Support”.

## See Also

`dims` | `dlfeval` | `dlgradient` | `dlnetwork` | `finddim` | `stripdims`

**Topics**

- "Train Generative Adversarial Network (GAN)"
- "Grad-CAM Reveals the Why Behind Deep Learning Decisions"
- "Define Custom Training Loops, Loss Functions, and Networks"
- "Automatic Differentiation Background"
- "Use Automatic Differentiation In Deep Learning Toolbox"
- "List of Functions with dlarray Support"

**Introduced in R2019b**

# dlconv

Deep learning convolution

## Syntax

```
dLY = dlconv(dlX,weights,bias)
dLY = dlconv(dlX,weights,bias,'DataFormat',FMT)
dLY = dlconv( ___ Name,Value)
```

## Description

The convolution operation applies sliding filters to the input data. Use 1-D and 2-D filters with ungrouped or grouped convolutions and 3-D filters with ungrouped convolutions.

Use grouped convolution for channel-wise separable (also known as depth-wise separable) convolution. For each group, the operation convolves the input by moving filters along spatial dimensions of the input data, computing the dot product of the weights and the data and adding a bias. If the number of groups is equal to the number of channels, then this function performs channel-wise convolution. If the number of groups is equal to 1, this function performs ungrouped convolution.

---

**Note** This function applies the deep learning convolution operation to `dLarray` data. If you want to apply convolution within a `layerGraph` object or `Layer` array, use one of the following layers:

- `convolution2dLayer`
  - `groupedConvolution2dLayer`
  - `convolution3dLayer`
- 

`dLY = dlconv(dlX,weights,bias)` computes the deep learning convolution of the input `dlX` using sliding convolutional filters defined by `weights`, and adds a constant `bias`. The input `dlX` is a formatted `dLarray` with dimension labels. Convolution acts on dimensions that you specify as 'S' dimensions. The output `dLY` is a formatted `dLarray` with the same dimension labels as `dlX`.

`dLY = dlconv(dlX,weights,bias,'DataFormat',FMT)` also specifies dimension format `FMT` when `dlX` is not a formatted `dLarray`. The output `dLY` is an unformatted `dLarray` with the same dimension order as `dlX`.

`dLY = dlconv( ___ Name,Value)` specifies options using one or more name-value pair arguments in addition to the input arguments in previous syntaxes. For example, `'Stride',3` sets the stride of the convolution operation.

## Examples

### Perform Ungrouped Convolution

Convolve all channels of an image input using a single filter.

Import the image data and convert it to a `dlarray`.

```
X = imread('sherlock.jpg');  
dlX = dlarray(single(X), 'SSC');
```

Display the image.

```
imshow(X, 'DisplayRange', [])
```



Initialize the convolutional filters. Specify an ungrouped convolution that applies a single filter to all three channels of the input data.

```
filterHeight = 10;  
filterWidth = 10;  
numChannelsPerGroup = 3;  
numFiltersPerGroup = 1;  
numGroups = 1;
```

```
weights = rand(filterHeight,filterWidth,numChannelsPerGroup,numFiltersPerGroup,numGroups);
```

Initialize the bias term.

```
bias = rand(numFiltersPerGroup*numGroups,1);
```

Perform the convolution. Use a 'Stride' value of 2 and a 'DilationFactor' value of 2.

```
dlY = dlconv(dlX,weights,bias,'Stride',2,'DilationFactor',2);
```

Display the convolved image.

```
Y = extractdata(dLY);  
imshow(Y, 'DisplayRange', [])
```



### Perform Grouped Convolution

Convolve the input data in three groups of two channels each. Apply four filters per group.

Create the input data as 10 observations of size 100-by-100 with six channels.

```
height = 100;  
width = 100;  
channels = 6;  
numObservations = 10;  
  
X = rand(height,width,channels,numObservations);  
dLX = dlarray(X, 'SSCB');
```

Initialize the convolutional filters. Specify three groups of convolutions that each apply four convolution filters to two channels of the input data.

```
filterHeight = 8;  
filterWidth = 8;  
numChannelsPerGroup = 2;  
numFiltersPerGroup = 4;
```

```
numGroups = 3;
weights = rand(filterHeight,filterWidth,numChannelsPerGroup,numFiltersPerGroup,numGroups);
```

Initialize the bias term.

```
bias = rand(numFiltersPerGroup*numGroups,1);
```

Perform the convolution.

```
dLY = dlconv(dlX,weights,bias);
size(dLY)
```

```
ans = 1×4
```

```
    93    93    12    10
```

```
dims(dLY)
```

```
ans =
'SSCB'
```

The 12 channels of the convolution output represent the three groups of convolutions with four filters per group.

### **Perform Channel-Wise Separable Convolution**

Separate the input data into channels and perform convolution on each channel separately.

Create the input data as a single observation with a size of 64-by-64 and 10 channels. Create the data as an unformatted `dlarray`.

```
height = 64;
width = 64;
channels = 10;
```

```
X = rand(height,width,channels);
dlX = dlarray(X);
```

Initialize the convolutional filters. Specify an ungrouped convolution that applies a single convolution to all three channels of the input data.

```
filterHeight = 8;
filterWidth = 8;
numChannelsPerGroup = 1;
numFiltersPerGroup = 1;
numGroups = channels;
```

```
weights = rand(filterHeight,filterWidth,numChannelsPerGroup,numFiltersPerGroup,numGroups);
```

Initialize the bias term.

```
bias = rand(numFiltersPerGroup*numGroups,1);
```

Perform the convolution. Specify the dimension labels of the input data using the 'DataFormat' option.

```
dLY = dlconv(dLX,weights,bias,'DataFormat','SSC');
size(dLY)
```

```
ans = 1×3
```

```
    57    57    10
```

Each channel is convolved separately, so there are 10 channels in the output.

## Input Arguments

### dLX — Input data

dlarray | numeric array

Input data, specified as a dlarray with or without dimension labels or a numeric array. When dLX is not a formatted dlarray, you must specify the dimension label format using 'DataFormat', FMT. If dLX is a numeric array, at least one of weights or bias must be a dlarray.

Convolution acts on dimensions that you specify as spatial dimensions using the 'S' dimension label. You can specify up to three dimensions in dLX as 'S' dimensions.

Data Types: single | double

### weights — Convolutional filters

dlarray | numeric array

Convolutional filters, specified as a dlarray with or without labels or a numeric array. The weights argument specifies the size and values of the filters, as well as the number of filters and the number of groups for grouped convolutions.

Specify weights as a filterSize-by-numChannelsPerGroup-by-numFiltersPerGroup-by-numGroups array.

- filterSize — Size of the convolutional filters. filterSize can have up to three dimensions, depending on the number of spatial dimensions in the input data.

Input Data 'S' Dimensions	filterSize
1-D	$h$ , where $h$ corresponds to the height of the filter
2-D	$h$ -by- $w$ , where $h$ and $w$ correspond to the height and width of the filter, respectively
3-D	$h$ -by- $w$ -by- $d$ , where $h$ , $w$ , and $d$ correspond to the height, width, and depth of the filter, respectively

- numChannelsPerGroup — Number of channels to convolve within each group. numChannelsPerGroup must equal the number of channels in the input data divided by numGroups, the number of groups. For ungrouped convolutions, where numGroups = 1, numChannelsPerGroup must equal the number of channels in the input data.

- `numFiltersPerGroup` — Number of filters to apply within each group.
- `numGroups` — Number of groups (optional). When `numGroups > 1`, the function performs grouped convolutions. Grouped convolutions are not supported for input data with more than two 'S' dimensions. When `numGroups = 1`, the function performs ungrouped convolutions; in this case, this dimension is singleton and can be omitted.

If `weights` is a formatted `darray`, it can have multiple spatial dimensions labeled 'S', one channel dimension labeled 'C', and up to two other dimensions labeled 'U'. The number of 'S' dimensions must match the number of 'S' dimensions of the input data. The labeled dimensions correspond to the filter specifications as follows.

Filter Specification	Dimension Labels
<code>filterSize</code>	Up to three 'S' dimensions
<code>numChannelsPerGroup</code>	'C' dimension
<code>numFiltersPerGroup</code>	First 'U' dimension
<code>numGroups</code> (optional)	Second 'U' dimension

Data Types: `single` | `double`

**bias — Bias constant**

`darray vector` | `darray scalar` | `numeric vector` | `numeric scalar` | `0`

Bias constant, specified as a `darray vector` or `darray scalar` with or without labels, a numeric vector, or a numeric scalar.

- If `bias` is a scalar or has only singleton dimensions, the same bias is applied to each output.
- If `bias` has a nonsingleton dimension, each element of `bias` is the bias applied to the corresponding convolutional filter specified by `weights`. The number of elements of `bias` must match the number of filters specified by `weights`.
- If `bias` is a scalar numeric array with value `0`, the bias term is disabled and no bias is added during the convolution operation.

If `bias` is a formatted `darray`, the nonsingleton dimension must be a channel dimension labeled 'C'.

Data Types: `single` | `double`

**Name-Value Pair Arguments**

Specify optional comma-separated pairs of `Name, Value` arguments. `Name` is the argument name and `Value` is the corresponding value. `Name` must appear inside quotes. You can specify several name and value pair arguments in any order as `Name1, Value1, ..., NameN, ValueN`.

Example: `'DilationFactor', 2` sets the dilation factor for each convolutional filter to 2.

**DataFormat — Dimension order of unformatted data**

`char array` | `string`

Dimension order of unformatted input data, specified as the comma-separated pair consisting of 'DataFormat' and a character array or string `FMT` that provides a label for each dimension of the data. Each character in `FMT` must be one of the following:



- 'S' — Spatial
- 'C' — Channel
- 'B' — Batch (for example, samples and observations)
- 'T' — Time (for example, sequences)
- 'U' — Unspecified

You can specify multiple dimensions labeled 'S' or 'U'. You can use the labels 'C', 'B', and 'T' at most once.

You must specify 'DataFormat' when the input data `dLX` is not a formatted `dLarray`.

Example: 'DataFormat', 'SSCB'

Data Types: `char` | `string`

### **Stride — Step size for traversing input data**

1 (default) | numeric scalar | numeric vector

Step size for traversing the input data, specified as the comma-separated pair consisting of 'Stride' and a numeric scalar or numeric vector. If you specify 'Stride' as a scalar, the same value is used for all spatial dimensions. If you specify 'Stride' as a vector of the same size as the number of spatial dimensions of the input data, the vector values are used for the corresponding spatial dimensions.

The default value of 'Stride' is 1.

Example: 'Stride', 3

Data Types: `single` | `double`

### **DilationFactor — Filter dilation factor**

1 (default) | numeric scalar | numeric vector

Filter dilation factor, specified as the comma-separated pair consisting of 'DilationFactor' and one of the following.

- Numeric scalar — The same dilation factor value is applied for all spatial dimensions.
- Numeric vector — A different dilation factor value is applied along each spatial dimension. Use a vector of size `d`, where `d` is the number of spatial dimensions of the input data. The `i`th element of the vector specifies the dilation factor applied to the `i`th spatial dimension.

Use the dilation factor to increase the receptive field of the filter (the area of the input that the filter can see) on the input data. Using a dilation factor corresponds to an effective filter size of  $\text{filterSize} + (\text{filterSize}-1) * (\text{dilationFactor}-1)$ .

Example: 'DilationFactor', 2

Data Types: `single` | `double`

### **Padding — Padding applied to edges of data**

0 (default) | 'same' | numeric scalar | numeric vector | numeric matrix

Padding applied to edges of data, specified as the comma-separated pair consisting of 'Padding' and one of the following:

- 'same' — Padding is set so that the output size is the same as the input size when the stride is 1. More generally, the output size of each spatial dimension is `ceil(inputSize/stride)`, where `inputSize` is the size of the input along a spatial dimension.
- Numeric scalar — The same padding value is applied to both ends of all spatial dimensions.
- Numeric vector — A different padding value is applied along each spatial dimension. Use a vector of size `d`, where `d` is the number of spatial dimensions of the input data. The `i`th element of the vector specifies the padding applied to the start and the end along the `i`th spatial dimension.
- Numeric matrix — A different padding value is applied to the start and end of each spatial dimension. Use a matrix of size 2-by-`d`, where `d` is the number of spatial dimensions of the input data. The element `(1, d)` specifies the padding applied to the start of spatial dimension `d`. The element `(2, d)` specifies the padding applied to the end of spatial dimension `d`. For example, in 2-D, the format is `[top, left; bottom, right]`.

The default value of 'Padding' is 0.

Example: 'Padding', 'same'

Data Types: `single` | `double`

## Output Arguments

### **dLY — Convolved feature map**

`dLarray`

Convolved feature map, returned as a `dLarray`. The output `dLY` has the same underlying data type as the input `dLX`.

If the input data `dLX` is a formatted `dLarray`, `dLY` has the same dimension labels as `dLX`. If the input data is not a formatted `dLarray`, `dLY` is an unformatted `dLarray` with the same dimension order as the input data.

The size of the 'C' channel dimension of `dLY` depends on the size of the `weights` input. The size of the 'C' dimension of output `Y` is the product of the size of the dimensions `numFiltersPerGroup` and `numGroups` in the `weights` argument. If `weights` is a formatted `dLarray`, this product is the same as the product of the size of the 'U' dimensions.

## More About

### **Deep Learning Convolution**

The `dLconv` function applies sliding convolution filters to the spatial dimensions of the input data. The `dLconv` function supports convolution in one, two, or three spatial dimensions. For more information, see the definition of convolutional layer on page 1-224 on the `convolution2dLayer` reference page.

## Extended Capabilities

### **GPU Arrays**

Accelerate code by running on a graphics processing unit (GPU) using Parallel Computing Toolbox™.

Usage notes and limitations:

- When at least one of the following input arguments is a `gpuArray` or a `dLarray` with underlying data of type `gpuArray`, this function runs on the GPU.
  - `dLX`
  - `weights`
  - `bias`

For more information, see “Run MATLAB Functions on a GPU” (Parallel Computing Toolbox).

### **See Also**

`batchnorm` | `dLarray` | `dLfeval` | `dLgradient` | `fullyconnect` | `maxpool` | `relu`

### **Topics**

“Define Custom Training Loops, Loss Functions, and Networks”  
“Train Network Using Model Function”

**Introduced in R2019b**

## dlfeval

Evaluate deep learning model for custom training loops

### Syntax

```
[y1,...,yk] = dlfeval(fun,x1,...,xn)
```

### Description

Use `dlfeval` to evaluate custom deep learning models for custom training loops.

---

**Tip** For most deep learning tasks, you can use a pretrained network and adapt it to your own data. For an example showing how to use transfer learning to retrain a convolutional neural network to classify a new set of images, see “Train Deep Learning Network to Classify New Images”. Alternatively, you can create and train networks from scratch using `layerGraph` objects with the `trainNetwork` and `trainingOptions` functions.

If the `trainingOptions` function does not provide the training options that you need for your task, then you can create a custom training loop using automatic differentiation. To learn more, see “Define Custom Training Loops”.

---

`[y1,...,yk] = dlfeval(fun,x1,...,xn)` evaluates the deep learning array function `fun` at the input arguments `x1,...,xn`. Functions passed to `dlfeval` can contain calls to `dlgradient`, which compute gradients from the inputs `x` by using automatic differentiation.

### Examples

#### Compute Gradient Using Automatic Differentiation

Rosenbrock's function is a standard test function for optimization. The `rosenbrock.m` helper function computes the function value and uses automatic differentiation to compute its gradient.

```
type rosenbrock.m
```

```
function [y,dydx] = rosenbrock(x)

y = 100*(x(2) - x(1).^2).^2 + (1 - x(1)).^2;
dydx = dlgradient(y,x);

end
```

To evaluate Rosenbrock's function and its gradient at the point  $[-1, 2]$ , create a `dlarray` of the point and then call `dlfeval` on the function handle `@rosenbrock`.

```
x0 = dlarray([-1,2]);
[fval,gradval] = dlfeval(@rosenbrock,x0)

fval =
    1×1 dlarray
```

```

104

gradval =
  1x2 dlarray

    396    200

```

Alternatively, define Rosenbrock's function as a function of two inputs,  $x_1$  and  $x_2$ .

```

type rosenbrock2.m

function [y,dydx1,dydx2] = rosenbrock2(x1,x2)

y = 100*(x2 - x1.^2).^2 + (1 - x1).^2;
[dydx1,dydx2] = dlgradient(y,x1,x2);

end

```

Call `dlfeval` to evaluate `rosenbrock2` on two `dlarray` arguments representing the inputs `-1` and `2`.

```

x1 = dlarray(-1);
x2 = dlarray(2);
[fval,dydx1,dydx2] = dlfeval(@rosenbrock2,x1,x2)

fval =
  1x1 dlarray

    104

dydx1 =
  1x1 dlarray

    396

dydx2 =
  1x1 dlarray

    200

```

Plot the gradient of Rosenbrock's function for several points in the unit square. First, initialize the arrays representing the evaluation points and the output of the function.

```

[X1 X2] = meshgrid(linspace(0,1,10));
X1 = dlarray(X1(:));
X2 = dlarray(X2(:));
Y = dlarray(zeros(size(X1)));
DYDX1 = Y;
DYDX2 = Y;

```

Evaluate the function in a loop. Plot the result using `quiver`.

```

for i = 1:length(X1)
    [Y(i),DYDX1(i),DYDX2(i)] = dlfeval(@rosenbrock2,X1(i),X2(i));

```

```

end
quiver(extractdata(X1),extractdata(X2),extractdata(DYDX1),extractdata(DYDX2))
xlabel('x1')
ylabel('x2')

```

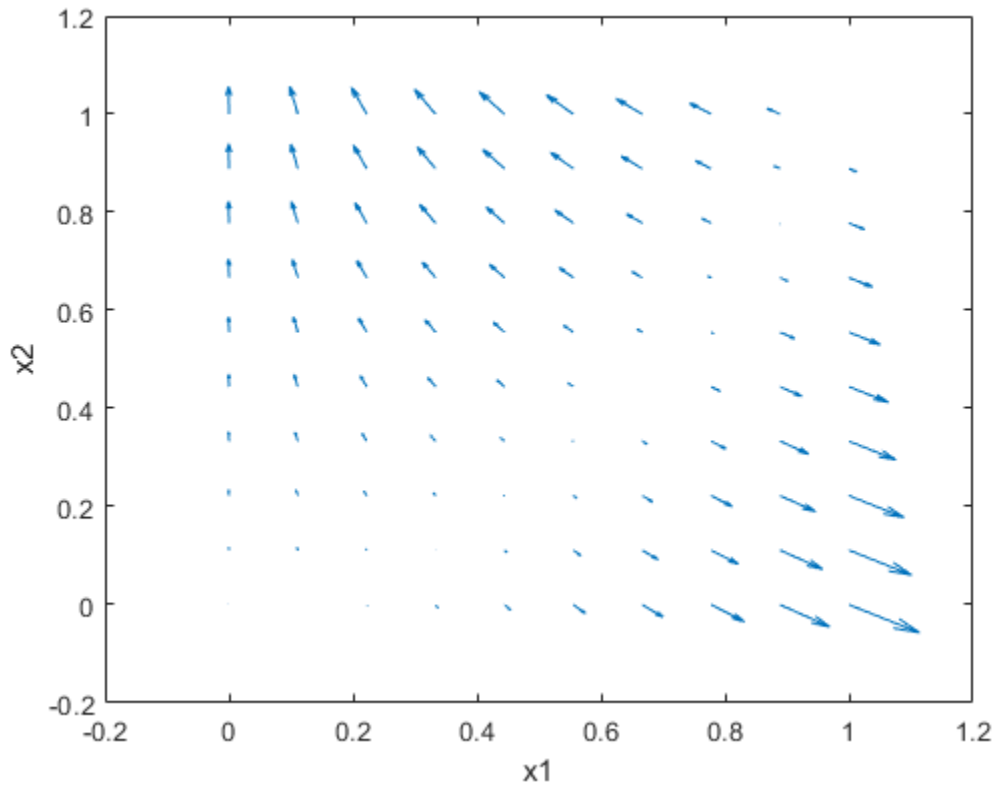

## Input Arguments

### **fun** — Function to evaluate

function handle

Function to evaluate, specified as a function handle. If `fun` includes a `dlgradient` call, then `dlfeval` evaluates the gradient by using automatic differentiation. In this gradient evaluation, each argument of the `dlgradient` call must be a `dlarray` or a cell array, structure, or table containing a `dlarray`. The number of input arguments to `dlfeval` must be the same as the number of input arguments to `fun`.

Example: `@rosenbrock`

Data Types: `function_handle`

### **x** — Function argument

any MATLAB data type

Function argument, specified as any MATLAB data type.

An input argument `xj` that is a variable of differentiation in a `dlgradient` call must be a traced `dlarray` or a cell array, structure, or table containing a traced `dlarray`. An extra variable such as a hyperparameter or constant data array does not have to be a `dlarray`.

Example: `dlarray([1 2;3 4])`

Data Types: `single` | `double` | `int8` | `int16` | `int32` | `int64` | `uint8` | `uint16` | `uint32` | `uint64` | `logical` | `char` | `string` | `struct` | `table` | `cell` | `function_handle` | `categorical` | `datetime` | `duration` | `calendarDuration` | `fi`

## Output Arguments

### **y** — Function output

any data type | `dlarray`

Function output, returned as any data type. If the output results from a `dlgradient` call, the output is a `dlarray`.

## Tips

- A `dlgradient` call must be inside a function. To obtain a numeric value of a gradient, you must evaluate the function using `dlfeval`, and the argument to the function must be a `dlarray`. See “Use Automatic Differentiation In Deep Learning Toolbox”.
- `dlgradient` does not support higher order derivatives. In other words, you cannot pass the output of a `dlgradient` call into another `dlgradient` call.
- To enable the correct evaluation of gradients, the function `fun` must use only supported functions for `dlarray`. See “List of Functions with `dlarray` Support”.

## See Also

`dlarray` | `dlgradient`

### Topics

“Automatic Differentiation Background”

“Use Automatic Differentiation In Deep Learning Toolbox”

“List of Functions with `dlarray` Support”

“Define Custom Training Loops, Loss Functions, and Networks”

“Train Generative Adversarial Network (GAN)”

“Grad-CAM Reveals the Why Behind Deep Learning Decisions”

### Introduced in R2019b

## dlgradient

Compute gradients for custom training loops using automatic differentiation

### Syntax

```
[dydx1,...,dydxk] = dlgradient(y,x1,...,xk)
[dydx1,...,dydxk] = dlgradient(y,x1,...,xk,'RetainData',true)
```

### Description

Use `dlgradient` to compute derivatives using automatic differentiation for custom training loops.

---

**Tip** For most deep learning tasks, you can use a pretrained network and adapt it to your own data. For an example showing how to use transfer learning to retrain a convolutional neural network to classify a new set of images, see “Train Deep Learning Network to Classify New Images”. Alternatively, you can create and train networks from scratch using `layerGraph` objects with the `trainNetwork` and `trainingOptions` functions.

If the `trainingOptions` function does not provide the training options that you need for your task, then you can create a custom training loop using automatic differentiation. To learn more, see “Define Custom Training Loops”.

---

`[dydx1,...,dydxk] = dlgradient(y,x1,...,xk)` returns the gradients of `y` with respect to the variables `x1` through `xk`.

Call `dlgradient` from inside a function passed to `dlfeval`. See “Compute Gradient Using Automatic Differentiation” on page 1-310 and “Use Automatic Differentiation In Deep Learning Toolbox”.

`[dydx1,...,dydxk] = dlgradient(y,x1,...,xk,'RetainData',true)` causes the gradient to retain intermediate values for reuse in subsequent `dlgradient` calls. This syntax can save time, but uses more memory. See “Tips” on page 1-313.

### Examples

#### Compute Gradient Using Automatic Differentiation

Rosenbrock's function is a standard test function for optimization. The `rosenbrock.m` helper function computes the function value and uses automatic differentiation to compute its gradient.

```
type rosenbrock.m

function [y,dydx] = rosenbrock(x)

y = 100*(x(2) - x(1).^2).^2 + (1 - x(1)).^2;
dydx = dlgradient(y,x);

end
```



To evaluate Rosenbrock's function and its gradient at the point  $[-1, 2]$ , create a `dlarray` of the point and then call `dlfeval` on the function handle `@rosenbrock`.

```
x0 = dlarray([-1,2]);
[fval,gradval] = dlfeval(@rosenbrock,x0)

fval =
    1×1 dlarray
    104

gradval =
    1×2 dlarray
    396    200
```

Alternatively, define Rosenbrock's function as a function of two inputs, `x1` and `x2`.

```
type rosenbrock2.m

function [y,dydx1,dydx2] = rosenbrock2(x1,x2)

y = 100*(x2 - x1.^2).^2 + (1 - x1).^2;
[dydx1,dydx2] = dlgradient(y,x1,x2);

end
```

Call `dlfeval` to evaluate `rosenbrock2` on two `dlarray` arguments representing the inputs  $-1$  and  $2$ .

```
x1 = dlarray(-1);
x2 = dlarray(2);
[fval,dydx1,dydx2] = dlfeval(@rosenbrock2,x1,x2)

fval =
    1×1 dlarray
    104

dydx1 =
    1×1 dlarray
    396

dydx2 =
    1×1 dlarray
    200
```

Plot the gradient of Rosenbrock's function for several points in the unit square. First, initialize the arrays representing the evaluation points and the output of the function.

```
[X1 X2] = meshgrid(linspace(0,1,10));
X1 = dlarray(X1(:));
```

```

X2 = dlarray(X2(:));
Y = dlarray(zeros(size(X1)));
DYDX1 = Y;
DYDX2 = Y;

```

Evaluate the function in a loop. Plot the result using `quiver`.

```

for i = 1:length(X1)
    [Y(i),DYDX1(i),DYDX2(i)] = dlfeval(@rosenbrock2,X1(i),X2(i));
end
quiver(extractdata(X1),extractdata(X2),extractdata(DYDX1),extractdata(DYDX2))
xlabel('x1')
ylabel('x2')

```

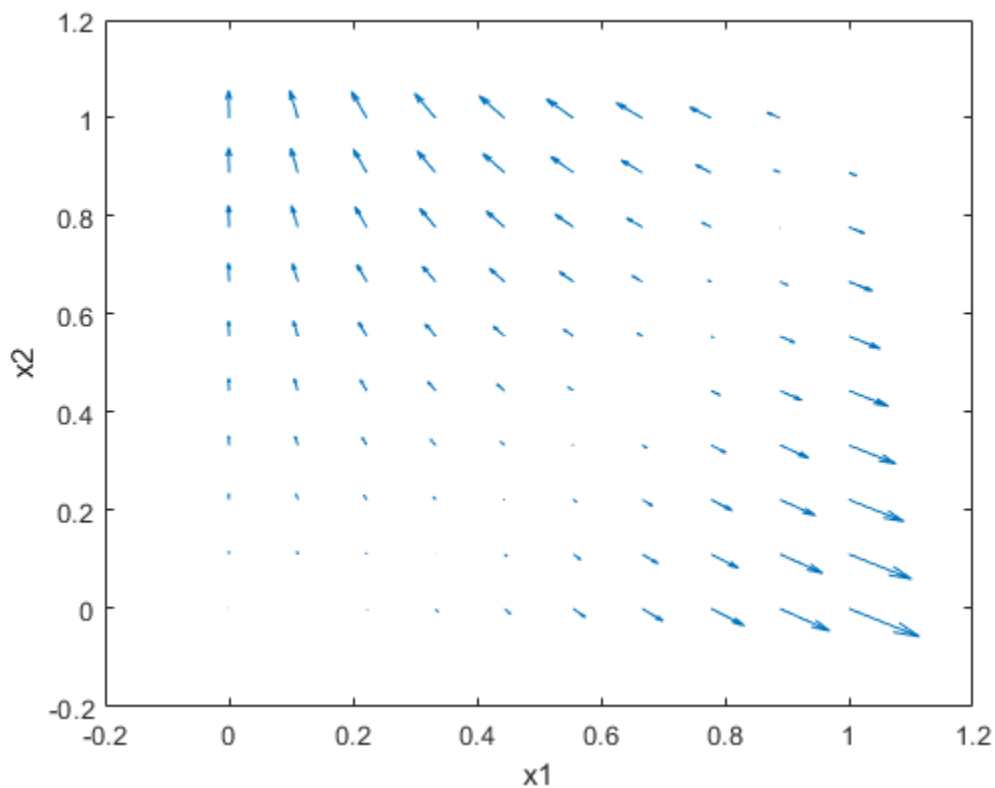

## Input Arguments

### **y** – Variable to differentiate

scalar `dlarray` object

Variable to differentiate, specified as a scalar `dlarray` object. For differentiation, `y` must be a traced function of `dlarray` inputs (see “Traced `dlarray`” on page 1-313) and must consist of supported functions for `dlarray` (see “List of Functions with `dlarray` Support”).

Example: `100*(x(2) - x(1).^2).^2 + (1 - x(1)).^2`

Example: `relu(X)`

**x1, ..., xk — Variable in function**

dlarray object | cell array containing dlarray objects | structure containing dlarray objects | table containing dlarray objects

Variable in the function, specified as a dlarray object, a cell array, structure, or table containing dlarray objects, or any combination of such arguments recursively. For example, an argument can be a cell array containing a cell array that contains a structure containing dlarray objects.

If you specify  $x_1, \dots, x_k$  as a table, the table must contain the following variables:

- **Layer** — Layer name, specified as a string scalar.
- **Parameter** — Parameter name, specified as a string scalar.
- **Value** — Value of parameter, specified as a cell array containing a dlarray.

Example: `dlarray([1 2;3 4])`

Data Types: `single` | `double` | `logical` | `struct` | `cell`

**'RetainData' — Indicator for retaining trace data during function call**

`false` (default) | `true`

Indicator for retaining trace data during the function call, specified as `false` or `true`. When this argument is `false`, a dlarray discards the derivative trace immediately after computing a derivative. When this argument is `true`, a dlarray retains the derivative trace until the end of the `dlfeval` function call that evaluates the `dlgradient`. The `true` setting is useful only when the `dlfeval` call contains more than one `dlgradient` call. The `true` setting causes the software to use more memory, but can save time when multiple `dlgradient` calls use at least part of the same trace.

Example: `dydx = dlgradient(y,x,'RetainData',true)`

Data Types: `logical`

**Output Arguments****dydx1, ..., dydxk — Gradient**

dlarray object | cell array containing dlarray objects | structure containing dlarray objects | table containing dlarray objects

Gradient, returned as a dlarray object, or a cell array, structure, or table containing dlarray objects, or any combination of such arguments recursively. The size and data type of `dydx1, \dots, dydxk` are the same as those of the associated input variable  $x_1, \dots, x_k$ .

**More About****Traced dlarray**

During the computation of a function, a dlarray internally records the steps taken in a trace, enabling reverse mode automatic differentiation. The trace occurs within a `dlfeval` call. See “Automatic Differentiation Background”.

**Tips**

- `dlgradient` does not support higher order derivatives. In other words, you cannot pass the output of a `dlgradient` call into another `dlgradient` call.

- A `dlgradient` call must be inside a function. To obtain a numeric value of a gradient, you must evaluate the function using `dlfeval`, and the argument to the function must be a `dlarray`. See “Use Automatic Differentiation In Deep Learning Toolbox”.
- To enable the correct evaluation of gradients, the `y` argument must use only supported functions for `dlarray`. See “List of Functions with `dlarray` Support”.
- If you set the `'RetainData'` name-value pair argument to `true`, the software preserves tracing for the duration of the `dlfeval` function call instead of erasing the trace immediately after the derivative computation. This preservation can cause a subsequent `dlgradient` call within the same `dlfeval` call to be executed faster, but uses more memory. For example, in training an adversarial network, the `'RetainData'` setting is useful because the two networks share data and functions during training. See “Train Generative Adversarial Network (GAN)”.

## See Also

`dlarray` | `dlfeval`

### Topics

“Define Custom Training Loops, Loss Functions, and Networks”

“Automatic Differentiation Background”

“Use Automatic Differentiation In Deep Learning Toolbox”

“List of Functions with `dlarray` Support”

“Train Generative Adversarial Network (GAN)”

“Grad-CAM Reveals the Why Behind Deep Learning Decisions”

### Introduced in R2019b

# dlmtimes

Batch matrix multiplication for deep learning

## Syntax

```
d1C = dlmtimes(d1A,d1B)
```

## Description

`d1C = dlmtimes(d1A,d1B)` computes matrix multiplication for each page of `d1A` and `d1B`. For 3-D inputs `d1A` and `d1B`, `d1C` is calculated as

$$d1C(:,:,i) = d1A(:,:,i) * d1B(:,:,i)$$

Similarly, for n-dimensional inputs `d1A` and `d1B`, `d1C` is calculated as

$$d1C(:,:,i1,\dots,in) = d1A(:,:,i1,\dots,in) * d1B(:,:,i1,\dots,in)$$

If one of `d1A` or `d1B` is a two-dimensional matrix, this matrix multiplies each page of the other input.

## Examples

### Multiply Two 4-D Arrays

Create two 4-D arrays.

```
A = rand(3,4,8,2);
B = rand(4,5,8,2);
```

```
d1A = dlarray(A);
d1B = dlarray(B);
```

Calculate the batch matrix multiplication of `d1A` and `d1B`.

```
d1C = dlmtimes(d1A,d1B);
size(d1C)
```

```
ans = 1×4
      3   5   8   2
```

### Multiply Two Inputs Using Scalar Expansion

If one of the inputs is a 2-D matrix, the function uses scalar expansion to expand this matrix to the same size as the other input in the third and higher dimensions. The function then performs batch matrix multiplication to the expanded matrix and the input array.

Create a random array of size 15-by-20-by-3-by-128. Convert to `dlarray`.

```
A = rand(15,20,3,128);
d1A = dlarray(A);
```

Create a random matrix of size 20-by-15.

```
B = rand(20,15);
```

Multiply d1A and B using dlmtimes.

```
d1C = dlmtimes(d1A,B);  
size(d1C)
```

```
ans = 1×4  
      15    15     3   128
```

## Input Arguments

### d1A, d1B — Operands

scalars | vectors | matrices | arrays

Operands, specified as scalars, vectors, matrices, or N-D arrays. At least one of d1A or d1B must be a dlarray. The inputs d1A or d1B must not be formatted unless one of d1A or d1B is an unformatted scalar.

The number of columns of d1A must match the number of rows of d1B. If one of d1A or d1B is a two-dimensional matrix, this matrix multiplies each page of the other input. Otherwise, the size of d1A and d1B for each dimension greater than two must match.

## Output Arguments

### d1C — Product

scalar | vector | matrix | array

Product, returned as a scalar, vector, matrix, or an N-D array.

Array d1C has the same number of rows as input d1A and the same number of columns as input d1B, unless one of d1A or d1B is a scalar. The size of the other dimensions of d1C match the size of the dimensions greater than two of both d1A and d1B. If d1A or d1B is a matrix, the size of the other dimensions matches the size of the other (non-matrix) input. If one of d1A or d1B is a scalar, d1C has the same size as the non-scalar input.

## See Also

dlarray | mtimes | pagefun

### Topics

“Sequence-to-Sequence Translation Using Attention”

“Automatic Differentiation Background”

“Use Automatic Differentiation In Deep Learning Toolbox”

“List of Functions with dlarray Support”

### Introduced in R2020a

# dlnetwork

Deep learning network for custom training loops

## Description

A `dlnetwork` object enables support for custom training loops using automatic differentiation.

---

**Tip** For most deep learning tasks, you can use a pretrained network and adapt it to your own data. For an example showing how to use transfer learning to retrain a convolutional neural network to classify a new set of images, see “Train Deep Learning Network to Classify New Images”. Alternatively, you can create and train networks from scratch using `layerGraph` objects with the `trainNetwork` and `trainingOptions` functions.

If the `trainingOptions` function does not provide the training options that you need for your task, then you can create a custom training loop using automatic differentiation. To learn more, see “Define Custom Training Loops”.

---

## Creation

### Syntax

```
dlnet = dlnetwork(lgraph)
```

### Description

`dlnet = dlnetwork(lgraph)` converts a layer graph to a `dlnetwork` object representing a deep neural network for custom training loops.

### Input Arguments

#### **lgraph** — Network architecture

layerGraph object

Network architecture, specified as a layer graph.

The layer graph must not contain output layers. When training the network, calculate the loss separately.

For a list of layers supported by `dlnetwork`, see “Supported Layers” on page 1-324.

## Properties

#### **Layers** — Network layers

Layer array

Network layers, specified as a Layer array.

**Connections — Layer connections**

table

Layer connections, specified as a table with two columns.

Each table row represents a connection in the layer graph. The first column, `Source`, specifies the source of each connection. The second column, `Destination`, specifies the destination of each connection. The connection sources and destinations are either layer names or have the form `'layerName/IOName'`, where `'IOName'` is the name of the layer input or output.

Data Types: table

**Learnales — Network learnable parameters**

table

Network learnable parameters, specified as a table with three columns:

- `Layer` - Layer name, specified as a string scalar.
- `Parameter` - Parameter name, specified as a string scalar.
- `Value` - Value of parameter, specified as a `dlarray`.

The network learnable parameters contain the features learned by the network. For example, the weights of convolution and fully connected layers.

Data Types: table

**State — Network state**

table

Network state, specified as a table.

The network state is a table with three columns:

- `Layer` - Layer name, specified as a string scalar.
- `Parameter` - Parameter name, specified as a string scalar.
- `Value` - Value of parameter, specified as a numeric array object.

The network state contains information remembered by the network between iterations. For example, the state of LSTM and batch normalization layers.

During training or inference, you can update the network state using the output of the `forward` and `predict` functions.

Data Types: table

**InputNames — Network input layer names**

cell array

Network input layer names, specified as a cell array of character vectors.

Data Types: cell

**OutputNames — Network output layer names**

cell array



Network output layer names, specified as a cell array of character vectors. This property includes all layers with disconnected outputs. If a layer has multiple outputs, then the disconnected outputs are specified as 'layerName/outputName'.

Data Types: cell

## Object Functions

forward      Compute deep learning network output for training  
 predict      Compute deep learning network output for inference  
 layerGraph   Graph of network layers for deep learning

## Examples

### Convert Pretrained Network to dlnetwork Object

To implement a custom training loop for your network, first convert it to a `dlnetwork` object. Do not include output layers in a `dlnetwork` object. Instead, you must specify the loss function in the custom training loop.

Load a pretrained GoogLeNet model using the `googlenet` function. This function requires the Deep Learning Toolbox™ *Model for GoogLeNet Network* support package. If this support package is not installed, then the function provides a download link.

```
net = googlenet;
```

Convert the network to a layer graph and remove the layers used for classification using `removeLayers`.

```
lgraph = layerGraph(net);  
lgraph = removeLayers(lgraph, ["prob" "output"]);
```

Convert the network to a `dlnetwork` object.

```
dlnet = dlnetwork(lgraph)
```

```
dlnet =  
  dlnetwork with properties:  
    Layers: [142x1 nnet.cnn.layer.Layer]  
 Connections: [168x2 table]  
 Learnables: [116x3 table]  
    State: [0x3 table]  
 InputNames: {'data'}  
 OutputNames: {'loss3-classifier'}
```

### Train Network Using Custom Training Loop

This example shows how to train a network that classifies handwritten digits with a custom learning rate schedule.

If `trainingOptions` does not provide the options you need (for example, a custom learning rate schedule), then you can define your own custom training loop using automatic differentiation.

This example trains a network to classify handwritten digits with the *time-based decay* learning rate schedule: for each iteration, the solver uses the learning rate given by  $\rho_t = \frac{\rho_0}{1+kt}$ , where  $t$  is the iteration number,  $\rho_0$  is the initial learning rate, and  $k$  is the decay.

### Load Training Data

Load the digits data.

```
[XTrain,YTrain] = digitTrain4DArrayData;
classes = categories(YTrain);
numClasses = numel(classes);
```

### Define Network

Define the network and specify the average image using the 'Mean' option in the image input layer.

```
layers = [
    imageInputLayer([28 28 1], 'Name', 'input', 'Mean', mean(XTrain,4))
    convolution2dLayer(5, 20, 'Name', 'conv1')
    batchNormalizationLayer('Name','bn1')
    reluLayer('Name', 'relu1')
    convolution2dLayer(3, 20, 'Padding', 1, 'Name', 'conv2')
    batchNormalizationLayer('Name','bn2')
    reluLayer('Name', 'relu2')
    convolution2dLayer(3, 20, 'Padding', 1, 'Name', 'conv3')
    batchNormalizationLayer('Name','bn3')
    reluLayer('Name', 'relu3')
    fullyConnectedLayer(numClasses, 'Name', 'fc')
    softmaxLayer('Name','softmax')];
lgraph = layerGraph(layers);
```

Create a `dlnetwork` object from the layer graph.

```
dlnet = dlnetwork(lgraph)
```

```
dlnet =
```

```
  dlnetwork with properties:
```

```
    Layers: [12x1 nnet.cnn.layer.Layer]
Connections: [11x2 table]
Learnables: [14x3 table]
    State: [6x3 table]
InputNames: {'input'}
OutputNames: {'softmax'}
```

### Define Model Gradients Function

Create the function `modelGradients`, listed at the end of the example, that takes a `dlnetwork` object `dlnet`, a mini-batch of input data `dlX` with corresponding labels `Y` and returns the gradients of the loss with respect to the learnable parameters in `dlnet` and the corresponding loss.

### Specify Training Options

Train with a minibatch size of 128 for 5 epochs.

```
numEpochs = 5;
miniBatchSize = 128;
```

Specify the options for SGDM optimization. Specify an initial learn rate of 0.01 with a decay of 0.01, and momentum 0.9.

```
initialLearnRate = 0.01;
decay = 0.01;
momentum = 0.9;
```

Visualize the training progress in a plot.

```
plots = "training-progress";
```

Train on a GPU if one is available. Using a GPU requires Parallel Computing Toolbox™ and a CUDA® enabled NVIDIA® GPU with compute capability 3.0 or higher.

```
executionEnvironment = "auto";
```

### Train Model

Train the model using a custom training loop.

For each epoch, shuffle the data and loop over mini-batches of data. At the end of each epoch, display the training progress.

For each mini-batch:

- Convert the labels to dummy variables.
- Convert the data to `dLarray` objects with underlying type `single` and specify the dimension labels 'SSCB' (spatial, spatial, channel, batch).
- For GPU training, convert to `gpuArray` objects.
- Evaluate the model gradients, state, and loss using `dLfeval` and the `modelGradients` function and update the network state.
- Determine the learning rate for the time-based decay learning rate schedule.
- Update the network parameters using the `sgdmupdate` function.

Initialize the training progress plot.

```
if plots == "training-progress"
    figure
    lineLossTrain = animatedline('Color',[0.85 0.325 0.098]);
    ylim([0 inf])
    xlabel("Iteration")
    ylabel("Loss")
    grid on
end
```

Initialize the velocity parameter for the SGDM solver.

```
velocity = [];
```

Train the network.

```
numObservations = numel(YTrain);
numIterationsPerEpoch = floor(numObservations./miniBatchSize);
```

```
iteration = 0;
start = tic;

% Loop over epochs.
for epoch = 1:numEpochs
    % Shuffle data.
    idx = randperm(numel(YTrain));
    XTrain = XTrain(:,:, :, idx);
    YTrain = YTrain(idx);

    % Loop over mini-batches.
    for i = 1:numIterationsPerEpoch
        iteration = iteration + 1;

        % Read mini-batch of data and convert the labels to dummy
        % variables.
        idx = (i-1)*miniBatchSize+1:i*miniBatchSize;
        X = XTrain(:,:, :, idx);

        Y = zeros(numClasses, miniBatchSize, 'single');
        for c = 1:numClasses
            Y(c,YTrain(idx)==classes(c)) = 1;
        end

        % Convert mini-batch of data to dlarray.
        dlX = dlarray(single(X), 'SSCB');

        % If training on a GPU, then convert data to gpuArray.
        if (executionEnvironment == "auto" && canUseGPU) || executionEnvironment == "gpu"
            dlX = gpuArray(dlX);
        end

        % Evaluate the model gradients, state, and loss using dlfeval and the
        % modelGradients function and update the network state.
        [gradients,state,loss] = dlfeval(@modelGradients,dlnet,dlX,Y);
        dlnet.State = state;

        % Determine learning rate for time-based decay learning rate schedule.
        learnRate = initialLearnRate/(1 + decay*iteration);

        % Update the network parameters using the SGDM optimizer.
        [dlnet, velocity] = sgdupdate(dlnet, gradients, velocity, learnRate, momentum);

        % Display the training progress.
        if plots == "training-progress"
            D = duration(0,0,toc(start), 'Format', 'hh:mm:ss');
            addpoints(lineLossTrain,iteration,double(gather(extractdata(loss))))
            title("Epoch: " + epoch + ", Elapsed: " + string(D))
            drawnow
        end
    end
end
```

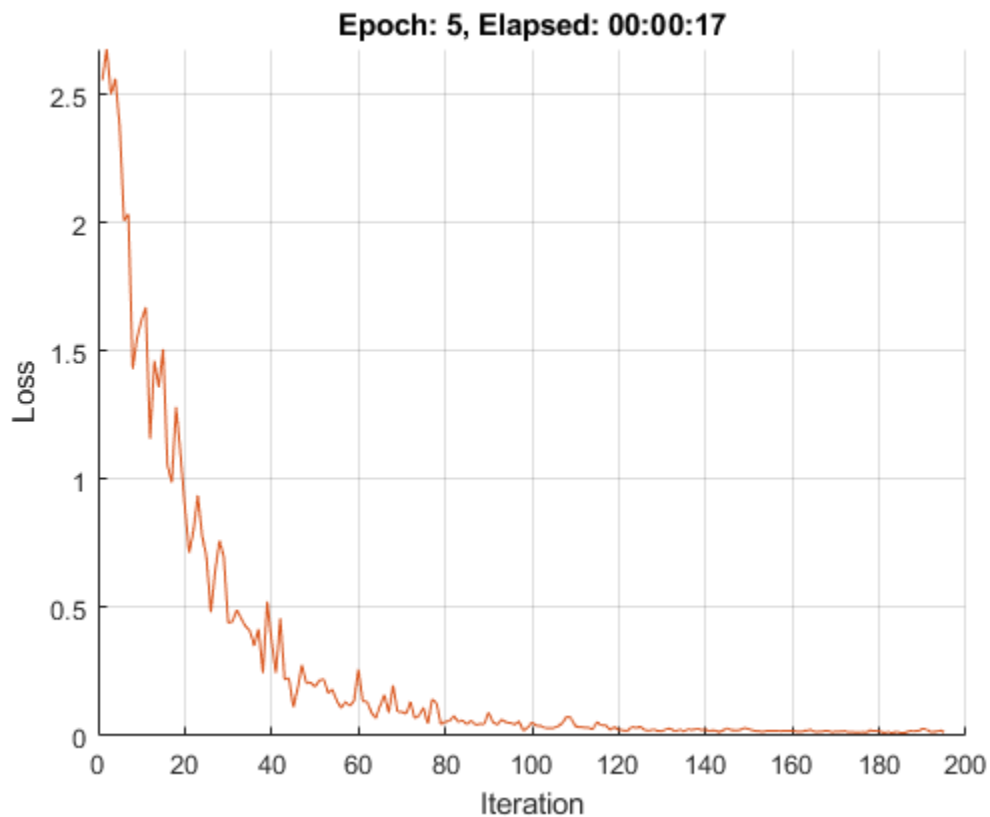

### Test Model

Test the classification accuracy of the model by comparing the predictions on a test set with the true labels.

```
[XTest, YTest] = digitTest4DArrayData;
```

Convert the data to a `darray` object with dimension format 'SSCB'. For GPU prediction, also convert the data to `gpuArray`.

```
dLXTest = darray(XTest, 'SSCB');
if (executionEnvironment == "auto" && canUseGPU) || executionEnvironment == "gpu"
    dLXTest = gpuArray(dLXTest);
end
```

Classify the images using `modelPredictions` function, listed at the end of the example and find the classes with the highest scores.

```
dLYPred = modelPredictions(dlnet, dLXTest, miniBatchSize);
[~, idx] = max(extractdata(dLYPred), [], 1);
YPred = classes(idx);
```

Evaluate the classification accuracy.

```
accuracy = mean(YPred == YTest)
```

```
accuracy = 0.9910
```

## Model Gradients Function

The `modelGradients` function takes a `dlnetwork` object `dlnet`, a mini-batch of input data `dlX` with corresponding labels `Y` and returns the gradients of the loss with respect to the learnable parameters in `dlnet`, the network state, and the loss. To compute the gradients automatically, use the `dlgradient` function.

```
function [gradients,state,loss] = modelGradients(dlnet,dlX,Y)

[dlYPred,state] = forward(dlnet,dlX);

loss = crossentropy(dlYPred,Y);
gradients = dlgradient(loss,dlnet.Learnables);

end
```

## Model Predictions Function

The `modelPredictions` function takes a `dlnetwork` object `dlnet`, an array of input data `dlX`, and a mini-batch size, and outputs the model predictions by iterating over mini-batches of the specified size.

```
function dlYPred = modelPredictions(dlnet,dlX,miniBatchSize)

numObservations = size(dlX,4);
numIterations = ceil(numObservations / miniBatchSize);

numClasses = dlnet.Layers(11).OutputSize;
dlYPred = zeros(numClasses,numObservations,'like',dlX);

for i = 1:numIterations
    idx = (i-1)*miniBatchSize+1:min(i*miniBatchSize,numObservations);

    dlYPred(:,idx) = predict(dlnet,dlX(:,:,,idx));
end



end
```

## More About

### Supported Layers







The `dlnetwork` function supports the layers listed below and custom layers without forward functions returning a nonempty memory value.

#### Input Layers



Layer	Description
 <code>imageInputLayer</code>	An image input layer inputs 2-D images to a network and applies data normalization.
 <code>image3dInputLayer</code>	A 3-D image input layer inputs 3-D images or volumes to a network and applies data normalization.

Layer	Description
 sequenceInputLayer	A sequence input layer inputs sequence data to a network.



### Convolution and Fully Connected Layers





Layer	Description
 convolution2dLayer	A 2-D convolutional layer applies sliding convolutional filters to the input.
 convolution3dLayer	A 3-D convolutional layer applies sliding cuboidal convolution filters to three-dimensional input.
 groupedConvolution2dLayer	A 2-D grouped convolutional layer separates the input channels into groups and applies sliding convolutional filters. Use grouped convolutional layers for channel-wise separable (also known as depth-wise separable) convolution.
 transposedConv2dLayer	A transposed 2-D convolution layer upsamples feature maps.
 transposedConv3dLayer	A transposed 3-D convolution layer upsamples three-dimensional feature maps.
 fullyConnectedLayer	A fully connected layer multiplies the input by a weight matrix and then adds a bias vector.

### Sequence Layers





Layer	Description
 sequenceInputLayer	A sequence input layer inputs sequence data to a network.
 lstmLayer	An LSTM layer learns long-term dependencies between time steps in time series and sequence data.
 gruLayer	A GRU layer learns dependencies between time steps in time series and sequence data.

### Activation Layers



Layer	Description
 reluLayer	A ReLU layer performs a threshold operation to each element of the input, where any value less than zero is set to zero.
 leakyReluLayer	A leaky ReLU layer performs a threshold operation, where any input value less than zero is multiplied by a fixed scalar.

Layer	Description
 clippedReluLayer	A clipped ReLU layer performs a threshold operation, where any input value less than zero is set to zero and any value above the <i>clipping ceiling</i> is set to that clipping ceiling.
 eluLayer	An ELU activation layer performs the identity operation on positive inputs and an exponential nonlinearity on negative inputs.
 tanhLayer	A hyperbolic tangent (tanh) activation layer applies the tanh function on the layer inputs.
 softmaxLayer	A softmax layer applies a softmax function to the input.







**Normalization, Dropout, and Cropping Layers**

Layer	Description
 batchNormalizationLayer	A batch normalization layer normalizes each input channel across a mini-batch. To speed up training of convolutional neural networks and reduce the sensitivity to network initialization, use batch normalization layers between convolutional layers and nonlinearities, such as ReLU layers.
 crossChannelNormalizationLayer	A channel-wise local response (cross-channel) normalization layer carries out channel-wise normalization.
 dropoutLayer	A dropout layer randomly sets input elements to zero with a given probability.
 crop2dLayer	A 2-D crop layer applies 2-D cropping to the input.



**Pooling and Unpooling Layers**

Layer	Description
 averagePooling2dLayer	An average pooling layer performs down-sampling by dividing the input into rectangular pooling regions and computing the average values of each region.
 averagePooling3dLayer	A 3-D average pooling layer performs down-sampling by dividing three-dimensional input into cuboidal pooling regions and computing the average values of each region.
 globalAveragePooling2dLayer	A global average pooling layer performs down-sampling by computing the mean of the height and width dimensions of the input.



Layer	Description
 globalAveragePooling3dLayer	A 3-D global average pooling layer performs down-sampling by computing the mean of the height, width, and depth dimensions of the input.
 maxPooling2dLayer	A max pooling layer performs down-sampling by dividing the input into rectangular pooling regions, and computing the maximum of each region.
 maxPooling3dLayer	A 3-D max pooling layer performs down-sampling by dividing three-dimensional input into cuboidal pooling regions, and computing the maximum of each region.
 globalMaxPooling2dLayer	A global max pooling layer performs down-sampling by computing the maximum of the height and width dimensions of the input.
 globalMaxPooling3dLayer	A 3-D global max pooling layer performs down-sampling by computing the maximum of the height, width, and depth dimensions of the input.
 maxUnpooling2dLayer	A max unpooling layer unpools the output of a max pooling layer.

### Combination Layers

Layer	Description
 additionLayer	An addition layer adds inputs from multiple neural network layers element-wise.
 depthConcatenationLayer	A depth concatenation layer takes inputs that have the same height and width and concatenates them along the third dimension (the channel dimension).
 concatenationLayer	A concatenation layer takes inputs and concatenates them along a specified dimension. The inputs must have the same size in all dimensions except the concatenation dimension.

### See Also

`dlarray` | `dlfeval` | `dlgradient` | `forward` | `layerGraph` | `predict`

### Topics

“Train Generative Adversarial Network (GAN)”

“Automatic Differentiation Background”

“Define Custom Training Loops, Loss Functions, and Networks”

### Introduced in R2019b

## predict

Compute deep learning network output for inference

### Syntax

```
dLY = predict(dlnet,dlX)
dLY = predict(dlnet,dlX1,...,dlXM)
[dLY1,...,dLYN] = predict( ___ )
[dLY1,...,dLYK] = predict( ___ , 'Outputs' , layerNames)
[ ___ ,state] = predict( ___ )
```

### Description

Some deep learning layers behave differently during training and inference (prediction). For example, during training, dropout layers randomly set input elements to zero to help prevent overfitting, but during inference, dropout layers do not change the input.

To compute network outputs for inference, use the `predict` function. To compute network outputs for training, use the `forward` function. For prediction with `SeriesNetwork` and `DAGNetwork` objects, see `predict`.

`dLY = predict(dlnet,dlX)` returns the network output `dLY` during inference given the input data `dlX` and the network `dlnet` with a single input and a single output.

`dLY = predict(dlnet,dlX1,...,dlXM)` returns the network output `dLY` during inference given the `M` inputs `dlX1, ..., dlXM` and the network `dlnet` that has `M` inputs and a single output.

`[dLY1,...,dLYN] = predict( ___ )` returns the `N` outputs `dLY1, ..., dLYN` during inference for networks that have `N` outputs using any of the previous syntaxes.

`[dLY1,...,dLYK] = predict( ___ , 'Outputs' , layerNames)` returns the outputs `dLY1, ..., dLYK` during inference for the specified layers using any of the previous syntaxes.

`[ ___ ,state] = predict( ___ )` also returns the updated network state using any of the previous syntaxes.

---

**Tip** For prediction with `SeriesNetwork` and `DAGNetwork` objects, see `predict`.

---

## Examples

### Make Predictions Using dlnetwork Object

This example shows how to make predictions using a `dlnetwork` object by splitting data into mini-batches.

For large data sets, or when predicting on hardware with limited memory, make predictions by splitting the data into mini-batches. When making predictions with `SeriesNetwork` or `DAGNetwork`

objects, the `predict` function automatically splits the input data into mini-batches. For `dlnetwork` objects, you must split the data into mini-batches manually.

### Load `dlnetwork` Object

Load a trained `dlnetwork` object and the corresponding classes.

```
s = load("digitsCustom.mat");
dlnet = s.dlnet;
classes = s.classes;
```

### Load Data for Prediction

Load the digits data for prediction.

```
digitDatasetPath = fullfile(matlabroot,'toolbox','nnet','nndemos', ...
    'nndatasets','DigitDataset');
imds = imageDatastore(digitDatasetPath, ...
    'IncludeSubfolders',true);
```

### Make Predictions

Loop over the mini-batches of the test data and make predictions using a custom prediction loop. To read a mini-batch of data from the datastore, set the `ReadSize` property to the mini-batch size.

For each mini-batch:

- Convert the data to `dlarray` objects with underlying type `single` and specify the dimension labels 'SSCB' (spatial, spatial, channel, batch).
- For GPU prediction, convert to `gpuArray` objects.
- Make predictions using the `predict` function.
- Determine the class labels by finding the maximum scores.

Specify the prediction options. Specify a mini-batch size of 128 and make predictions on a GPU if one is available. Using a GPU requires Parallel Computing Toolbox™ and a CUDA® enabled NVIDIA® GPU with compute capability 3.0 or higher.

```
miniBatchSize = 128;
executionEnvironment = "auto";
```

Set the read size property of the image datastore to the mini-batch size.

```
imds.ReadSize = miniBatchSize;
```

Make predictions by looping over the mini-batches of data.

```
numObservations = numel(imds.Files);
YPred = strings(1,numObservations);
i = 1;
```

```
% Loop over mini-batches.
while hasdata(imds)
```

```
    % Read mini-batch of data.
    data = read(imds);
    X = cat(4,data{:});
```

```
% Normalize the images.
X = single(X)/255;

% Convert mini-batch of data to darray.
dLX = darray(X, 'SSCB');

% If training on a GPU, then convert data to gpuArray.
if (executionEnvironment == "auto" && canUseGPU) || executionEnvironment == "gpu"
    dLX = gpuArray(dLX);
end

% Make predictions using the predict function.
dLYPred = predict(dlnet,dLX);

% Determine corresponding classes.
[~,idxTop] = max(extractdata(dLYPred),[],1);
idxMiniBatch = i:min((i+miniBatchSize-1),numObservations);
YPred(idxMiniBatch) = classes(idxTop);

i = i + miniBatchSize;
end
```

Visualize some of the predictions.

```
idx = randperm(numObservations,9);
figure
for i = 1:9
    subplot(3,3,i)
    I = imread(imds.Files{idx(i)});
    label = YPred(idx(i));
    imshow(I)
    title("Label: " + label)
end
```

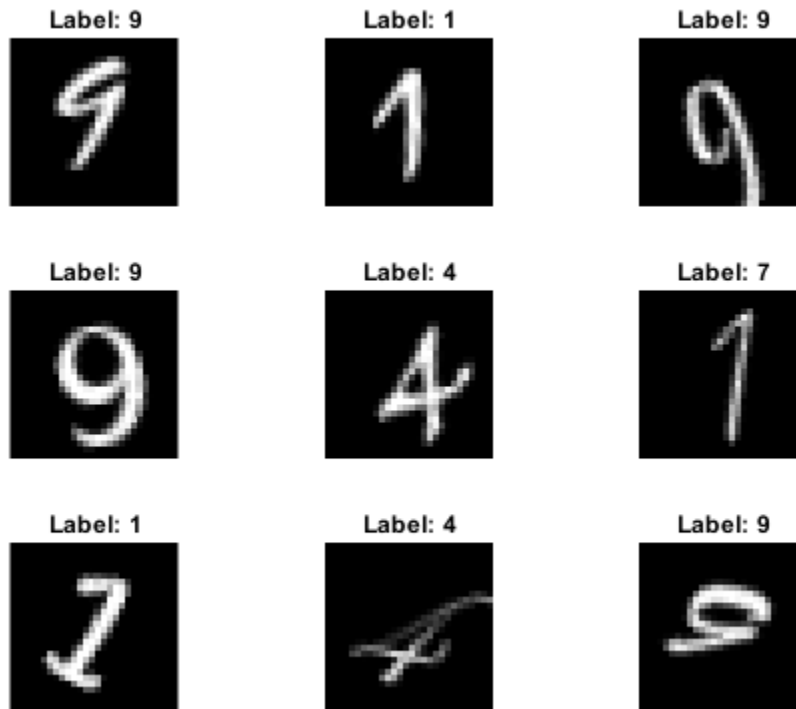

## Input Arguments

### **dlnet** — Network for custom training loops

`dlnetwork` object

Network for custom training loops, specified as a `dlnetwork` object.

### **dIX** — Input data

formatted `dIarray`

Input data, specified as a formatted `dIarray`. For more information about `dIarray` formats, see the `fmt` input argument of `dIarray`.

### **layerNames** — Layers to extract outputs from

string array | cell array of character vectors

Layers to extract outputs from, specified as a string array or a cell array of character vectors containing the layer names.

- If `layerNames(i)` corresponds to a layer with a single output, then `layerNames(i)` is the name of the layer.
- If `layerNames(i)` corresponds to a layer with multiple outputs, then `layerNames(i)` is the layer name followed by the character "/" and the name of the layer output: 'layerName/outputName'.

## Output Arguments

### **dLY** — Output data

formatted `dLarray`

Output data, returned as a formatted `dLarray`. For more information about `dLarray` formats, see the `fmt` input argument of `dLarray`.

### **state** — Updated network state

table

Updated network state, returned as a table.

The network state is a table with three columns:

- `Layer` - Layer name, specified as a string scalar.
- `Parameter` - Parameter name, specified as a string scalar.
- `Value` - Value of parameter, specified as a numeric array object.

The network state contains information remembered by the network between iterations. For example, the state of LSTM and batch normalization layers.

Update the state of a `dlnetwork` using the `State` property.

## Extended Capabilities

### **GPU Arrays**

Accelerate code by running on a graphics processing unit (GPU) using Parallel Computing Toolbox™.

Usage notes and limitations:

- This function runs on the GPU if either or both of the following conditions are met:
  - Any of the values of the network learnable parameters inside `dlnet.Learnables.Value` are `dLarray` objects with underlying data of type `gpuArray`
  - The input argument `dLX` is a `dLarray` with underlying data of type `gpuArray`

For more information, see “Run MATLAB Functions on a GPU” (Parallel Computing Toolbox).

### **See Also**

`dLarray` | `dlfeval` | `dlgradient` | `dlnetwork` | `forward`

### **Topics**

“Train Generative Adversarial Network (GAN)”

“Automatic Differentiation Background”

“Define Custom Training Loops, Loss Functions, and Networks”

### **Introduced in R2019b**

# dupdate

Update parameters using custom function

## Syntax

```
dlnet = dupdate(fun,dlnet)
params = dupdate(fun,params)
[ ___ ] = dupdate(fun, ___ A1,...,An)
[ ___ ,X1,...,Xm] = dupdate(fun, ___ )
```

## Description

`dlnet = dupdate(fun,dlnet)` updates the learnable parameters of the `dlnetwork` object `dlnet` by evaluating the function `fun` with each learnable parameter as an input. `fun` is a function handle to a function that takes one parameter array as an input argument and returns an updated parameter array.

`params = dupdate(fun,params)` updates the learnable parameters in `params` by evaluating the function `fun` with each learnable parameter as an input.

`[ ___ ] = dupdate(fun, ___ A1,...,An)` also specifies additional input arguments, in addition to the input arguments in previous syntaxes, when `fun` is a function handle to a function that requires `n+1` input values.

`[ ___ ,X1,...,Xm] = dupdate(fun, ___ )` returns multiple outputs `X1,...,Xm` when `fun` is a function handle to a function that returns `m+1` output values.

## Examples

### L1 Regularization with dupdate

Perform L1 regularization on a structure of parameter gradients.

Create the sample input data.

```
d1X = darray(rand(100,100,3), 'SSC');
```

Initialize the learnable parameters for the convolution operation.

```
params.Weights = darray(rand(10,10,3,50));
params.Bias = darray(rand(50,1));
```

Calculate the gradients for the convolution operation using the helper function `convGradients`, defined at the end of this example.

```
grads = dlfeval(@convGradients,d1X,params);
```

Define the regularization factor.

```
L1Factor = 0.001;
```

Create an anonymous function that regularizes the gradients. By using an anonymous function to pass a scalar constant to the function, you can avoid having to expand the constant value to the same size and structure as the parameter variable.

```
L1Regularizer = @(grad,param) grad + L1Factor.*sign(param);
```

Use `dlupdate` to apply the regularization function to each of the gradients.

```
grads = dlupdate(L1Regularizer,grads,params);
```

The gradients in `grads` are now regularized according to the function `L1Regularizer`.

### **convGradients Function**

The `convGradients` helper function takes the learnable parameters of the convolution operation and a mini-batch of input data `dIX`, and returns the gradients with respect to the learnable parameters.

```
function grads = convGradients(dIX,params)
dLY = dlconv(dIX,params.Weights,params.Bias);
dLY = sum(dLY,'all');
grads = dlgradient(dLY,params);
end
```

### **Use dlupdate to Train Network Using Custom Update Function**

Use `dlupdate` to train a network using a custom update function that implements the stochastic gradient descent algorithm (without momentum).

#### **Load Training Data**

Load the digits training data.

```
[XTrain,YTrain] = digitTrain4DArrayData;
classes = categories(YTrain);
numClasses = numel(classes);
```

#### **Define the Network**

Define the network architecture and specify the average image value using the 'Mean' option in the image input layer.

```
layers = [
    imageInputLayer([28 28 1], 'Name','input','Mean',mean(XTrain,4))
    convolution2dLayer(5,20,'Name','conv1')
    reluLayer('Name','relu1')
    convolution2dLayer(3,20,'Padding',1,'Name','conv2')
    reluLayer('Name','relu2')
    convolution2dLayer(3,20,'Padding',1,'Name','conv3')
    reluLayer('Name','relu3')
    fullyConnectedLayer(numClasses,'Name','fc')];
lgraph = layerGraph(layers);
```

Create a `dlnetwork` object from the layer graph.

```
dlnet = dlnetwork(lgraph);
```



### Define Model Gradients Function

Create the helper function `modelGradients`, listed at the end of this example. The function takes a `dlnetwork` object `dlnet` and a mini-batch of input data `dX` with corresponding labels `Y`, and returns the loss and the gradients of the loss with respect to the learnable parameters in `dlnet`.

### Define Stochastic Gradient Descent Function

Create the helper function `sgdFunction`, listed at the end of this example. The function takes `param` and `paramGradient`, a learnable parameter and the gradient of the loss with respect to that parameter, respectively, and returns the updated parameter using the stochastic gradient descent algorithm, expressed as

$$\theta_{l+1} = \theta - \alpha \nabla E(\theta_l)$$

where  $l$  is the iteration number,  $\alpha > 0$  is the learning rate,  $\theta$  is the parameter vector, and  $E(\theta)$  is the loss function.

### Specify Training Options

Specify the options to use during training.

```
miniBatchSize = 128;
numEpochs = 20;
numObservations = numel(YTrain);
numIterationsPerEpoch = floor(numObservations./miniBatchSize);
```

Train on a GPU, if one is available. Using a GPU requires Parallel Computing Toolbox™ and a CUDA® enabled NVIDIA® GPU with compute capability 3.0 or higher.

```
executionEnvironment = "auto";
```

Initialize the velocity parameter.

```
learnRate = 0.001;
```

Initialize the training progress plot.

```
plots = "training-progress";
if plots == "training-progress"
    iteration = 1;
    figure
    lineLossTrain = animatedline;
    xlabel("Total Iterations")
    ylabel("Loss")
end
```

### Train Network

Train the model using a custom training loop. For each epoch, shuffle the data and loop over mini-batches of data. Update the network parameters by calling `dlupdate` with the function `sgdFunction` defined at the end of this example. At the end of each epoch, display the training progress.

```
for epoch = 1:numEpochs
    % Shuffle data.
    idx = randperm(numel(YTrain));
```

```
XTrain = XTrain(:,:,:,idx);
YTrain = YTrain(idx);

for i = 1:numIterationsPerEpoch

    % Read mini-batch of data and convert the labels to dummy
    % variables.
    idx = (i-1)*miniBatchSize+1:i*miniBatchSize;
    X = XTrain(:,:,:,idx);

    Y = zeros(numClasses, miniBatchSize, 'single');
    for c = 1:numClasses
        Y(c,YTrain(idx)==classes(c)) = 1;
    end

    % Convert mini-batch of data to dlarray.
    dlX = dlarray(single(X), 'SSCB');

    % If training on a GPU, then convert data to a gpuArray.
    if (executionEnvironment == "auto" && canUseGPU) || executionEnvironment == "gpu"
        dlX = gpuArray(dlX);
    end

    % Evaluate the model gradients and loss using dlfeval and the
    % modelGradients helper function.
    [grad,loss] = dlfeval(@modelGradients,dlnet,dlX,Y);

    % Update the network parameters using the SGD algorithm defined in the
    % sgdfFunction helper function.
    dlnet = dlupdate(@sgdfFunction,dlnet,grad);

    % Display the training progress.
    if plots == "training-progress"
        addpoints(lineLossTrain,iteration,double(gather(extractdata(loss))))
        title("Loss During Training: Epoch - " + epoch + "; Iteration - " + i)
        drawnow
        iteration = iteration + 1;
    end
end
end
```

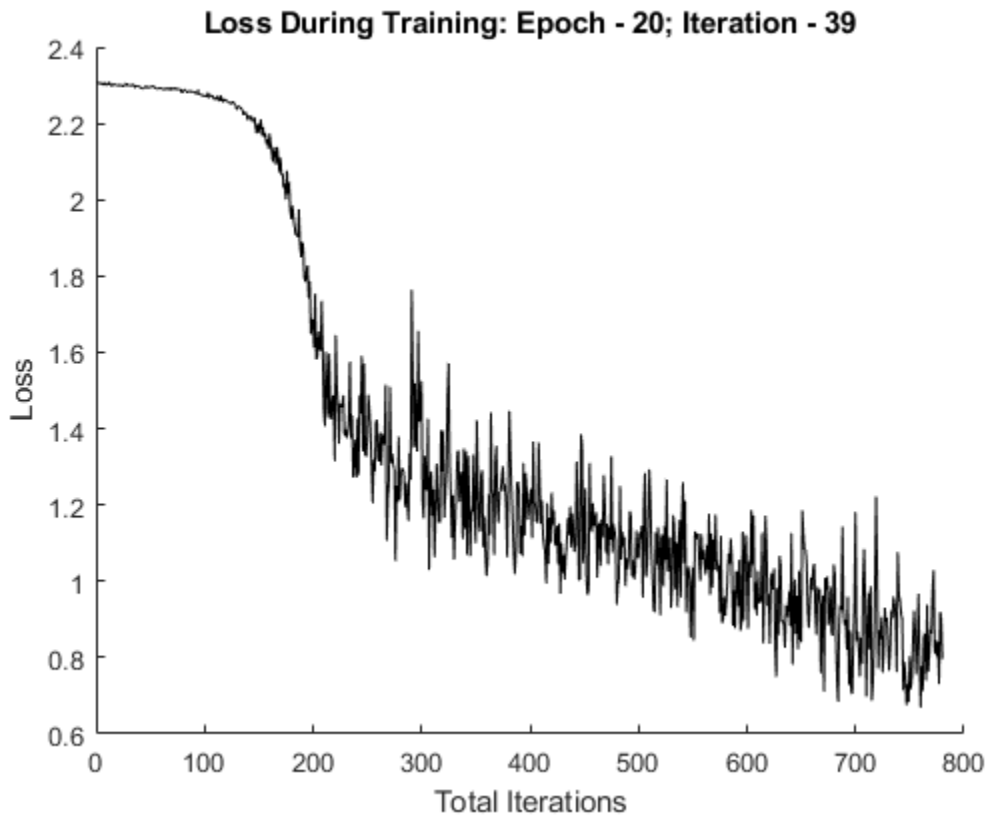

### Test Network

Test the classification accuracy of the model by comparing the predictions on a test set with the true labels.

```
[XTest, YTest] = digitTest4DArrayData;
```

Convert the data to a `dlarray` with the dimension format 'SSCB'. For GPU prediction, also convert the data to a `gpuArray`.

```
dlXTest = dlarray(XTest, 'SSCB');
if (executionEnvironment == "auto" && canUseGPU) || executionEnvironment == "gpu"
    dlXTest = gpuArray(dlXTest);
end
```

To classify images using a `dlnetwork` object, use the `predict` function and find the classes with the highest scores.

```
dlYPred = predict(dlnet, dlXTest);
[~, idx] = max(extractdata(dlYPred), [], 1);
YPred = classes(idx);
```

Evaluate the classification accuracy.

```
accuracy = mean(YPred==YTest)
```

```
accuracy = 0.7282
```

## Model Gradients Function

The helper function `modelGradients` takes a `dlnetwork` object `dlnet` and a mini-batch of input data `dlX` with corresponding labels `Y`, and returns the loss and the gradients of the loss with respect to the learnable parameters in `dlnet`. To compute the gradients automatically, use the `dlgradient` function.

```
function [gradients,loss] = modelGradients(dlnet,dlX,Y)
    dLYPred = forward(dlnet,dlX);
    dLYPred = softmax(dLYPred);

    loss = crossentropy(dLYPred,Y);
    gradients = dlgradient(loss,dlnet.Learnables);
end
```

## Stochastic Gradient Descent Function

The helper function `sgdFunction` takes `param` and `paramGradient`, a learnable parameter and the gradient of the loss with respect to that parameter respectively, and returns the updated parameter using the stochastic gradient descent algorithm, expressed as

$$\theta_{l+1} = \theta - \alpha \nabla E(\theta_l)$$

where  $l$  is the iteration number,  $\alpha > 0$  is the learning rate,  $\theta$  is the parameter vector, and  $E(\theta)$  is the loss function.

```
function param = sgdFunction(param,paramGradient)
    learnRate = 0.01;
    param = param - learnRate.*paramGradient;
end
```

## Input Arguments

### **fun** — Function to apply

function handle

Function to apply to the learnable parameters, specified as a function handle.

`dlupdate` evaluates `fun` with each network learnable parameter as an input. `fun` is evaluated as many times as there are arrays of learnable parameters in `dlnet` or `params`.

### **dlnet** — Network

`dlnetwork` object

Network, specified as a `dlnetwork` object.

The function updates the `dlnet.Learnables` property of the `dlnetwork` object. `dlnet.Learnables` is a table with three variables:

- **Layer** — Layer name, specified as a string scalar.
- **Parameter** — Parameter name, specified as a string scalar.
- **Value** — Value of parameter, specified as a cell array containing a `dlarray`.

**params — Network learnable parameters**

`d\array` | numeric array | cell array | structure | table

Network learnable parameters, specified as a `d\array`, a numeric array, a cell array, a structure, or a table.

If you specify `params` as a table, it must contain the following three variables.

- `Layer` — Layer name, specified as a string scalar.
- `Parameter` — Parameter name, specified as a string scalar.
- `Value` — Value of parameter, specified as a cell array containing a `d\array`.

You can specify `params` as a container of learnable parameters for your network using a cell array, structure, or table, or nested cell arrays or structures. The learnable parameters inside the cell array, structure, or table must be `d\array` or numeric values of data type `double` or `single`.

The input argument `grad` must be provided with exactly the same data type, ordering, and fields (for structures) or variables (for tables) as `params`.

Data Types: `single` | `double` | `struct` | `table` | `cell`

**A1, . . . ,An — Additional input arguments**

`d\array` | numeric array | cell array | structure | table

Additional input arguments to `fun`, specified as `d\array` objects, numeric arrays, cell arrays, structures, or tables with a `Value` variable.

The exact form of `A1, . . . ,An` depends on the input network or learnable parameters. The following table shows the required format for `A1, . . . ,An` for possible inputs to `d\update`.

Input	Learnable Parameters	A1, . . . ,An
<code>d\net</code>	Table <code>d\net.Learnables</code> containing <code>Layer</code> , <code>Parameter</code> , and <code>Value</code> variables. The <code>Value</code> variable consists of cell arrays that contain each learnable parameter as a <code>d\array</code> .	Table with the same data type, variables, and ordering as <code>d\net.Learnables</code> . <code>A1, . . . ,An</code> must have a <code>Value</code> variable consisting of cell arrays that contain the additional input arguments for the function <code>fun</code> to apply to each learnable parameter.
<code>params</code>	<code>d\array</code>	<code>d\array</code> with the same data type and ordering as <code>params</code>
	Numeric array	Numeric array with the same data type and ordering as <code>params</code>
	Cell array	Cell array with the same data types, structure, and ordering as <code>params</code>
	Structure	Structure with the same data types, fields, and ordering as <code>params</code>

Input	Learnable Parameters	A1, . . . , An
	Table with Layer, Parameter, and Value variables. The Value variable must consist of cell arrays that contain each learnable parameter as a darray.	Table with the same data types, variables and ordering as params. A1, . . . , An must have a Value variable consisting of cell arrays that contain the additional input argument for the function fun to apply to each learnable parameter.

## Output Arguments

### dlnet — Updated network

dlnetwork object

Network, returned as a dlnetwork object.

The function updates the dlnet.Learnables property of the dlnetwork object.

### params — Updated network learnable parameters

darray | numeric array | cell array | structure | table

Updated network learnable parameters, returned as a darray, a numeric array, a cell array, a structure, or a table with a Value variable containing the updated learnable parameters of the network.

### X1, . . . , Xm — Additional output arguments

darray | numeric array | cell array | structure | table

Additional output arguments from the function fun, where fun is a function handle to a function that returns multiple outputs, returned as darray objects, numeric arrays, cell arrays, structures, or tables with a Value variable.

The exact form of X1, . . . , Xm depends on the input network or learnable parameters. The following table shows the returned format of X1, . . . , Xm for possible inputs to dupdate.

Input	Learnable parameters	X1, . . . , Xm
dlnet	Table dlnet.Learnables containing Layer, Parameter, and Value variables. The Value variable consists of cell arrays that contain each learnable parameter as a darray.	Table with the same data type, variables, and ordering as dlnet.Learnables. X1, . . . , Xm has a Value variable consisting of cell arrays that contain the additional output arguments of the function fun applied to each learnable parameter.
params	darray	darray with the same data type and ordering as params

Input	Learnable parameters	$X_1, \dots, X_m$
	Numeric array	Numeric array with the same data type and ordering as <code>params</code>
	Cell array	Cell array with the same data types, structure, and ordering as <code>params</code>
	Structure	Structure with the same data types, fields, and ordering as <code>params</code>
	Table with <code>Layer</code> , <code>Parameter</code> , and <code>Value</code> variables. The <code>Value</code> variable must consist of cell arrays that contain each learnable parameter as a <code>dlarray</code> .	Table with the same data types, variables, and ordering as <code>params</code> . $X_1, \dots, X_m$ has a <code>Value</code> variable consisting of cell arrays that contain the additional output argument of the function <code>fun</code> applied to each learnable parameter.

## Extended Capabilities

### GPU Arrays

Accelerate code by running on a graphics processing unit (GPU) using Parallel Computing Toolbox™.

Usage notes and limitations:

- When at least one of the following input arguments is a `gpuArray` or a `dlarray` with underlying data of type `gpuArray`, this function runs on the GPU.
  - `params`
  - $A_1, \dots, A_n$

For more information, see “Run MATLAB Functions on a GPU” (Parallel Computing Toolbox).

### See Also

`adamupdate` | `dlarray` | `dlfeval` | `dlgradient` | `dlnetwork` | `rmspropupdate` | `sgdmupdate`

### Topics

“Define Custom Training Loops, Loss Functions, and Networks”

“Specify Training Options in Custom Training Loop”

“Train Network Using Custom Training Loop”

“Sequence-to-Sequence Translation Using Attention”

“Sequence-to-Sequence Classification Using 1-D Convolutions”

### Introduced in R2019b

## dltranspconv

Deep learning transposed convolution

### Syntax

```
dLY = dltranspconv(dlX,weights,bias)
dLY = dltranspconv(dlX,weights,bias,'DataFormat',FMT)
dLY = dltranspconv( ___ Name,Value)
```

### Description

The transposed convolution operation upsamples feature maps.

---

**Note** This function applies the deep learning transposed convolution operation to `darray` data. If you want to apply transposed convolution within a `layerGraph` object or `Layer` array, use one of the following layers:

- `transposedConv2dLayer`
  - `transposedConv3dLayer`
- 

`dLY = dltranspconv(dlX,weights,bias)` computes the deep learning transposed convolution of the input `dlX` using the filters defined by `weights`, and adds a constant `bias`. The input `dlX` is a formatted `darray` with dimension labels. Transposed convolution acts on dimensions that you specify as 'S' and 'C' dimensions. The output `dLY` is a formatted `darray` with the same dimension labels as `dlX`.

`dLY = dltranspconv(dlX,weights,bias,'DataFormat',FMT)` also specifies the dimension format `FMT` when `dlX` is not a formatted `darray`. The output `dLY` is an unformatted `darray` with the same dimension order as `dlX`.

`dLY = dltranspconv( ___ Name,Value)` specifies options using one or more name-value pair arguments in addition to the input arguments in previous syntaxes. For example, 'Stride',3 sets the stride of the convolution operation.

### Examples

#### Upsample Image Using Transposed Convolution

Convolve an image and then use transposed convolution to resize the convolved image to the same size as the original image.

Import the image data and convert it to a `darray`.

```
X = imread('sherlock.jpg');
dlX = darray(single(X),'SSC');
```

Display the image.



```
imshow(X)
```



Initialize the convolutional filters and bias term. Specify an ungrouped convolution that applies a single filter to all three channels of the input data.

```
filterHeight = 10;  
filterWidth = 10;  
numChannelsPerGroup = 3;  
numFiltersPerGroup = 1;  
numGroups = 1;
```

```
weights = rand(filterHeight,filterWidth,numChannelsPerGroup,numFiltersPerGroup,numGroups);  
bias = rand(numFiltersPerGroup*numGroups,1);
```

Perform the convolution. Use a 'Stride' value of 2 and a 'DilationFactor' value of 2.

```
dLY = dlconv(dLX,weights,bias,'Stride',2,'DilationFactor',3);
```

Display the convolved image.

```
Y = extractdata(dLY);  
imshow(rescale(Y))
```



Initialize the transposed convolutional filters and bias. Specify an ungrouped transposed convolution that applies three filters to the input. Use the same filter height and filter width as for the convolution operation.

```
numChannelsPerGroupTC = 1;  
numFiltersPerGroupTC = 3;
```

```
weightsTC = rand(filterHeight,filterWidth,numFiltersPerGroupTC,numChannelsPerGroupTC,numGroups);  
biasTC = rand(numFiltersPerGroupTC*numGroups,1);
```

Perform the transposed convolution. Use the same stride and dilation factor as for the convolution operation.

```
dLZ = dltranspconv(dLY,weightsTC,biasTC,'Stride',2,'DilationFactor',3);
```

Display the image after the transposed convolution.

```
Z = extractdata(dLZ);  
imshow(rescale(Z))
```



Compare the size of the original image, the convolved image, and the image after the transposed convolution.

```
sizeX = size(X)
```

```
sizeX = 1×3
```

```
    640    960     3
```

```
sizeY = size(Y)
```

```
sizeY = 1×2
```

```
    307    467
```

```
sizeZ = size(Z)
```

```
sizeZ = 1×3
```

```
    640    960     3
```

The transposed convolution upsamples the convolved data to the size of the original input data.

## Perform Grouped Transposed Convolution

Apply transposed convolution to the input data in three groups of two channels each. Apply four filters per group.

Create the input data as ten observations of size 100-by-100 with six channels.

```
height = 100;  
width = 100;  
channels = 6;  
numObservations = 10;  
  
X = rand(height,width,channels,numObservations);  
dLX = dlarray(X, 'SSCB');
```

Initialize the filters for the transposed convolution operation. Specify three groups of transposed convolutions that each apply four filters to two channels of the input data.

```
filterHeight = 8;  
filterWidth = 8;  
numChannelsPerGroup = 2;  
numFiltersPerGroup = 4;  
numGroups = 3;  
  
weights = rand(filterHeight,filterWidth,numFiltersPerGroup,numChannelsPerGroup,numGroups);
```

Initialize the bias term.

```
bias = rand(numFiltersPerGroup*numGroups,1);
```

Perform the transposed convolution.

```
dLY = dltranspconv(dLX,weights,bias);  
size(dLY)
```

```
ans = 1×4
```

```
    107    107     12     10
```

```
dims(dLY)
```

```
ans =  
'SSCB'
```

The 12 channels of the convolution output represent the three groups of transposed convolutions with four filters per group.

## Input Arguments

### **dLX** — Input data

dlarray | numeric array

Input data, specified as a `darray` with or without dimension labels or a numeric array. When `dX` is not a formatted `darray`, you must specify the dimension label format using `'DataFormat', FMT`. If `dX` is a numeric array, at least one of `weights` or `bias` must be a `darray`.

Convolution acts on dimensions that you specify as spatial dimensions using the `'S'` dimension label. You can specify up to three dimensions in `dX` as `'S'` dimensions.

Data Types: `single` | `double`

### **weights — Filters**

`darray` | numeric array

Filters, specified as a `darray` with or without labels or a numeric array. The `weights` argument specifies the size and values of the filters, as well as the number of filters and the number of groups for grouped transposed convolutions.

Specify weights as a `filterSize-by-numFiltersPerGroup-by-numChannelsPerGroup-by-numGroups` array.

- `filterSize` — Size of the convolutional filters. `filterSize` can have up to three dimensions, depending on the number of spatial dimensions in the input data.

Input Data 'S' Dimensions	filterSize
1-D	$h$ , where $h$ corresponds to the height of the filter
2-D	$h$ -by- $w$ , where $h$ and $w$ correspond to the height and width of the filter, respectively
3-D	$h$ -by- $w$ -by- $d$ , where $h$ , $w$ , and $d$ correspond to the height, width, and depth of the filter, respectively

- `numFiltersPerGroup` — Number of filters to apply within each group.
- `numChannelsPerGroup` — Number of channels within each group for grouped transposed convolutions. `numChannelsPerGroup` must equal the number of channels in the input data divided by `numGroups`, the number of groups. For ungrouped convolutions, where `numGroups = 1`, `numChannelsPerGroup` must equal the number of channels in the input data.
- `numGroups` — Number of groups (optional). When `numGroups > 1`, the function performs grouped transposed convolutions. When `numGroups = 1`, the function performs ungrouped transposed convolutions; in this case, this dimension is singleton and can be omitted.

If `weights` is a formatted `darray`, it can have multiple spatial dimensions labeled `'S'`, one channel dimension labeled `'C'`, and up to two other dimensions labeled `'U'`. The number of `'S'` dimensions must match the number of `'S'` dimensions of the input data. The labeled dimensions correspond to the filter specifications as follows.

Filter Specification	Dimension Labels
<code>filterSize</code>	Up to three <code>'S'</code> dimensions
<code>numFiltersPerGroup</code>	<code>'C'</code> dimension
<code>numChannelsPerGroup</code>	First <code>'U'</code> dimension
<code>numGroups</code> (optional)	Second <code>'U'</code> dimension

Data Types: `single` | `double`

**bias — Bias constant**`dlarray vector | dlarray scalar | numeric vector | numeric scalar`

Bias constant, specified as a `dlarray` vector or `dlarray` scalar with or without labels, a numeric vector, or a numeric scalar.

- If `bias` is a scalar or has only singleton dimensions, the same bias is applied to each entry of the output.
- If `bias` has a nonsingleton dimension, each element of `bias` is the bias applied to the corresponding convolutional filter specified by `weights`. The number of elements of `bias` must match the number of filters specified by `weights`.

If `bias` is a formatted `dlarray`, the nonsingleton dimension must be a channel dimension labeled 'C'.

Data Types: `single` | `double`

**Name-Value Pair Arguments**

Specify optional comma-separated pairs of `Name`, `Value` arguments. `Name` is the argument name and `Value` is the corresponding value. `Name` must appear inside quotes. You can specify several name and value pair arguments in any order as `Name1, Value1, ..., NameN, ValueN`.

Example: `'Stride', 2` sets the stride of each filter to 2.

**DataFormat — Dimension order of unformatted data**`char array | string`

Dimension order of unformatted input data, specified as the comma-separated pair consisting of `'DataFormat'` and a character array or string `FMT` that provides a label for each dimension of the data. Each character in `FMT` must be one of the following:

- 'S' — Spatial
- 'C' — Channel
- 'B' — Batch (for example, samples and observations)
- 'T' — Time (for example, sequences)
- 'U' — Unspecified

You can specify multiple dimensions labeled 'S' or 'U'. You can use the labels 'C', 'B', and 'T' at most once.

You must specify `'DataFormat'` when the input data `dLX` is not a formatted `dlarray`.

Example: `'DataFormat', 'SSCB'`

Data Types: `char` | `string`

**Stride — Step size for traversing input data**`1 (default) | numeric scalar | numeric vector`

Step size for traversing the input data, specified as the comma-separated pair consisting of `'Stride'` and a numeric scalar or numeric vector. If you specify `'Stride'` as a scalar, the same value is used for all spatial dimensions. If you specify `'Stride'` as a vector of the same size as the number of spatial dimensions of the input data, the vector values are used for the corresponding spatial dimensions.

The default value of 'Stride' is 1.

Example: 'Stride',3

Data Types: single | double

### **DilationFactor — Filter dilation factor**

1 (default) | numeric scalar | numeric vector

Filter dilation factor, specified as the comma-separated pair consisting of 'DilationFactor' and one of the following.

- Numeric scalar — The same dilation factor value is applied for all spatial dimensions.
- Numeric vector — A different dilation factor value is applied along each spatial dimension. Use a vector of size  $d$ , where  $d$  is the number of spatial dimensions of the input data. The  $i$ th element of the vector specifies the dilation factor applied to the  $i$ th spatial dimension.

Use the dilation factor to increase the receptive field of the filter (the area of the input that the filter can see) on the input data. Using a dilation factor corresponds to an effective filter size of  $\text{filterSize} + (\text{filterSize}-1)*(\text{dilationFactor}-1)$ .

Example: 'DilationFactor',2

Data Types: single | double

### **Cropping — Cropping applied to edges of data**

0 (default) | 'same' | numeric scalar | numeric vector | numeric matrix

Cropping applied to edges of data, specified as the comma-separated pair consisting of 'Cropping' and one of the following.

- 'same' — Cropping is set so that the output size is the same as the input size when the stride is 1. More generally, the output size of each spatial dimension is  $\text{inputSize}*\text{stride}$ , where  $\text{inputSize}$  is the size of the input along a spatial dimension.
- Numeric scalar — The same cropping value is applied to both ends of all spatial dimensions.
- Numeric vector — A different cropping value is applied along each spatial dimension. Use a vector of size  $d$ , where  $d$  is the number of spatial dimensions of the input data. The  $i$ th element of the vector specifies the cropping applied to the start and the end along the  $i$ th spatial dimension.
- Numeric matrix — A different cropping value is applied to the start and end of each spatial dimension. Use a matrix of size 2-by- $d$ , where  $d$  is the number of spatial dimensions of the input data. The element  $(1, d)$  specifies the cropping applied to the start of spatial dimension  $d$ . The element  $(2, d)$  specifies the cropping applied to the end of spatial dimension  $d$ . For example, in 2-D the format is [top, left; bottom, right].

Example: 'Cropping', 'same'

Data Types: single | double

## **Output Arguments**

### **dLY — Feature map**

dlarray

Feature map, returned as a dlarray. The output dLY has the same underlying data type as the input dLX.

If the input data `d1X` is a formatted `d1array`, `d1Y` has the same dimension labels as `d1X`. If the input data is not a formatted `d1array`, `d1Y` is an unformatted `d1array` or numeric array with the same dimension order as the input data.

The size of the 'C' channel dimension of `d1Y` depends on the size of the `weights` input. The size of the 'C' dimension of output `Y` is the product of the size of the dimensions `numFiltersPerGroup` and `numGroups` in the `weights` argument. If `weights` is a formatted `d1array`, this product is the same as the product of the size of the 'C' dimension and the second 'U' dimension.

## Extended Capabilities

### GPU Arrays

Accelerate code by running on a graphics processing unit (GPU) using Parallel Computing Toolbox™.

Usage notes and limitations:

- When at least one of the following input arguments is a `gpuArray` or a `d1array` with underlying data of type `gpuArray`, this function runs on the GPU.
  - `d1X`
  - `weights`
  - `bias`

For more information, see “Run MATLAB Functions on a GPU” (Parallel Computing Toolbox).

### See Also

`avgpool` | `d1array` | `d1conv` | `d1feval` | `d1gradient` | `maxpool` | `maxunpool`

### Topics

“Define Custom Training Loops, Loss Functions, and Networks”  
“Train Network Using Model Function”

**Introduced in R2019b**



# disconnectLayers

Disconnect layers in layer graph

## Syntax

```
newlgraph = disconnectLayers(lgraph,s,d)
```

## Description

`newlgraph = disconnectLayers(lgraph,s,d)` disconnects the source layer `s` from the destination layer `d` in the layer graph `lgraph`. The new layer graph, `newlgraph`, contains the same layers as `lgraph`, but excludes the connection between `s` and `d`.

## Examples

### Disconnect Layers in Layer Graph

Create a layer graph from an array of layers.

```
layers = [  
    imageInputLayer([28 28 1], 'Name', 'input')  
    convolution2dLayer(3,16, 'Padding', 'same', 'Name', 'conv_1')  
    batchNormalizationLayer('Name', 'BN_1')  
    reluLayer('Name', 'relu_1')];  
  
lgraph = layerGraph(layers);  
figure  
plot(lgraph)
```

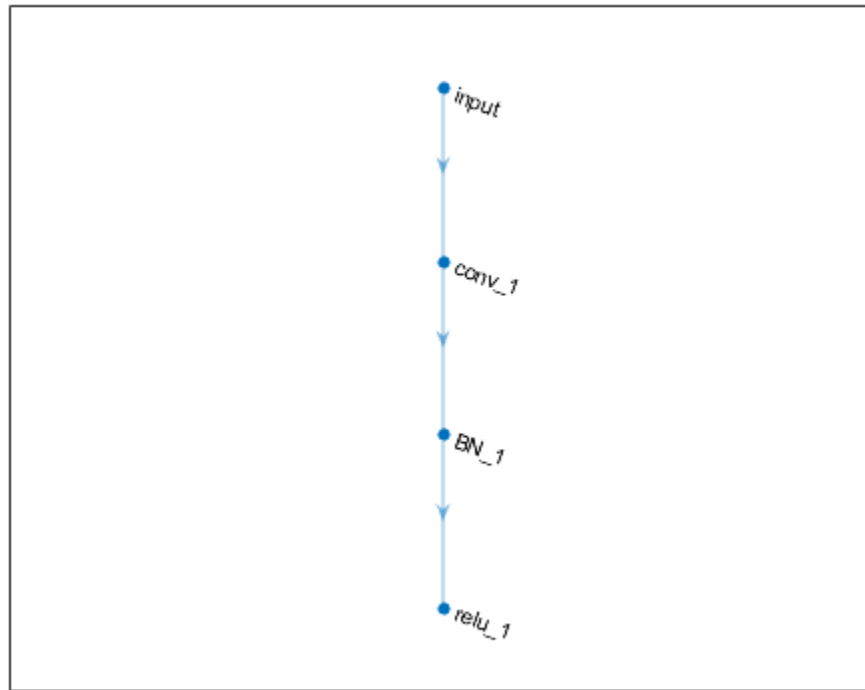

Disconnect the 'conv\_1' layer from the 'BN\_1' layer.

```
lgraph = disconnectLayers(lgraph, 'conv_1', 'BN_1');  
figure  
plot(lgraph)
```

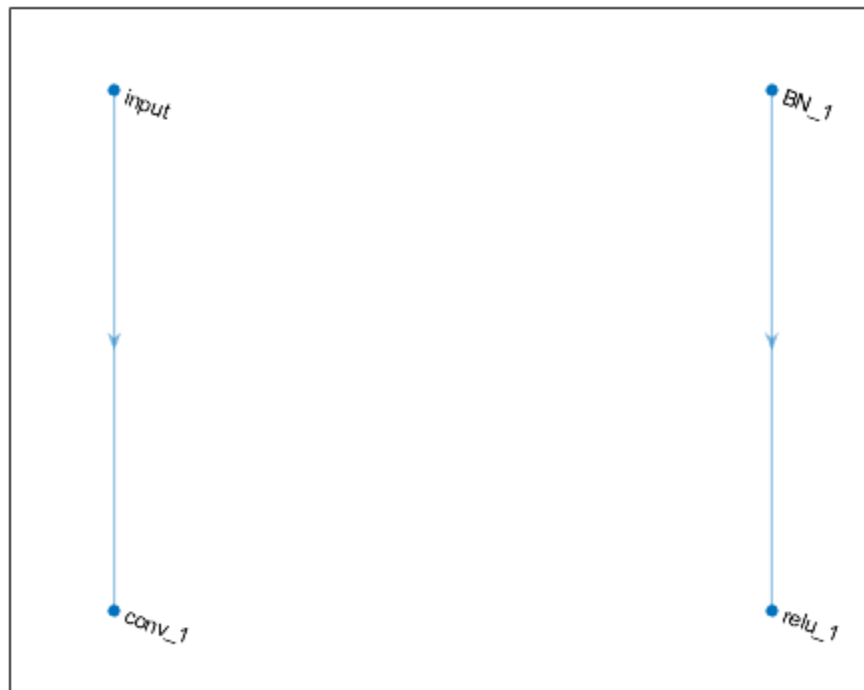

## Input Arguments

### **lgraph** — Layer graph

LayerGraph object

Layer graph, specified as a LayerGraph object. To create a layer graph, use `layerGraph`.

### **s** — Connection source

character vector | string scalar

Connection source, specified as a character vector or a string scalar.

- If the source layer has a single output, then `s` is the name of the layer.
- If the source layer has multiple outputs, then `s` is the layer name followed by the character `/` and the name of the layer output: `'layerName/outputName'`.

Example: `'conv1'`

Example: `'mpool/indices'`

### **d** — Connection destination

character vector | string scalar

Connection destination, specified as a character vector or a string scalar.

- If the destination layer has a single input, then `d` is the name of the layer.
- If the destination layer has multiple inputs, then `d` is the layer name followed by the character `/` and the name of the layer input: `'layerName/inputName'`.

Example: `'fc'`

Example: `'addlayer1/in2'`

## Output Arguments

### **newLgraph** — Output layer graph

LayerGraph object

Output layer graph, returned as a LayerGraph object.

## See Also

`addLayers` | `assembleNetwork` | `connectLayers` | `layerGraph` | `plot` | `removeLayers` | `replaceLayer`

## Topics

“Train Residual Network for Image Classification”

“Train Deep Learning Network to Classify New Images”

**Introduced in R2017b**

# dropoutLayer

Dropout layer

## Description

A dropout layer randomly sets input elements to zero with a given probability.

## Creation

### Syntax

```
layer = dropoutLayer
layer = dropoutLayer(probability)
layer = dropoutLayer( ____, 'Name', Name)
```

### Description

`layer = dropoutLayer` creates a dropout layer.

`layer = dropoutLayer(probability)` creates a dropout layer and sets the `Probability` property.

`layer = dropoutLayer( ____, 'Name', Name)` sets the optional `Name` property using a name-value pair and any of the arguments in the previous syntaxes. For example, `dropoutLayer(0.4, 'Name', 'drop1')` creates a dropout layer with dropout probability 0.4 and name 'drop1'. Enclose the property name in single quotes.

## Properties

### Dropout

#### Probability — Probability to drop out input elements

0.5 (default) | numeric scalar in the range 0 to 1

Probability for dropping out input elements, specified as a numeric scalar in the range 0-1.

At training time, the layer randomly sets input elements to zero given by the dropout mask  $\text{rand}(\text{size}(X)) < \text{Probability}$ , where  $X$  is the layer input and then scales the remaining elements by  $1/(1-\text{Probability})$ . This operation effectively changes the underlying network architecture between iterations and helps prevent the network from overfitting [1], [2]. A higher number results in more elements being dropped during training. At prediction time, the output of the layer is equal to its input.

For image input, the layer applies a different mask for each channel of each image. For sequence input, the layer applies a different dropout mask for each time step of each sequence.

Example: 0.4

## Layer

### Name — Layer name

' ' (default) | character vector | string scalar

Layer name, specified as a character vector or a string scalar. To include a layer in a layer graph, you must specify a nonempty unique layer name. If you train a series network with the layer and Name is set to ' ', then the software automatically assigns a name to the layer at training time.

Data Types: char | string

### NumInputs — Number of inputs

1 (default)

Number of inputs of the layer. This layer accepts a single input only.

Data Types: double

### InputNames — Input names

{ 'in' } (default)

Input names of the layer. This layer accepts a single input only.

Data Types: cell

### NumOutputs — Number of outputs

1 (default)

Number of outputs of the layer. This layer has a single output only.

Data Types: double

### OutputNames — Output names

{ 'out' } (default)

Output names of the layer. This layer has a single output only.

Data Types: cell

## Examples

### Create Dropout Layer

Create a dropout layer with name 'drop1'.

```
layer = dropoutLayer('Name','drop1')
```

```
layer =
```

```
  DropoutLayer with properties:
```

```
    Name: 'drop1'
```

```
  Hyperparameters
```

```
    Probability: 0.5000
```

Include a dropout layer in a Layer array.

```
layers = [ ...
    imageInputLayer([28 28 1])
    convolution2dLayer(5,20)
    reluLayer
    dropoutLayer
    fullyConnectedLayer(10)
    softmaxLayer
    classificationLayer]
```

```
layers =
    7x1 Layer array with layers:
```

1	''	Image Input	28x28x1 images with 'zerocenter' normalization
2	''	Convolution	20 5x5 convolutions with stride [1 1] and padding [0 0]
3	''	ReLU	ReLU
4	''	Dropout	50% dropout
5	''	Fully Connected	10 fully connected layer
6	''	Softmax	softmax
7	''	Classification Output	crossentropyex

## More About

### Dropout Layer

A dropout layer randomly sets input elements to zero with a given probability.

At training time, the layer randomly sets input elements to zero given by the dropout mask  $\text{rand}(\text{size}(X)) < \text{Probability}$ , where  $X$  is the layer input and then scales the remaining elements by  $1/(1-\text{Probability})$ . This operation effectively changes the underlying network architecture between iterations and helps prevent the network from overfitting [1], [2]. A higher number results in more elements being dropped during training. At prediction time, the output of the layer is equal to its input.

Similar to max or average pooling layers, no learning takes place in this layer.

For image input, the layer applies a different mask for each channel of each image. For sequence input, the layer applies a different dropout mask for each time step of each sequence.

## References

- [1] Srivastava, N., G. Hinton, A. Krizhevsky, I. Sutskever, R. Salakhutdinov. "Dropout: A Simple Way to Prevent Neural Networks from Overfitting." *Journal of Machine Learning Research*. Vol. 15, pp. 1929-1958, 2014.
- [2] Krizhevsky, A., I. Sutskever, and G. E. Hinton. "ImageNet Classification with Deep Convolutional Neural Networks." *Advances in Neural Information Processing Systems*. Vol. 25, 2012.

## Extended Capabilities

### GPU Code Generation

Generate CUDA® code for NVIDIA® GPUs using GPU Coder™.

## **See Also**

imageInputLayer | reluLayer

## **Topics**

“Create Simple Deep Learning Network for Classification”

“Train Convolutional Neural Network for Regression”

“Deep Learning in MATLAB”

“Specify Layers of Convolutional Neural Network”

“List of Deep Learning Layers”

**Introduced in R2016a**



# eluLayer

Exponential linear unit (ELU) layer

## Description

An ELU activation layer performs the identity operation on positive inputs and an exponential nonlinearity on negative inputs.

The layer performs the following operation:

$$f(x) = \begin{cases} x, & x \geq 0 \\ \alpha(\exp(x) - 1), & x < 0 \end{cases}$$

The default value of  $\alpha$  is 1. Specify a value of  $\alpha$  for the layer by setting the Alpha property.

## Creation

### Syntax

```
layer = eluLayer
layer = eluLayer(alpha)
layer = eluLayer( ____, 'Name', Name)
```

### Description

`layer = eluLayer` creates an ELU layer.

`layer = eluLayer(alpha)` creates an ELU layer and specifies the Alpha property.

`layer = eluLayer( ____, 'Name', Name)` additionally sets the optional Name property using any of the previous syntaxes. For example, `eluLayer('Name', 'elu1')` creates an ELU layer with the name 'elu1'.

## Properties

### ELU

#### Alpha — Nonlinearity parameter

1 (default) | numeric scalar

Nonlinearity parameter  $\alpha$ , specified as a numeric scalar. The minimum value of the output of the ELU layer equals  $-\alpha$  and the slope at negative inputs approaching 0 is  $\alpha$ .

### Layer

#### Name — Layer name

' ' (default) | character vector | string scalar

Layer name, specified as a character vector or a string scalar. To include a layer in a layer graph, you must specify a nonempty unique layer name. If you train a series network with the layer and Name is set to ' ', then the software automatically assigns a name to the layer at training time.

Data Types: `char` | `string`

**NumInputs — Number of inputs**

1 (default)

Number of inputs of the layer. This layer accepts a single input only.

Data Types: `double`

**InputNames — Input names**

{'in'} (default)

Input names of the layer. This layer accepts a single input only.

Data Types: `cell`

**NumOutputs — Number of outputs**

1 (default)

Number of outputs of the layer. This layer has a single output only.

Data Types: `double`

**OutputNames — Output names**

{'out'} (default)

Output names of the layer. This layer has a single output only.

Data Types: `cell`

## Examples

**Create ELU Layer**

Create an exponential linear unit (ELU) layer with the name 'elu1' and a default value of 1 for the nonlinearity parameter Alpha.

```
layer = eluLayer('Name','elu1')
```

```
layer =  
  ELULayer with properties:
```

```
    Name: 'elu1'  
    Alpha: 1
```

```
    Show all properties
```

Include an ELU layer in a Layer array.

```
layers = [  
    imageInputLayer([28 28 1])  
    convolution2dLayer(3,16)
```

```

batchNormalizationLayer
eluLayer

maxPooling2dLayer(2, 'Stride', 2)
convolution2dLayer(3, 32)
batchNormalizationLayer
eluLayer

fullyConnectedLayer(10)
softmaxLayer
classificationLayer]

layers =
    1x1 Layer array with layers:

    1  ''  Image Input           28x28x1 images with 'zerocenter' normalization
    2  ''  Convolution          16 3x3 convolutions with stride [1 1] and padding [0 0 0]
    3  ''  Batch Normalization  Batch normalization
    4  ''  ELU                  ELU with Alpha 1
    5  ''  Max Pooling          2x2 max pooling with stride [2 2] and padding [0 0 0 0]
    6  ''  Convolution          32 3x3 convolutions with stride [1 1] and padding [0 0 0]
    7  ''  Batch Normalization  Batch normalization
    8  ''  ELU                  ELU with Alpha 1
    9  ''  Fully Connected      10 fully connected layer
    10 ''  Softmax              softmax
    11 ''  Classification Output crossentropyex

```

## References

- [1] Clevert, Djork-Arné, Thomas Unterthiner, and Sepp Hochreiter. "Fast and accurate deep network learning by exponential linear units (ELUs)." *arXiv preprint arXiv:1511.07289* (2015).

## Extended Capabilities

### GPU Code Generation

Generate CUDA® code for NVIDIA® GPUs using GPU Coder™.

## See Also

[batchNormalizationLayer](#) | [clippedReluLayer](#) | [leakyReluLayer](#) | [reluLayer](#) | [trainNetwork](#)

### Topics

- “Create Simple Deep Learning Network for Classification”
- “Train Convolutional Neural Network for Regression”
- “Deep Learning in MATLAB”
- “Specify Layers of Convolutional Neural Network”
- “List of Deep Learning Layers”

### Introduced in R2019a

# exportONNXNetwork

Export network to ONNX model format

## Syntax

```
exportONNXNetwork(net, filename)
exportONNXNetwork(net, filename, Name, Value)
```

## Description

`exportONNXNetwork(net, filename)` exports the deep learning network `net` with weights to the ONNX™ format file `filename`. If `filename` exists, then `exportONNXNetwork` overwrites the file.

This function requires the Deep Learning Toolbox Converter for ONNX Model Format support package. If this support package is not installed, then the function provides a download link.

`exportONNXNetwork(net, filename, Name, Value)` exports a network using additional options specified by one or more name-value pair arguments.

## Examples

### Export Network in ONNX Format

Load a pretrained SqueezeNet convolutional neural network.

```
net = squeezeNet
```

DAGNetwork with properties:

```
    Layers: [68×1 nnet.cnn.layer.Layer]
Connections: [75×2 table]
  InputNames: {'data'}
OutputNames: {'ClassificationLayer_predictions'}
```

Export the network as an ONNX format file in the current folder called `squeezenet.onnx`. If the Deep Learning Toolbox Converter for ONNX Model Format support package is not installed, then the function provides a link to the required support package in the Add-On Explorer. To install the support package, click the link, and then click **Install**.

```
filename = 'squeezenet.onnx';
exportONNXNetwork(net, filename)
```

Now, you can import the `squeezenet.onnx` file into any deep learning framework that supports ONNX import.

## Input Arguments

### **net** — Trained network

SeriesNetwork object | DAGNetwork object

Trained network, specified as a `SeriesNetwork` or a `DAGNetwork` object. You can get a trained network by importing a pretrained network (for example, by using the `googlenet` function) or by training your own network using `trainNetwork`.

#### **filename — Name of file**

character vector | string scalar

Name of file, specified as a character vector or string scalar.

Example: `'network.onnx'`

#### **Name-Value Pair Arguments**

Specify optional comma-separated pairs of `Name`, `Value` arguments. `Name` is the argument name and `Value` is the corresponding value. `Name` must appear inside quotes. You can specify several name and value pair arguments in any order as `Name1, Value1, ..., NameN, ValueN`.

Example: `exportONNXNetwork(net,filename,'NetworkName','my_net')` exports a network and specifies `'my_net'` as the network name in the saved ONNX network.

#### **NetworkName — Name of ONNX network**

'Network' (default) | character vector | string scalar

Name of ONNX network to store in the saved file, specified as a character vector or a string scalar.

Example: `'my_squeezenet'`

#### **OpsetVersion — Version of ONNX operator set**

8 (default) | 6 | 7 | 9

Version of ONNX operator set to use in the exported model. If the default operator set does not support the network you are trying to export, then try using a later version. If you import the exported network to another framework and you used an operator set during export that the importer does not support, then the import can fail.

Example: 6

## **Tips**

- You can export a trained MATLAB deep learning network that includes multiple inputs and multiple outputs to the ONNX model format. To learn about a multiple-input and multiple-output deep learning network, see “Multiple-Input and Multiple-Output Networks”.
- `exportONNXNetwork` does not export settings or properties related to network training such as training options, learning rate factors, or regularization factors.
- If you export a network that contains a layer that the ONNX format does not support, then `exportONNXNetwork` saves a placeholder ONNX operator in place of the unsupported layer and returns a warning. You cannot import an ONNX network with a placeholder operator into other deep learning frameworks.
- Because of architectural differences between MATLAB and ONNX, an exported network can have a different structure compared to the original network. Also, if you import an exported network, layers of a reimported network might differ from the original network.
- `exportONNXNetwork` can export the following:
  - Networks that have both convolutional and LSTM layers, for example, for video classification applications.

- All custom layers (except `nnet.onnx.layer.Flatten3dLayer`) that are created when importing networks from ONNX or TensorFlow™-Keras using Deep Learning Toolbox Converter for ONNX Model Format or Deep Learning Toolbox Importer for TensorFlow-Keras Models as in the below table.
- The following layers:

<b>ONNX Exporter Supported Layers</b>
<b>Deep Learning Toolbox Layers</b>
<code>additionLayer</code>
<code>averagePooling2dLayer</code>
<code>averagePooling3dLayer</code>
<code>batchNormalizationLayer</code>
<code>bilstmLayer</code>
<code>ClassificationOutputLayer</code>
<code>clippedReluLayer</code>
<code>concatenationLayer</code>
<code>convolution2dLayer</code>
<code>convolution3dLayer</code>
<code>crop2dLayer</code>
<code>CrossChannelNormalizationLayer</code>
<code>depthConcatenationLayer</code>
<code>dropoutLayer</code>
<code>eluLayer</code>
<code>fullyConnectedLayer</code>
<code>flattenLayer</code>
<code>globalAveragePooling2dLayer</code>
<code>globalMaxPooling2dLayer</code>
<code>groupedConvolution2dLayer</code>
<code>gruLayer</code>
<code>imageInputLayer</code>
<code>image3dInputLayer</code>
<code>leakyReluLayer</code>
<code>lstmLayer</code>
<code>maxPooling2dLayer</code>
<code>maxPooling3dLayer</code>
<code>maxUnpooling2dLayer</code>
<code>RegressionOutputLayer</code>
<code>reluLayer</code>
<code>sequenceInputLayer</code>

<b>ONNX Exporter Supported Layers</b>
softmaxLayer
tanhLayer
transposedConv2dLayer
transposedConv3dLayer
<b>ONNX Importer Custom Layers</b>
nnet.onnx.layer.ClipLayer
nnet.onnx.layer.FlattenLayer
nnet.onnx.layer.GlobalAveragePooling2dLayer
nnet.onnx.layer.IdentityLayer
nnet.onnx.layer.PReLULayer
nnet.onnx.layer.ElementwiseAffineLayer
nnet.onnx.layer.TanhLayer
<b>Keras Importer Custom Layers</b>
nnet.keras.layer.FlattenCStyleLayer
nnet.keras.layer.GlobalAveragePooling2dLayer
nnet.keras.layer.SigmoidLayer
nnet.keras.layer.TanhLayer
nnet.keras.layer.ZeroPadding2dLayer
<b>Caffe Importer Custom Layers</b>
nnet.caffe.layer.TanhLayer
<b>Computer Vision Toolbox™ Layers</b>
pixelClassificationLayer
rcnnBoxRegressionLayer
roiInputLayer
roiMaxPooling2dLayer
<b>Text Analytics Toolbox™ Layers</b>
wordEmbeddingLayer

## References

[1] *Open Neural Network Exchange*. <https://github.com/onnx/>.

[2] *ONNX*. <https://onnx.ai/>.

## **See Also**

`importCaffeLayers` | `importCaffeNetwork` | `importKerasLayers` | `importKerasNetwork` | `importONNXLayers` | `importONNXNetwork`

## **Topics**

“Pretrained Deep Neural Networks”

“Deep Learning in MATLAB”

**Introduced in R2018a**



## extractdata

Extract data from dIarray

### Syntax

```
y = extractdata(dIX)
```

### Description

`y = extractdata(dIX)` returns the data in the dIarray `dIX`. The output `y` has the same data type as the data in `dIX` and is unlabeled

### Examples

#### Extract Data from dIarray

Create a logical dIarray labeled 'SS'.

```
rng default % For reproducibility
dIX = dIarray(rand(4,3) > 0.5, 'SS')
```

```
dIX =
  4(S) x 3(S) logical dIarray
```

```
  1  1  1
  1  0  1
  0  0  0
  1  1  1
```

Extract the data from dIX.

```
y = extractdata(dIX)
```

```
y = 4x3 logical array
```

```
  1  1  1
  1  0  1
  0  0  0
  1  1  1
```

### Input Arguments

#### dIX — Input dIarray

dIarray object

Input dIarray, specified as a dIarray object.

Example: `dIX = dIarray(randn(50,3), 'SC')`

## Output Arguments

### **y** — Data array

single array | double array | logical array | gpuArray

Data array, returned as a single, double, or logical array, or as a `gpuArray` of one of these array types. The output `y` has the same data type as the underlying data type in `d\X`. The output `y` is unlabeled.

## Tips

- If `d\X` contains an implicit permutation because of labeling, `y` has that permutation explicitly.
- The output `y` has no tracing for the computation of derivatives. See “Derivative Trace”.

## See Also

`dlarray` | `gather`

**Introduced in R2019b**

## finddim

Find dimensions with specified label

### Syntax

```
dim = finddim(dlX,label)
```

### Description

`dim = finddim(dlX,label)` returns the dimensions in `dlX` that have the label `label`. If no dimension matches `label`, `dim` is empty.

### Examples

#### Obtain Dimension with Specified Labels

Create a `dlarray` with some repeated labels. Specify the labels as 'TSSU'. The `dlarray` call reorders the labels, because it enforces the order 'SCBTU'. See "Usage" on page 1-292.

```
dlX = dlarray(randn(5,4,3,2), 'TSSU');
```

Obtain the dimensions with the label 'T'.

```
dimU = finddim(dlX, 'T')
```

```
dimU = 3
```

Obtain the dimensions with the label 'S'.

```
dimS = finddim(dlX, 'S')
```

```
dimS = 1×2
```

```
    1    2
```

Obtain the dimensions with the label 'B'.

```
dimB = finddim(dlX, 'B')
```

```
dimB =
```

```
    1×0 empty double row vector
```

Obtain the size of the `dlX` dimensions labeled 'S'.

```
Ssize = size(dlX, finddim(dlX, 'S'))
```

```
Ssize = 1×2
```

```
    4    3
```

## Input Arguments

### **d1X** — Input d1array

d1array object

Input d1array, specified as a d1array object.

Example: `d1X = d1array(randn(3,4), 'ST')`

### **label** — Single d1array label

'S' | 'C' | 'B' | 'T' | 'U'

Single d1array label, specified as one of these characters:

- S — Spatial
- C — Channel
- B — Batch observations
- T — Time or sequence
- U — Unspecified

Example: "C"

Data Types: char | string

## Output Arguments

### **dim** — Dimension

real vector

Dimension, returned as a real vector. If no label in the input array d1X matches label, dim is empty. So if d1X is unlabeled, dim is empty.

## See Also

`dims` | `d1array` | `stripdims`

**Introduced in R2019b**

# findPlaceholderLayers

Find placeholder layers in network architecture imported from Keras or ONNX

## Syntax

```
placeholderLayers = findPlaceholderLayers(importedLayers)
[placeholderLayers,indices] = findPlaceholderLayers(importedLayers)
```

## Description

`placeholderLayers = findPlaceholderLayers(importedLayers)` returns all placeholder layers that exist in the network architecture `importedLayers` imported by the `importKerasLayers` or `importONNXLayers` functions, or created by the `functionToLayerGraph` function. Placeholder layers are the layers that these functions insert in place of layers that are not supported by Deep Learning Toolbox.

To use with an imported network, this function requires either the Deep Learning Toolbox Importer for TensorFlow-Keras Models support package or the Deep Learning Toolbox Converter for ONNX Model Format support package.

`[placeholderLayers,indices] = findPlaceholderLayers(importedLayers)` also returns the indices of the placeholder layers.

## Examples

### Find and Explore Placeholder Layers

Specify the Keras network file to import layers from.

```
modelfile = 'digitsDAGnetwithnoise.h5';
```

Import the network architecture. The network includes some layer types that are not supported by Deep Learning Toolbox. The `importKerasLayers` function replaces each unsupported layer with a placeholder layer and returns a warning message.

```
lgraph = importKerasLayers(modelfile)
```

```
Warning: Unable to import some Keras layers, because they are not yet supported by the Deep Learning
Toolbox. They have been replaced by placeholder layers. To find these layers, call the function
findPlaceholderLayers on the returned object.
> In nnet.internal.cnn.keras.importKerasLayers (line 26)
   In importKerasLayers (line 102)
```

```
lgraph =
```

```
LayerGraph with properties:
```

```
Layers: [15x1 nnet.cnn.layer.Layer]
Connections: [15x2 table]
```

Display the imported layers of the network. Two placeholder layers replace the Gaussian noise layers in the Keras network.

```
lgraph.Layers
```

```
ans =
15x1 Layer array with layers:
 1 'input_1'           Image Input           28x28x1 images
 2 'conv2d_1'         Convolution           20 7x7 convolutions with stride [1 1] and padding 'same'
 3 'conv2d_1_relu'    ReLU                  ReLU
 4 'conv2d_2'         Convolution           20 3x3 convolutions with stride [1 1] and padding 'same'
 5 'conv2d_2_relu'    ReLU                  ReLU
 6 'gaussian_noise_1' PLACEHOLDER LAYER    Placeholder for 'GaussianNoise' Keras layer
 7 'gaussian_noise_2' PLACEHOLDER LAYER    Placeholder for 'GaussianNoise' Keras layer
 8 'max_pooling2d_1'  Max Pooling           2x2 max pooling with stride [2 2] and padding 'same'
 9 'max_pooling2d_2'  Max Pooling           2x2 max pooling with stride [2 2] and padding 'same'
10 'flatten_1'        Keras Flatten         Flatten activations into 1D assuming C-style (row-major) order
11 'flatten_2'        Keras Flatten         Flatten activations into 1D assuming C-style (row-major) order
12 'concatenate_1'    Depth concatenation    Depth concatenation of 2 inputs
13 'dense_1'          Fully Connected       10 fully connected layer
14 'activation_1_softmax' Softmax                softmax
15 'ClassificationLayer_activation_1' Classification Output  crossentropyex
```

Find the placeholder layers using `findPlaceholderLayers`. The output argument contains the two placeholder layers that `importKerasLayers` inserted in place of the Gaussian noise layers of the Keras network.

```
placeholders = findPlaceholderLayers(lgraph)
```

```
placeholders =
2x1 PlaceholderLayer array with layers:
 1 'gaussian_noise_1' PLACEHOLDER LAYER Placeholder for 'GaussianNoise' Keras layer
 2 'gaussian_noise_2' PLACEHOLDER LAYER Placeholder for 'GaussianNoise' Keras layer
```

Display the configuration of each placeholder layer.

```
gaussian1.KerasConfiguration
gaussian2.KerasConfiguration

ans =
struct with fields:
    trainable: 1
        name: 'gaussian_noise_1'
        stddev: 1.5000
```

```
ans =
struct with fields:
    trainable: 1
        name: 'gaussian_noise_2'
        stddev: 0.7000
```

## Assemble Network from Pretrained Keras Layers

This example shows how to import the layers from a pretrained Keras network, replace the unsupported layers with custom layers, and assemble the layers into a network ready for prediction.

## Import Keras Network

Import the layers from a Keras network model. The network in 'digitsDAGnetwithnoise.h5' classifies images of digits.

```
filename = 'digitsDAGnetwithnoise.h5';
lgraph = importKerasLayers(filename, 'ImportWeights', true);
```

Warning: Unable to import some Keras layers, because they are not yet supported by the Deep Learning Toolbox.

The Keras network contains some layers that are not supported by Deep Learning Toolbox. The `importKerasLayers` function displays a warning and replaces the unsupported layers with placeholder layers.

Plot the layer graph using `plot`.

```
figure
plot(lgraph)
title("Imported Network")
```

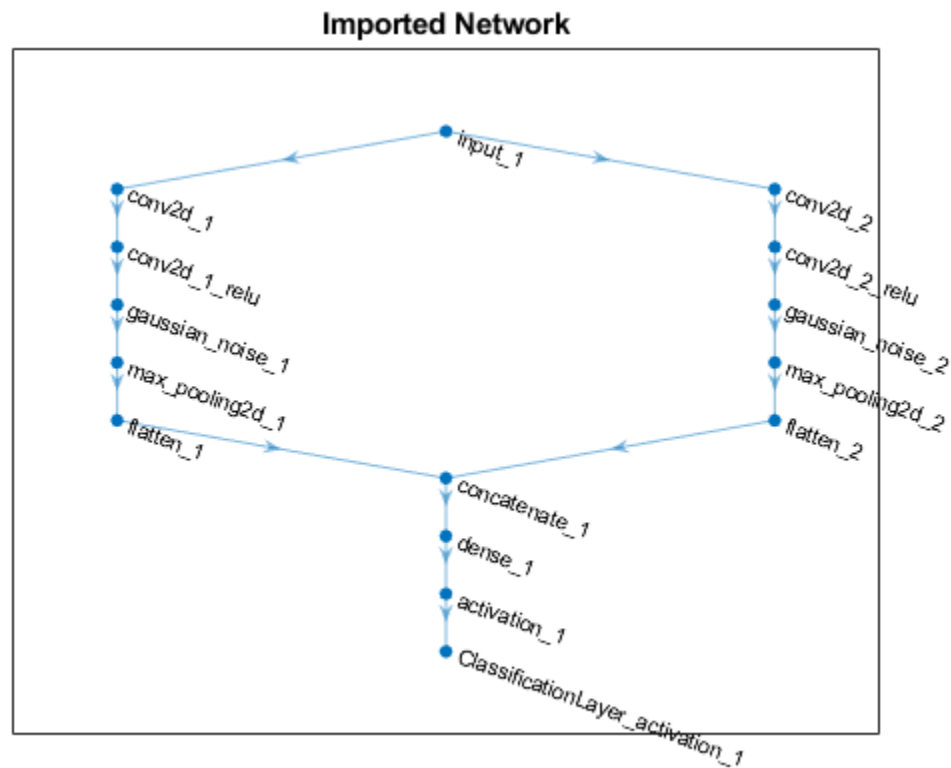

## Replace Placeholder Layers

To replace the placeholder layers, first identify the names of the layers to replace. Find the placeholder layers using `findPlaceholderLayers`.

```
placeholderLayers = findPlaceholderLayers(lgraph)
```

```
placeholderLayers =
    2x1 PlaceholderLayer array with layers:
```

```
1 'gaussian_noise_1' PLACEHOLDER LAYER Placeholder for 'GaussianNoise' Keras layer
2 'gaussian_noise_2' PLACEHOLDER LAYER Placeholder for 'GaussianNoise' Keras layer
```

Display the Keras configurations of these layers.

```
placeholderLayers.KerasConfiguration
```

```
ans = struct with fields:
    trainable: 1
    name: 'gaussian_noise_1'
    stddev: 1.5000
```

```
ans = struct with fields:
    trainable: 1
    name: 'gaussian_noise_2'
    stddev: 0.7000
```

Define a custom Gaussian noise layer. To create this layer, save the file `gaussianNoiseLayer.m` in the current folder. Then, create two Gaussian noise layers with the same configurations as the imported Keras layers.

```
gnLayer1 = gaussianNoiseLayer(1.5, 'new_gaussian_noise_1');
gnLayer2 = gaussianNoiseLayer(0.7, 'new_gaussian_noise_2');
```

Replace the placeholder layers with the custom layers using `replaceLayer`.

```
lgraph = replaceLayer(lgraph, 'gaussian_noise_1', gnLayer1);
lgraph = replaceLayer(lgraph, 'gaussian_noise_2', gnLayer2);
```

Plot the updated layer graph using `plot`.

```
figure
plot(lgraph)
title("Network with Replaced Layers")
```



Network with Replaced Layers

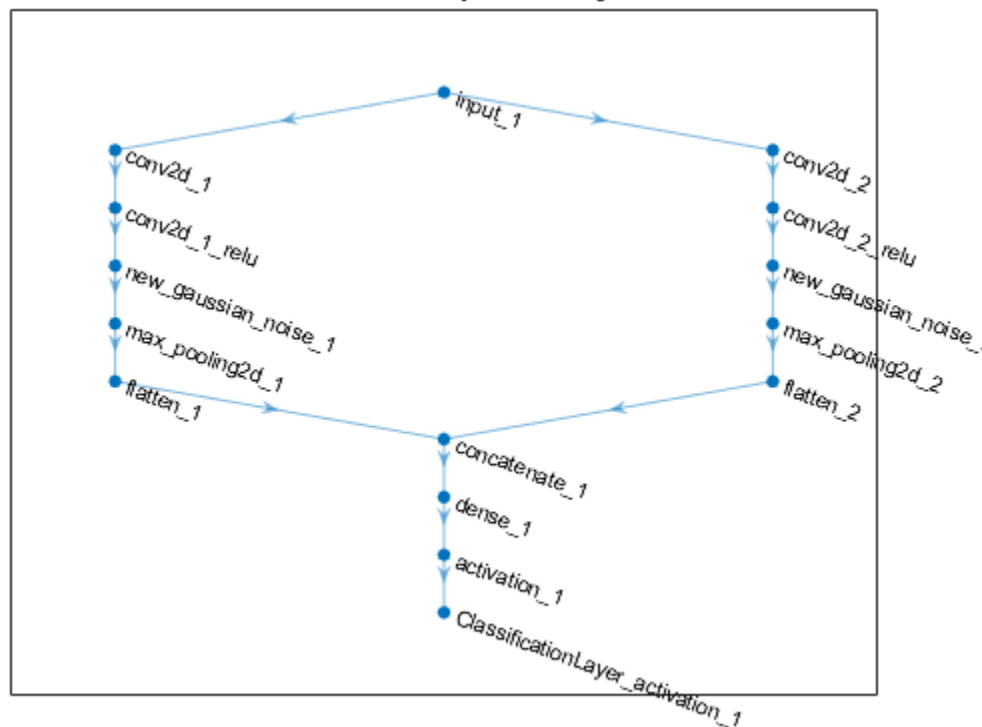

### Specify Class Names

If the imported classification layer does not contain the classes, then you must specify these before prediction. If you do not specify the classes, then the software automatically sets the classes to 1, 2, ..., N, where N is the number of classes.

Find the index of the classification layer by viewing the Layers property of the layer graph.

```
lgraph.Layers
```

```
ans =
```

```
15x1 Layer array with layers:
```

1	'input_1'	Image Input	28x28x1 images
2	'conv2d_1'	Convolution	20 7x7x1 convolutions with
3	'conv2d_1_relu'	ReLU	ReLU
4	'conv2d_2'	Convolution	20 3x3x1 convolutions with
5	'conv2d_2_relu'	ReLU	ReLU
6	'new_gaussian_noise_1'	Gaussian Noise	Gaussian noise with standar
7	'new_gaussian_noise_2'	Gaussian Noise	Gaussian noise with standar
8	'max_pooling2d_1'	Max Pooling	2x2 max pooling with strid
9	'max_pooling2d_2'	Max Pooling	2x2 max pooling with strid
10	'flatten_1'	Keras Flatten	Flatten activations into 1
11	'flatten_2'	Keras Flatten	Flatten activations into 1
12	'concatenate_1'	Depth concatenation	Depth concatenation of 2 in
13	'dense_1'	Fully Connected	10 fully connected layer
14	'activation_1'	Softmax	softmax
15	'ClassificationLayer_activation_1'	Classification Output	crossentropyex

The classification layer has the name 'ClassificationLayer\_activation\_1'. View the classification layer and check the Classes property.

```
cLayer = lgraph.Layers(end)

cLayer =
  ClassificationOutputLayer with properties:

      Name: 'ClassificationLayer_activation_1'
      Classes: 'auto'
      OutputSize: 'auto'

  Hyperparameters
      LossFunction: 'crossentropyex'
```

Because the Classes property of the layer is 'auto', you must specify the classes manually. Set the classes to 0, 1, ..., 9, and then replace the imported classification layer with the new one.

```
cLayer.Classes = string(0:9)

cLayer =
  ClassificationOutputLayer with properties:

      Name: 'ClassificationLayer_activation_1'
      Classes: [0 1 2 3 4 5 6 7 8 9]
      OutputSize: 10

  Hyperparameters
      LossFunction: 'crossentropyex'
```

```
lgraph = replaceLayer(lgraph, 'ClassificationLayer_activation_1', cLayer);
```

### Assemble Network

Assemble the layer graph using `assembleNetwork`. The function returns a `DAGNetwork` object that is ready to use for prediction.

```
net = assembleNetwork(lgraph)

net =
  DAGNetwork with properties:

      Layers: [15×1 nnet.cnn.layer.Layer]
      Connections: [15×2 table]
      InputNames: {'input_1'}
      OutputNames: {'ClassificationLayer_activation_1'}
```

### Input Arguments

#### **importedLayers** — Network architecture imported from Keras or ONNX or created by `functionToLayerGraph`

Layer array | LayerGraph object

Network architecture imported from Keras or ONNX or created by `functionToLayerGraph`, specified as a Layer array or LayerGraph object.

## Output Arguments

### **placeholderLayers** — All placeholder layers in network architecture

array of PlaceholderLayer objects

All placeholder layers in the network architecture, returned as an array of PlaceholderLayer objects.

### **indices** — Indices of placeholder layers

vector

Indices of placeholder layers, returned as a vector.

- If `importedLayers` is a layer array, then `indices` are the indices of the placeholder layers in `importedLayers`.
- If `importedLayers` is a LayerGraph object, then `indices` are the indices of the placeholder layers in `importedLayers.Layers`.

If you remove a layer from or add a layer to a Layer array or LayerGraph object, then the indices of the other layers in the object can change. You must use `findPlaceholderLayers` again to find the updated indices of the rest of the placeholder layers.

## Tips

- If you have installed Deep Learning Toolbox Importer for TensorFlow-Keras Models and `findPlaceholderLayers` is unable to find placeholder layers created when importing an ONNX network, then try updating the Deep Learning Toolbox Importer for TensorFlow-Keras Models support package in the Add-On Explorer.

## See Also

PlaceholderLayer | assembleNetwork | functionToLayerGraph | importKerasLayers | importONNXLayers | replaceLayer

## Topics

“List of Deep Learning Layers”

“Define Custom Deep Learning Layers”

“Define Custom Deep Learning Layer with Learnable Parameters”

“Check Custom Layer Validity”

“Assemble Network from Pretrained Keras Layers”

## Introduced in R2017b

# flattenLayer

Flatten layer

## Description

A flatten layer collapses the spatial dimensions of the input into the channel dimension.

For example, if the input to the layer is an  $H$ -by- $W$ -by- $C$ -by- $N$ -by- $S$  array (sequences of images), then the flattened output is an  $(H*W*C)$ -by- $N$ -by- $S$  array.

This layer supports sequence input only.

## Creation

### Syntax

```
layer = flattenLayer  
layer = flattenLayer('Name',Name)
```

### Description

`layer = flattenLayer` creates a flatten layer.

`layer = flattenLayer('Name',Name)` sets the optional `Name` property using a name-value pair. For example, `flattenLayer('Name','flatten1')` creates a flatten layer with name 'flatten1'.

## Properties

### Name — Layer name

' ' (default) | character vector | string scalar

Layer name, specified as a character vector or a string scalar. To include a layer in a layer graph, you must specify a nonempty unique layer name. If you train a series network with the layer and `Name` is set to ' ', then the software automatically assigns a name to the layer at training time.

Data Types: `char` | `string`

### NumInputs — Number of inputs

1 (default)

Number of inputs of the layer. This layer accepts a single input only.

Data Types: `double`

### InputNames — Input names

{'in'} (default)

Input names of the layer. This layer accepts a single input only.

Data Types: cell

### **NumOutputs — Number of outputs**

1 (default)

Number of outputs of the layer. This layer has a single output only.

Data Types: double

### **OutputNames — Output names**

{ 'out' } (default)

Output names of the layer. This layer has a single output only.

Data Types: cell

## **Object Functions**

### **Examples**

#### **Create Flatten Layer**

Create a flatten layer with the name 'flatten1'.

```
layer = flattenLayer('Name', 'flatten1')
```

```
layer =  
  FlattenLayer with properties:
```

```
  Name: 'flatten1'
```

#### **Create Network for Video Classification**

Create a deep learning network for data containing sequences of images, such as video and medical image data.

- To input sequences of images into a network, use a sequence input layer.
- To apply convolutional operations independently to each time step, first convert the sequences of images to an array of images using a sequence folding layer.
- To restore the sequence structure after performing these operations, convert this array of images back to image sequences using a sequence unfolding layer.
- To convert images to feature vectors, use a flatten layer.

You can then input vector sequences into LSTM and BiLSTM layers.

#### **Define Network Architecture**

Create a classification LSTM network that classifies sequences of 28-by-28 grayscale images into 10 classes.

Define the following network architecture:

- A sequence input layer with an input size of [28 28 1].
- A convolution, batch normalization, and ReLU layer block with 20 5-by-5 filters.
- An LSTM layer with 200 hidden units that outputs the last time step only.
- A fully connected layer of size 10 (the number of classes) followed by a softmax layer and a classification layer.

To perform the convolutional operations on each time step independently, include a sequence folding layer before the convolutional layers. LSTM layers expect vector sequence input. To restore the sequence structure and reshape the output of the convolutional layers to sequences of feature vectors, insert a sequence unfolding layer and a flatten layer between the convolutional layers and the LSTM layer.

```
inputSize = [28 28 1];
filterSize = 5;
numFilters = 20;
numHiddenUnits = 200;
numClasses = 10;

layers = [ ...
    sequenceInputLayer(inputSize, 'Name', 'input')

    sequenceFoldingLayer('Name', 'fold')

    convolution2dLayer(filterSize, numFilters, 'Name', 'conv')
    batchNormalizationLayer('Name', 'bn')
    reluLayer('Name', 'relu')

    sequenceUnfoldingLayer('Name', 'unfold')
    flattenLayer('Name', 'flatten')

    lstmLayer(numHiddenUnits, 'OutputMode', 'last', 'Name', 'lstm')

    fullyConnectedLayer(numClasses, 'Name', 'fc')
    softmaxLayer('Name', 'softmax')
    classificationLayer('Name', 'classification')];
```

Convert the layers to a layer graph and connect the `miniBatchSize` output of the sequence folding layer to the corresponding input of the sequence unfolding layer.

```
lgraph = layerGraph(layers);
lgraph = connectLayers(lgraph, 'fold/miniBatchSize', 'unfold/miniBatchSize');
```

View the final network architecture using the `plot` function.

```
figure
plot(lgraph)
```

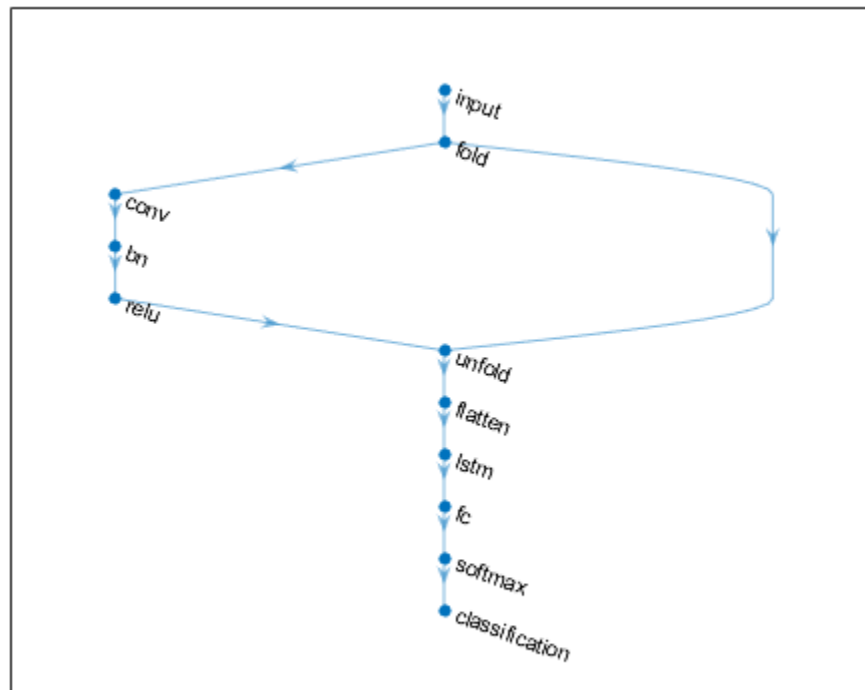

## Extended Capabilities

### GPU Code Generation

Generate CUDA® code for NVIDIA® GPUs using GPU Coder™.

### See Also

[bilstmLayer](#) | [classifyAndUpdateState](#) | [gruLayer](#) | [lstmLayer](#) | [predictAndUpdateState](#) | [resetState](#) | [sequenceFoldingLayer](#) | [sequenceInputLayer](#) | [sequenceUnfoldingLayer](#)

### Topics

“Classify Videos Using Deep Learning”  
 “Sequence Classification Using Deep Learning”  
 “Time Series Forecasting Using Deep Learning”  
 “Sequence-to-Sequence Classification Using Deep Learning”  
 “Visualize Activations of LSTM Network”  
 “Long Short-Term Memory Networks”  
 “Deep Learning in MATLAB”  
 “List of Deep Learning Layers”

### Introduced in R2019a

## forward

Compute deep learning network output for training

### Syntax

```
dLY = forward(dlnet,dlX)
dLY = forward(dlnet,dlX1,...,dlXM)
[dLY1,...,dLYN] = forward( ___ )
[dLY1,...,dLYK] = forward( ___ , 'Outputs' , layerNames)
[ ___ ,state] = forward( ___ )
```

### Description

Some deep learning layers behave differently during training and inference (prediction). For example, during training, dropout layers randomly set input elements to zero to help prevent overfitting, but during inference, dropout layers do not change the input.

To compute network outputs for training, use the `forward` function. To compute network outputs for inference, use the `predict` function.

`dLY = forward(dlnet,dlX)` returns the network output `dLY` during training given the input data `dlX`.

`dLY = forward(dlnet,dlX1,...,dlXM)` returns the network output `dLY` during training given the `M` inputs `dlX1, ..., dlXM` and the network `dlnet` that has `M` inputs and a single output.

`[dLY1,...,dLYN] = forward( ___ )` returns the `N` outputs `dLY1, ..., dLYN` during training for networks that have `N` outputs using any of the previous syntaxes.

`[dLY1,...,dLYK] = forward( ___ , 'Outputs' , layerNames)` returns the outputs `dLY1, ..., dLYK` during training for the specified layers using any of the previous syntaxes.

`[ ___ ,state] = forward( ___ )` also returns the updated network state using any of the previous syntaxes.

### Examples

#### Train Network Using Custom Training Loop

This example shows how to train a network that classifies handwritten digits with a custom learning rate schedule.

If `trainingOptions` does not provide the options you need (for example, a custom learning rate schedule), then you can define your own custom training loop using automatic differentiation.

This example trains a network to classify handwritten digits with the *time-based decay* learning rate schedule: for each iteration, the solver uses the learning rate given by  $\rho_t = \frac{\rho_0}{1+k_t}$ , where  $t$  is the iteration number,  $\rho_0$  is the initial learning rate, and  $k$  is the decay.



## Load Training Data

Load the digits data.

```
[XTrain,YTrain] = digitTrain4DArrayData;
classes = categories(YTrain);
numClasses = numel(classes);
```

## Define Network

Define the network and specify the average image using the 'Mean' option in the image input layer.

```
layers = [
    imageInputLayer([28 28 1], 'Name', 'input', 'Mean', mean(XTrain,4))
    convolution2dLayer(5, 20, 'Name', 'conv1')
    batchNormalizationLayer('Name','bn1')
    reluLayer('Name', 'relu1')
    convolution2dLayer(3, 20, 'Padding', 1, 'Name', 'conv2')
    batchNormalizationLayer('Name','bn2')
    reluLayer('Name', 'relu2')
    convolution2dLayer(3, 20, 'Padding', 1, 'Name', 'conv3')
    batchNormalizationLayer('Name','bn3')
    reluLayer('Name', 'relu3')
    fullyConnectedLayer(numClasses, 'Name', 'fc')
    softmaxLayer('Name','softmax')];
lgraph = layerGraph(layers);
```

Create a `dlnetwork` object from the layer graph.

```
dlnet = dlnetwork(lgraph)
```

```
dlnet =
```

```
  dlnetwork with properties:
```

```
    Layers: [12x1 nnet.cnn.layer.Layer]
Connections: [11x2 table]
 Learnables: [14x3 table]
    State: [6x3 table]
 InputNames: {'input'}
OutputNames: {'softmax'}
```

## Define Model Gradients Function

Create the function `modelGradients`, listed at the end of the example, that takes a `dlnetwork` object `dlnet`, a mini-batch of input data `dlX` with corresponding labels `Y` and returns the gradients of the loss with respect to the learnable parameters in `dlnet` and the corresponding loss.

## Specify Training Options

Train with a minibatch size of 128 for 5 epochs.

```
numEpochs = 5;
miniBatchSize = 128;
```

Specify the options for SGDM optimization. Specify an initial learn rate of 0.01 with a decay of 0.01, and momentum 0.9.

```
initialLearnRate = 0.01;  
decay = 0.01;  
momentum = 0.9;
```

Visualize the training progress in a plot.

```
plots = "training-progress";
```

Train on a GPU if one is available. Using a GPU requires Parallel Computing Toolbox™ and a CUDA® enabled NVIDIA® GPU with compute capability 3.0 or higher.

```
executionEnvironment = "auto";
```

### Train Model

Train the model using a custom training loop.

For each epoch, shuffle the data and loop over mini-batches of data. At the end of each epoch, display the training progress.

For each mini-batch:

- Convert the labels to dummy variables.
- Convert the data to `darray` objects with underlying type `single` and specify the dimension labels 'SSCB' (spatial, spatial, channel, batch).
- For GPU training, convert to `gpuArray` objects.
- Evaluate the model gradients, state, and loss using `dlfeval` and the `modelGradients` function and update the network state.
- Determine the learning rate for the time-based decay learning rate schedule.
- Update the network parameters using the `sgdupdate` function.

Initialize the training progress plot.

```
if plots == "training-progress"  
    figure  
    lineLossTrain = animatedline('Color',[0.85 0.325 0.098]);  
    ylim([0 inf])  
    xlabel("Iteration")  
    ylabel("Loss")  
    grid on  
end
```

Initialize the velocity parameter for the SGDM solver.

```
velocity = [];
```

Train the network.

```
numObservations = numel(YTrain);  
numIterationsPerEpoch = floor(numObservations./miniBatchSize);
```

```
iteration = 0;  
start = tic;
```

```
% Loop over epochs.  
for epoch = 1:numEpochs
```

```

% Shuffle data.
idx = randperm(numel(YTrain));
XTrain = XTrain(:,:,idx);
YTrain = YTrain(idx);

% Loop over mini-batches.
for i = 1:numIterationsPerEpoch
    iteration = iteration + 1;

    % Read mini-batch of data and convert the labels to dummy
    % variables.
    idx = (i-1)*miniBatchSize+1:i*miniBatchSize;
    X = XTrain(:,:,idx);

    Y = zeros(numClasses, miniBatchSize, 'single');
    for c = 1:numClasses
        Y(c,YTrain(idx)==classes(c)) = 1;
    end

    % Convert mini-batch of data to dlarray.
    dlX = dlarray(single(X), 'SSCB');

    % If training on a GPU, then convert data to gpuArray.
    if (executionEnvironment == "auto" && canUseGPU) || executionEnvironment == "gpu"
        dlX = gpuArray(dlX);
    end

    % Evaluate the model gradients, state, and loss using dlfeval and the
    % modelGradients function and update the network state.
    [gradients,state,loss] = dlfeval(@modelGradients,dlnet,dlX,Y);
    dlnet.State = state;

    % Determine learning rate for time-based decay learning rate schedule.
    learnRate = initialLearnRate/(1 + decay*iteration);

    % Update the network parameters using the SGDM optimizer.
    [dlnet, velocity] = sgdmupdate(dlnet, gradients, velocity, learnRate, momentum);

    % Display the training progress.
    if plots == "training-progress"
        D = duration(0,0,toc(start), 'Format', 'hh:mm:ss');
        addpoints(lineLossTrain,iteration,double(gather(extractdata(loss))))
        title("Epoch: " + epoch + ", Elapsed: " + string(D))
        drawnow
    end
end
end
end

```

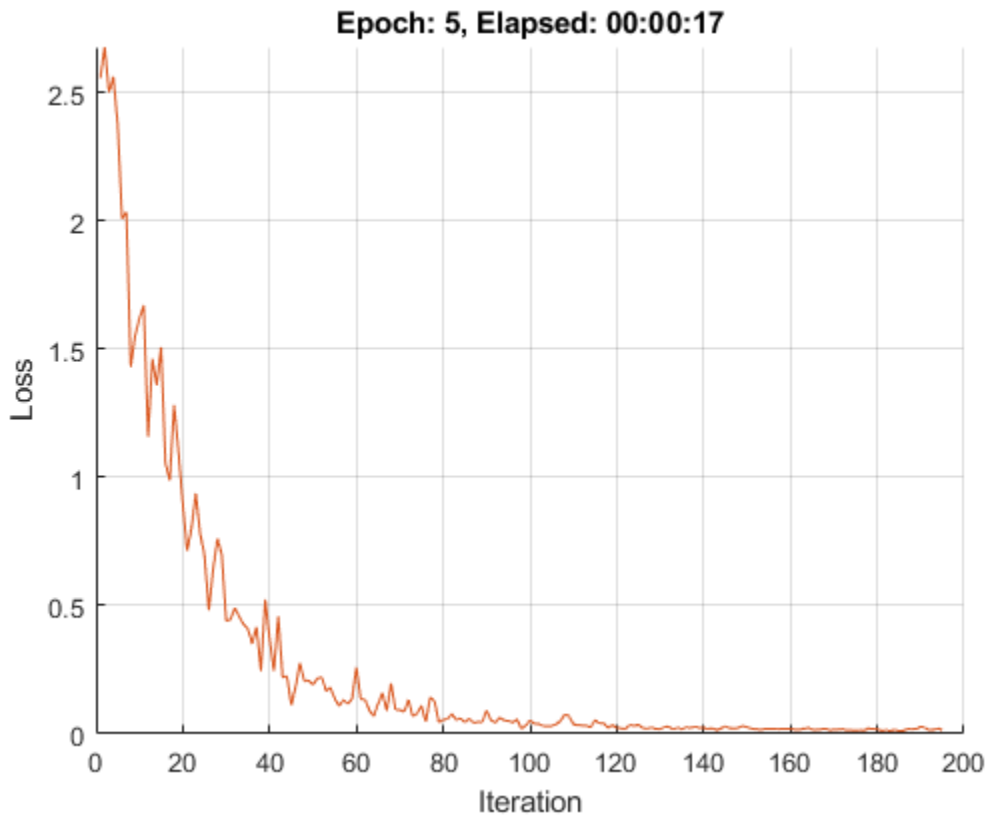

### Test Model

Test the classification accuracy of the model by comparing the predictions on a test set with the true labels.

```
[XTest, YTest] = digitTest4DArrayData;
```

Convert the data to a `darray` object with dimension format 'SSCB'. For GPU prediction, also convert the data to `gpuArray`.

```
dLXTest = darray(XTest, 'SSCB');
if (executionEnvironment == "auto" && canUseGPU) || executionEnvironment == "gpu"
    dLXTest = gpuArray(dLXTest);
end
```

Classify the images using `modelPredictions` function, listed at the end of the example and find the classes with the highest scores.

```
dLYPred = modelPredictions(dlnet, dLXTest, miniBatchSize);
[~, idx] = max(extractdata(dLYPred), [], 1);
YPred = classes(idx);
```

Evaluate the classification accuracy.

```
accuracy = mean(YPred == YTest)
```

```
accuracy = 0.9910
```

## Model Gradients Function

The `modelGradients` function takes a `dlnetwork` object `dlnet`, a mini-batch of input data `dLX` with corresponding labels `Y` and returns the gradients of the loss with respect to the learnable parameters in `dlnet`, the network state, and the loss. To compute the gradients automatically, use the `dlgradient` function.

```
function [gradients,state,loss] = modelGradients(dlnet,dLX,Y)

[dLYPred,state] = forward(dlnet,dLX);

loss = crossentropy(dLYPred,Y);
gradients = dlgradient(loss,dlnet.Learnables);

end
```

## Model Predictions Function

The `modelPredictions` function takes a `dlnetwork` object `dlnet`, an array of input data `dLX`, and a mini-batch size, and outputs the model predictions by iterating over mini-batches of the specified size.

```
function dLYPred = modelPredictions(dlnet,dLX,miniBatchSize)

numObservations = size(dLX,4);
numIterations = ceil(numObservations / miniBatchSize);

numClasses = dlnet.Layers(11).OutputSize;
dLYPred = zeros(numClasses,numObservations,'like',dLX);

for i = 1:numIterations
    idx = (i-1)*miniBatchSize+1:min(i*miniBatchSize,numObservations);

    dLYPred(:,idx) = predict(dlnet,dLX(:,:,,idx));
end

end
```

## Input Arguments

### **dlnet** — Network for custom training loops

`dlnetwork` object

Network for custom training loops, specified as a `dlnetwork` object.

### **dLX** — Input data

formatted `dlarray`

Input data, specified as a formatted `dlarray`. For more information about `dlarray` formats, see the `fmt` input argument of `dlarray`.

### **layerNames** — Layers to extract outputs from

string array | cell array of character vectors

Layers to extract outputs from, specified as a string array or a cell array of character vectors containing the layer names.

- If `layerNames(i)` corresponds to a layer with a single output, then `layerNames(i)` is the name of the layer.
- If `layerNames(i)` corresponds to a layer with multiple outputs, then `layerNames(i)` is the layer name followed by the character "/" and the name of the layer output: 'layerName/outputName'.

## Output Arguments

### **dY** — Output data

formatted `dLarray`

Output data, returned as a formatted `dLarray`. For more information about `dLarray` formats, see the `fmt` input argument of `dLarray`.

### **state** — Updated network state

table

Updated network state, returned as a table.

The network state is a table with three columns:

- `Layer` - Layer name, specified as a string scalar.
- `Parameter` - Parameter name, specified as a string scalar.
- `Value` - Value of parameter, specified as a numeric array object.

The network state contains information remembered by the network between iterations. For example, the state of LSTM and batch normalization layers.

Update the state of a `dLnetwork` using the `State` property.

## Extended Capabilities

### **GPU Arrays**

Accelerate code by running on a graphics processing unit (GPU) using Parallel Computing Toolbox™.

Usage notes and limitations:

- This function runs on the GPU if either or both of the following conditions are met:
  - Any of the values of the network learnable parameters inside `dLnet.Learnables.Value` are `dLarray` objects with underlying data of type `gpuArray`
  - The input argument `dLX` is a `dLarray` with underlying data of type `gpuArray`

For more information, see “Run MATLAB Functions on a GPU” (Parallel Computing Toolbox).

## See Also

`dLarray` | `dLfeval` | `dLgradient` | `dLnetwork` | `predict`

### **Topics**

“Train Generative Adversarial Network (GAN)”

“Automatic Differentiation Background”

“Define Custom Training Loops, Loss Functions, and Networks”

**Introduced in R2019b**

## fullyconnect

Sum all weighted input data and apply a bias

### Syntax

```
dLY = fullyconnect(dlX,weights,bias)
dLY = fullyconnect(dlX,weights,bias,'DataFormat',FMT)
```

### Description

The fully connect operation multiplies the input by a weight matrix and then adds a bias vector.

---

**Note** This function applies the fully connect operation to `dLarray` data. If you want to apply average pooling within a `layerGraph` object or `Layer` array, use the following layer:

- `fullyConnectedLayer`
- 

`dLY = fullyconnect(dlX,weights,bias)` computes the weighted sum of the spatial, channel, and unspecified data in `dlX` using the weights specified by `weights`, and adds a bias. The input `dlX` is a formatted `dLarray` with dimension labels. The output `dLY` is a formatted `dLarray`.

`dLY = fullyconnect(dlX,weights,bias,'DataFormat',FMT)` also specifies the dimension format `FMT` when `dlX` is not a formatted `dLarray`. The output `dLY` is an unformatted `dLarray`.

### Examples

#### Fully Connect All Input Data to Output Features

The `fullyconnect` function uses the weighted sum to connect all inputs of an observation to each output feature.

Create the input data as a single observation of random values with a height and width of 12 and 32 channels.

```
height = 12;
width = 12;
channels = 32;
observations = 1;
```

```
X = rand(height,width,channels,observations);
dlX = dLarray(X,'SSCB');
```

Create the learnable parameters. For this operation there are ten output features.

```
outputFeatures = 10;
```

```
weights = ones(outputFeatures,height,width,channels);
bias = ones(outputFeatures,1);
```



Apply the fullyconnect operation.

```
dLY = fullyconnect(dlX,weights,bias);
```

```
dLY =
  10(C) × 1(B) dLarray
  1.0e+03 *
  2.3266
  2.3266
  2.3266
  2.3266
  2.3266
  2.3266
  2.3266
  2.3266
  2.3266
  2.3266
```

The output dLY is a 2-D dLarray with one channel dimension of size ten and one singleton batch dimension.

## Input Arguments

### dLX — Input data

dLarray | numeric array

Input data, specified as a dLarray with or without dimension labels or a numeric array. When dLX is not a formatted dLarray, you must specify the dimension label format using 'DataFormat', FMT. If dLX is a numeric array, at least one of weights or bias must be a dLarray.

The fullyconnect operation sums over the 'S', 'C', and 'U' dimensions of dLX for each output feature specified by weights. The size of each 'B' or 'T' dimension of dLX is preserved.

Data Types: single | double

### weights — Weights

dLarray | numeric array

Weights, specified as a dLarray with or without labels or a numeric array.

If weights is an unformatted dLarray or a numeric array, the first dimension of weights must match the number of output features. If weights is a formatted dLarray, the size of the 'C' dimension must match the number of output features. weights must contain the same number of elements as the combined size of the 'S', 'C', and 'U' dimensions of input dLX multiplied by the number of output features.

Data Types: single | double

### bias — Bias constant

dLarray vector | numeric vector

Bias constant, specified as a dLarray vector with or without labels or a numeric vector.

Each element of `bias` is the bias applied to the corresponding feature output. The number of elements of `bias` must match the number of output features specified by the first dimension of `weights`.

If `bias` is a formatted `darray`, the nonsingleton dimension must be a channel dimension labeled 'C'.

Data Types: `single` | `double`

### **FMT — Dimension order of unformatted data**

`char array` | `string`

Dimension order of unformatted input data, specified as the comma-separated pair consisting of 'DataFormat' and a character array or string FMT that provides a label for each dimension of the data. Each character in FMT must be one of the following:

- 'S' — Spatial
- 'C' — Channel
- 'B' — Batch (for example, samples and observations)
- 'T' — Time (for example, sequences)
- 'U' — Unspecified

You can specify multiple dimensions labeled 'S' or 'U'. You can use the labels 'C', 'B', and 'T' at most once.

You must specify 'DataFormat', FMT when the input data `dX` is not a formatted `darray`.

Example: 'DataFormat', 'SSCB'

Data Types: `char` | `string`

## **Output Arguments**

### **dY — Weighted output features**

`darray`

Weighted output features, returned as a `darray`. The output `dY` has the same underlying data type as the input `dX`.

If the input `dX` is a formatted `darray`, the output `dY` has one dimension labeled 'C' representing the output features, and the same number of 'B' or 'T' dimensions as the input `dX`, if either or both are present. If `dX` has no 'B' or 'T' dimensions, `dY` has the format 'CB', where the 'B' dimension is singleton.

If the input `dX` is not a formatted `darray`, output `dY` is unformatted. The first dimension of `dY` contains the output features. Other dimensions of `dY` correspond to the 'B' and 'T' dimensions of `dX`, if either or both are present, and are provided in the same order as in FMT. If `dX` has no 'B' or 'T' dimensions, the first dimension of `dY` contains the output features and the second dimension is singleton.

## More About

### Fully Connect Operation

The `fullyconnect` function connects all outputs of the previous operation to the outputs of the `fullyconnect` function. For more information, see the definition of “Fully Connected Layer” on page 1-400 on the `fullyConnectedLayer` reference page.

## Extended Capabilities

### GPU Arrays

Accelerate code by running on a graphics processing unit (GPU) using Parallel Computing Toolbox™.

Usage notes and limitations:

- When at least one of the following input arguments is a `gpuArray` or a `dlarray` with underlying data of type `gpuArray`, this function runs on the GPU:
  - `dlX`
  - `weights`
  - `bias`

For more information, see “Run MATLAB Functions on a GPU” (Parallel Computing Toolbox).

## See Also

`batchnorm` | `dlarray` | `dlconv` | `dlfeval` | `dlgradient` | `relu` | `sigmoid` | `softmax`

### Topics

“Define Custom Training Loops, Loss Functions, and Networks”

“Train Network Using Model Function”

“Make Predictions Using Model Function”

“Train a Siamese Network to Compare Images”

“Train Network with Multiple Outputs”

### Introduced in R2019b

# fullyConnectedLayer

Fully connected layer

## Description

A fully connected layer multiplies the input by a weight matrix and then adds a bias vector.

## Creation

### Syntax

```
layer = fullyConnectedLayer(outputSize)  
layer = fullyConnectedLayer(outputSize,Name,Value)
```

### Description

`layer = fullyConnectedLayer(outputSize)` returns a fully connected layer and specifies the `OutputSize` property.

`layer = fullyConnectedLayer(outputSize,Name,Value)` sets the optional “Parameters and Initialization” on page 1-394, “Learn Rate and Regularization” on page 1-396, and `Name` properties using name-value pairs. For example, `fullyConnectedLayer(10,'Name','fc1')` creates a fully connected layer with an output size of 10 and the name 'fc1'. You can specify multiple name-value pairs. Enclose each property name in single quotes.

## Properties

### Fully Connected

#### OutputSize — Output size

positive integer

Output size for the fully connected layer, specified as a positive integer.

Example: 10

#### InputSize — Input size

'auto' (default) | positive integer

Input size for the fully connected layer, specified as a positive integer or 'auto'. If `InputSize` is 'auto', then the software automatically determines the input size during training.

### Parameters and Initialization

#### WeightsInitializer — Function to initialize weights

'glorot' (default) | 'he' | 'orthogonal' | 'narrow-normal' | 'zeros' | 'ones' | function handle

Function to initialize the weights, specified as one of the following:

- 'glorot' - Initialize the weights with the Glorot initializer [1] (also known as Xavier initializer). The Glorot initializer independently samples from a uniform distribution with zero mean and variance  $2/(\text{InputSize} + \text{OutputSize})$ .
- 'he' - Initialize the weights with the He initializer [2]. The He initializer samples from a normal distribution with zero mean and variance  $2/\text{InputSize}$ .
- 'orthogonal' - Initialize the input weights with  $Q$ , the orthogonal matrix given by the QR decomposition of  $Z = QR$  for a random matrix  $Z$  sampled from a unit normal distribution. [3]
- 'narrow-normal' - Initialize the weights by independently sampling from a normal distribution with zero mean and standard deviation 0.01.
- 'zeros' - Initialize the weights with zeros.
- 'ones' - Initialize the weights with ones.
- Function handle - Initialize the weights with a custom function. If you specify a function handle, then the function must be of the form `weights = func(sz)`, where `sz` is the size of the weights. For an example, see “Specify Custom Weight Initialization Function”.

The layer only initializes the weights when the `Weights` property is empty.

Data Types: `char` | `string` | `function_handle`

### **BiasInitializer – Function to initialize bias**

'zeros' (default) | 'narrow-normal' | 'ones' | function handle

Function to initialize the bias, specified as one of the following:

- 'zeros' - Initialize the bias with zeros.
- 'ones' - Initialize the bias with ones.
- 'narrow-normal' - Initialize the bias by independently sampling from a normal distribution with zero mean and standard deviation 0.01.
- Function handle - Initialize the bias with a custom function. If you specify a function handle, then the function must be of the form `bias = func(sz)`, where `sz` is the size of the bias.

The layer only initializes the bias when the `Bias` property is empty.

Data Types: `char` | `string` | `function_handle`

### **Weights – Layer weights**

[] (default) | matrix

Layer weights, specified as a matrix.

The layer weights are learnable parameters. You can specify the initial value for the weights directly using the `Weights` property of the layer. When training a network, if the `Weights` property of the layer is nonempty, then `trainNetwork` uses the `Weights` property as the initial value. If the `Weights` property is empty, then `trainNetwork` uses the initializer specified by the `WeightsInitializer` property of the layer.

At training time, `Weights` is an `OutputSize`-by-`InputSize` matrix.

Data Types: `single` | `double`

### **Bias – Layer biases**

[] (default) | matrix

Layer biases, specified as a matrix.

The layer biases are learnable parameters. When training a network, if `Bias` is nonempty, then `trainNetwork` uses the `Bias` property as the initial value. If `Bias` is empty, then `trainNetwork` uses the initializer specified by `BiasInitializer`.

At training time, `Bias` is an `OutputSize-by-1` matrix.

Data Types: `single` | `double`

### **Learn Rate and Regularization**

#### **WeightLearnRateFactor — Learning rate factor for weights**

1 (default) | nonnegative scalar

Learning rate factor for the weights, specified as a nonnegative scalar.

The software multiplies this factor by the global learning rate to determine the learning rate for the weights in this layer. For example, if `WeightLearnRateFactor` is 2, then the learning rate for the weights in this layer is twice the current global learning rate. The software determines the global learning rate based on the settings specified with the `trainingOptions` function.

Example: 2

#### **BiasLearnRateFactor — Learning rate factor for biases**

1 (default) | nonnegative scalar

Learning rate factor for the biases, specified as a nonnegative scalar.

The software multiplies this factor by the global learning rate to determine the learning rate for the biases in this layer. For example, if `BiasLearnRateFactor` is 2, then the learning rate for the biases in the layer is twice the current global learning rate. The software determines the global learning rate based on the settings specified with the `trainingOptions` function.

Example: 2

#### **WeightL2Factor — L2 regularization factor for weights**

1 (default) | nonnegative scalar

L2 regularization factor for the weights, specified as a nonnegative scalar.

The software multiplies this factor by the global L2 regularization factor to determine the L2 regularization for the weights in this layer. For example, if `WeightL2Factor` is 2, then the L2 regularization for the weights in this layer is twice the global L2 regularization factor. You can specify the global L2 regularization factor using the `trainingOptions` function.

Example: 2

#### **BiasL2Factor — L2 regularization factor for biases**

0 (default) | nonnegative scalar

L2 regularization factor for the biases, specified as a nonnegative scalar.

The software multiplies this factor by the global L2 regularization factor to determine the L2 regularization for the biases in this layer. For example, if `BiasL2Factor` is 2, then the L2 regularization for the biases in this layer is twice the global L2 regularization factor. You can specify the global L2 regularization factor using the `trainingOptions` function.

Example: 2

## Layer

### Name — Layer name

' ' (default) | character vector | string scalar

Layer name, specified as a character vector or a string scalar. To include a layer in a layer graph, you must specify a nonempty unique layer name. If you train a series network with the layer and Name is set to ' ', then the software automatically assigns a name to the layer at training time.

Data Types: char | string

### NumInputs — Number of inputs

1 (default)

Number of inputs of the layer. This layer accepts a single input only.

Data Types: double

### InputNames — Input names

{ 'in' } (default)

Input names of the layer. This layer accepts a single input only.

Data Types: cell

### NumOutputs — Number of outputs

1 (default)

Number of outputs of the layer. This layer has a single output only.

Data Types: double

### OutputNames — Output names

{ 'out' } (default)

Output names of the layer. This layer has a single output only.

Data Types: cell

## Examples

### Create Fully Connected Layer

Create a fully connected layer with an output size of 10 and the name 'fc1'.

```
layer = fullyConnectedLayer(10, 'Name', 'fc1')
```

```
layer =  
    FullyConnectedLayer with properties:
```

```
        Name: 'fc1'
```

```
Hyperparameters
```

```
    InputSize: 'auto'
```

```
    OutputSize: 10
```

```
Learnable Parameters
  Weights: []
  Bias: []
```

```
Show all properties
```

Include a fully connected layer in a Layer array.

```
layers = [ ...
  imageInputLayer([28 28 1])
  convolution2dLayer(5,20)
  reluLayer
  maxPooling2dLayer(2, 'Stride',2)
  fullyConnectedLayer(10)
  softmaxLayer
  classificationLayer]
```

```
layers =
  7x1 Layer array with layers:
```

1	''	Image Input	28x28x1 images with 'zerocenter' normalization
2	''	Convolution	20 5x5 convolutions with stride [1 1] and padding [0 0 0 0]
3	''	ReLU	ReLU
4	''	Max Pooling	2x2 max pooling with stride [2 2] and padding [0 0 0 0]
5	''	Fully Connected	10 fully connected layer
6	''	Softmax	softmax
7	''	Classification Output	crossentropyex

### Specify Initial Weights and Biases in Fully Connected Layer

To specify the weights and bias initializer functions, use the `WeightsInitializer` and `BiasInitializer` properties respectively. To specify the weights and biases directly, use the `Weights` and `Bias` properties respectively.

### Specify Initialization Function

Create a fully connected layer with an output size of 10 and specify the weights initializer to be the He initializer.

```
outputSize = 10;
layer = fullyConnectedLayer(outputSize, 'WeightsInitializer', 'he')
```

```
layer =
  FullyConnectedLayer with properties:
```

```
  Name: ''
```

```
Hyperparameters
  InputSize: 'auto'
  OutputSize: 10
```

```
Learnable Parameters
  Weights: []
```



```
Bias: []
```

Show all properties

Note that the `Weights` and `Bias` properties are empty. At training time, the software initializes these properties using the specified initialization functions.

### Specify Custom Initialization Function

To specify your own initialization function for the weights and biases, set the `WeightsInitializer` and `BiasInitializer` properties to a function handle. For these properties, specify function handles that take the size of the weights and biases as input and output the initialized value.

Create a fully connected layer with output size 10 and specify initializers that sample the weights and biases from a Gaussian distribution with a standard deviation of 0.0001.

```
outputSize = 10;
weightsInitializationFcn = @(sz) rand(sz) * 0.0001;
biasInitializationFcn = @(sz) rand(sz) * 0.0001;

layer = fullyConnectedLayer(outputSize, ...
    'WeightsInitializer',@(sz) rand(sz) * 0.0001, ...
    'BiasInitializer',@(sz) rand(sz) * 0.0001)
```

```
layer =
    FullyConnectedLayer with properties:
```

```
    Name: ''
```

```
    Hyperparameters
```

```
        InputSize: 'auto'
```

```
        OutputSize: 10
```

```
    Learnable Parameters
```

```
        Weights: []
```

```
        Bias: []
```

Show all properties

Again, the `Weights` and `Bias` properties are empty. At training time, the software initializes these properties using the specified initialization functions.

### Specify Weights and Bias Directly

Create a fully connected layer with an output size of 10 and set the weights and bias to `W` and `b` in the MAT file `FCWeights.mat` respectively.

```
outputSize = 10;
load FCWeights

layer = fullyConnectedLayer(outputSize, ...
    'Weights',W, ...
    'Bias',b)
```

```
layer =
    FullyConnectedLayer with properties:
```

```
Name: ''  
  
Hyperparameters  
  InputSize: 720  
  OutputSize: 10  
  
Learnable Parameters  
  Weights: [10x720 double]  
  Bias: [10x1 double]  
  
Show all properties
```

Here, the `Weights` and `Bias` properties contain the specified values. At training time, if these properties are non-empty, then the software uses the specified values as the initial weights and biases. In this case, the software does not use the initializer functions.

## More About

### Fully Connected Layer

A fully connected layer multiplies the input by a weight matrix and then adds a bias vector.

The convolutional (and down-sampling) layers are followed by one or more fully connected layers.

As the name suggests, all neurons in a fully connected layer connect to all the neurons in the previous layer. This layer combines all of the features (local information) learned by the previous layers across the image to identify the larger patterns. For classification problems, the last fully connected layer combines the features to classify the images. This is the reason that the `outputSize` argument of the last fully connected layer of the network is equal to the number of classes of the data set. For regression problems, the output size must be equal to the number of response variables.

You can also adjust the learning rate and the regularization parameters for this layer using the related name-value pair arguments when creating the fully connected layer. If you choose not to adjust them, then `trainNetwork` uses the global training parameters defined by the `trainingOptions` function. For details on global and layer training options, see “Set Up Parameters and Train Convolutional Neural Network”.

A fully connected layer multiplies the input by a weight matrix  $W$  and then adds a bias vector  $b$ .

If the input to the layer is a sequence (for example, in an LSTM network), then the fully connected layer acts independently on each time step. For example, if the layer before the fully connected layer outputs an array  $X$  of size  $D$ -by- $N$ -by- $S$ , then the fully connected layer outputs an array  $Z$  of size `outputSize`-by- $N$ -by- $S$ . At time step  $t$ , the corresponding entry of  $Z$  is  $WX_t + b$ , where  $X_t$  denotes time step  $t$  of  $X$ .

## Compatibility Considerations

### Default weights initialization is Glorot

*Behavior changed in R2019a*

Starting in R2019a, the software, by default, initializes the layer weights of this layer using the Glorot initializer. This behavior helps stabilize training and usually reduces the training time of deep networks.

In previous releases, the software, by default, initializes the layer weights by sampling from a normal distribution with zero mean and variance 0.01. To reproduce this behavior, set the 'WeightsInitializer' option of the layer to 'narrow-normal'.

## References

- [1] Glorot, Xavier, and Yoshua Bengio. "Understanding the difficulty of training deep feedforward neural networks." In *Proceedings of the thirteenth international conference on artificial intelligence and statistics*, pp. 249-256. 2010.
- [2] He, Kaiming, Xiangyu Zhang, Shaoqing Ren, and Jian Sun. "Delving deep into rectifiers: Surpassing human-level performance on imagenet classification." In *Proceedings of the IEEE international conference on computer vision*, pp. 1026-1034. 2015.
- [3] Saxe, Andrew M., James L. McClelland, and Surya Ganguli. "Exact solutions to the nonlinear dynamics of learning in deep linear neural networks." *arXiv preprint arXiv:1312.6120* (2013).

## Extended Capabilities

### GPU Code Generation

Generate CUDA® code for NVIDIA® GPUs using GPU Coder™.

## See Also

**Deep Network Designer** | `batchNormalizationLayer` | `convolution2dLayer` | `reluLayer` | `trainNetwork`

### Topics

"Create Simple Deep Learning Network for Classification"  
"Train Convolutional Neural Network for Regression"  
"Deep Learning in MATLAB"  
"Specify Layers of Convolutional Neural Network"  
"Compare Layer Weight Initializers"  
"List of Deep Learning Layers"

### Introduced in R2016a

## functionToLayerGraph

Convert deep learning model function to a layer graph

### Syntax

```
lgraph = functionToLayerGraph(fun,x)
```

### Description

`lgraph = functionToLayerGraph(fun,x)` returns a layer graph based on the deep learning array function `fun`. `functionToLayerGraph` converts only those operations in `fun` that operate on `dlarray` objects among the inputs in `x`. To include extra parameters or data in `fun`, see the topic “Parameterizing Functions” (MATLAB) or the example “Create Layer Graph from Function” on page 1-402.

`functionToLayerGraph` evaluates `fun(x)` and traces the execution to derive an equivalent layer graph, to the extent possible. The steps in `fun(x)` that `functionToLayerGraph` can trace are both based on `dlarray` arguments and are supported calls for `dlarray`. See “List of Functions with `dlarray` Support”. For unsupported functions, `functionToLayerGraph` creates a `PlaceholderLayer`.

### Examples

#### Create Layer Graph from Function

The `simplemodel` function at the end of this example creates fully connected outputs followed by a softmax operation. To create a layer graph from this function based on `dlarray` data, create input arrays as `dlarray` objects, and create a function handle to the `simplemodel` function including the data.

```
rng default % For reproducibility
dlX1 = dlarray(rand(10), 'CB');
dlX2 = dlarray(zeros(10,1), 'CB');
fun = @(x) simplemodel(x,dlX1,dlX2);
```

Call `functionToLayerGraph` using a `dlarray` for the input data `dlX`.

```
dlX = dlarray(ones(10,1), 'CB');
lgraph = functionToLayerGraph(fun,dlX)
```

```
lgraph =
  LayerGraph with properties:
    Layers: [2x1 nnet.cnn.layer.Layer]
    Connections: [1x2 table]
    InputNames: {1x0 cell}
    OutputNames: {1x0 cell}
```

Examine the resulting layers in `lgraph`.

```
disp(lgraph.Layers)
```

```
2x1 Layer array with layers:
```

```
    1  'fc_1'  Fully Connected  10 fully connected layer
    2  'sm_1'  Softmax          softmax
```

```
function y = simplemodel(x,w,b)
y = fullyconnect(x,w,b);
y = softmax(y);
end
```

## Input Arguments

### fun — Function to convert

function handle

Function to convert, specified as a function handle.

Example: @relu

Data Types: function\_handle

### x — Data for function

any data type

Data for the function, specified as any data type. Only `dlarray` data is traced and converted to a layer graph.

Example: `dlarray(zeros(12*50,23))`

Data Types: `single` | `double` | `int8` | `int16` | `int32` | `int64` | `uint8` | `uint16` | `uint32` | `uint64` | `logical` | `char` | `string` | `struct` | `table` | `cell` | `function_handle` | `categorical` | `datetime` | `duration` | `calendarDuration` | `fi`

## Output Arguments

### lgraph — Layer graph

LayerGraph object

Layer graph, returned as a LayerGraph object.

When a portion of `fun` is unsupported, `lgraph` contains `PlaceholderLayer` layers representing the unsupported functionality. To create a working network in this case, see “Define Custom Deep Learning Layers” or “Define Custom Networks”.

## See Also

`PlaceholderLayer` | `dlarray` | `findPlaceholderLayers` | `layerGraph`

## Topics

“List of Functions with `dlarray` Support”

**Introduced in R2019b**

## getL2Factor

**Package:** `nnet.cnn.layer`

Get L2 regularization factor of layer learnable parameter

### Syntax

```
factor = getL2RateFactor(layer,parameterName)
```

### Description

`factor = getL2RateFactor(layer,parameterName)` returns the L2 regularization factor of the parameter with the name `parameterName` in `layer`.

For built-in layers, you can get the L2 regularization factor directly by using the corresponding property. For example, for a `convolution2dLayer` layer, the syntax `factor = getL2Factor(layer, 'Weights', factor)` is equivalent to `factor = layer.WeightL2Factor`.

### Examples

#### Set and Get L2 Regularization Factor of Learnable Parameter

Set and get the L2 regularization factor of a learnable parameter of a layer.

Define a custom PReLU layer. To create this layer, save the file `preluLayer.m` in the current folder.

Create a layer array including a custom layer `preluLayer`.

```
layers = [ ...  
    imageInputLayer([28 28 1])  
    convolution2dLayer(5,20)  
    batchNormalizationLayer  
    preluLayer(20,'prelu')  
    fullyConnectedLayer(10)  
    softmaxLayer  
    classificationLayer];
```

Set the L2 regularization factor of the 'Alpha' learnable parameter of the `preluLayer` to 2.

```
layers(4) = setL2Factor(layers(4), 'Alpha', 2);
```

View the updated L2 regularization factor.

```
factor = getL2Factor(layers(4), 'Alpha')
```

```
factor = 2
```

## Input Arguments

### **layer** — Input layer

scalar Layer object

Input layer, specified as a scalar Layer object.

### **parameterName** — Parameter name

character vector | string scalar

Parameter name, specified as a character vector or a string scalar.

## See Also

getLearnRateFactor | setL2Factor | setLearnRateFactor | trainNetwork | trainingOptions

### Topics

“Deep Learning in MATLAB”

“Specify Layers of Convolutional Neural Network”

“Define Custom Deep Learning Layers”

### Introduced in R2017b

## getLearnRateFactor

**Package:** `nnet.cnn.layer`

Get learn rate factor of layer learnable parameter

### Syntax

```
factor = getLearnRateFactor(layer,parameterName)
```

### Description

`factor = getLearnRateFactor(layer,parameterName)` returns the learn rate factor of the parameter with the name `parameterName` in `layer`.

For built-in layers, you can get the learn rate factor directly by using the corresponding property. For example, for a `convolution2dLayer` layer, the syntax `factor = getLearnRateFactor(layer, 'Weights', factor)` is equivalent to `factor = layer.WeightLearnRateFactor`.

### Examples

#### Set and Get Learning Rate Factor of Learnable Parameter

Set and get the learning rate factor of a learnable parameter of a custom PReLU layer.

Define a custom PReLU layer. To create this layer, save the file `preluLayer.m` in the current folder.

Create a layer array including the custom layer `preluLayer`.

```
layers = [ ...  
    imageInputLayer([28 28 1])  
    convolution2dLayer(5,20)  
    batchNormalizationLayer  
    preluLayer(20, 'prelu')  
    fullyConnectedLayer(10)  
    softmaxLayer  
    classificationLayer];
```

Set the learn rate factor of the 'Alpha' learnable parameter of the `preluLayer` to 2.

```
layers(4) = setLearnRateFactor(layers(4), 'Alpha', 2);
```

View the updated learn rate factor.

```
factor = getLearnRateFactor(layers(4), 'Alpha')
```

```
factor = 2
```



## Input Arguments

### **layer** — Input layer

scalar Layer object

Input layer, specified as a scalar Layer object.

### **parameterName** — Parameter name

character vector | string scalar

Parameter name, specified as a character vector or a string scalar.

## See Also

[getL2Factor](#) | [setL2Factor](#) | [setLearnRateFactor](#) | [trainNetwork](#) | [trainingOptions](#)

## Topics

“Deep Learning in MATLAB”

“Specify Layers of Convolutional Neural Network”

“Define Custom Deep Learning Layers”

## Introduced in R2017b

# globalAveragePooling2dLayer

Global average pooling layer

## Description

A global average pooling layer performs down-sampling by computing the mean of the height and width dimensions of the input.

## Creation

### Syntax

```
layer = globalAveragePooling2dLayer  
layer = globalAveragePooling2dLayer('Name', name)
```

### Description

`layer = globalAveragePooling2dLayer` creates a global average pooling layer.

`layer = globalAveragePooling2dLayer('Name', name)` sets the optional Name property.

## Properties

### Name — Layer name

' ' (default) | character vector | string scalar

Layer name, specified as a character vector or a string scalar. To include a layer in a layer graph, you must specify a nonempty unique layer name. If you train a series network with the layer and Name is set to ' ', then the software automatically assigns a name to the layer at training time.

Data Types: `char` | `string`

### NumInputs — Number of inputs

1 (default)

Number of inputs of the layer. This layer accepts a single input only.

Data Types: `double`

### InputNames — Input names

{ 'in' } (default)

Input names of the layer. This layer accepts a single input only.

Data Types: `cell`

### NumOutputs — Number of outputs

1 (default)

Number of outputs of the layer. This layer has a single output only.

Data Types: double

### OutputNames — Output names

{ 'out' } (default)

Output names of the layer. This layer has a single output only.

Data Types: cell

## Examples

### Create Global Average Pooling Layer

Create a global average pooling layer with the name 'gap1'.

```
layer = globalAveragePooling2dLayer('Name', 'gap1')
```

```
layer =
  GlobalAveragePooling2DLayer with properties:
    Name: 'gap1'
```

Include a global average pooling layer in a Layer array.

```
layers = [ ...
  imageInputLayer([28 28 1])
  convolution2dLayer(5,20)
  reluLayer
  globalAveragePooling2dLayer
  fullyConnectedLayer(10)
  softmaxLayer
  classificationLayer]

layers =
  7x1 Layer array with layers:

   1  ''  Image Input           28x28x1 images with 'zerocenter' normalization
   2  ''  Convolution          20 5x5 convolutions with stride [1 1] and padding [0 0]
   3  ''  ReLU                  ReLU
   4  ''  Global Average Pooling Global average pooling
   5  ''  Fully Connected       10 fully connected layer
   6  ''  Softmax                softmax
   7  ''  Classification Output crossentropyex
```

## Tips

- In an image classification network, you can use a `globalAveragePooling2dLayer` before the final fully connected layer to reduce the size of the activations without sacrificing performance. The reduced size of the activations means that the downstream fully connected layers will have fewer weights, reducing the size of your network.
- You can use a `globalAveragePooling2dLayer` towards the end of a classification network instead of a `fullyConnectedLayer`. Since global pooling layers have no learnable parameters, they can be less prone to overfitting and can reduce the size of the network. These networks can

also be more robust to spatial translations of input data. You can also replace a fully connected layer with a `globalMaxPooling2dLayer` instead. Whether a `globalMaxPooling2dLayer` or a `globalAveragePooling2dLayer` is more appropriate depends on your data set.

To use a global average pooling layer instead of a fully connected layer, the size of the input to `globalAveragePooling2dLayer` must match the number of classes in the classification problem

## Extended Capabilities

### GPU Code Generation

Generate CUDA® code for NVIDIA® GPUs using GPU Coder™.

### See Also

`averagePooling2dLayer` | `convolution2dLayer` | `globalAveragePooling3dLayer` | `globalMaxPooling2dLayer` | `maxPooling2dLayer`

### Topics

“Create Simple Deep Learning Network for Classification”

“Train Convolutional Neural Network for Regression”

“Deep Learning in MATLAB”

“Specify Layers of Convolutional Neural Network”

“List of Deep Learning Layers”

### Introduced in R2019b

# globalAveragePooling3dLayer

3-D global average pooling layer

## Description

A 3-D global average pooling layer performs down-sampling by computing the mean of the height, width, and depth dimensions of the input.

## Creation

### Syntax

```
layer = globalAveragePooling3dLayer  
layer = globalAveragePooling3dLayer('Name', name)
```

### Description

`layer = globalAveragePooling3dLayer` creates a 3-D global average pooling layer.

`layer = globalAveragePooling3dLayer('Name', name)` sets the optional Name property.

## Properties

### Name — Layer name

' ' (default) | character vector | string scalar

Layer name, specified as a character vector or a string scalar. To include a layer in a layer graph, you must specify a nonempty unique layer name. If you train a series network with the layer and Name is set to ' ', then the software automatically assigns a name to the layer at training time.

Data Types: `char` | `string`

### NumInputs — Number of inputs

1 (default)

Number of inputs of the layer. This layer accepts a single input only.

Data Types: `double`

### InputNames — Input names

{'in'} (default)

Input names of the layer. This layer accepts a single input only.

Data Types: `cell`

### NumOutputs — Number of outputs

1 (default)

Number of outputs of the layer. This layer has a single output only.

Data Types: double

### OutputNames — Output names

{'out'} (default)

Output names of the layer. This layer has a single output only.

Data Types: cell

## Examples

### Create 3-D Global Average Pooling Layer

Create a 3-D global average pooling layer with the name 'gap1'.

```
layer = globalAveragePooling3dLayer('Name','gap1')
```

```
layer =  
GlobalAveragePooling3dLayer with properties:  
  
Name: 'gap1'
```

Include a 3-D global average pooling layer in a Layer array.

```
layers = [ ...  
    image3dInputLayer([28 28 28 3])  
    convolution3dLayer(5,20)  
    reluLayer  
    globalAveragePooling3dLayer  
    fullyConnectedLayer(10)  
    softmaxLayer  
    classificationLayer]  
  
layers =  
7x1 Layer array with layers:  
  
1 '' 3-D Image Input 28x28x28x3 images with 'zerocenter' normalization  
2 '' Convolution 20 5x5x5 convolutions with stride [1 1 1] and padding  
3 '' ReLU ReLU  
4 '' 3-D Global Average Pooling 3-D global average pooling  
5 '' Fully Connected 10 fully connected layer  
6 '' Softmax softmax  
7 '' Classification Output crossentropy
```

## Tips

- In an image classification network, you can use a `globalAveragePooling3dLayer` before the final fully connected layer to reduce the size of the activations without sacrificing performance. The reduced size of the activations means that the downstream fully connected layers will have fewer weights, reducing the size of your network.
- You can use a `globalAveragePooling3dLayer` towards the end of a classification network instead of a `fullyConnectedLayer`. Since global pooling layers have no learnable parameters, they can be less prone to overfitting and can reduce the size of the network. These networks can

also be more robust to spatial translations of input data. You can also replace a fully connected layer with a `globalMaxPooling3dLayer` instead. Whether a `globalMaxPooling3dLayer` or a `globalAveragePooling3dLayer` is more appropriate depends on your data set.

To use a global average pooling layer instead of a fully connected layer, the size of the input to `globalAveragePooling3dLayer` must match the number of classes in the classification problem

## See Also

`averagePooling3dLayer` | `convolution3dLayer` | `globalAveragePooling2dLayer` | `globalMaxPooling3dLayer` | `maxPooling3dLayer`

## Topics

“Deep Learning in MATLAB”

“Specify Layers of Convolutional Neural Network”

“List of Deep Learning Layers”

**Introduced in R2019b**

# globalMaxPooling2dLayer

Global max pooling layer

## Description

A global max pooling layer performs down-sampling by computing the maximum of the height and width dimensions of the input.

## Creation

### Syntax

```
layer = globalMaxPooling2dLayer  
layer = globalMaxPooling2dLayer('Name', name)
```

### Description

`layer = globalMaxPooling2dLayer` creates a global max pooling layer.

`layer = globalMaxPooling2dLayer('Name', name)` sets the optional Name property.

## Properties

### Name — Layer name

' ' (default) | character vector | string scalar

Layer name, specified as a character vector or a string scalar. To include a layer in a layer graph, you must specify a nonempty unique layer name. If you train a series network with the layer and Name is set to ' ', then the software automatically assigns a name to the layer at training time.

Data Types: `char` | `string`

### NumInputs — Number of inputs

1 (default)

Number of inputs of the layer. This layer accepts a single input only.

Data Types: `double`

### InputNames — Input names

{'in'} (default)

Input names of the layer. This layer accepts a single input only.

Data Types: `cell`

### NumOutputs — Number of outputs

1 (default)

Number of outputs of the layer. This layer has a single output only.



Data Types: double

### OutputNames — Output names

{'out'} (default)

Output names of the layer. This layer has a single output only.

Data Types: cell

## Object Functions

### Examples

#### Create Global Max Pooling Layer

Create a global max pooling layer with the name 'gmp1'.

```
layer = globalMaxPooling2dLayer('Name','gmp1')
```

```
layer =
  GlobalMaxPooling2DLayer with properties:
```

```
    Name: 'gmp1'
```

Include a global max pooling layer in a Layer array.

```
layers = [ ...
  imageInputLayer([28 28 1])
  convolution2dLayer(5,20)
  reluLayer
  globalMaxPooling2dLayer
  fullyConnectedLayer(10)
  softmaxLayer
  classificationLayer]
```

```
layers =
  7x1 Layer array with layers:
```

1	''	Image Input	28x28x1 images with 'zerocenter' normalization
2	''	Convolution	20 5x5 convolutions with stride [1 1] and padding [0 0 0 0]
3	''	ReLU	ReLU
4	''	Global Max Pooling	Global max pooling
5	''	Fully Connected	10 fully connected layer
6	''	Softmax	softmax
7	''	Classification Output	crossentropyex

### Tips

- In an image classification network, you can use a `globalMaxPooling2dLayer` before the final fully connected layer to reduce the size of the activations without sacrificing performance. The reduced size of the activations means that the downstream fully connected layers will have fewer weights, reducing the size of your network.

- You can use a `globalMaxPooling2dLayer` towards the end of a classification network instead of a `fullyConnectedLayer`. Since global pooling layers have no learnable parameters, they can be less prone to overfitting and can reduce the size of the network. These networks can also be more robust to spatial translations of input data. You can also replace a fully connected layer with a `globalAveragePooling2dLayer` instead. Whether a `globalAveragePooling2dLayer` or a `globalMaxPooling2dLayer` is more appropriate depends on your data set.

To use a global average pooling layer instead of a fully connected layer, the size of the input to `globalMaxPooling2dLayer` must match the number of classes in the classification problem

## Extended Capabilities

### GPU Code Generation

Generate CUDA® code for NVIDIA® GPUs using GPU Coder™.

### See Also

[averagePooling2dLayer](#) | [convolution2dLayer](#) | [globalAveragePooling2dLayer](#) | [globalMaxPooling3dLayer](#) | [maxPooling2dLayer](#)

### Topics

[“Create Simple Deep Learning Network for Classification”](#)  
[“Train Convolutional Neural Network for Regression”](#)  
[“Deep Learning in MATLAB”](#)  
[“Specify Layers of Convolutional Neural Network”](#)  
[“List of Deep Learning Layers”](#)

### Introduced in R2020a

# globalMaxPooling3dLayer

3-D global max pooling layer

## Description

A 3-D global max pooling layer performs down-sampling by computing the maximum of the height, width, and depth dimensions of the input.

## Creation

### Syntax

```
layer = globalMaxPooling3dLayer  
layer = globalMaxPooling3dLayer('Name', name)
```

### Description

`layer = globalMaxPooling3dLayer` creates a 3-D global max pooling layer.

`layer = globalMaxPooling3dLayer('Name', name)` sets the optional Name property.

## Properties

### Name — Layer name

' ' (default) | character vector | string scalar

Layer name, specified as a character vector or a string scalar. To include a layer in a layer graph, you must specify a nonempty unique layer name. If you train a series network with the layer and Name is set to ' ', then the software automatically assigns a name to the layer at training time.

Data Types: `char` | `string`

### NumInputs — Number of inputs

1 (default)

Number of inputs of the layer. This layer accepts a single input only.

Data Types: `double`

### InputNames — Input names

{'in'} (default)

Input names of the layer. This layer accepts a single input only.

Data Types: `cell`

### NumOutputs — Number of outputs

1 (default)

Number of outputs of the layer. This layer has a single output only.

Data Types: double

### OutputNames — Output names

{'out'} (default)

Output names of the layer. This layer has a single output only.

Data Types: cell

## Object Functions

### Examples

#### Create 3-D Global Max Pooling Layer

Create a 3-D global max pooling layer with name 'gmp1'.

```
layer = globalMaxPooling3dLayer('Name','gmp1')
```

```
layer =  
GlobalMaxPooling3DLayer with properties:
```

```
    Name: 'gmp1'
```

Include a 3-D max pooling layer in a Layer array.

```
layers = [ ...  
    image3dInputLayer([28 28 28 3])  
    convolution3dLayer(5,20)  
    reluLayer  
    globalMaxPooling3dLayer  
    fullyConnectedLayer(10)  
    softmaxLayer  
    classificationLayer]
```

```
layers =  
7x1 Layer array with layers:
```

1	''	3-D Image Input	28×28×28×3 images with 'zerocenter' normalization
2	''	Convolution	20 5×5×5 convolutions with stride [1 1 1] and padding [0 0 0]
3	''	ReLU	ReLU
4	''	3-D Global Max Pooling	3-D global max pooling
5	''	Fully Connected	10 fully connected layer
6	''	Softmax	softmax
7	''	Classification Output	crossentropyex

### Tips

- In an image classification network, you can use a `globalMaxPooling3dLayer` before the final fully connected layer to reduce the size of the activations without sacrificing performance. The reduced size of the activations means that the downstream fully connected layers will have fewer weights, reducing the size of your network.

- You can use a `globalMaxPooling3dLayer` towards the end of a classification network instead of a `fullyConnectedLayer`. Since global pooling layers have no learnable parameters, they can be less prone to overfitting and can reduce the size of the network. These networks can also be more robust to spatial translations of input data. You can also replace a fully connected layer with a `globalAveragePooling3dLayer` instead. Whether a `globalAveragePooling3dLayer` or a `globalMaxPooling3dLayer` is more appropriate depends on your data set.

To use a global average pooling layer instead of a fully connected layer, the size of the input to `globalMaxPooling3dLayer` must match the number of classes in the classification problem

## See Also

`averagePooling3dLayer` | `convolution3dLayer` | `globalAveragePooling3dLayer` | `globalMaxPooling2dLayer` | `maxPooling3dLayer`

## Topics

“Deep Learning in MATLAB”

“Specify Layers of Convolutional Neural Network”

“List of Deep Learning Layers”

**Introduced in R2020a**

## googlenet

GoogLeNet convolutional neural network

### Syntax

```
net = googlenet
net = googlenet('Weights',weights)

lgraph = googlenet('Weights','none')
```

### Description

GoogLeNet is a convolutional neural network that is 22 layers deep. You can load a pretrained version of the network trained on either the ImageNet [1] or Places365 [2] [3] data sets. The network trained on ImageNet classifies images into 1000 object categories, such as keyboard, mouse, pencil, and many animals. The network trained on Places365 is similar to the network trained on ImageNet, but classifies images into 365 different place categories, such as field, park, runway, and lobby. These networks have learned different feature representations for a wide range of images. The pretrained networks both have an image input size of 224-by-224. For more pretrained networks in MATLAB, see “Pretrained Deep Neural Networks”.

To classify new images using GoogLeNet, use `classify`. For an example, see “Classify Image Using GoogLeNet”.

You can retrain a GoogLeNet network to perform a new task using transfer learning. When performing transfer learning, the most common approach is to use networks pretrained on the ImageNet data set. If the new task is similar to classifying scenes, then using the network trained on Places-365 can give higher accuracies. For an example showing how to retrain GoogLeNet on a new classification task, see “Train Deep Learning Network to Classify New Images”

`net = googlenet` returns a GoogLeNet network trained on the ImageNet data set.

This function requires the Deep Learning Toolbox Model *for GoogLeNet Network* support package. If this support package is not installed, then the function provides a download link.

`net = googlenet('Weights',weights)` returns a GoogLeNet network trained on either the ImageNet or Places365 data set. The syntax `googlenet('Weights','imagenet')` (default) is equivalent to `googlenet`.

The network trained on ImageNet requires the Deep Learning Toolbox Model *for GoogLeNet Network* support package. The network trained on Places365 requires the Deep Learning Toolbox Model *for Places365-GoogLeNet Network* support package. If the required support package is not installed, then the function provides a download link.

`lgraph = googlenet('Weights','none')` returns the untrained GoogLeNet network architecture. The untrained model does not require the support package.

### Examples

## Download GoogLeNet Support Package

Download and install the Deep Learning Toolbox Model *for GoogLeNet Network* support package.

Type `googlenet` at the command line.

```
googlenet
```

If the Deep Learning Toolbox Model *for GoogLeNet Network* support package is not installed, then the function provides a link to the required support package in the Add-On Explorer. To install the support package, click the link, and then click **Install**. Check that the installation is successful by typing `googlenet` at the command line. If the required support package is installed, then the function returns a `DAGNetwork` object.

```
googlenet
```

```
ans =
```

```
DAGNetwork with properties:
    Layers: [144x1 nnet.cnn.layer.Layer]
    Connections: [170x2 table]
```

## Input Arguments

### **weights** — Source of network parameters

```
'imagenet' (default) | 'places365' | 'none'
```

Source of network parameters, specified as `'imagenet'`, `'places365'`, or `'none'`.

- If `weights` equals `'imagenet'`, then the network has weights trained on the ImageNet data set.
- If `weights` equals `'places365'`, then the network has weights trained on the Places365 data set.
- If `weights` equals `'none'`, then the untrained network architecture is returned.

Example: `'places365'`

## Output Arguments

### **net** — Pretrained GoogLeNet convolutional neural network

```
DAGNetwork object
```

Pretrained GoogLeNet convolutional neural network, returned as a `DAGNetwork` object.

### **lgraph** — Untrained GoogLeNet convolutional neural network architecture

```
LayerGraph object
```

Untrained GoogLeNet convolutional neural network architecture, returned as a `LayerGraph` object.

## References

[1] *ImageNet*. <http://www.image-net.org>

[2] Zhou, Bolei, Aditya Khosla, Agata Lapedriza, Antonio Torralba, and Aude Oliva. "Places: An image database for deep scene understanding." *arXiv preprint arXiv:1610.02055* (2016).

[3] *Places*. <http://places2.csail.mit.edu/>

[4] Szegedy, Christian, Wei Liu, Yangqing Jia, Pierre Sermanet, Scott Reed, Dragomir Anguelov, Dumitru Erhan, Vincent Vanhoucke, and Andrew Rabinovich. "Going deeper with convolutions." In *Proceedings of the IEEE conference on computer vision and pattern recognition*, pp. 1-9. 2015.

[5] *BVLC GoogLeNet Model*. [https://github.com/BVLC/caffe/tree/master/models/bvlc\\_googlenet](https://github.com/BVLC/caffe/tree/master/models/bvlc_googlenet)

## Extended Capabilities

### C/C++ Code Generation

Generate C and C++ code using MATLAB® Coder™.

For code generation, you can load the network by using the syntax `net = googlenet` or by passing the `googlenet` function to `coder.loadDeepLearningNetwork`. For example: `net = coder.loadDeepLearningNetwork('googlenet')`

For more information, see "Load Pretrained Networks for Code Generation" (MATLAB Coder).

The syntax `googlenet('Weights', 'none')` is not supported for code generation.

### GPU Code Generation

Generate CUDA® code for NVIDIA® GPUs using GPU Coder™.

Usage notes and limitations:

- For code generation, you can load the network by using the syntax `net = googlenet` or by passing the `googlenet` function to `coder.loadDeepLearningNetwork`. For example: `net = coder.loadDeepLearningNetwork('googlenet')`.

For more information, see "Load Pretrained Networks for Code Generation" (GPU Coder).

- The syntax `googlenet('Weights', 'none')` is not supported for GPU code generation.

## See Also

[DAGNetwork](#) | [alexnet](#) | [densenet201](#) | [inceptionresnetv2](#) | [inceptionv3](#) | [layerGraph](#) | [plot](#) | [resnet101](#) | [resnet18](#) | [resnet50](#) | [squeezeNet](#) | [trainNetwork](#) | [vgg16](#) | [vgg19](#)

### Topics

"Classify Image Using GoogLeNet"

"Train Deep Learning Network to Classify New Images"

"Deep Learning in MATLAB"

"Pretrained Deep Neural Networks"

"Train Residual Network for Image Classification"

### Introduced in R2017b



# groupedConvolution2dLayer

2-D grouped convolutional layer

## Description

A 2-D grouped convolutional layer separates the input channels into groups and applies sliding convolutional filters. Use grouped convolutional layers for channel-wise separable (also known as depth-wise separable) convolution.

For each group, the layer convolves the input by moving the filters along the input vertically and horizontally and computing the dot product of the weights and the input, and then adding a bias term. The layer combines the convolutions for each group independently. If the number of groups is equal to the number of channels, then this layer performs channel-wise convolution.

## Creation

### Syntax

```
layer = groupedConvolution2dLayer(filterSize,numFiltersPerGroup,numGroups)
layer = groupedConvolution2dLayer(filterSize,numFiltersPerGroup,'channel-
wise')
layer = groupedConvolution2dLayer( ____,Name,Value)
```

### Description

`layer = groupedConvolution2dLayer(filterSize,numFiltersPerGroup,numGroups)` creates a 2-D grouped convolutional layer and sets the `FilterSize`, `NumFiltersPerGroup`, and `NumGroups` properties.

`layer = groupedConvolution2dLayer(filterSize,numFiltersPerGroup,'channel-wise')` creates a layer for channel-wise convolution (also known as depth-wise convolution). In this case, the software determines the `NumGroups` property at training time. This syntax is equivalent to setting `NumGroups` to the number of input channels.

`layer = groupedConvolution2dLayer( ____,Name,Value)` sets the optional `Stride`, `DilationFactor`, “Parameters and Initialization” on page 1-426, “Learn Rate and Regularization” on page 1-427, and `Name` properties using name-value pairs. To specify input padding, use the `'Padding'` name-value pair argument. For example, `groupedConvolution2dLayer(5,128,2,'Padding','same')` creates a 2-D grouped convolutional layer with 2 groups of 128 filters of size [5 5] and pads the input to so that the output has the same size. You can specify multiple name-value pairs. Enclose each property name in single quotes.

### Input Arguments

#### Name-Value Pair Arguments

Use comma-separated name-value pair arguments to specify the size of the zero padding to add along the edges of the layer input or to set the `Stride`, `DilationFactor`, “Parameters and Initialization”

on page 1-426, “Learn Rate and Regularization” on page 1-427, and Name properties. Enclose names in single quotes.

Example: `groupedConvolution2dLayer(5,128,2,'Padding','same')` creates a 2-D grouped convolutional layer with 2 groups of 128 filters of size [5 5] and pads the input to so that the output has the same size.

### **Padding — Input edge padding**

[0 0 0 0] (default) | vector of nonnegative integers | 'same'

Input edge padding, specified as the comma-separated pair consisting of 'Padding' and one of these values:

- 'same' — Add padding of size calculated by the software at training or prediction time so that the output has the same size as the input when the stride equals 1. If the stride is larger than 1, then the output size is `ceil(inputSize/stride)`, where `inputSize` is the height or width of the input and `stride` is the stride in the corresponding dimension. The software adds the same amount of padding to the top and bottom, and to the left and right, if possible. If the padding that must be added vertically has an odd value, then the software adds extra padding to the bottom. If the padding that must be added horizontally has an odd value, then the software adds extra padding to the right.
- Nonnegative integer `p` — Add padding of size `p` to all the edges of the input.
- Vector [a b] of nonnegative integers — Add padding of size `a` to the top and bottom of the input and padding of size `b` to the left and right.
- Vector [t b l r] of nonnegative integers — Add padding of size `t` to the top, `b` to the bottom, `l` to the left, and `r` to the right of the input.

Example: 'Padding', 1 adds one row of padding to the top and bottom, and one column of padding to the left and right of the input.

Example: 'Padding', 'same' adds padding so that the output has the same size as the input (if the stride equals 1).

## **Properties**

### **Grouped Convolution**

#### **FilterSize — Height and width of filters**

vector of two positive integers

Height and width of the filters, specified as a vector [h w] of two positive integers, where `h` is the height and `w` is the width. `FilterSize` defines the size of the local regions to which the neurons connect in the input.

When creating the layer, you can specify `FilterSize` as a scalar to use the same value for the height and width.

Example: [5 5] specifies filters with a height of 5 and a width of 5.

#### **NumFiltersPerGroup — Number of filters per group**

positive integer

Number of filters per group, specified as a positive integer. This property determines the number of channels in the output of the layer. The number of output channels is  $\text{FiltersPerGroup} * \text{NumGroups}$ .

Example: 10

### **NumGroups — Number of groups**

positive integer | 'channel-wise'

Number of groups, specified as a positive integer or 'channel-wise'.

If `NumGroups` is 'channel-wise', then the software creates a layer for channel-wise convolution (also known as depth-wise convolution). In this case, the layer determines the `NumGroups` property at training time. This value is equivalent to setting `NumGroups` to the number of input channels.

The number of groups must evenly divide the number of channels of the layer input.

Example: 2

### **Stride — Step size for traversing input**

[1 1] (default) | vector of two positive integers

Step size for traversing the input vertically and horizontally, specified as a vector [a b] of two positive integers, where a is the vertical step size and b is the horizontal step size. When creating the layer, you can specify `Stride` as a scalar to use the same value for both step sizes.

Example: [2 3] specifies a vertical step size of 2 and a horizontal step size of 3.

### **DilationFactor — Factor for dilated convolution**

[1 1] (default) | vector of two positive integers

Factor for dilated convolution (also known as atrous convolution), specified as a vector [h w] of two positive integers, where h is the vertical dilation and w is the horizontal dilation. When creating the layer, you can specify `DilationFactor` as a scalar to use the same value for both horizontal and vertical dilations.

Use dilated convolutions to increase the receptive field (the area of the input which the layer can see) of the layer without increasing the number of parameters or computation.

The layer expands the filters by inserting zeros between each filter element. The dilation factor determines the step size for sampling the input or equivalently the upsampling factor of the filter. It corresponds to an effective filter size of  $(\text{Filter Size} - 1) * \text{Dilation Factor} + 1$ . For example, a 3-by-3 filter with the dilation factor [2 2] is equivalent to a 5-by-5 filter with zeros between the elements.

Example: [2 3]

### **PaddingSize — Size of padding**

[0 0 0 0] (default) | vector of four nonnegative integers

Size of padding to apply to input borders, specified as a vector [t b l r] of four nonnegative integers, where t is the padding applied to the top, b is the padding applied to the bottom, l is the padding applied to the left, and r is the padding applied to the right.

When you create a layer, use the 'Padding' name-value pair argument to specify the padding size.

Example: [1 1 2 2] adds one row of padding to the top and bottom, and two columns of padding to the left and right of the input.

**PaddingMode — Method to determine padding size**`'manual'` (default) | `'same'`

Method to determine padding size, specified as `'manual'` or `'same'`.

The software automatically sets the value of `PaddingMode` based on the `'Padding'` value you specify when creating a layer.

- If you set the `'Padding'` option to a scalar or a vector of nonnegative integers, then the software automatically sets `PaddingMode` to `'manual'`.
- If you set the `'Padding'` option to `'same'`, then the software automatically sets `PaddingMode` to `'same'` and calculates the size of the padding at training time so that the output has the same size as the input when the stride equals 1. If the stride is larger than 1, then the output size is `ceil(inputSize/stride)`, where `inputSize` is the height or width of the input and `stride` is the stride in the corresponding dimension. The software adds the same amount of padding to the top and bottom, and to the left and right, if possible. If the padding that must be added vertically has an odd value, then the software adds extra padding to the bottom. If the padding that must be added horizontally has an odd value, then the software adds extra padding to the right.

**NumChannelsPerGroup — Number of channels per group**`'auto'` (default) | positive integer

Number of channels per group, specified as `'auto'` or a positive integer. The number of channels per group is equal to the number of input channels divided by the number of groups.

The software automatically sets this property at training time.

Example: 256

**Parameters and Initialization****WeightsInitializer — Function to initialize weights**`'glorot'` (default) | `'he'` | `'narrow-normal'` | `'zeros'` | `'ones'` | function handle

Function to initialize the weights, specified as one of the following:

- `'glorot'` - Initialize the weights with the Glorot initializer [1] (also known as Xavier initializer). The Glorot initializer independently samples from a uniform distribution with zero mean and variance  $2/(\text{numIn} + \text{numOut})$ , where `numIn` = `FilterSize(1)*FilterSize(2)*NumChannelsPerGroup` and `numOut` = `FilterSize(1)*FilterSize(2)*NumFiltersPerGroup`.
- `'he'` - Initialize the weights with the He initializer [2]. The He initializer samples from a normal distribution with zero mean and variance  $2/\text{numIn}$ , where `numIn` = `FilterSize(1)*FilterSize(2)*NumChannelsPerGroup`.
- `'narrow-normal'` - Initialize the weights by independently sampling from a normal distribution with zero mean and standard deviation 0.01.
- `'zeros'` - Initialize the weights with zeros.
- `'ones'` - Initialize the weights with ones.
- Function handle - Initialize the weights with a custom function. If you specify a function handle, then the function must be of the form `weights = func(sz)`, where `sz` is the size of the weights. For an example, see “Specify Custom Weight Initialization Function”.

The layer only initializes the weights when the `Weights` property is empty.

Data Types: char | string | function\_handle

### **BiasInitializer — Function to initialize bias**

'zeros' (default) | 'narrow-normal' | 'ones' | function handle

Function to initialize the bias, specified as one of the following:

- 'zeros' - Initialize the bias with zeros.
- 'ones' - Initialize the bias with ones.
- 'narrow-normal' - Initialize the bias by independently sampling from a normal distribution with zero mean and standard deviation 0.01.
- Function handle - Initialize the bias with a custom function. If you specify a function handle, then the function must be of the form `bias = func(sz)`, where `sz` is the size of the bias.

The layer only initializes the bias when the `Bias` property is empty.

Data Types: char | string | function\_handle

### **Weights — Layer weights**

[] (default) | numeric array

Layer weights for the layer, specified as a numeric array.

The layer weights are learnable parameters. You can specify the initial value for the weights directly using the `Weights` property of the layer. When training a network, if the `Weights` property of the layer is nonempty, then `trainNetwork` uses the `Weights` property as the initial value. If the `Weights` property is empty, then `trainNetwork` uses the initializer specified by the `WeightsInitializer` property of the layer.

At training time, `Weights` is a `FilterSize(1)-by-FilterSize(2)-by-NumChannelsPerGroup-by-NumFiltersPerGroup-by-NumGroups` array, where `NumInputChannels` is the number of channels of the layer input.

Data Types: single | double

### **Bias — Layer biases**

[] (default) | numeric array

Layer biases for the layer, specified as a numeric array.

The layer biases are learnable parameters. When training a network, if `Bias` is nonempty, then `trainNetwork` uses the `Bias` property as the initial value. If `Bias` is empty, then `trainNetwork` uses the initializer specified by `BiasInitializer`.

At training time, `Bias` is a `1-by-1-by-NumFiltersPerGroup-by-NumGroups` array.

Data Types: single | double

## **Learn Rate and Regularization**

### **WeightLearnRateFactor — Learning rate factor for weights**

1 (default) | nonnegative scalar

Learning rate factor for the weights, specified as a nonnegative scalar.

The software multiplies this factor by the global learning rate to determine the learning rate for the weights in this layer. For example, if `WeightLearnRateFactor` is 2, then the learning rate for the weights in this layer is twice the current global learning rate. The software determines the global learning rate based on the settings specified with the `trainingOptions` function.

Example: 2

**BiasLearnRateFactor — Learning rate factor for biases**

1 (default) | nonnegative scalar

Learning rate factor for the biases, specified as a nonnegative scalar.

The software multiplies this factor by the global learning rate to determine the learning rate for the biases in this layer. For example, if `BiasLearnRateFactor` is 2, then the learning rate for the biases in the layer is twice the current global learning rate. The software determines the global learning rate based on the settings specified with the `trainingOptions` function.

Example: 2

**WeightL2Factor — L2 regularization factor for weights**

1 (default) | nonnegative scalar

L2 regularization factor for the weights, specified as a nonnegative scalar.

The software multiplies this factor by the global L2 regularization factor to determine the L2 regularization for the weights in this layer. For example, if `WeightL2Factor` is 2, then the L2 regularization for the weights in this layer is twice the global L2 regularization factor. You can specify the global L2 regularization factor using the `trainingOptions` function.

Example: 2

**BiasL2Factor — L2 regularization factor for biases**

0 (default) | nonnegative scalar

L2 regularization factor for the biases, specified as a nonnegative scalar.

The software multiplies this factor by the global L2 regularization factor to determine the L2 regularization for the biases in this layer. For example, if `BiasL2Factor` is 2, then the L2 regularization for the biases in this layer is twice the global L2 regularization factor. You can specify the global L2 regularization factor using the `trainingOptions` function.

Example: 2

**Layer****Name — Layer name**

' ' (default) | character vector | string scalar

Layer name, specified as a character vector or a string scalar. To include a layer in a layer graph, you must specify a nonempty unique layer name. If you train a series network with the layer and `Name` is set to ' ', then the software automatically assigns a name to the layer at training time.

Data Types: `char` | `string`

**NumInputs — Number of inputs**

1 (default)

Number of inputs of the layer. This layer accepts a single input only.

Data Types: double

### **InputNames — Input names**

{'in'} (default)

Input names of the layer. This layer accepts a single input only.

Data Types: cell

### **NumOutputs — Number of outputs**

1 (default)

Number of outputs of the layer. This layer has a single output only.

Data Types: double

### **OutputNames — Output names**

{'out'} (default)

Output names of the layer. This layer has a single output only.

Data Types: cell

## **Examples**

### **Create Grouped Convolution Layer**

Create a grouped convolutional layer with 3 groups of 10 filters, each with a height and width of 11, and the name 'gconv1'.

```
layer = groupedConvolution2dLayer(11,10,3,'Name','gconv1')
```

```
layer =  
GroupedConvolution2DLayer with properties:
```

```
    Name: 'gconv1'
```

```
Hyperparameters
```

```
    FilterSize: [11 11]
```

```
    NumGroups: 3
```

```
    NumChannelsPerGroup: 'auto'
```

```
    NumFiltersPerGroup: 10
```

```
    Stride: [1 1]
```

```
    DilationFactor: [1 1]
```

```
    PaddingMode: 'manual'
```

```
    PaddingSize: [0 0 0 0]
```

```
Learnable Parameters
```

```
    Weights: []
```

```
    Bias: []
```

```
Show all properties
```

### Create Channel-Wise Convolution Layer

Create a channel-wise convolutional (also known as depth-wise convolutional) layer with groups of 10 filters, each with a height and width of 11, and the name 'cwconv1'.

```
layer = groupedConvolution2dLayer(11,10,'channel-wise','Name','cwconv1')
```

```
layer =  
  GroupedConvolution2DLayer with properties:
```

```
      Name: 'cwconv1'
```

```
Hyperparameters
```

```
      FilterSize: [11 11]  
      NumGroups: 'channel-wise'  
NumChannelsPerGroup: 'auto'  
NumFiltersPerGroup: 10  
      Stride: [1 1]  
      DilationFactor: [1 1]  
      PaddingMode: 'manual'  
      PaddingSize: [0 0 0 0]
```

```
Learnable Parameters
```

```
      Weights: []  
      Bias: []
```

```
Show all properties
```

### Create Layers for Channel-Wise Separable Convolution

A typical convolutional neural network contains blocks of convolution, batch normalization, and ReLU layers. For example,

```
filterSize = 3;  
numFilters = 16;
```

```
convLayers = [  
  convolution2dLayer(filterSize,numFilters,'Stride',2,'Padding','same')  
  batchNormalizationLayer  
  reluLayer];
```

For channel-wise separable convolution (also known as depth-wise separable convolution), replace the convolution block with channel-wise convolution and point-wise convolution blocks.

Specify the filter size and the stride in the channel-wise convolution and the number of filters in the point-wise convolution. For the channel-wise convolution, specify one filter per group. For point-wise convolution, specify filters of size 1 in convolution2dLayer.

```
cwsConvLayers = [  
  groupedConvolution2dLayer(filterSize,1,'channel-wise','Stride',2,'Padding','same')  
  batchNormalizationLayer  
  reluLayer  
  
  convolution2dLayer(1,numFilters,'Padding','same')
```



```
batchNormalizationLayer
reluLayer];
```

Create a network containing layers for channel-wise separable convolution.

```
layers = [
    imageInputLayer([227 227 3])

    convolution2dLayer(3,32,'Padding','same')
    batchNormalizationLayer
    reluLayer

    groupedConvolution2dLayer(3,1,'channel-wise','Stride',2,'Padding','same')
    batchNormalizationLayer
    reluLayer
    convolution2dLayer(1,16,'Padding','same')
    batchNormalizationLayer
    reluLayer

    maxPooling2dLayer(2,'Stride',2)

    fullyConnectedLayer(5)
    softmaxLayer
    classificationLayer];
```

## References

- [1] Glorot, Xavier, and Yoshua Bengio. "Understanding the difficulty of training deep feedforward neural networks." In *Proceedings of the thirteenth international conference on artificial intelligence and statistics*, pp. 249-256. 2010.
- [2] He, Kaiming, Xiangyu Zhang, Shaoqing Ren, and Jian Sun. "Delving deep into rectifiers: Surpassing human-level performance on imagenet classification." In *Proceedings of the IEEE international conference on computer vision*, pp. 1026-1034. 2015.

## Extended Capabilities

### GPU Code Generation

Generate CUDA® code for NVIDIA® GPUs using GPU Coder™.

### See Also

[batchNormalizationLayer](#) | [convolution2dLayer](#) | [fullyConnectedLayer](#) | [maxPooling2dLayer](#) | [reluLayer](#) | [trainNetwork](#)

### Topics

“Create Simple Deep Learning Network for Classification”  
 “Train Convolutional Neural Network for Regression”  
 “Deep Learning in MATLAB”  
 “Specify Layers of Convolutional Neural Network”  
 “Compare Layer Weight Initializers”  
 “List of Deep Learning Layers”

**Introduced in R2019a**

## gru

Gated recurrent unit

### Syntax

```
dLY = gru(dlX,H0,weights,recurrentWeights,bias)
[dLY,hiddenState] = gru(dlX,H0,weights,recurrentWeights,bias)
[ ___ ] = gru( ___ , 'DataFormat' ,FMT)
```

### Description

The gated recurrent unit (GRU) operation allows a network to learn dependencies between time steps in time series and sequence data.

---

**Note** This function applies the deep learning GRU operation to `dIarray` data. If you want to apply an GRU operation within a `layerGraph` object or `Layer` array, use the following layer:

- `gruLayer`
- 

`dLY = gru(dlX,H0,weights,recurrentWeights,bias)` applies a gated recurrent unit (GRU) calculation to input `dlX` using the initial hidden state `H0`, and parameters `weights`, `recurrentWeights`, and `bias`. The input `dlX` is a formatted `dIarray` with dimension labels. The output `dLY` is a formatted `dIarray` with the same dimension labels as `dlX`, except for any 'S' dimensions.

The `gru` function updates the hidden state using the hyperbolic tangent function ( $\tanh$ ) as the state activation function. The `gru` function uses the sigmoid function given by  $\sigma(x) = (1 + e^{-x})^{-1}$  as the gate activation function.

`[dLY,hiddenState] = gru(dlX,H0,weights,recurrentWeights,bias)` also returns the hidden state after the GRU operation.

`[ ___ ] = gru( ___ , 'DataFormat' ,FMT)` also specifies the dimension format `FMT` when `dlX` is not a formatted `dIarray`. The output `dLY` is an unformatted `dIarray` with the same dimension order as `dlX`, except for any 'S' dimensions.

### Examples

#### Apply GRU Operation to Sequence Data

Perform a GRU operation using 100 hidden units.

Create the input sequence data as 32 observations with ten channels and a sequence length of 64.

```
numFeatures = 10;
numObservations = 32;
```

```
sequenceLength = 64;
```

```
X = randn(numFeatures,numObservations,sequenceLength);  
dLX = dlarray(X,'CBT');
```

Create the initial hidden state with 100 hidden units. Use the same initial hidden state for all observations.

```
numHiddenUnits = 100;  
H0 = zeros(numHiddenUnits,1);
```

Create the learnable parameters for the GRU operation.

```
weights = dlarray(randn(3*numHiddenUnits,numFeatures));  
recurrentWeights = dlarray(randn(3*numHiddenUnits,numHiddenUnits));  
bias = dlarray(randn(3*numHiddenUnits,1));
```

Perform the GRU calculation.

```
[dLY,hiddenState] = gru(dLX,H0,weights,recurrentWeights,bias);
```

View the size and dimension labels of dLY.

```
size(dLY)  
ans = 1×3  
    100    32    64
```

```
dLY.dims
```

```
ans =  
'CBT'
```

View the size of hiddenState.

```
size(hiddenState)  
ans = 1×2  
    100    32
```

You can use the hidden state to keep track of the state of the GRU operation and input further sequential data.

## Input Arguments

### dLX — Input data

dlarray | numeric array

Input data, specified as a dlarray with or without dimension labels or a numeric array. When dLX is not a formatted dlarray, you must specify the dimension label format using 'DataFormat', FMT. If dLX is a numeric array, at least one of H0, weights, recurrentWeights, or bias must be a dlarray.

`dLX` must contain a sequence dimension labeled 'T'. If `dLX` has any spatial dimensions labeled 'S', they are flattened into the 'C' channel dimensions. If `dLX` has any unspecified dimensions labeled 'U', they must be singleton.

Data Types: `single` | `double`

### **H0 — Initial hidden state vector**

`dLarray` | numeric array

Initial hidden state vector, specified as a `dLarray` with or without dimension labels or a numeric array.

If `H0` is a formatted `dLarray`, it must contain a channel dimension labeled 'C' and optionally a batch dimension labeled 'B' with the same size as the 'B' dimension of `dLX`. If `H0` does not have a 'B' dimension, the function uses the same hidden state vector for each observation in `dLX`.

If `H0` is a formatted `dLarray`, then the size of the 'C' dimension determines the number of hidden units. Otherwise, the size of the first dimension determines the number of hidden units.

Data Types: `single` | `double`

### **weights — Weights**

`dLarray` | numeric array

Weights, specified as a `dLarray` with or without dimension labels or a numeric array.

Specify `weights` as a matrix of size `3*NumHiddenUnits-by-InputSize`, where `NumHiddenUnits` is the size of the 'C' dimension of `H0`, and `InputSize` is the size of the 'C' dimension of `dLX` multiplied by the size of each 'S' dimension of `dLX`, where present.

If `weights` is a formatted `dLarray`, it must contain a 'C' dimension of size `3*NumHiddenUnits` and a 'U' dimension of size `InputSize`.

Data Types: `single` | `double`

### **recurrentWeights — Recurrent weights**

`dLarray` | numeric array

Recurrent weights, specified as a `dLarray` with or without dimension labels or a numeric array.

Specify `recurrentWeights` as a matrix of size `3*NumHiddenUnits-by-NumHiddenUnits`, where `NumHiddenUnits` is the size of the 'C' dimension of `H0`.

If `recurrentWeights` is a formatted `dLarray`, it must contain a 'C' dimension of size `3*NumHiddenUnits` and a 'U' dimension of size `NumHiddenUnits`.

Data Types: `single` | `double`

### **bias — Bias**

`dLarray vector` | numeric vector

Bias, specified as a `dLarray vector` with or without dimension labels or a numeric vector.

Specify `bias` as a vector of length `3*NumHiddenUnits`, where `NumHiddenUnits` is the size of the 'C' dimension of `H0`.

If `bias` is a formatted `dLarray`, the nonsingleton dimension must be labeled with 'C'.

Data Types: `single` | `double`

### **FMT — Dimension order of unformatted data**

`char array` | `string`

Dimension order of unformatted input data, specified as the comma-separated pair consisting of 'DataFormat' and a character array or string FMT that provides a label for each dimension of the data. Each character in FMT must be one of the following:

- 'S' — Spatial
- 'C' — Channel
- 'B' — Batch (for example, samples and observations)
- 'T' — Time (for example, sequences)
- 'U' — Unspecified

You can specify multiple dimensions labeled 'S' or 'U'. You can use the labels 'C', 'B', and 'T' at most once.

You must specify 'DataFormat', FMT when the input data `dLX` is not a formatted `dLarray`.

Example: 'DataFormat', 'SSCB'

Data Types: `char` | `string`

## **Output Arguments**

### **dLY — GRU output**

`dLarray`

GRU output, returned as a `dLarray`. The output `dLY` has the same underlying data type as the input `dLX`.

If the input data `dLX` is a formatted `dLarray`, `dLY` has the same dimension labels as `dLX`, except for any 'S' dimensions. If the input data is not a formatted `dLarray`, `dLY` is an unformatted `dLarray` with the same dimension order as the input data.

The size of the 'C' dimension of `dLY` is the same as the number of hidden units, specified by the size of the 'C' dimension of `H0`.

### **hiddenState — Hidden state vector**

`dLarray` | `numeric array`

Hidden state vector for each observation, returned as a `dLarray` or a numeric array with the same data type as `H0`.

If the input `H0` is a formatted `dLarray`, then the output `hiddenState` is a formatted `dLarray` with the format 'CB'.

## **Limitations**

- `functionToLayerGraph` does not support the `gru` function. If you use `functionToLayerGraph` with a function that contains the `gru` operation, the resulting `LayerGraph` contains placeholder layers.

## More About

### Gated Recurrent Unit

The GRU operation allows a network to learn dependencies between time steps in time series and sequence data. For more information, see the “Gated Recurrent Unit Layer” on page 1-446 definition on the `gruLayer` reference page.

## References

- [1] Cho, Kyunghyun, Bart Van Merriënboer, Caglar Gulcehre, Dzmitry Bahdanau, Fethi Bougares, Holger Schwenk, and Yoshua Bengio. "Learning phrase representations using RNN encoder-decoder for statistical machine translation." *arXiv preprint arXiv:1406.1078* (2014).

## Extended Capabilities

### GPU Arrays

Accelerate code by running on a graphics processing unit (GPU) using Parallel Computing Toolbox™.

Usage notes and limitations:

- When at least one of the following input arguments is a `gpuArray` or a `dlarray` with underlying data of type `gpuArray`, this function runs on the GPU:
  - `dlX`
  - `H0`
  - `weights`
  - `recurrentWeights`
  - `bias`

For more information, see “Run MATLAB Functions on a GPU” (Parallel Computing Toolbox).

## See Also

`dlarray` | `dlfeval` | `dlgradient` | `fullyconnect` | `lstm` | `softmax`

### Topics

“Define Custom Training Loops, Loss Functions, and Networks”

“Train Network Using Model Function”

“Sequence-to-Sequence Translation Using Attention”

“Multilabel Text Classification Using Deep Learning”

### Introduced in R2020a

## gruLayer

Gated recurrent unit (GRU) layer

### Description

A GRU layer learns dependencies between time steps in time series and sequence data.

### Creation

#### Syntax

```
layer = gruLayer(numHiddenUnits)
layer = gruLayer(numHiddenUnits,Name,Value)
```

#### Description

`layer = gruLayer(numHiddenUnits)` creates a GRU layer and sets the `NumHiddenUnits` property.

`layer = gruLayer(numHiddenUnits,Name,Value)` sets additional `OutputMode`, “Activations” on page 1-439, “State” on page 1-440, “Parameters and Initialization” on page 1-440, “Learn Rate and Regularization” on page 1-442, and `Name` properties using one or more name-value pair arguments. You can specify multiple name-value pair arguments. Enclose each property name in quotes.

### Properties

#### GRU

##### **NumHiddenUnits — Number of hidden units**

positive integer

Number of hidden units (also known as the hidden size), specified as a positive integer.

The number of hidden units corresponds to the amount of information remembered between time steps (the hidden state). The hidden state can contain information from all previous time steps, regardless of the sequence length. If the number of hidden units is too large, then the layer might overfit to the training data. This value can vary from a few dozen to a few thousand.

The hidden state does not limit the number of time steps that are processed in an iteration. To split your sequences into smaller sequences for training, use the `'SequenceLength'` option in `trainingOptions`.

Example: 200

##### **OutputMode — Format of output**

`'sequence'` (default) | `'last'`



Format of output, specified as one of the following:

- 'sequence' - Output the complete sequence.
- 'last' - Output the last time step of the sequence.

### ResetGateMode — Reset gate mode

'after-multiplication' (default) | 'before-multiplication'

Reset gate mode, specified as one of the following:

- 'after-multiplication' - Apply reset gate after matrix multiplication. This option is cuDNN compatible.
- 'before-multiplication' - Apply reset gate before matrix multiplication.

For more information about the reset gate calculations, see “Gated Recurrent Unit Layer” on page 1-446.

### InputSize — Input size

'auto' (default) | positive integer

Input size, specified as a positive integer or 'auto'. If InputSize is 'auto', then the software automatically assigns the input size at training time.

Example: 100

## Activations

### StateActivationFunction — Activation function to update the hidden state

'tanh' (default) | 'softsign'

Activation function to update the hidden state, specified as one of the following:

- 'tanh' - Use the hyperbolic tangent function (tanh).
- 'softsign' - Use the softsign function  $\text{softsign}(x) = \frac{x}{1 + |x|}$ .

The layer uses this option as the function  $\sigma_s$  in the calculations to update the hidden state.

### GateActivationFunction — Activation function to apply to the gates

'sigmoid' (default) | 'hard-sigmoid'

Activation function to apply to the gates, specified as one of the following:

- 'sigmoid' - Use the sigmoid function  $\sigma(x) = (1 + e^{-x})^{-1}$ .
- 'hard-sigmoid' - Use the hard sigmoid function

$$\sigma(x) = \begin{cases} 0 & \text{if } x < -2.5 \\ 0.2x + 0.5 & \text{if } -2.5 \leq x \leq 2.5 \\ 1 & \text{if } x > 2.5 \end{cases}$$

The layer uses this option as the function  $\sigma_g$  in the calculations for the layer gates.

## State

### HiddenState — Initial value of the hidden state

numeric vector

Initial value of the hidden state, specified as a NumHiddenUnits-by-1 numeric vector. This value corresponds to the hidden state at time step 0.

After setting this property, calls to the `resetState` function set the hidden state to this value.

### Parameters and Initialization

#### InputWeightsInitializer — Function to initialize input weights

'glorot' (default) | 'he' | 'orthogonal' | 'narrow-normal' | 'zeros' | 'ones' | function handle

Function to initialize the input weights, specified as one of the following:

- 'glorot' - Initialize the input weights with the Glorot initializer [2] (also known as Xavier initializer). The Glorot initializer independently samples from a uniform distribution with zero mean and variance  $2/(InputSize + numOut)$ , where  $numOut = 3*NumHiddenUnits$ .
- 'he' - Initialize the input weights with the He initializer [3]. The He initializer samples from a normal distribution with zero mean and variance  $2/InputSize$ .
- 'orthogonal' - Initialize the input weights with  $Q$ , the orthogonal matrix given by the QR decomposition of  $Z = QR$  for a random matrix  $Z$  sampled from a unit normal distribution. [4]
- 'narrow-normal' - Initialize the input weights by independently sampling from a normal distribution with zero mean and standard deviation 0.01.
- 'zeros' - Initialize the input weights with zeros.
- 'ones' - Initialize the input weights with ones.
- Function handle - Initialize the input weights with a custom function. If you specify a function handle, then the function must be of the form `weights = func(sz)`, where `sz` is the size of the input weights.

The layer only initializes the input weights when the `InputWeights` property is empty.

Data Types: char | string | function\_handle

#### RecurrentWeightsInitializer — Function to initialize recurrent weights

'orthogonal' (default) | 'glorot' | 'he' | 'narrow-normal' | 'zeros' | 'ones' | function handle

Function to initialize the recurrent weights, specified as one of the following:

- 'orthogonal' - Initialize the recurrent weights with  $Q$ , the orthogonal matrix given by the QR decomposition of  $Z = QR$  for a random matrix  $Z$  sampled from a unit normal distribution. [4]
- 'glorot' - Initialize the recurrent weights with the Glorot initializer [2] (also known as Xavier initializer). The Glorot initializer independently samples from a uniform distribution with zero mean and variance  $2/(numIn + numOut)$ , where  $numIn = NumHiddenUnits$  and  $numOut = 3*NumHiddenUnits$ .
- 'he' - Initialize the recurrent weights with the He initializer [3]. The He initializer samples from a normal distribution with zero mean and variance  $2/NumHiddenUnits$ .

- 'narrow-normal' - Initialize the recurrent weights by independently sampling from a normal distribution with zero mean and standard deviation 0.01.
- 'zeros' - Initialize the recurrent weights with zeros.
- 'ones' - Initialize the recurrent weights with ones.
- Function handle - Initialize the recurrent weights with a custom function. If you specify a function handle, then the function must be of the form `weights = func(sz)`, where `sz` is the size of the recurrent weights.

The layer only initializes the recurrent weights when the `RecurrentWeights` property is empty.

Data Types: `char` | `string` | `function_handle`

### **BiasInitializer — Function to initialize bias**

'zeros' (default) | 'narrow-normal' | 'ones' | function handle

Function to initialize the bias, specified as one of the following:

- 'zeros' - Initialize the bias with zeros.
- 'narrow-normal' - Initialize the bias by independently sampling from a normal distribution with zero mean and standard deviation 0.01.
- 'ones' - Initialize the bias with ones.
- Function handle - Initialize the bias with a custom function. If you specify a function handle, then the function must be of the form `bias = func(sz)`, where `sz` is the size of the bias.

The layer only initializes the bias when the `Bias` property is empty.

Data Types: `char` | `string` | `function_handle`

### **InputWeights — Input weights**

[] (default) | matrix

Input weights, specified as a matrix.

The input weight matrix is a concatenation of the three input weight matrices for the components in the GRU layer. The three matrices are concatenated vertically in the following order:

- 1 Reset gate
- 2 Update gate
- 3 Candidate state

The input weights are learnable parameters. When training a network, if `InputWeights` is nonempty, then `trainNetwork` uses the `InputWeights` property as the initial value. If `InputWeights` is empty, then `trainNetwork` uses the initializer specified by `InputWeightsInitializer`.

At training time, `InputWeights` is a  $3 \times \text{NumHiddenUnits}$ -by-`InputSize` matrix.

### **RecurrentWeights — Recurrent weights**

[] (default) | matrix

Recurrent weights, specified as a matrix.

The recurrent weight matrix is a concatenation of the three recurrent weight matrices for the components in the GRU layer. The three matrices are vertically concatenated in the following order:

- 1 Reset gate
- 2 Update gate
- 3 Candidate state

The recurrent weights are learnable parameters. When training a network, if `RecurrentWeights` is nonempty, then `trainNetwork` uses the `RecurrentWeights` property as the initial value. If `RecurrentWeights` is empty, then `trainNetwork` uses the initializer specified by `RecurrentWeightsInitializer`.

At training time `RecurrentWeights` is a  $3 \times \text{NumHiddenUnits}$ -by- $\text{NumHiddenUnits}$  matrix.

### **Bias – Layer biases**

`[]` (default) | numeric vector

Layer biases for the GRU layer, specified as a numeric vector.

The bias vector is a concatenation of the three bias vectors for the components in the GRU layer. The three vectors are concatenated vertically in the following order:

- 1 Reset gate
- 2 Update gate
- 3 Candidate state

The layer biases are learnable parameters. When training a network, if `Bias` is nonempty, then `trainNetwork` uses the `Bias` property as the initial value. If `Bias` is empty, then `trainNetwork` uses the initializer specified by `BiasInitializer`.

At training time, `Bias` is a  $3 \times \text{NumHiddenUnits}$ -by-1 numeric vector.

### **Learn Rate and Regularization**

#### **InputWeightsLearnRateFactor – Learning rate factor for input weights**

1 (default) | numeric scalar | 1-by-3 numeric vector

Learning rate factor for the input weights, specified as a numeric scalar or a 1-by-3 numeric vector.

The software multiplies this factor by the global learning rate to determine the learning rate factor for the input weights of the layer. For example, if `InputWeightsLearnRateFactor` is 2, then the learning rate factor for the input weights of the layer is twice the current global learning rate. The software determines the global learning rate based on the settings specified with the `trainingOptions` function.

To control the value of the learning rate factor for the three individual matrices in `InputWeights`, specify a 1-by-3 vector. The entries of `InputWeightsLearnRateFactor` correspond to the learning rate factor of the following:

- 1 Reset gate
- 2 Update gate
- 3 Candidate state

To specify the same value for all the matrices, specify a nonnegative scalar.

Example: 2

Example: [1 2 1]

### **RecurrentWeightsLearnRateFactor — Learning rate factor for recurrent weights**

1 (default) | numeric scalar | 1-by-3 numeric vector

Learning rate factor for the recurrent weights, specified as a numeric scalar or a 1-by-3 numeric vector.

The software multiplies this factor by the global learning rate to determine the learning rate for the recurrent weights of the layer. For example, if `RecurrentWeightsLearnRateFactor` is 2, then the learning rate for the recurrent weights of the layer is twice the current global learning rate. The software determines the global learning rate based on the settings specified with the `trainingOptions` function.

To control the value of the learning rate factor for the three individual matrices in `RecurrentWeights`, specify a 1-by-3 vector. The entries of `RecurrentWeightsLearnRateFactor` correspond to the learning rate factor of the following:

- 1 Reset gate
- 2 Update gate
- 3 Candidate state

To specify the same value for all the matrices, specify a nonnegative scalar.

Example: 2

Example: [1 2 1]

### **BiasLearnRateFactor — Learning rate factor for biases**

1 (default) | nonnegative scalar | 1-by-3 numeric vector

Learning rate factor for the biases, specified as a nonnegative scalar or a 1-by-3 numeric vector.

The software multiplies this factor by the global learning rate to determine the learning rate for the biases in this layer. For example, if `BiasLearnRateFactor` is 2, then the learning rate for the biases in the layer is twice the current global learning rate. The software determines the global learning rate based on the settings specified with the `trainingOptions` function.

To control the value of the learning rate factor for the three individual matrices in `Bias`, specify a 1-by-3 vector. The entries of `BiasLearnRateFactor` correspond to the learning rate factor of the following:

- 1 Reset gate
- 2 Update gate
- 3 Candidate state

To specify the same value for all the matrices, specify a nonnegative scalar.

Example: 2

Example: [1 2 1]

### **InputWeightsL2Factor — L2 regularization factor for input weights**

1 (default) | numeric scalar | 1-by-3 numeric vector

L2 regularization factor for the input weights, specified as a numeric scalar or a 1-by-3 numeric vector.

The software multiplies this factor by the global L2 regularization factor to determine the L2 regularization factor for the input weights of the layer. For example, if `InputWeightsL2Factor` is 2, then the L2 regularization factor for the input weights of the layer is twice the current global L2 regularization factor. The software determines the L2 regularization factor based on the settings specified with the `trainingOptions` function.

To control the value of the L2 regularization factor for the three individual matrices in `InputWeights`, specify a 1-by-3 vector. The entries of `InputWeightsL2Factor` correspond to the L2 regularization factor of the following:

- 1** Reset gate
- 2** Update gate
- 3** Candidate state

To specify the same value for all the matrices, specify a nonnegative scalar.

Example: 2

Example: [1 2 1]

### **RecurrentWeightsL2Factor — L2 regularization factor for recurrent weights**

1 (default) | numeric scalar | 1-by-3 numeric vector

L2 regularization factor for the recurrent weights, specified as a numeric scalar or a 1-by-3 numeric vector.

The software multiplies this factor by the global L2 regularization factor to determine the L2 regularization factor for the recurrent weights of the layer. For example, if `RecurrentWeightsL2Factor` is 2, then the L2 regularization factor for the recurrent weights of the layer is twice the current global L2 regularization factor. The software determines the L2 regularization factor based on the settings specified with the `trainingOptions` function.

To control the value of the L2 regularization factor for the three individual matrices in `RecurrentWeights`, specify a 1-by-3 vector. The entries of `RecurrentWeightsL2Factor` correspond to the L2 regularization factor of the following:

- 1** Reset gate
- 2** Update gate
- 3** Candidate state

To specify the same value for all the matrices, specify a nonnegative scalar.

Example: 2

Example: [1 2 1]

### **BiasL2Factor — L2 regularization factor for biases**

0 (default) | nonnegative scalar | 1-by-3 numeric vector

L2 regularization factor for the biases, specified as a nonnegative scalar or a 1-by-3 numeric vector.

The software multiplies this factor by the global L2 regularization factor to determine the L2 regularization for the biases in this layer. For example, if `BiasL2Factor` is 2, then the L2

regularization for the biases in this layer is twice the global L2 regularization factor. You can specify the global L2 regularization factor using the `trainingOptions` function.

To control the value of the L2 regularization factor for the three individual matrices in `Bias`, specify a 1-by-3 vector. The entries of `BiasL2Factor` correspond to the L2 regularization factor of the following:

- 1 Reset gate
- 2 Update gate
- 3 Candidate state

To specify the same value for all the matrices, specify a nonnegative scalar.

Example: 2

Example: [1 2 1]

## Layer

### Name — Layer name

' ' (default) | character vector | string scalar

Layer name, specified as a character vector or a string scalar. If `Name` is set to ' ', then the software automatically assigns a name at training time.

Data Types: `char` | `string`

### NumInputs — Number of inputs

1 (default)

Number of inputs of the layer. This layer accepts a single input only.

Data Types: `double`

### InputNames — Input names

{ 'in' } (default)

Input names of the layer. This layer accepts a single input only.

Data Types: `cell`

### NumOutputs — Number of outputs

1 (default)

Number of outputs of the layer. This layer has a single output only.

Data Types: `double`

### OutputNames — Output names

{ 'out' } (default)

Output names of the layer. This layer has a single output only.

Data Types: `cell`

## Examples

## Create GRU Layer

Create a GRU layer with the name 'gru1' and 100 hidden units.

```
layer = gruLayer(100, 'Name', 'gru1')  
  
layer =  
  GRULayer with properties:  
  
      Name: 'gru1'  
  
  Hyperparameters  
      InputSize: 'auto'  
      NumHiddenUnits: 100  
      OutputMode: 'sequence'  
  StateActivationFunction: 'tanh'  
  GateActivationFunction: 'sigmoid'  
  
  Learnable Parameters  
      InputWeights: []  
      RecurrentWeights: []  
      Bias: []  
  
  State Parameters  
      HiddenState: []  
  
  Show all properties
```

Include a GRU layer in a Layer array.

```
inputSize = 12;  
numHiddenUnits = 100;  
numClasses = 9;  
  
layers = [ ...  
  sequenceInputLayer(inputSize)  
  gruLayer(numHiddenUnits)  
  fullyConnectedLayer(numClasses)  
  softmaxLayer  
  classificationLayer]  
  
layers =  
  5x1 Layer array with layers:  
  
   1  ''  Sequence Input           Sequence input with 12 dimensions  
   2  ''  GRU                     GRU with 100 hidden units  
   3  ''  Fully Connected         9 fully connected layer  
   4  ''  Softmax                 softmax  
   5  ''  Classification Output   crossentropyex
```

## More About

### Gated Recurrent Unit Layer

A GRU layer learns dependencies between time steps in time series and sequence data.



The *hidden state* of the layer at time step  $t$  contains the output of the GRU layer for this time step. At each time step, the layer adds information to or removes information from the state. The layer controls these updates using *gates*.

The following components control the hidden state of the layer.

Component	Purpose
Update gate ( $z$ )	Control level of state update
Reset gate ( $r$ )	Control level of state reset
Candidate state ( $\tilde{h}$ )	Control level of update added to hidden state

The learnable weights of a GRU layer are the input weights  $W$  (**InputWeights**), the recurrent weights  $R$  (**RecurrentWeights**), and the bias  $b$  (**Bias**). The matrices  $W$ ,  $R$ , and  $b$  are concatenations of the input weights, the recurrent weights, and the bias of each component, respectively. These matrices are concatenated as follows:

$$W = \begin{bmatrix} W_z \\ W_r \\ W_{\tilde{h}} \end{bmatrix}, R = \begin{bmatrix} R_z \\ R_r \\ R_{\tilde{h}} \end{bmatrix}, b = \begin{bmatrix} b_z \\ b_r \\ b_{\tilde{h}} \end{bmatrix},$$

where  $z$ ,  $r$ , and  $\tilde{h}$  denote the update gate, reset gate, and output gate, respectively.

The hidden state at time step  $t$  is given by

$$\mathbf{h}_t = (1 - z_t) \odot \mathbf{h}_{t-1} + z_t \odot \tilde{\mathbf{h}}_t.$$

The following formulas describe the components at time step  $t$ .

Component	Formula
Update gate	$z_t = \sigma_g(W_z \mathbf{x}_t + R_z \mathbf{h}_{t-1} + b_z)$
Reset gate	$r_t = \sigma_g(W_r \mathbf{x}_t + R_r \mathbf{h}_{t-1} + b_r)$
Candidate state (when ResetGateMode is 'after-multiplication')	$\tilde{\mathbf{h}}_t = \sigma_s(W_{\tilde{h}} \mathbf{x}_t + r_t \odot (R_{\tilde{h}} \mathbf{h}_{t-1}) + b_{\tilde{h}})$
Candidate state (when ResetGateMode is 'before-multiplication')	$\tilde{\mathbf{h}}_t = \sigma_s(W_{\tilde{h}} \mathbf{x}_t + R_{\tilde{h}} (r_t \odot \mathbf{h}_{t-1}) + b_{\tilde{h}})$

In these calculations,  $\sigma_g$  and  $\sigma_s$  denotes the gate and state activation functions, respectively. The `gruLayer` function, by default, uses the sigmoid function given by  $\sigma(x) = (1 + e^{-x})^{-1}$  to compute the gate activation function and the hyperbolic tangent function ( $\tanh$ ) to compute the state activation function.

## References

- [1] Cho, Kyunghyun, Bart Van Merriënboer, Caglar Gulcehre, Dzmitry Bahdanau, Fethi Bougares, Holger Schwenk, and Yoshua Bengio. "Learning phrase representations using RNN encoder-decoder for statistical machine translation." *arXiv preprint arXiv:1406.1078* (2014).

- [2] Glorot, Xavier, and Yoshua Bengio. "Understanding the difficulty of training deep feedforward neural networks." In *Proceedings of the thirteenth international conference on artificial intelligence and statistics*, pp. 249-256. 2010.
- [3] He, Kaiming, Xiangyu Zhang, Shaoqing Ren, and Jian Sun. "Delving deep into rectifiers: Surpassing human-level performance on imagenet classification." In *Proceedings of the IEEE international conference on computer vision*, pp. 1026-1034. 2015.
- [4] Saxe, Andrew M., James L. McClelland, and Surya Ganguli. "Exact solutions to the nonlinear dynamics of learning in deep linear neural networks." *arXiv preprint arXiv:1312.6120* (2013).

## See Also

`bilstmLayer` | `classifyAndUpdateState` | `flattenLayer` | `lstmLayer` |  
`predictAndUpdateState` | `resetState` | `sequenceFoldingLayer` | `sequenceInputLayer` |  
`sequenceUnfoldingLayer`

## Topics

"Sequence Classification Using Deep Learning"  
"Time Series Forecasting Using Deep Learning"  
"Sequence-to-Sequence Classification Using Deep Learning"  
"Sequence-to-Sequence Regression Using Deep Learning"  
"Classify Videos Using Deep Learning"  
"Visualize Activations of LSTM Network"  
"Long Short-Term Memory Networks"  
"Compare Layer Weight Initializers"  
"Deep Learning in MATLAB"  
"List of Deep Learning Layers"

## Introduced in R2020a

# imageDataAugmenter

Configure image data augmentation

## Description

An image data augmenter configures a set of preprocessing options for image augmentation, such as resizing, rotation, and reflection.

The `imageDataAugmenter` is used by an `augmentedImageDatastore` to generate batches of augmented images. For more information, see “Augment Images for Training with Random Geometric Transformations”.

## Creation

### Syntax

```
aug = imageDataAugmenter
aug = imageDataAugmenter(Name,Value)
```

### Description

`aug = imageDataAugmenter` creates an `imageDataAugmenter` object with default property values consistent with the identity transformation.

`aug = imageDataAugmenter(Name,Value)` configures a set of image augmentation options using name-value pairs to set properties on page 1-449. You can specify multiple name-value pairs. Enclose each property name in quotes.

## Properties

### FillValue — Fill value

numeric scalar | numeric vector

Fill value used to define out-of-bounds points when resampling, specified as a numeric scalar or numeric vector.

- If the augmented images are single channel, then `FillValue` must be a scalar.
- If the augmented images are multichannel, then `FillValue` can be a scalar or a vector with length equal to the number of channels of the input image. For example, if the input image is an RGB image, `FillValue` can be a vector of length 3.

For grayscale and color images, the default fill value is 0. For categorical images, the default fill value is an '<undefined>' label and `trainNetwork` ignores filled pixels when training.

Example: 128

### RandXReflection — Random reflection

false (default) | true

Random reflection in the left-right direction, specified as a logical scalar. When `RandXReflection` is `true` (1), each image is reflected horizontally with 50% probability. When `RandXReflection` is `false` (0), no images are reflected.

**RandYReflection — Random reflection**

`false` (default) | `true`

Random reflection in the top-bottom direction, specified as a logical scalar. When `RandYReflection` is `true` (1), each image is reflected vertically with 50% probability. When `RandYReflection` is `false` (0), no images are reflected.

**RandRotation — Range of rotation**

`[0 0]` (default) | 2-element numeric vector | function handle

Range of rotation, in degrees, applied to the input image, specified as one of the following.

- 2-element numeric vector. The second element must be larger than or equal to the first element. The rotation angle is picked randomly from a continuous uniform distribution within the specified interval.
- function handle. The function must accept no input arguments and return the rotation angle as a numeric scalar. Use a function handle to pick rotation angles from a disjoint interval or using a nonuniform probability distribution. For more information about function handles, see “Create Function Handle” (MATLAB).

By default, augmented images are not rotated.

Example: `[-45 45]`

**RandScale — Range of uniform scaling**

`[1 1]` (default) | 2-element numeric vector | function handle

Range of uniform (isotropic) scaling applied to the input image, specified as one of the following.

- 2-element numeric vector. The second element must be larger than or equal to the first element. The scale factor is picked randomly from a continuous uniform distribution within the specified interval.
- function handle. The function must accept no input arguments and return the scale factor as a numeric scalar. Use a function handle to pick scale factors from a disjoint interval or using a nonuniform probability distribution. For more information about function handles, see “Create Function Handle” (MATLAB).

By default, augmented images are not scaled.

Example: `[0.5 4]`

**RandXScale — Range of horizontal scaling**

`[1 1]` (default) | 2-element vector of positive numbers | function handle

Range of horizontal scaling applied to the input image, specified as one of the following.

- 2-element numeric vector. The second element must be larger than or equal to the first element. The horizontal scale factor is picked randomly from a continuous uniform distribution within the specified interval.
- function handle. The function must accept no input arguments and return the horizontal scale factor as a numeric scalar. Use a function handle to pick horizontal scale factors from a disjoint

interval or using a nonuniform probability distribution. For more information about function handles, see “Create Function Handle” (MATLAB).

By default, augmented images are not scaled in the horizontal direction.

---

**Note** If you specify `RandScale`, then `imageDataAugmenter` ignores the value of `RandXScale` when scaling images.

---

Example: `[0.5 4]`

### **RandYScale — Range of vertical scaling**

`[1 1]` (default) | 2-element vector of positive numbers | function handle

Range of vertical scaling applied to the input image, specified as one of the following.

- 2-element numeric vector. The second element must be larger than or equal to the first element. The vertical scale factor is picked randomly from a continuous uniform distribution within the specified interval.
- function handle. The function must accept no input arguments and return the vertical scale factor as a numeric scalar. Use a function handle to pick vertical scale factors from a disjoint interval or using a nonuniform probability distribution. For more information about function handles, see “Create Function Handle” (MATLAB).

By default, augmented images are not scaled in the vertical direction.

---

**Note** If you specify `RandScale`, then `imageDataAugmenter` ignores the value of `RandYScale` when scaling images.

---

Example: `[0.5 4]`

### **RandXShear — Range of horizontal shear**

`[0 0]` (default) | 2-element numeric vector | function handle

Range of horizontal shear applied to the input image, specified as one of the following. Shear is measured as an angle in degrees, and is in the range  $(-90, 90)$ .

- 2-element numeric vector. The second element must be larger than or equal to the first element. The horizontal shear angle is picked randomly from a continuous uniform distribution within the specified interval.
- function handle. The function must accept no input arguments and return the horizontal shear angle as a numeric scalar. Use a function handle to pick horizontal shear angles from a disjoint interval or using a nonuniform probability distribution. For more information about function handles, see “Create Function Handle” (MATLAB).

By default, augmented images are not sheared in the horizontal direction.

Example: `[0 45]`

### **RandYShear — Range of vertical shear**

`[0 0]` (default) | 2-element numeric vector | function handle

Range of vertical shear applied to the input image, specified as one of the following. Shear is measured as an angle in degrees, and is in the range (-90, 90).

- 2-element numeric vector. The second element must be larger than or equal to the first element. The vertical shear angle is picked randomly from a continuous uniform distribution within the specified interval.
- function handle. The function must accept no input arguments and return the vertical shear angle as a numeric scalar. Use a function handle to pick vertical shear angles from a disjoint interval or using a nonuniform probability distribution. For more information about function handles, see “Create Function Handle” (MATLAB).

By default, augmented images are not sheared in the vertical direction.

Example: [0 45]

### **RandXTranslation — Range of horizontal translation**

[0 0] (default) | 2-element numeric vector | function handle

Range of horizontal translation applied to the input image, specified as one of the following. Translation distance is measured in pixels.

- 2-element numeric vector. The second element must be larger than or equal to the first element. The horizontal translation distance is picked randomly from a continuous uniform distribution within the specified interval.
- function handle. The function must accept no input arguments and return the horizontal translation distance as a numeric scalar. Use a function handle to pick horizontal translation distances from a disjoint interval or using a nonuniform probability distribution. For more information about function handles, see “Create Function Handle” (MATLAB).

By default, augmented images are not translated in the horizontal direction.

Example: [-5 5]

### **RandYTranslation — Range of vertical translation**

[0 0] (default) | 2-element numeric vector | function handle

Range of vertical translation applied to the input image, specified as one of the following. Translation distance is measured in pixels.

- 2-element numeric vector. The second element must be larger than or equal to the first element. The vertical translation distance is picked randomly from a continuous uniform distribution within the specified interval.
- function handle. The function must accept no input arguments and return the vertical translation distance as a numeric scalar. Use a function handle to pick vertical translation distances from a disjoint interval or using a nonuniform probability distribution. For more information about function handles, see “Create Function Handle” (MATLAB).

By default, augmented images are not translated in the vertical direction.

Example: [-5 5]

## **Object Functions**

augment Apply identical random transformations to multiple images

## Examples

### Create Image Data Augmenter to Resize and Rotate Images

Create an image data augmenter that preprocesses images before training. This augmenter rotates images by random angles in the range [0, 360] degrees and resizes images by random scale factors in the range [0.5, 1].

```
augmenter = imageDataAugmenter( ...
    'RandRotation',[0 360], ...
    'RandScale',[0.5 1])

augmenter =
    imageDataAugmenter with properties:

        FillValue: 0
        RandXReflection: 0
        RandYReflection: 0
        RandRotation: [0 360]
        RandScale: [0.5000 1]
        RandXScale: [1 1]
        RandYScale: [1 1]
        RandXShear: [0 0]
        RandYShear: [0 0]
        RandXTranslation: [0 0]
        RandYTranslation: [0 0]
```

Create an augmented image datastore using the image data augmenter. The augmented image datastore also requires sample data, labels, and an output image size.

```
[XTrain,YTrain] = digitTrain4DArrayData;
imageSize = [56 56 1];
auimds = augmentedImageDatastore(imageSize,XTrain,YTrain,'DataAugmentation',augmenter)

auimds =
    augmentedImageDatastore with properties:

        NumObservations: 5000
        MiniBatchSize: 128
        DataAugmentation: [1x1 imageDataAugmenter]
        ColorPreprocessing: 'none'
        OutputSize: [56 56]
        OutputSizeMode: 'resize'
        DispatchInBackground: 0
```

Preview the random transformations applied to the first eight images in the image datastore.

```
minibatch = preview(auimds);
imshow(imtile(minibatch.input));
```

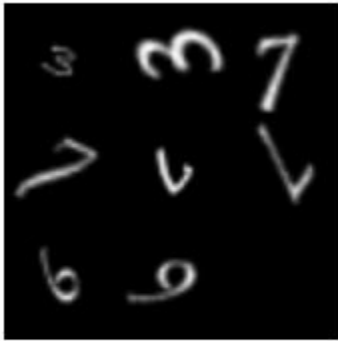

Preview different random transformations applied to the same set of images.

```
minibatch = preview(auimds);  
imshow(imtile(minibatch.input));
```

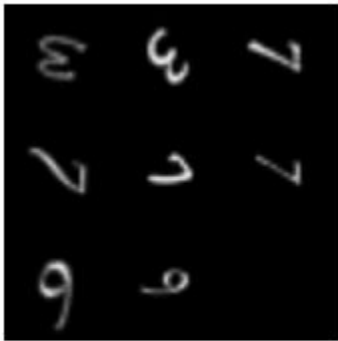

## Train Network with Augmented Images

Train a convolutional neural network using augmented image data. Data augmentation helps prevent the network from overfitting and memorizing the exact details of the training images.

Load the sample data, which consists of synthetic images of handwritten digits.

```
[XTrain,YTrain] = digitTrain4DArrayData;
```

`digitTrain4DArrayData` loads the digit training set as 4-D array data. `XTrain` is a 28-by-28-by-1-by-5000 array, where:

- 28 is the height and width of the images.



- 1 is the number of channels.
- 5000 is the number of synthetic images of handwritten digits.

YTrain is a categorical vector containing the labels for each observation.

Set aside 1000 of the images for network validation.

```
idx = randperm(size(XTrain,4),1000);
XValidation = XTrain(:,:,,idx);
XTrain(:,:,,idx) = [];
YValidation = YTrain(idx);
YTrain(idx) = [];
```

Create an `imageDataAugmenter` object that specifies preprocessing options for image augmentation, such as resizing, rotation, translation, and reflection. Randomly translate the images up to three pixels horizontally and vertically, and rotate the images with an angle up to 20 degrees.

```
imageAugmenter = imageDataAugmenter( ...
    'RandRotation',[-20,20], ...
    'RandXTranslation',[-3 3], ...
    'RandYTranslation',[-3 3])
```

```
imageAugmenter =
    imageDataAugmenter with properties:
```

```
    FillValue: 0
    RandXReflection: 0
    RandYReflection: 0
    RandRotation: [-20 20]
    RandScale: [1 1]
    RandXScale: [1 1]
    RandYScale: [1 1]
    RandXShear: [0 0]
    RandYShear: [0 0]
    RandXTranslation: [-3 3]
    RandYTranslation: [-3 3]
```

Create an `augmentedImageDatastore` object to use for network training and specify the image output size. During training, the datastore performs image augmentation and resizes the images. The datastore augments the images without saving any images to memory. `trainNetwork` updates the network parameters and then discards the augmented images.

```
imageSize = [28 28 1];
augimds = augmentedImageDatastore(imageSize,XTrain,YTrain,'DataAugmentation',imageAugmenter);
```

Specify the convolutional neural network architecture.

```
layers = [
    imageInputLayer(imageSize)

    convolution2dLayer(3,8,'Padding','same')
    batchNormalizationLayer
    reluLayer

    maxPooling2dLayer(2,'Stride',2)

    convolution2dLayer(3,16,'Padding','same')
```

```
batchNormalizationLayer
reluLayer

maxPooling2dLayer(2, 'Stride', 2)

convolution2dLayer(3, 32, 'Padding', 'same')
batchNormalizationLayer
reluLayer

fullyConnectedLayer(10)
softmaxLayer
classificationLayer];
```

Specify training options for stochastic gradient descent with momentum.

```
opts = trainingOptions('sgdm', ...
    'MaxEpochs', 15, ...
    'Shuffle', 'every-epoch', ...
    'Plots', 'training-progress', ...
    'Verbose', false, ...
    'ValidationData', {XValidation, YValidation});
```

Train the network. Because the validation images are not augmented, the validation accuracy is higher than the training accuracy.

```
net = trainNetwork(augimds, layers, opts);
```

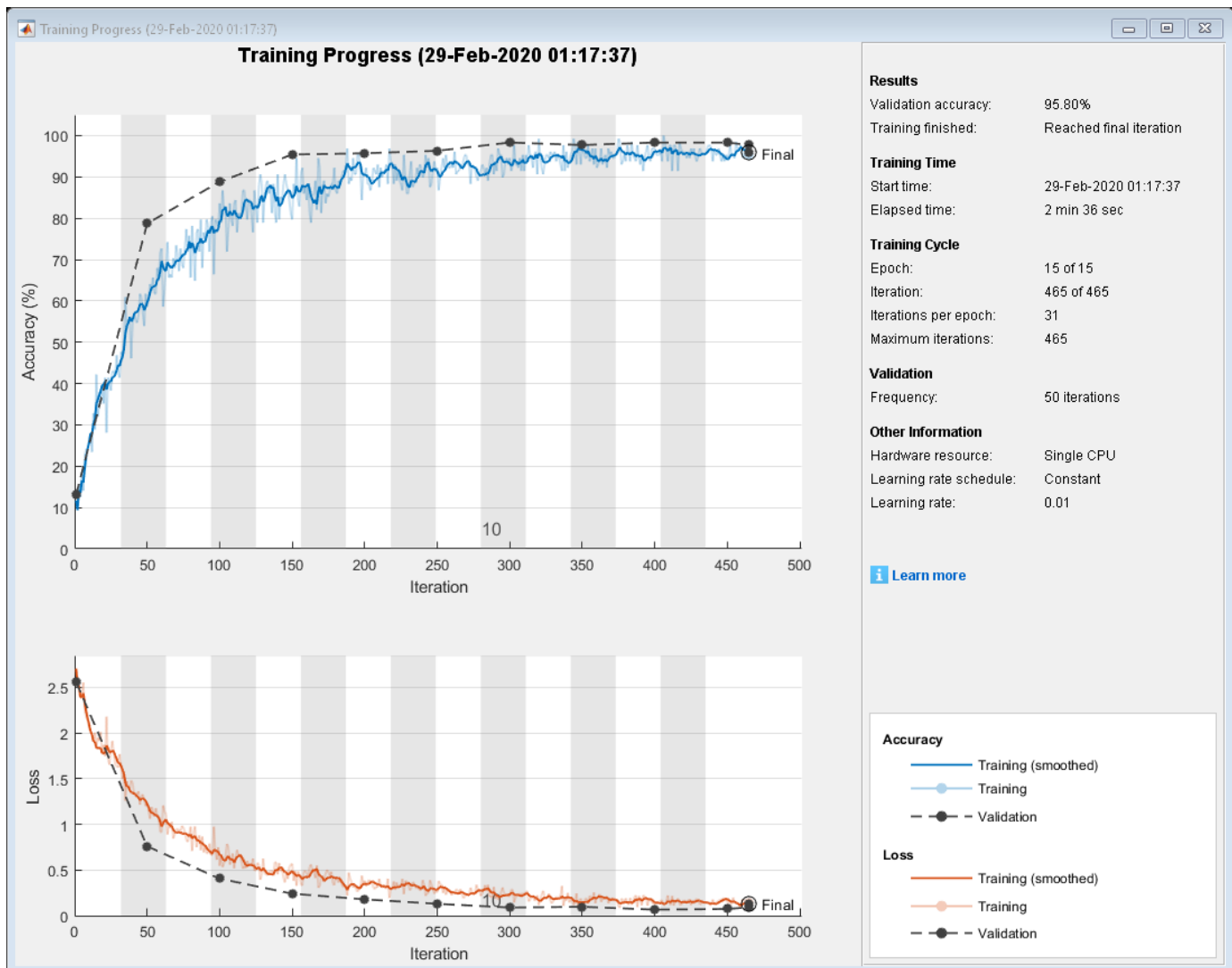

## Tips

- To preview the transformations applied to sample images, use the `augment` function.
- To perform image augmentation during training, create an `augmentedImageDatastore` and specify preprocessing options by using the `'DataAugmentation'` name-value pair with an `imageDataAugmenter`. The augmented image datastore automatically applies random transformations to the training data.

## See Also

`augmentedImageDatastore` | `imageInputLayer` | `trainNetwork`

## Topics

“Deep Learning in MATLAB”

“Preprocess Images for Deep Learning”

“Create Function Handle” (MATLAB)

**Introduced in R2017b**

# image3dInputLayer

3-D image input layer

## Description

A 3-D image input layer inputs 3-D images or volumes to a network and applies data normalization.

For 2-D image input, use `imageInputLayer`.

## Creation

### Syntax

```
layer = image3dInputLayer(inputSize)
layer = image3dInputLayer(inputSize,Name,Value)
```

### Description

`layer = image3dInputLayer(inputSize)` returns a 3-D image input layer and specifies the `InputSize` property.

`layer = image3dInputLayer(inputSize,Name,Value)` sets the optional properties using name-value pairs. You can specify multiple name-value pairs. Enclose each property name in single quotes.

## Properties

### 3-D Image Input

#### InputSize — Size of the input

row vector of integers

Size of the input data, specified as a row vector of integers `[h w d c]`, where `h`, `w`, `d`, and `c` correspond to the height, width, depth, and number of channels respectively.

- For grayscale input, specify a vector with `c` equal to 1.
- For RGB input, specify a vector with `c` equal to 3.
- For multispectral or hyperspectral input, specify a vector with `c` equal to the number of channels.

For 2-D image input, use `imageInputLayer`.

Example: `[132 132 116 3]`

#### Normalization — Data normalization

'zerocenter' (default) | 'zscore' | 'rescale-symmetric' | 'rescale-zero-one' | 'none' | function handle

Data normalization to apply every time data is forward propagated through the input layer, specified as one of the following:

- 'zerocenter' — Subtract the mean specified by `Mean`.
- 'zscore' — Subtract the mean specified by `Mean` and divide by `StandardDeviation`.
- 'rescale-symmetric' — Rescale the input to be in the range [-1, 1] using the minimum and maximum values specified by `Min` and `Max`, respectively.
- 'rescale-zero-one' — Rescale the input to be in the range [0, 1] using the minimum and maximum values specified by `Min` and `Max`, respectively.
- 'none' — Do not normalize the input data.
- function handle — Normalize the data using the specified function. The function must be of the form  $Y = \text{func}(X)$ , where  $X$  is the input data, and the output  $Y$  is the normalized data.

---

**Tip** The software, by default, automatically calculates the normalization statistics at training time. To save time when training, specify the required statistics for normalization and set the 'ResetInputNormalization' option in `trainingOptions` to `false`.

---

### **NormalizationDimension — Normalization dimension**

'auto' (default) | 'channel' | 'element' | 'all'

Normalization dimension, specified as one of the following:

- 'auto' - If the training option is `false` and you specify any of the normalization statistics (`Mean`, `StandardDeviation`, `Min`, or `Max`), then normalize over the dimensions matching the statistics. Otherwise, recalculate the statistics at training time and apply channel-wise normalization.
- 'channel' - Channel-wise normalization.
- 'element' - Element-wise normalization.
- 'all' - Normalize all values using scalar statistics.

### **Mean — Mean for zero-center and z-score normalization**

[] (default) | 4-D array | numeric scalar

Mean for zero-center and z-score normalization, specified as a  $h$ -by- $w$ -by- $d$ -by- $c$  array, a 1-by-1-by-1-by- $c$  array of means per channel, a numeric scalar, or [], where  $h$ ,  $w$ ,  $d$ , and  $c$  correspond to the height, width, depth, and the number of channels of the mean, respectively.

If you specify the `Mean` property, then `Normalization` must be 'zerocenter' or 'zscore'. If `Mean` is [], then the software calculates the mean at training time.

You can set this property when creating networks without training (for example, when assembling networks using `assembleNetwork`).

Data Types: `single` | `double` | `int8` | `int16` | `int32` | `int64` | `uint8` | `uint16` | `uint32` | `uint64`

### **StandardDeviation — Standard deviation for z-score normalization**

[] (default) | 4-D array | numeric scalar

Standard deviation for z-score normalization, specified as a  $h$ -by- $w$ -by- $d$ -by- $c$  array, a 1-by-1-by-1-by- $c$  array of means per channel, a numeric scalar, or [], where  $h$ ,  $w$ ,  $d$ , and  $c$  correspond to the height, width, depth, and the number of channels of the standard deviation, respectively.

If you specify the `StandardDeviation` property, then `Normalization` must be `'zscore'`. If `StandardDeviation` is `[]`, then the software calculates the standard deviation at training time.

You can set this property when creating networks without training (for example, when assembling networks using `assembleNetwork`).

Data Types: `single` | `double` | `int8` | `int16` | `int32` | `int64` | `uint8` | `uint16` | `uint32` | `uint64`

### **Min — Minimum value for rescaling**

`[]` (default) | 4-D array | numeric scalar

Minimum value for rescaling, specified as a *h*-by-*w*-by-*d*-by-*c* array, a 1-by-1-by-1-by-*c* array of minima per channel, a numeric scalar, or `[]`, where *h*, *w*, *d*, and *c* correspond to the height, width, depth, and the number of channels of the minima, respectively.

If you specify the `Min` property, then `Normalization` must be `'rescale-symmetric'` or `'rescale-zero-one'`. If `Min` is `[]`, then the software calculates the minimum at training time.

You can set this property when creating networks without training (for example, when assembling networks using `assembleNetwork`).

Data Types: `single` | `double` | `int8` | `int16` | `int32` | `int64` | `uint8` | `uint16` | `uint32` | `uint64`

### **Max — Maximum value for rescaling**

`[]` (default) | 4-D array | numeric scalar

Maximum value for rescaling, specified as a *h*-by-*w*-by-*d*-by-*c* array, a 1-by-1-by-1-by-*c* array of maxima per channel, a numeric scalar, or `[]`, where *h*, *w*, *d*, and *c* correspond to the height, width, depth, and the number of channels of the maxima, respectively.

If you specify the `Min` property, then `Normalization` must be `'rescale-symmetric'` or `'rescale-zero-one'`. If `Max` is `[]`, then the software calculates the maximum at training time.

You can set this property when creating networks without training (for example, when assembling networks using `assembleNetwork`).

Data Types: `single` | `double` | `int8` | `int16` | `int32` | `int64` | `uint8` | `uint16` | `uint32` | `uint64`

## **Layer**

### **Name — Layer name**

`' '` (default) | character vector | string scalar

Layer name, specified as a character vector or a string scalar. To include a layer in a layer graph, you must specify a nonempty unique layer name. If you train a series network with the layer and `Name` is set to `' '`, then the software automatically assigns a name to the layer at training time.

Data Types: `char` | `string`

### **NumInputs — Number of inputs**

0 (default)

Number of inputs of the layer. The layer has no inputs.

Data Types: `double`

### **InputNames — Input names**

`{}` (default)

Input names of the layer. The layer has no inputs.

Data Types: cell

### **NumOutputs — Number of outputs**

1 (default)

Number of outputs of the layer. This layer has a single output only.

Data Types: double

### **OutputNames — Output names**

{'out'} (default)

Output names of the layer. This layer has a single output only.

Data Types: cell

## **Examples**

### **Create 3-D Image Input Layer**

Create a 3-D image input layer for 132-by-132-by-116 color 3-D images with name 'input'. By default, the layer performs data normalization by subtracting the mean image of the training set from every input image.

```
layer = image3dInputLayer([132 132 116], 'Name', 'input')
```

```
layer =  
  Image3DInputLayer with properties:  
  
          Name: 'input'  
      InputSize: [132 132 116 1]  
  
Hyperparameters  
      Normalization: 'zerocenter'  
NormalizationDimension: 'auto'  
          Mean: []
```

Include a 3-D image input layer in a Layer array.

```
layers = [  
  image3dInputLayer([28 28 28 3])  
  convolution3dLayer(5,16, 'Stride',4)  
  reluLayer  
  maxPooling3dLayer(2, 'Stride',4)  
  fullyConnectedLayer(10)  
  softmaxLayer  
  classificationLayer]  
  
layers =  
  7x1 Layer array with layers:  
  
  1  ''  3-D Image Input      28x28x28x3 images with 'zerocenter' normalization  
  2  ''  Convolution          16 5x5x5 convolutions with stride [4 4 4] and padding [0  
  3  ''  ReLU                  ReLU
```



```

4 '' 3-D Max Pooling      2x2x2 max pooling with stride [4 4 4] and padding [0 0
5 '' Fully Connected    10 fully connected layer
6 '' Softmax            softmax
7 '' Classification Output crossentropyex

```

## Compatibility Considerations

### AverageImage property will be removed

*Not recommended starting in R2019b*

AverageImage will be removed. Use Mean instead. To update your code, replace all instances of AverageImage with Mean. There are no differences between the properties that require additional updates to your code.

### imageInputLayer and image3dInputLayer, by default, use channel-wise normalization

*Behavior change in future release*

Starting in R2019b, imageInputLayer and image3dInputLayer, by default, use channel-wise normalization. In previous versions, these layers use element-wise normalization. To reproduce this behavior, set the NormalizationDimension option of these layers to 'element'.

## See Also

averagePooling3dLayer | convolution3dLayer | fullyConnectedLayer | imageInputLayer  
| maxPooling3dLayer | trainNetwork | transposedConv3dLayer

## Topics

“3-D Brain Tumor Segmentation Using Deep Learning”  
“Deep Learning in MATLAB”  
“Specify Layers of Convolutional Neural Network”  
“List of Deep Learning Layers”

## Introduced in R2019a

# imageInputLayer

Image input layer

## Description

An image input layer inputs 2-D images to a network and applies data normalization.

For 3-D image input, use `image3dInputLayer`.

## Creation

### Syntax

```
layer = imageInputLayer(inputSize)
layer = imageInputLayer(inputSize,Name,Value)
```

### Description

`layer = imageInputLayer(inputSize)` returns an image input layer and specifies the `InputSize` property.

`layer = imageInputLayer(inputSize,Name,Value)` sets the optional properties on page 1-464 using name-value pairs. You can specify multiple name-value pairs. Enclose each property name in single quotes.

## Properties

### Image Input

#### InputSize — Size of the input

row vector of integers

Size of the input data, specified as a row vector of integers `[h w c]`, where `h`, `w`, and `c` correspond to the height, width, and number of channels respectively.

- For grayscale images, specify a vector with `c` equal to 1.
- For RGB images, specify a vector with `c` equal to 3.
- For multispectral or hyperspectral images, specify a vector with `c` equal to the number of channels.

For 3-D image or volume input, use `image3dInputLayer`.

Example: `[224 224 3]`

#### Normalization — Data normalization

'zerocenter' (default) | 'zscore' | 'rescale-symmetric' | 'rescale-zero-one' | 'none' | function handle

Data normalization to apply every time data is forward propagated through the input layer, specified as one of the following:

- 'zerocenter' — Subtract the mean specified by `Mean`.
- 'zscore' — Subtract the mean specified by `Mean` and divide by `StandardDeviation`.
- 'rescale-symmetric' — Rescale the input to be in the range [-1, 1] using the minimum and maximum values specified by `Min` and `Max`, respectively.
- 'rescale-zero-one' — Rescale the input to be in the range [0, 1] using the minimum and maximum values specified by `Min` and `Max`, respectively.
- 'none' — Do not normalize the input data.
- function handle — Normalize the data using the specified function. The function must be of the form  $Y = \text{func}(X)$ , where  $X$  is the input data, and the output  $Y$  is the normalized data.

---

**Tip** The software, by default, automatically calculates the normalization statistics at training time. To save time when training, specify the required statistics for normalization and set the 'ResetInputNormalization' option in `trainingOptions` to `false`.

---

### NormalizationDimension — Normalization dimension

'auto' (default) | 'channel' | 'element' | 'all'

Normalization dimension, specified as one of the following:

- 'auto' - If the training option is `false` and you specify any of the normalization statistics (`Mean`, `StandardDeviation`, `Min`, or `Max`), then normalize over the dimensions matching the statistics. Otherwise, recalculate the statistics at training time and apply channel-wise normalization.
- 'channel' - Channel-wise normalization.
- 'element' - Element-wise normalization.
- 'all' - Normalize all values using scalar statistics.

### Mean — Mean for zero-center and z-score normalization

[] (default) | 3-D array | numeric scalar

Mean for zero-center and z-score normalization, specified as a  $h$ -by- $w$ -by- $c$  array, a 1-by-1-by- $c$  array of means per channel, a numeric scalar, or [], where  $h$ ,  $w$ , and  $c$  correspond to the height, width, and the number of channels of the mean, respectively.

If you specify the `Mean` property, then `Normalization` must be 'zerocenter' or 'zscore'. If `Mean` is [], then the software calculates the mean at training time.

You can set this property when creating networks without training (for example, when assembling networks using `assembleNetwork`).

Data Types: `single` | `double` | `int8` | `int16` | `int32` | `int64` | `uint8` | `uint16` | `uint32` | `uint64`

### StandardDeviation — Standard deviation for z-score normalization

[] (default) | 3-D array | numeric scalar

Standard deviation for z-score normalization, specified as a  $h$ -by- $w$ -by- $c$  array, a 1-by-1-by- $c$  array of means per channel, a numeric scalar, or [], where  $h$ ,  $w$ , and  $c$  correspond to the height, width, and the number of channels of the standard deviation, respectively.

If you specify the `StandardDeviation` property, then `Normalization` must be `'zscore'`. If `StandardDeviation` is `[]`, then the software calculates the standard deviation at training time.

You can set this property when creating networks without training (for example, when assembling networks using `assembleNetwork`).

Data Types: `single` | `double` | `int8` | `int16` | `int32` | `int64` | `uint8` | `uint16` | `uint32` | `uint64`

### **Min — Minimum value for rescaling**

`[]` (default) | 3-D array | numeric scalar

Minimum value for rescaling, specified as a *h*-by-*w*-by-*c* array, a 1-by-1-by-*c* array of minima per channel, a numeric scalar, or `[]`, where *h*, *w*, and *c* correspond to the height, width, and the number of channels of the minima, respectively.

If you specify the `Min` property, then `Normalization` must be `'rescale-symmetric'` or `'rescale-zero-one'`. If `Min` is `[]`, then the software calculates the minimum at training time.

You can set this property when creating networks without training (for example, when assembling networks using `assembleNetwork`).

Data Types: `single` | `double` | `int8` | `int16` | `int32` | `int64` | `uint8` | `uint16` | `uint32` | `uint64`

### **Max — Maximum value for rescaling**

`[]` (default) | 3-D array | numeric scalar

Maximum value for rescaling, specified as a *h*-by-*w*-by-*c* array, a 1-by-1-by-*c* array of maxima per channel, a numeric scalar, or `[]`, where *h*, *w*, and *c* correspond to the height, width, and the number of channels of the maxima, respectively.

If you specify the `Max` property, then `Normalization` must be `'rescale-symmetric'` or `'rescale-zero-one'`. If `Max` is `[]`, then the software calculates the maximum at training time.

You can set this property when creating networks without training (for example, when assembling networks using `assembleNetwork`).

Data Types: `single` | `double` | `int8` | `int16` | `int32` | `int64` | `uint8` | `uint16` | `uint32` | `uint64`

### **DataAugmentation — Data augmentation transforms**

`'none'` (default) | `'randcrop'` | `'randfliplr'` | cell array of `'randcrop'` and `'randfliplr'`

---

**Note** The `DataAugmentation` property is not recommended. To preprocess images with cropping, reflection, and other geometric transformations, use `augmentedImageDatastore` instead.

---

Data augmentation transforms to use during training, specified as one of the following.

- `'none'` — No data augmentation
- `'randcrop'` — Take a random crop from the training image. The random crop has the same size as the input size.
- `'randfliplr'` — Randomly flip the input images horizontally with a 50% chance.
- Cell array of `'randcrop'` and `'randfliplr'`. The software applies the augmentation in the order specified in the cell array.

Augmentation of image data is another way of reducing overfitting [1], [2].

Data Types: `string` | `char` | `cell`

## Layer

### Name — Layer name

`''` (default) | character vector | string scalar

Layer name, specified as a character vector or a string scalar. To include a layer in a layer graph, you must specify a nonempty unique layer name. If you train a series network with the layer and Name is set to `''`, then the software automatically assigns a name to the layer at training time.

Data Types: `char` | `string`

### NumInputs — Number of inputs

0 (default)

Number of inputs of the layer. The layer has no inputs.

Data Types: `double`

### InputNames — Input names

`{}` (default)

Input names of the layer. The layer has no inputs.

Data Types: `cell`

### NumOutputs — Number of outputs

1 (default)

Number of outputs of the layer. This layer has a single output only.

Data Types: `double`

### OutputNames — Output names

`{'out'}` (default)

Output names of the layer. This layer has a single output only.

Data Types: `cell`

## Examples

### Create Image Input Layer

Create an image input layer for 28-by-28 color images with name `'input'`. By default, the layer performs data normalization by subtracting the mean image of the training set from every input image.

```
inputlayer = imageInputLayer([28 28 3], 'Name', 'input')
```

```
inputlayer =
  ImageInputLayer with properties:
      Name: 'input'
  InputSize: [28 28 3]
```

```
Hyperparameters
  DataAugmentation: 'none'
  Normalization: 'zerocenter'
  NormalizationDimension: 'auto'
  Mean: []
```

Include an image input layer in a `Layer` array.

```
layers = [ ...
  imageInputLayer([28 28 1])
  convolution2dLayer(5,20)
  reluLayer
  maxPooling2dLayer(2, 'Stride',2)
  fullyConnectedLayer(10)
  softmaxLayer
  classificationLayer]
```

```
layers =
  7x1 Layer array with layers:
```

1	''	Image Input	28x28x1 images with 'zerocenter' normalization
2	''	Convolution	20 5x5 convolutions with stride [1 1] and padding [0 0 0 0]
3	''	ReLU	ReLU
4	''	Max Pooling	2x2 max pooling with stride [2 2] and padding [0 0 0 0]
5	''	Fully Connected	10 fully connected layer
6	''	Softmax	softmax
7	''	Classification Output	crossentropyex

## Compatibility Considerations

### AverageImage property will be removed

*Not recommended starting in R2019b*

`AverageImage` will be removed. Use `Mean` instead. To update your code, replace all instances of `AverageImage` with `Mean`. There are no differences between the properties that require additional updates to your code.

### imageInputLayer and image3dInputLayer, by default, use channel-wise normalization

*Behavior change in future release*

Starting in R2019b, `imageInputLayer` and `image3dInputLayer`, by default, use channel-wise normalization. In previous versions, these layers use element-wise normalization. To reproduce this behavior, set the `NormalizationDimension` option of these layers to `'element'`.

## References

- [1] Krizhevsky, A., I. Sutskever, and G. E. Hinton. "ImageNet Classification with Deep Convolutional Neural Networks". *Advances in Neural Information Processing Systems*. Vol 25, 2012.
- [2] Cireşan, D., U. Meier, J. Schmidhuber. "Multi-column Deep Neural Networks for Image Classification". *IEEE Conference on Computer Vision and Pattern Recognition*, 2012.

## Extended Capabilities

### GPU Code Generation

Generate CUDA® code for NVIDIA® GPUs using GPU Coder™.

### See Also

**Deep Network Designer** | `augmentedImageDatastore` | `convolution2dLayer` | `fullyConnectedLayer` | `image3dInputLayer` | `maxPooling2dLayer` | `trainNetwork`

### Topics

“Create Simple Deep Learning Network for Classification”

“Train Convolutional Neural Network for Regression”

“Deep Learning in MATLAB”

“Specify Layers of Convolutional Neural Network”

“List of Deep Learning Layers”

### Introduced in R2016a

## importCaffeLayers

Import convolutional neural network layers from Caffe

### Syntax

```
layers = importCaffeLayers(protofile)
layers = importCaffeLayers(protofile, 'InputSize', sz)
```

### Description

`layers = importCaffeLayers(protofile)` imports the layers of a Caffe [1] network. The function returns the layers defined in the `.prototxt` file `protofile`.

This function requires Deep Learning Toolbox Importer *for Caffe Models* support package. If this support package is not installed, then the function provides a download link.

You can download pretrained networks from Caffe Model Zoo [2].

`layers = importCaffeLayers(protofile, 'InputSize', sz)` specifies the size of the input data. If the `.prototxt` file does not specify the size of the input data, then you must specify the input size.

### Examples

#### Download Importer *for Caffe Models* Support Package

Download and install Deep Learning Toolbox Importer *for Caffe Models* support package.

Download the required support package by typing `importCaffeLayers` at the command line.

```
importCaffeLayers
```

If Deep Learning Toolbox Importer *for Caffe Models* support package is not installed, then the function provides a link to the required support package in the Add-On Explorer. To install the support package, click the link, and then click **Install**.

#### Import Layers from Caffe Network

Specify the example file `'digitsnet.prototxt'` to import.

```
protofile = 'digitsnet.prototxt';
```

Import the network layers.

```
layers = importCaffeLayers(protofile)
```

```
layers =
```

```
    1x7 Layer array with layers:
```



```

1 'testdata' Image Input      28x28x1 images
2 'conv1'   Convolution    20 5x5x1 convolutions with stride [1 1] and padding [0 0]
3 'relu1'   ReLU           ReLU
4 'pool1'   Max Pooling    2x2 max pooling with stride [2 2] and padding [0 0]
5 'ipl'     Fully Connected    10 fully connected layer
6 'loss'    Softmax           softmax
7 'output'  Classification Output crossentropyex with 'class1', 'class2', and 8 other classes

```

## Input Arguments

### protofile — File name

character vector | string scalar

File name of the `.prototxt` file containing the network architecture, specified as a character vector or a string scalar. `protofile` must be in the current folder, in a folder on the MATLAB path, or you must include a full or relative path to the file. If the `.prototxt` file does not specify the size of the input data, you must specify the size using the `sz` input argument.

Example: `'digitsnet.prototxt'`

### sz — Size of input data

row vector

Size of input data, specified as a row vector. Specify a vector of two or three integer values `[h,w]`, or `[h,w,c]` corresponding to the height, width, and the number of channels of the input data.

Example: `[28 28 1]`

## Output Arguments

### layers — Network architecture

Layer array | LayerGraph object

Network architecture, returned as a `Layer` array or a `LayerGraph` object. Caffe networks that take color images as input expect the images to be in BGR format. During import, `importCaffeLayers` modifies the network so that the imported MATLAB network takes RGB images as input.

## Tips

- `importCaffeLayers` can import networks with the following Caffe layer types, with some limitations:

Caffe Layer	Deep Learning Toolbox Layer
BatchNormLayer	batchNormalizationLayer
ConcatLayer	depthConcatenationLayer
ConvolutionLayer	convolution2dLayer
DeconvolutionLayer	transposedConv2dLayer
DropoutLayer	dropoutLayer
EltwiseLayer (only sum)	additionLayer
EuclideanLossLayer	RegressionOutputLayer
InnerProductLayer	fullyConnectedLayer

<b>Caffe Layer</b>	<b>Deep Learning Toolbox Layer</b>
InputLayer	imageInputLayer
LRNLayer (Local Response Normalization)	crossChannelNormalizationLayer
PoolingLayer	maxPooling2dLayer or averagePooling2dLayer
ReLULayer	reluLayer or leakyReluLayer
ScaleLayer	batchNormalizationLayer
SigmoidLayer	nnet.caffe.layer.SigmoidLayer
SoftmaxLayer	softmaxLayer
TanHLayer	tanhLayer

If the network contains any other type of layer, then the software returns an error.

The function imports only the layers that `profile` specifies with the include-phase TEST. The function ignores any layers that `profile` specifies with the include-phase TRAIN.

## References

[1] *Caffe*. <https://caffe.berkeleyvision.org/>.

[2] *Caffe Model Zoo*. [https://caffe.berkeleyvision.org/model\\_zoo.html](https://caffe.berkeleyvision.org/model_zoo.html).

## See Also

`assembleNetwork` | `exportONNXNetwork` | `importCaffeNetwork` | `importKerasLayers` | `importKerasNetwork` | `importONNXLayers` | `importONNXNetwork`

## Topics

“Deep Learning in MATLAB”

“Pretrained Deep Neural Networks”

“List of Deep Learning Layers”

## Introduced in R2017a

# importCaffeNetwork

Import pretrained convolutional neural network models from Caffe

## Syntax

```
net = importCaffeNetwork(protofile,datafile)
net = importCaffeNetwork( ____,Name,Value)
```

## Description

`net = importCaffeNetwork(protofile,datafile)` imports a pretrained network from Caffe [1]. The function returns the pretrained network with the architecture specified by the `.prototxt` file `protofile` and with network weights specified by the `.caffemodel` file `datafile`.

This function requires Deep Learning Toolbox Importer *for Caffe Models* support package. If this support package is not installed, the function provides a download link.

You can download pretrained networks from Caffe Model Zoo [2].

`net = importCaffeNetwork( ____,Name,Value)` returns a network with additional options specified by one or more `Name,Value` pair arguments using any of the previous syntaxes.

## Examples

### Download Importer *for Caffe Models* Support Package

Download and install Deep Learning Toolbox Importer *for Caffe Models* support package.

To download the required support package, type `importCaffeNetwork` at the command line.

```
importCaffeNetwork
```

If Deep Learning Toolbox Importer *for Caffe Models* support package is not installed, then the function provides a link to the required support package in the Add-On Explorer. To install the support package, click the link, and then click **Install**.

### Import Caffe Network

Specify files to import.

```
protofile = 'digitsnet.prototxt';
datafile = 'digits_iter_10000.caffemodel';
```

Import network.

```
net = importCaffeNetwork(protofile,datafile)
```

```
net =
    SeriesNetwork with properties:
```

Layers: [7×1 nnet.cnn.layer.Layer]

## Input Arguments

### **protofile** — File name

character vector | string scalar

File name of the `.prototxt` file containing the network architecture, specified as a character vector or a string scalar. `protofile` must be in the current folder, in a folder on the MATLAB path, or you must include a full or relative path to the file. If the `.prototxt` file does not specify the size of the input data, you must specify the size using the `'InputSize'` name-value pair argument.

Example: `'digitsnet.prototxt'`

### **datafile** — File name

character vector | string scalar

File name of the `.caffemodel` file containing the network weights, specified as a character vector or a string scalar. `datafile` must be in the current folder, in a folder on the MATLAB path, or you must include a full or relative path to the file. To import network layers without weights, use `importCaffeLayers`.

Example: `'digits_iter_10000.caffemodel'`

## Name-Value Pair Arguments

Specify optional comma-separated pairs of `Name, Value` arguments. `Name` is the argument name and `Value` is the corresponding value. `Name` must appear inside quotes. You can specify several name and value pair arguments in any order as `Name1, Value1, ..., NameN, ValueN`.

Example: `importCaffeNetwork(protofile,datafile,'AverageImage',I)` imports a pretrained network using the average image `I` for zero-center normalization.

### **InputSize** — Size of input data

row vector

Size of input data, specified as a row vector. Specify a vector of two or three integer values `[h,w]`, or `[h,w,c]` corresponding to the height, width, and the number of channels of the input data. If the `.prototxt` file does not specify the size of the input data, then you must specify the input size.

Example: `[28 28 1]`

### **AverageImage** — Average image

matrix

Average image for zero-center normalization, specified as a matrix. If you specify an image, then you must specify an image of the same size as the input data. If you do not specify an image, the software uses the data specified in the `.prototxt` file, if present. Otherwise, the function sets the `Normalization` property of the image input layer of the network to `'none'`.

### **Classes** — Classes of the output layer

`'auto'` (default) | categorical vector | string array | cell array of character vectors

Classes of the output layer, specified as a categorical vector, string array, cell array of character vectors, or 'auto'. If you specify a string array or cell array of character vectors `str`, then the software sets the classes of the output layer to `categorical(str, str)`. If `Classes` is 'auto', then the function sets the classes to `categorical(1:N)`, where `N` is the number of classes.

Data Types: `char` | `categorical` | `string` | `cell`

## Output Arguments

### **net** — Imported pretrained Caffe network

SeriesNetwork object | DAGNetwork object

Imported pretrained Caffe network, returned as a SeriesNetwork object or DAGNetwork object. Caffe networks that take color images as input expect the images to be in BGR format. During import, `importCaffeNetwork` modifies the network so that the imported MATLAB network takes RGB images as input.

## Tips

- `importCaffeNetwork` can import networks with the following Caffe layer types, with some limitations:

Caffe Layer	Deep Learning Toolbox Layer
BatchNormLayer	batchNormalizationLayer
ConcatLayer	depthConcatenationLayer
ConvolutionLayer	convolution2dLayer
DeconvolutionLayer	transposedConv2dLayer
DropoutLayer	dropoutLayer
EltwiseLayer (only sum)	additionLayer
EuclideanLossLayer	RegressionOutputLayer
InnerProductLayer	fullyConnectedLayer
InputLayer	imageInputLayer
LRNLayer (Local Response Normalization)	crossChannelNormalizationLayer
PoolingLayer	maxPooling2dLayer or averagePooling2dLayer
ReLULayer	reluLayer or leakyReluLayer
ScaleLayer	batchNormalizationLayer
SigmoidLayer	nnet.caffe.layer.SigmoidLayer
SoftmaxLayer	softmaxLayer
TanHLayer	tanhLayer

If the network contains any other type of layer, then the software returns an error.

The function imports only the layers that `protofile` specifies with the include-phase TEST. The function ignores any layers that `protofile` specifies with the include-phase TRAIN.

## Compatibility Considerations

### 'ClassNames' option will be removed

*Not recommended starting in R2018b*

'ClassNames' will be removed. Use 'Classes' instead. To update your code, replace all instances of 'ClassNames' with 'Classes'. There are some differences between the corresponding properties in classification output layers that require additional updates to your code.

The `ClassNames` property of a classification output layer is a cell array of character vectors. The `Classes` property is a categorical array. To use the value of `Classes` with functions that require cell array input, convert the classes using the `cellstr` function.

## References

[1] *Caffe*. <https://caffe.berkeleyvision.org/>.

[2] *Caffe Model Zoo*. [https://caffe.berkeleyvision.org/model\\_zoo.html](https://caffe.berkeleyvision.org/model_zoo.html).

## Extended Capabilities

### GPU Code Generation

Generate CUDA® code for NVIDIA® GPUs using GPU Coder™.

Usage notes and limitations:

For code generation, you can load the network by using the syntax `net = importCaffeNetwork`.

### See Also

`assembleNetwork` | `exportONNXNetwork` | `importCaffeLayers` | `importKerasLayers` | `importKerasNetwork` | `importONNXLayers` | `importONNXNetwork`

### Topics

“Deep Learning in MATLAB”

“Pretrained Deep Neural Networks”

### Introduced in R2017a

# importKerasLayers

Import layers from Keras network

## Syntax

```
layers = importKerasLayers(modelfile)
layers = importKerasLayers(modelfile,Name,Value)
```

## Description

`layers = importKerasLayers(modelfile)` imports the layers of a TensorFlow-Keras network from a model file. The function returns the layers defined in the HDF5 (.h5) or JSON (.json) file given by the file name `modelfile`.

This function requires the Deep Learning Toolbox Importer *for TensorFlow-Keras Models* support package. If this support package is not installed, then the function provides a download link.

`layers = importKerasLayers(modelfile,Name,Value)` imports the layers from a TensorFlow-Keras network with additional options specified by one or more name-value pair arguments.

For example, `importKerasLayers(modelfile,'ImportWeights',true)` imports the network layers and the weights from the model file `modelfile`.

## Examples

### Download and Install Deep Learning Toolbox Importer for TensorFlow-Keras Models Support Package

Download and install Deep Learning Toolbox Importer *for TensorFlow-Keras Models* support package.

Type `importKerasLayers` at the command line.

```
importKerasLayers
```

If Deep Learning Toolbox Importer *for TensorFlow-Keras Models* support package is not installed, then the function provides a link to the required support package in the Add-On Explorer. To install the support package, click the link, and then click **Install**. Check that the installation is successful by importing the layers from the model file `'digitsDAGnet.h5'` at the command line.

```
modelfile = 'digitsDAGnet.h5';
layers = importKerasLayers(modelfile)
```

```
layers =
```

```
LayerGraph with properties:
```

```
Layers: [13x1 nnet.cnn.layer.Layer]
Connections: [13x2 table]
```

If the required support package is installed, then the function returns a LayerGraph object.

### Import Layers from Keras Network and Plot Architecture

Import the network layers from the model file `digitsDAGnet.h5`.

```
modelfile = 'digitsDAGnet.h5';
layers = importKerasLayers(modelfile)

layers =
  LayerGraph with properties:
    Layers: [13x1 nnet.cnn.layer.Layer]
    Connections: [13x2 table]
```

Plot the network architecture.

```
figure
plot(layers)
```

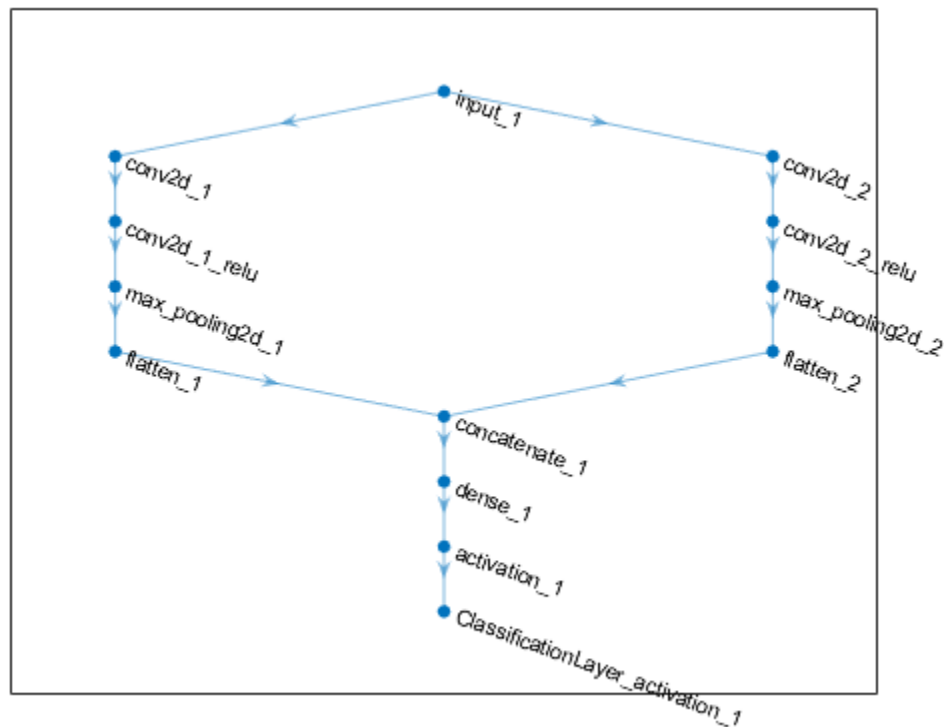

### Import Keras Network Layers and Train Network

Specify the network file to import.



```
modelfile = 'digitsDAGnet.h5';
```

Import network layers.

```
layers = importKerasLayers(modelfile)
```

```
layers =
  LayerGraph with properties:
      Layers: [13x1 nnet.cnn.layer.Layer]
  Connections: [13x2 table]
```

Load a data set for training a classifier to recognize new digits.

```
folder = fullfile(toolboxdir('nnet'),'nndemos','nndatasets','DigitDataset');
imds = imageDatastore(folder, ...
    'IncludeSubfolders',true, ...
    'LabelSource','foldernames');
```

Partition the dataset into training and test sets.

```
numTrainFiles = 750;
[imdsTrain,imdsTest] = splitEachLabel(imds,numTrainFiles,'randomize');
```

Set the training options.

```
options = trainingOptions('sgdm', ...
    'MaxEpochs',10, ...
    'InitialLearnRate',0.001);
```

Train network using training data.

```
net = trainNetwork(imdsTrain,layers,options);
```

Training on single GPU.

Epoch	Iteration	Time Elapsed (hh:mm:ss)	Mini-batch Accuracy	Mini-batch Loss	Base Learning Rate
1	1	00:00:00	5.47%	6.4266	0.0010
1	50	00:00:05	81.25%	0.6227	0.0010
2	100	00:00:08	92.19%	0.2386	0.0010
3	150	00:00:12	96.88%	0.0726	0.0010
4	200	00:00:16	97.66%	0.0871	0.0010
5	250	00:00:19	99.22%	0.0415	0.0010
6	300	00:00:23	97.66%	0.0725	0.0010
7	350	00:00:27	100.00%	0.0291	0.0010
7	400	00:00:30	99.22%	0.0230	0.0010
8	450	00:00:34	99.22%	0.0337	0.0010
9	500	00:00:38	99.22%	0.0120	0.0010
10	550	00:00:41	100.00%	0.0036	0.0010
10	580	00:00:44	100.00%	0.0059	0.0010

Run the trained network on the test set that was not used to train the network and predict the image labels (digits).

```
YPred = classify(net,imdsTest);
YTest = imdsTest.Labels;
```

Calculate the accuracy.

```
accuracy = sum(YPred == YTest)/numel(YTest)
accuracy = 0.9828
```

### Import Keras Network Architecture and Weights from Same File

Specify the network file to import layers and weights from.

```
modelfile = 'digitsDAGnet.h5';
```

Import the network architecture and weights from the files you specified. To import the layer weights, specify 'ImportWeights' to be true. The function also imports the layers with their weights from the same HDF5 file.

```
layers = importKerasLayers(modelfile, 'ImportWeights', true)
```

```
layers =
  LayerGraph with properties:
      Layers: [13x1 nnet.cnn.layer.Layer]
      Connections: [13x2 table]
```

View the size of the weights in the second layer.

```
weights = layers.Layers(2).Weights;
size(weights)
```

```
ans = 1x4
      7      7      1     20
```

The function has imported the weights so the layer weights are non-empty.

### Import Keras Network Architecture and Weights from Separate Files

Specify the network file to import layers from and the file containing weights.

```
modelfile = 'digitsDAGnet.json';
weights = 'digitsDAGnet.weights.h5';
```

Import the network architecture and weights from the files you specified. The .json file does not include an output layer. Specify the output layer, so that importKerasLayers adds an output layer at the end of the networks architecture.

```
layers = importKerasLayers(modelfile, ...
    'ImportWeights', true, ...
    'WeightFile', weights, ...
    'OutputLayerType', 'classification')
```

```
layers =  
  LayerGraph with properties:  
  
    Layers: [13×1 nnet.cnn.layer.Layer]  
    Connections: [13×2 table]
```

## Assemble Network from Pretrained Keras Layers

This example shows how to import the layers from a pretrained Keras network, replace the unsupported layers with custom layers, and assemble the layers into a network ready for prediction.

### Import Keras Network

Import the layers from a Keras network model. The network in 'digitsDAGnetwithnoise.h5' classifies images of digits.

```
filename = 'digitsDAGnetwithnoise.h5';  
lgraph = importKerasLayers(filename, 'ImportWeights', true);
```

Warning: Unable to import some Keras layers, because they are not yet supported by the Deep Learning Toolbox.

The Keras network contains some layers that are not supported by Deep Learning Toolbox. The `importKerasLayers` function displays a warning and replaces the unsupported layers with placeholder layers.

Plot the layer graph using `plot`.

```
figure  
plot(lgraph)  
title("Imported Network")
```

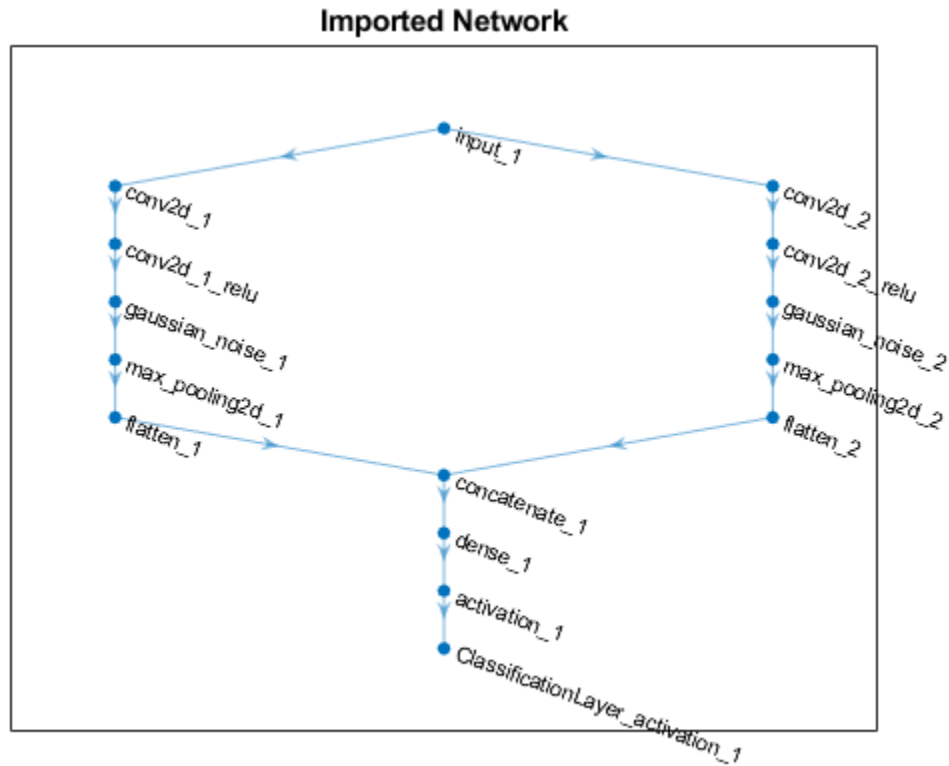

### Replace Placeholder Layers

To replace the placeholder layers, first identify the names of the layers to replace. Find the placeholder layers using `findPlaceholderLayers`.

```
placeholderLayers = findPlaceholderLayers(lgraph)
```

```
placeholderLayers =  
  2x1 PlaceholderLayer array with layers:
```

1	'gaussian_noise_1'	PLACEHOLDER LAYER	Placeholder for 'GaussianNoise' Keras layer
2	'gaussian_noise_2'	PLACEHOLDER LAYER	Placeholder for 'GaussianNoise' Keras layer

Display the Keras configurations of these layers.

```
placeholderLayers.KerasConfiguration
```

```
ans = struct with fields:  
  trainable: 1  
  name: 'gaussian_noise_1'  
  stddev: 1.5000
```

```
ans = struct with fields:  
  trainable: 1  
  name: 'gaussian_noise_2'  
  stddev: 0.7000
```

Define a custom Gaussian noise layer. To create this layer, save the file `gaussianNoiseLayer.m` in the current folder. Then, create two Gaussian noise layers with the same configurations as the imported Keras layers.

```
gnLayer1 = gaussianNoiseLayer(1.5, 'new_gaussian_noise_1');
gnLayer2 = gaussianNoiseLayer(0.7, 'new_gaussian_noise_2');
```

Replace the placeholder layers with the custom layers using `replaceLayer`.

```
lgraph = replaceLayer(lgraph, 'gaussian_noise_1', gnLayer1);
lgraph = replaceLayer(lgraph, 'gaussian_noise_2', gnLayer2);
```

Plot the updated layer graph using `plot`.

```
figure
plot(lgraph)
title("Network with Replaced Layers")
```

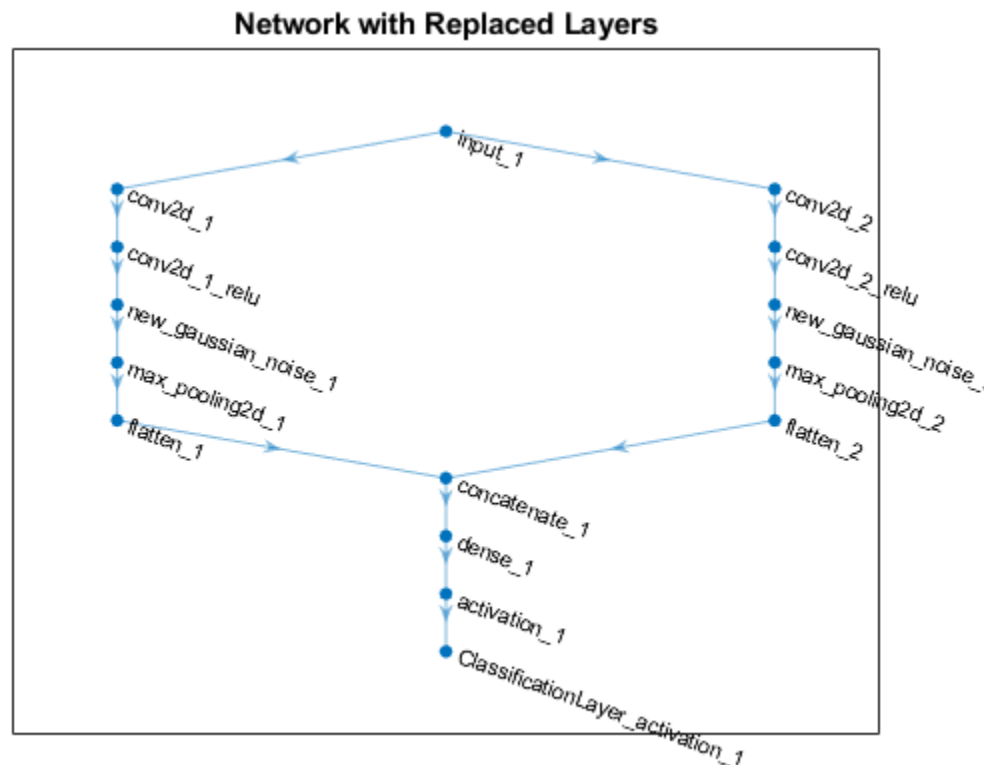

### Specify Class Names

If the imported classification layer does not contain the classes, then you must specify these before prediction. If you do not specify the classes, then the software automatically sets the classes to 1, 2, ..., N, where N is the number of classes.

Find the index of the classification layer by viewing the `Layers` property of the layer graph.

```
lgraph.Layers
```

```
ans =
  15x1 Layer array with layers:

   1  'input_1'           Image Input           28x28x1 images
   2  'conv2d_1'         Convolution           20 7x7x1 convolutions with
   3  'conv2d_1_relu'    ReLU                  ReLU
   4  'conv2d_2'         Convolution           20 3x3x1 convolutions with
   5  'conv2d_2_relu'    ReLU                  ReLU
   6  'new_gaussian_noise_1' Gaussian Noise        Gaussian noise with standar
   7  'new_gaussian_noise_2' Gaussian Noise        Gaussian noise with standar
   8  'max_pooling2d_1'  Max Pooling           2x2 max pooling with strid
   9  'max_pooling2d_2'  Max Pooling           2x2 max pooling with strid
  10  'flatten_1'       Keras Flatten         Flatten activations into 1
  11  'flatten_2'       Keras Flatten         Flatten activations into 1
  12  'concatenate_1'   Depth concatenation    Depth concatenation of 2 in
  13  'dense_1'         Fully Connected       10 fully connected layer
  14  'activation_1'    Softmax               softmax
  15  'ClassificationLayer_activation_1' Classification Output  crossentropyex
```

The classification layer has the name 'ClassificationLayer\_activation\_1'. View the classification layer and check the Classes property.

```
cLayer = lgraph.Layers(end)
```

```
cLayer =
  ClassificationOutputLayer with properties:

      Name: 'ClassificationLayer_activation_1'
      Classes: 'auto'
      OutputSize: 'auto'

  Hyperparameters
      LossFunction: 'crossentropyex'
```

Because the Classes property of the layer is 'auto', you must specify the classes manually. Set the classes to 0, 1, ..., 9, and then replace the imported classification layer with the new one.

```
cLayer.Classes = string(0:9)
```

```
cLayer =
  ClassificationOutputLayer with properties:

      Name: 'ClassificationLayer_activation_1'
      Classes: [0  1  2  3  4  5  6  7  8  9]
      OutputSize: 10

  Hyperparameters
      LossFunction: 'crossentropyex'
```

```
lgraph = replaceLayer(lgraph, 'ClassificationLayer_activation_1', cLayer);
```

### Assemble Network

Assemble the layer graph using `assembleNetwork`. The function returns a `DAGNetwork` object that is ready to use for prediction.

```
net = assembleNetwork(lgraph)
```

```
net =
  DAGNetwork with properties:

      Layers: [15x1 nnet.cnn.layer.Layer]
  Connections: [15x2 table]
  InputNames: {'input_1'}
  OutputNames: {'ClassificationLayer_activation_1'}
```

## Import Keras PReLU Layer

Import layers from a Keras network that has parametric rectified linear unit (PReLU) layers.

A PReLU layer performs a threshold operation, where for each channel, any input value less than zero is multiplied by a scalar. The PReLU operation is given by

$$f(x_i) = \begin{cases} x_i & \text{if } x_i > 0 \\ a_i x_i & \text{if } x_i \leq 0 \end{cases}$$

where  $x_i$  is the input of the nonlinear activation  $f$  on channel  $i$ , and  $a_i$  is the scaling parameter controlling the slope of the negative part. The subscript  $i$  in  $a_i$  indicates that the parameter can be a vector and the nonlinear activation can vary on different channels.

`importKerasNetwork` and `importKerasLayers` can import a network that includes PReLU layers. These functions support both scalar-valued and vector-valued scaling parameters. If a scaling parameter is a vector, then the functions replace the vector with the average of the vector elements. You can modify a PReLU layer to have a vector-valued scaling parameter after import.

Specify the network file to import.

```
modelfile = 'digitsDAGnetwithPReLU.h5';
```

`digitsDAGnetwithPReLU` includes two PReLU layers. One has a scalar-valued scaling parameter, and the other has a vector-valued scaling parameter.

Import the network architecture and weights from `modelfile`.

```
layers = importKerasLayers(modelfile, 'ImportWeights', true);
```

Warning: Layer 'p\_re\_lu\_1' is a PReLU layer with a vector-valued parameter. The function replaces

The `importKerasLayers` function displays a warning for the PReLU layer `p_re_lu_1`. The function replaces the vector-valued scaling parameter of `p_re_lu_1` with the average of the vector elements. You can change the parameter back to a vector. First, find the index of the PReLU layer by viewing the `Layers` property.

```
layers.Layers
```

```
ans =
  13x1 Layer array with layers:

   1  'input_1'           Image Input           28x28x1 images
   2  'conv2d_1'         Convolution           20 7x7x1 convolutions with stri
   3  'conv2d_2'         Convolution           20 3x3x1 convolutions with stri
```

```

4 'p_re_lu_1'          PReLU          PReLU layer
5 'p_re_lu_2'          PReLU          PReLU layer
6 'max_pooling2d_1'    Max Pooling    2x2 max pooling with stride [2
7 'max_pooling2d_2'    Max Pooling    2x2 max pooling with stride [2
8 'flatten_1'          Keras Flatten  Flatten activations into 1-D as
9 'flatten_2'          Keras Flatten  Flatten activations into 1-D as
10 'concatenate_1'     Depth concatenation  Depth concatenation of 2 inputs
11 'dense_1'           Fully Connected  10 fully connected layer
12 'dense_1_softmax'   Softmax         softmax
13 'ClassificationLayer_dense_1'  Classification Output  crossentropy

```

`layers` has two PReLU layers. Extract the fourth layer `p_re_lu_1`, which originally had a vector-valued scaling parameter for a channel dimension.

```

tempLayer = layers.Layers(4)

tempLayer =
  PreluLayer with properties:

    Name: 'p_re_lu_1'
    RawAlpha: [20x1 single]

  Learnable Parameters
    Alpha: 0.0044

  Show all properties

```

The `RawAlpha` property contains the vector-valued scaling parameter, and the `Alpha` property contains a scalar that is an element average of the vector values. Reshape `RawAlpha` to place the vector values in the third dimension, which corresponds to the channel dimension. Then, replace `Alpha` with the reshaped `RawAlpha` values.

```

tempLayer.Alpha = reshape(tempLayer.RawAlpha,[1,1,numel(tempLayer.RawAlpha)])

tempLayer =
  PreluLayer with properties:

    Name: 'p_re_lu_1'
    RawAlpha: [20x1 single]

  Learnable Parameters
    Alpha: [1x1x20 single]

  Show all properties

```

Replace the `p_re_lu_1` layer in `layers` with `tempLayer`.

```

layers = replaceLayer(layers,'p_re_lu_1', tempLayer);
layers.Layers(4)

ans =
  PreluLayer with properties:

    Name: 'p_re_lu_1'
    RawAlpha: [20x1 single]

```



```
Learnable Parameters
  Alpha: [1×1×20 single]
```

```
Show all properties
```

Now the `p_re_lu_1` layer has a vector-valued scaling parameter.

## Input Arguments

### **modelfile** — Name of Keras model file

character vector | string scalar

Name of the model file containing the network architecture, and possibly the weights, specified as a character vector or a string scalar. The file must be in the current folder, in a folder on the MATLAB path, or you must include a full or relative path to the file.

If `modelfile` includes

- The network architecture and weights, then it must be in HDF5 (.h5) format.
- Only the network architecture, then it can be in HDF5 or JSON (.json) format.

If `modelfile` includes only the network architecture, then you can optionally supply the weights using the `'ImportWeights'` and `'WeightFile'` name-value pair arguments. If you supply the weights, then the weights file must be in HDF5 format.

Example: `'digitsnet.h5'`

Data Types: `char` | `string`

### **Name-Value Pair Arguments**

Specify optional comma-separated pairs of `Name, Value` arguments. `Name` is the argument name and `Value` is the corresponding value. `Name` must appear inside quotes. You can specify several name and value pair arguments in any order as `Name1, Value1, ..., NameN, ValueN`.

Example: `importKerasLayers(modelfile, 'OutputLayerType', 'classification')` imports the network layers from the model file `modelfile` and adds an output layer for a classification problem at the end of the Keras layers.

### **OutputLayerType** — Type of output layer

`'classification'` | `'regression'` | `'pixelclassification'`

Type of the output layer that the function appends to the end of the imported network architecture when `modelfile` does not specify a loss function, specified as `'classification'`, `'regression'`, or `'pixelclassification'`. Appending a `pixelClassificationLayer` object requires Computer Vision Toolbox.

If a network in `modelfile` has multiple outputs, then you cannot specify the output layer types using this argument. `importKerasLayers` inserts placeholder layers for the outputs. After importing, you can find and replace the placeholder layers by using `findPlaceholderLayers` and `replaceLayer`, respectively.

Example: `'OutputLayerType', 'regression'`

**ImageInputSize — Size of input images**

vector of two or three numerical values

Size of the input images for the network, specified as a vector of two or three numerical values corresponding to [height,width] for grayscale images and [height,width,channels] for color images, respectively. The network uses this information when the `modelfile` does not specify the input size.

If a network in `modelfile` has multiple inputs, then you cannot specify the input sizes using this argument. `importKerasLayers` inserts placeholder layers for the inputs. After importing, you can find and replace the placeholder layers by using `findPlaceholderLayers` and `replaceLayer`, respectively.

Example: `'ImageInputSize',[28 28]`

**ImportWeights — Indicator to import weights**

false (default) | true

Indicator to import weights as well as the network architecture, specified as either `false` or `true`.

- If `'ImportWeights'` is `true` and `modelfile` includes the weights, then `importKerasLayers` imports the weights from `modelfile`, which must have HDF5 (.h5) format.
- If `'ImportWeights'` is `true` and `modelfile` does not include the weights, then you must specify a separate file that includes weights, using the `'WeightFile'` name-value pair argument.

Example: `'ImportWeights',true`

Data Types: logical

**WeightFile — Weight file name**

character vector | string scalar

Weight file name, from which to import weights when `modelfile` does not include weights, specified as a character vector or a string scalar. To use this name-value pair argument, you also must set `'ImportWeights'` to `true`.

Weight file must be in the current folder, in a folder on the MATLAB path, or you must include a full or relative path to the file.

Example: `'WeightFile','weights.h5'`

Data Types: char | string

**Output Arguments****Layers — Network architecture**

Layer array object | LayerGraph object

Network architecture, returned as a Layer array object when the Keras network is of type `Sequential`, or returned as a LayerGraph object when the Keras network is of type `Model`.

**Tips**

- `importKerasLayers` supports the following Keras layer types, with some limitations. If the network contains any other type of layer, then the software inserts a placeholder layer in place of

the unsupported layer. To find the names and indices of the unsupported layers in the network, use the `findPlaceholderLayers` function. You then can replace a placeholder layer with a new layer that you define. To replace a layer, use `replaceLayer`.

Supported Keras Layer	Corresponding Deep Learning Toolbox Layer
Add	<code>additionLayer</code>
Activation, with activation names: <ul style="list-style-type: none"> <li>'elu'</li> <li>'relu'</li> <li>'linear'</li> <li>'softmax'</li> <li>'sigmoid'</li> <li>'tanh'</li> </ul>	Layers: <ul style="list-style-type: none"> <li><code>eluLayer</code></li> <li><code>reluLayer</code> or <code>clippedReluLayer</code></li> <li>None</li> <li><code>softmaxLayer</code></li> <li><code>nnet.keras.layer.SigmoidLayer</code></li> <li><code>tanhLayer</code></li> </ul>
Advanced activations: <ul style="list-style-type: none"> <li>ELU</li> <li>Softmax</li> <li>ReLU</li> <li>LeakyReLU</li> <li>PReLU*</li> </ul>	Layers: <ul style="list-style-type: none"> <li><code>eluLayer</code></li> <li><code>softmaxLayer</code></li> <li><code>reluLayer</code>, <code>clippedReluLayer</code>, or <code>leakyReluLayer</code></li> <li><code>leakyReluLayer</code></li> <li><code>nnet.keras.layer.PreluLayer</code></li> </ul>
AveragePooling2D	<code>averagePooling2dLayer</code>
BatchNormalization	<code>batchNormalizationLayer</code>
<code>Bidirectional(LSTM(__))</code>	<code>bilstmLayer</code>
Concatenate	<code>depthConcatenationLayer</code>
Conv2D	<code>convolution2dLayer</code>
Conv2DTranspose	<code>transposedConv2dLayer</code>
CuDNNLSTM	<code>lstmLayer</code>
Dense	<code>fullyConnectedLayer</code>
DepthwiseConv2D	<code>groupedConvolution2dLayer</code>
Dropout	<code>dropoutLayer</code>
Embedding	<code>wordEmbeddingLayer</code> (Text Analytics Toolbox)
Flatten	<code>nnet.keras.layer.FlattenCStyleLayer</code>
GlobalAveragePooling2D	<code>globalAveragePooling2dLayer</code>
GlobalMaxPooling2D	<code>globalMaxPooling2dLayer</code>
GRU	<code>gruLayer</code>
Input	<code>imageInputLayer</code>
LSTM	<code>lstmLayer</code>

Supported Keras Layer	Corresponding Deep Learning Toolbox Layer
MaxPooling2D	maxPooling2dLayer
SeparableConv2D	groupedConvolution2dLayer or convolution2dLayer
ZeroPadding2D	nnet.keras.layer.ZeroPadding2DLayer

\*For a PReLU layer, `importKerasLayers` replaces a vector-valued scaling parameter with the average of the vector elements. You can change the parameter back to a vector after import. For an example, see “Import Keras PReLU Layer” on page 1-485.

- You can replace a placeholder layer with a new layer that you define.
  - If the network is a series network, then replace the layer in the array directly. For example, `layer(2) = newlayer;`
  - If the network is a DAG network, then replace the layer using `replaceLayer`. For an example, see “Assemble Network from Pretrained Keras Layers” on page 1-481.
- `importKerasLayers` supports the following Keras loss functions:
  - `mean_squared_error`
  - `categorical_crossentropy`
  - `sparse_categorical_crossentropy`
  - `binary_crossentropy`
- You can import a Keras network with multiple inputs and multiple outputs (MIMO). Use `importKerasNetwork` if the network includes input size information for the inputs and loss information for the outputs. Otherwise, use `importKerasLayers`. The `importKerasLayers` function inserts placeholder layers for the inputs and outputs. After importing, you can find and replace the placeholder layers by using `findPlaceholderLayers` and `replaceLayer`, respectively. The workflow for importing MIMO Keras networks is the same as the workflow for importing MIMO ONNX networks. For an example, see “Import ONNX Network with Multiple Outputs” on page 1-502. To learn about a deep learning network with multiple inputs and multiple outputs, see “Multiple-Input and Multiple-Output Networks”.
- To use a pretrained network for prediction or transfer learning on new images, you must preprocess your images in the same way as the images used to train the imported model were preprocessed. Resizing images, subtracting the average image, and converting the images from RGB to BGR format are the most common preprocessing operations.
  - To resize images, use `imresize`. For example, `imresize(im, [227 227])`.
  - To convert images from RGB to BGR format, use `flip`. For example, `flip(im, 3)`.

For more information on preprocessing images for training and prediction, see “Preprocess Images for Deep Learning”.

## References

- [1] *Keras: The Python Deep Learning library*. <https://keras.io>.

**See Also**

`assembleNetwork` | `exportONNXNetwork` | `findPlaceholderLayers` | `importCaffeLayers` | `importCaffeNetwork` | `importKerasNetwork` | `importONNXLayers` | `importONNXNetwork` | `replaceLayer`

**Topics**

“Deep Learning in MATLAB”

“Pretrained Deep Neural Networks”

“List of Deep Learning Layers”

“Define Custom Deep Learning Layers”

“Define Custom Deep Learning Layer with Learnable Parameters”

“Check Custom Layer Validity”

**Introduced in R2017b**

## importKerasNetwork

Import a pretrained Keras network and weights

### Syntax

```
net = importKerasNetwork(modelfile)
net = importKerasNetwork(modelfile,Name,Value)
```

### Description

`net = importKerasNetwork(modelfile)` imports a pretrained TensorFlow-Keras network and its weights from `modelfile`.

This function requires Deep Learning Toolbox Importer *for TensorFlow-Keras Models* support package. If this support package is not installed, the function provides a download link.

`net = importKerasNetwork(modelfile,Name,Value)` imports a pretrained TensorFlow-Keras network and its weights with additional options specified by one or more name-value pair arguments.

For example, `importKerasNetwork(modelfile,'WeightFile',weights)` imports the network from the model file `modelfile` and weights from the weight file `weights`. In this case, `modelfile` can be in HDF5 or JSON format, and the weight file must be in HDF5 format.

### Examples

#### Download and Install Deep Learning Toolbox Importer for TensorFlow-Keras Models

Download and install the Deep Learning Toolbox Importer for TensorFlow-Keras Models support package.

Type `importKerasNetwork` at the command line.

```
importKerasNetwork
```

If the Deep Learning Toolbox Importer for TensorFlow-Keras Models support package is not installed, then the function provides a link to the required support package in the Add-On Explorer. To install the support package, click the link, and then click **Install**. Check that the installation is successful by importing the network from the model file `'digitsDAGnet.h5'` at the command line. If the required support package is installed, then the function returns a `DAGNetwork` object.

```
modelfile = 'digitsDAGnet.h5';
net = importKerasNetwork(modelfile)
```

Warning: Saved Keras networks do not include classes. Classes will be set to `categorical(1:N)`, where `N` is the number of classes in the classification output layer of the network. To specify classes, use the `'Classes'` argument.

```
net =
```

DAGNetwork with properties:

```
Layers: [13x1 nnet.cnn.layer.Layer]  
Connections: [13x2 table]
```

### Import and Plot Keras Network

Specify the file to import. The file `digitsDAGnet.h5` contains a directed acyclic graph convolutional neural network that classifies images of digits.

```
modelfile = 'digitsDAGnet.h5';
```

Import the network.

```
net = importKerasNetwork(modelfile)
```

Warning: Saved Keras networks do not include classes. Classes will be set to `categorical(1:N)`, wh

```
net =  
DAGNetwork with properties:
```

```
Layers: [13x1 nnet.cnn.layer.Layer]  
Connections: [13x2 table]
```

Plot the network architecture.

```
figure  
plot(net);  
title('DAG Network Architecture')
```

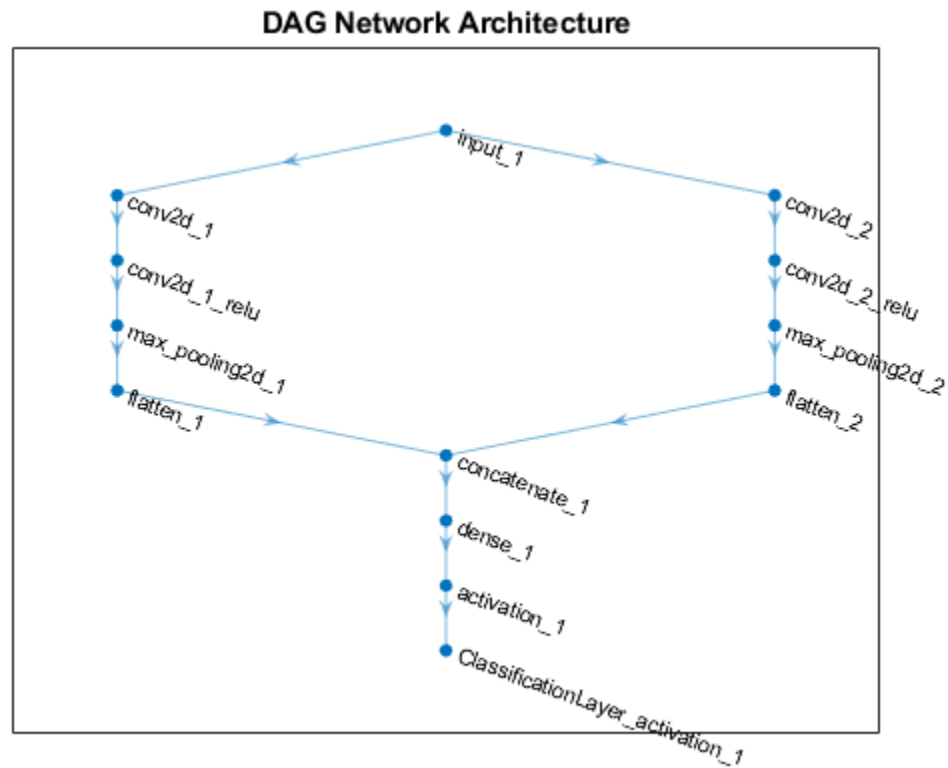

### Import Keras Network and Weights

Specify the network and the weight files to import.

```

modelfile = 'digitsDAGnet.json';
weights = 'digitsDAGnet.weights.h5';

```

This is a directed acyclic graph convolutional neural network trained on the digits data.

Import network architecture and import the weights from separate files. The .json file does not have an output layer or information on the cost function. Specify the output layer type when you import the files.

```

net = importKerasNetwork(modelfile, 'WeightFile', weights, ...
    'OutputLayerType', 'classification')

```

Warning: Saved Keras networks do not include classes. Classes will be set to categorical(1:N), wh

```

net =
  DAGNetwork with properties:

```

```

    Layers: [13x1 nnet.cnn.layer.Layer]
  Connections: [13x2 table]

```



## Import Pretrained Keras Network to Classify Image

Specify the model file.

```
modelfile = 'digitsDAGnet.h5';
```

Specify class names.

```
classNames = {'0','1','2','3','4','5','6','7','8','9'};
```

Import the Keras network with the class names.

```
net = importKerasNetwork(modelfile,'Classes',classNames);
```

Read the image to classify.

```
digitDatasetPath = fullfile(toolboxdir('nnet'),'nndemos','nndatasets', ...
    'DigitDataset');
I = imread(fullfile(digitDatasetPath,'5','image4009.png'));
```

Classify the image using the pretrained network.

```
label = classify(net,I);
```

Display the image and the classification result.

```
figure
imshow(I)
title(['Classification result: ' char(label)])
```

Classification result: 5



## Input Arguments

### modelfile — Name of Keras model file

character vector | string scalar

Name of the model file containing the network architecture, and possibly the weights, specified as a character vector or a string scalar. The file must be in the current folder, in a folder on the MATLAB path, or you must include a full or relative path to the file.

If modelfile includes

- The network architecture and weights, then it must be in HDF5 (.h5) format.
- Only the network architecture, then it can be in HDF5 or JSON (.json) format.

If `modelfile` includes only the network architecture, then you must supply the weights in an HDF5 file, using the `'WeightFile'` name-value pair argument.

Example: `'digitsnet.h5'`

Data Types: `char` | `string`

### **Name-Value Pair Arguments**

Specify optional comma-separated pairs of `Name`, `Value` arguments. `Name` is the argument name and `Value` is the corresponding value. `Name` must appear inside quotes. You can specify several name and value pair arguments in any order as `Name1, Value1, ..., NameN, ValueN`.

Example:

```
importKerasNetwork(modelfile, 'OutputLayerType', 'classification', 'Classes', classes) imports a network from the model file modelfile, adds an output layer for a classification problem at the end of the Keras layers, and specifies classes as the classes of the output layer.
```

### **WeightFile — Name of file containing weights**

character vector | string scalar

Name of file containing weights, specified as a character vector or a string scalar. `WeightFile` must be in the current folder, in a folder on the MATLAB path, or you must include a full or relative path to the file.

Example: `'WeightFile', 'weights.h5'`

### **OutputLayerType — Type of output layer**

`'classification'` | `'regression'` | `'pixelclassification'`

Type of the output layer that the function appends to the end of the imported network architecture when `modelfile` does not specify a loss function, specified as `'classification'`, `'regression'`, or `'pixelclassification'`. Appending a `pixelClassificationLayer` object requires Computer Vision Toolbox.

If a network in `modelfile` has multiple outputs, then you cannot specify the output layer types using this argument. Use `importKerasLayers` instead. `importKerasLayers` inserts placeholder layers for the outputs. After importing, you can find and replace the placeholder layers by using `findPlaceholderLayers` and `replaceLayer`, respectively.

Example: `'OutputLayerType', 'regression'`

### **ImageInputSize — Size of input images**

vector of two or three numerical values

Size of the input images for the network, specified as a vector of two or three numerical values corresponding to `[height, width]` for grayscale images and `[height, width, channels]` for color images, respectively. The network uses this information when the `modelfile` does not specify the input size.

If a network in `modelfile` has multiple inputs, then you cannot specify the input sizes using this argument. Use `importKerasLayers` instead. `importKerasLayers` inserts placeholder layers for the inputs. After importing, you can find and replace the placeholder layers by using `findPlaceholderLayers` and `replaceLayer`, respectively.

Example: `'ImageInputSize', [28 28]`

**Classes — Classes of the output layer**

'auto' (default) | categorical vector | string array | cell array of character vectors

Classes of the output layer, specified as a categorical vector, string array, cell array of character vectors, or 'auto'. If you specify a string array or cell array of character vectors `str`, then the software sets the classes of the output layer to `categorical(str, str)`. If `Classes` is 'auto', then the function sets the classes to `categorical(1:N)`, where `N` is the number of classes.

Data Types: `char` | `categorical` | `string` | `cell`

**Output Arguments****net — Pretrained Keras network**

`SeriesNetwork` object | `DAGNetwork` object

Pretrained Keras network, returned as one of the following:

- If the Keras network is of type `Sequential`, then `net` is a `SeriesNetwork` object.
- If the Keras network is of type `Model`, then `net` is a `DAGNetwork` object.

**Tips**

- `importKerasNetwork` can import a network with the following Keras layer types, with some limitations. If the network contains any other type of layer, then the software returns an error message. In this case, you can still use `importKerasLayers` to import the network architecture and weights.

Supported Keras Layer	Corresponding Deep Learning Toolbox Layer
Add	<code>additionLayer</code>
Activation, with activation names: <ul style="list-style-type: none"> <li>• 'elu'</li> <li>• 'relu'</li> <li>• 'linear'</li> <li>• 'softmax'</li> <li>• 'sigmoid'</li> <li>• 'tanh'</li> </ul>	Layers: <ul style="list-style-type: none"> <li>• <code>eluLayer</code></li> <li>• <code>reluLayer</code> or <code>clippedReluLayer</code></li> <li>• None</li> <li>• <code>softmaxLayer</code></li> <li>• <code>nnet.keras.layer.SigmoidLayer</code></li> <li>• <code>tanhLayer</code></li> </ul>
Advanced activations: <ul style="list-style-type: none"> <li>• ELU</li> <li>• Softmax</li> <li>• ReLU</li> <li>• LeakyReLU</li> <li>• PReLU*</li> </ul>	Layers: <ul style="list-style-type: none"> <li>• <code>eluLayer</code></li> <li>• <code>softmaxLayer</code></li> <li>• <code>reluLayer</code>, <code>clippedReluLayer</code>, or <code>leakyReluLayer</code></li> <li>• <code>leakyReluLayer</code></li> <li>• <code>nnet.keras.layer.PreluLayer</code></li> </ul>
<code>AveragePooling2D</code>	<code>averagePooling2dLayer</code>

Supported Keras Layer	Corresponding Deep Learning Toolbox Layer
BatchNormalization	batchNormalizationLayer
Bidirectional(LSTM(__))	biLstmLayer
Concatenate	depthConcatenationLayer
Conv2D	convolution2dLayer
Conv2DTranspose	transposedConv2dLayer
CuDNNLSTM	lstmLayer
Dense	fullyConnectedLayer
DepthwiseConv2D	groupedConvolution2dLayer
Dropout	dropoutLayer
Embedding	wordEmbeddingLayer (Text Analytics Toolbox)
Flatten	nnet.keras.layer.FlattenCStyleLayer
GlobalAveragePooling2D	globalAveragePooling2dLayer
GlobalMaxPooling2D	globalMaxPooling2dLayer
GRU	gruLayer
Input	imageInputLayer
LSTM	lstmLayer
MaxPooling2D	maxPooling2dLayer
SeparableConv2D	groupedConvolution2dLayer or convolution2dLayer
ZeroPadding2D	nnet.keras.layer.ZeroPadding2DLayer

\*For a PReLU layer, `importKerasNetwork` replaces a vector-valued scaling parameter with the average of the vector elements. You can change the parameter back to a vector after import. For an example, see “Import Keras PReLU Layer” on page 1-485.

- `importKerasNetwork` supports the following Keras loss functions:
  - `mean_squared_error`
  - `categorical_crossentropy`
  - `sparse_categorical_crossentropy`
  - `binary_crossentropy`
- You can import a Keras network with multiple inputs and multiple outputs (MIMO). Use `importKerasNetwork` if the network includes input size information for the inputs and loss information for the outputs. Otherwise, use `importKerasLayers`. The `importKerasLayers` function inserts placeholder layers for the inputs and outputs. After importing, you can find and replace the placeholder layers by using `findPlaceholderLayers` and `replaceLayer`, respectively. The workflow for importing MIMO Keras networks is the same as the workflow for importing MIMO ONNX networks. For an example, see “Import ONNX Network with Multiple Outputs” on page 1-502. To learn about a deep learning network with multiple inputs and multiple outputs, see “Multiple-Input and Multiple-Output Networks”.

- To use a pretrained network for prediction or transfer learning on new images, you must preprocess your images in the same way as the images used to train the imported model were preprocessed. Resizing images, subtracting the average image, and converting the images from RGB to BGR format are the most common preprocessing operations.
  - To resize images, use `imresize`. For example, `imresize(im, [227 227])`.
  - To convert images from RGB to BGR format, use `flip`. For example, `flip(im, 3)`.

For more information on preprocessing images for training and prediction, see “Preprocess Images for Deep Learning”.

## Compatibility Considerations

### 'ClassNames' option will be removed

*Not recommended starting in R2018b*

'ClassNames' will be removed. Use 'Classes' instead. To update your code, replace all instances of 'ClassNames' with 'Classes'. There are some differences between the corresponding properties in classification output layers that require additional updates to your code.

The `ClassNames` property of a classification output layer is a cell array of character vectors. The `Classes` property is a categorical array. To use the value of `Classes` with functions that require cell array input, convert the classes using the `cellstr` function.

## References

[1] *Keras: The Python Deep Learning library*. <https://keras.io>.

## See Also

`exportONNXNetwork` | `importCaffeLayers` | `importCaffeNetwork` | `importKerasLayers` | `importONNXLayers` | `importONNXNetwork`

## Topics

“Preprocess Images for Deep Learning”

“Deep Learning in MATLAB”

“Pretrained Deep Neural Networks”

## Introduced in R2017b

## importONNXLayers

Import layers from ONNX network

### Syntax

```
layers = importONNXLayers(modelfile)
layers = importONNXLayers(modelfile,Name,Value)
```

### Description

`layers = importONNXLayers(modelfile)` imports the layers of an ONNX (Open Neural Network Exchange) network from the file `modelfile`. You can train the imported layers on a new data set or assemble the layers into a network ready for prediction. For an example of the workflow of assembling a network, see “Assemble Network from Pretrained Keras Layers”.

This function requires the Deep Learning Toolbox Converter for ONNX Model Format support package. If this support package is not installed, then the function provides a download link.

`layers = importONNXLayers(modelfile,Name,Value)` imports the layers from an ONNX network with additional options specified by one or more name-value pair arguments.

For example, `importONNXLayers(modelfile, 'ImportWeights', false)` imports the network architecture without weights from the file `modelfile`.

### Examples

#### Download and Install Deep Learning Toolbox Converter for ONNX Model Format

Download and install the Deep Learning Toolbox Converter for ONNX Model Format support package.

Type `importONNXLayers` at the command line.

```
importONNXLayers
```

If Deep Learning Toolbox Converter for ONNX Model Format is not installed, then the function provides a link to the required support package in the Add-On Explorer. To install the support package, click the link, and then click **Install**. Check that the installation is successful by importing the network from the model file `'cifarResNet.onnx'` at the command line. If the support package is installed, then the function returns a `DAGNetwork` object.

```
modelfile = 'cifarResNet.onnx';
layers = importONNXLayers(modelfile, 'OutputLayerType', 'classification')
```

```
layers =
```

```
    LayerGraph with properties:
```

```
Layers: [77x1 nnet.cnn.layer.Layer]
Connections: [85x2 table]
```

## Import ONNX Network Architecture

Import the architecture and weights of a residual neural network trained on the CIFAR-10 data set. Specify the file containing the ONNX network and the type of the output layer to add to the imported network.



```
modelfile = 'cifarResNet.onnx';
lgraph = importONNXLayers(modelfile, ...
    'OutputLayerType','classification', ...
    'ImportWeights',true)
```

```
lgraph =
    LayerGraph with properties:
```

```
Layers: [77x1 nnet.cnn.layer.Layer]
Connections: [85x2 table]
```

Analyze the imported network architecture.

```
analyzeNetwork(lgraph);
```

**lgraph** 77  layers 0  warnings 0  errors  
 Analysis date: 04-Jul-2018 12:01:59

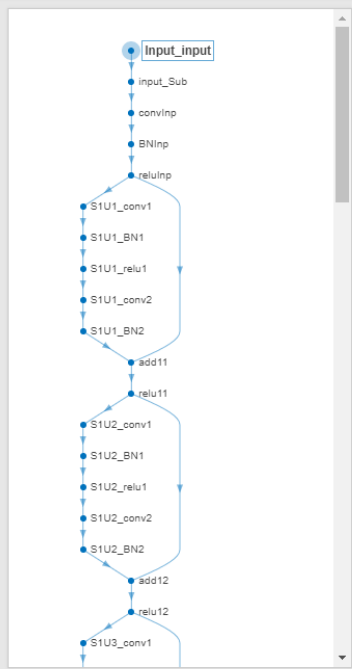

**ANALYSIS RESULT**

#	NAME	TYPE	ACTIVATIONS	LEARNABLES
1	Input_input 32x32x3 images	Image Input	32x32x3	-
2	input_Sub Layer adds bias to the input	Bias	32x32x3	-
3	conv1np 16 3x3x3 convolutions with stride [1 1] and padding [1 1 1]	Convolution	32x32x16	Weights 3x3x3x16 Bias 1x1x16
4	BN1np Batch normalization with 16 channels	Batch Normalization	32x32x16	Offset 1x1x16 Scale 1x1x16
5	relu1np ReLU	ReLU	32x32x16	-
6	S1U1_conv1 16 3x3x16 convolutions with stride [1 1] and padding [1 1 1]	Convolution	32x32x16	Weights 3x3x16x16 Bias 1x1x16
7	S1U1_BN1 Batch normalization with 16 channels	Batch Normalization	32x32x16	Offset 1x1x16 Scale 1x1x16
8	S1U1_relu1 ReLU	ReLU	32x32x16	-
9	S1U1_conv2 16 3x3x16 convolutions with stride [1 1] and padding [1 1 1]	Convolution	32x32x16	Weights 3x3x16x16 Bias 1x1x16
10	S1U1_BN2 Batch normalization with 16 channels	Batch Normalization	32x32x16	Offset 1x1x16 Scale 1x1x16
11	add11 Element-wise addition of 2 inputs	Addition	32x32x16	-
12	relu11 ReLU	ReLU	32x32x16	-
13	S1U2_conv1 16 3x3x16 convolutions with stride [1 1] and padding [1 1 1]	Convolution	32x32x16	Weights 3x3x16x16 Bias 1x1x16
14	S1U2_BN1 Batch normalization with 16 channels	Batch Normalization	32x32x16	Offset 1x1x16 Scale 1x1x16
15	S1U2_relu1 ReLU	ReLU	32x32x16	-
16	S1U2_conv2 16 3x3x16 convolutions with stride [1 1] and padding [1 1 1]	Convolution	32x32x16	Weights 3x3x16x16 Bias 1x1x16
17	S1U2_BN2 Batch normalization with 16 channels	Batch Normalization	32x32x16	Offset 1x1x16 Scale 1x1x16

### Import ONNX Network with Multiple Outputs

Import an ONNX network that has multiple outputs by using `importONNXLayers`. The function inserts placeholder layers for the outputs. After importing, you can find and replace the placeholder layers by using `findPlaceholderLayers` and `replaceLayer`, respectively.

Specify the network file from which to import layers and weights.

```
modelfile = 'digitsMIMO.onnx';
```

The network in `digitsMIMO.onnx` has two output layers: one classification layer to classify digits and one regression layer to compute the mean squared error for the predicted angles of the digits. Import the layers and weights from `modelfile`.

```
layers = importONNXLayers('digitsMIMO.onnx','ImportWeights',true)
```

Warning: ONNX network has multiple outputs. `importONNXLayers` inserts placeholder layers for the o

```
layers =  
  LayerGraph with properties:  
  
    Layers: [19x1 nnet.cnn.layer.Layer]  
    Connections: [19x2 table]  
    InputNames: {'Input_input'}  
    OutputNames: {1x0 cell}
```

`importONNXLayers` displays a warning and inserts placeholder layers for the output layers.

Plot the layer graph using `plot`.

```
plot(layers)
```



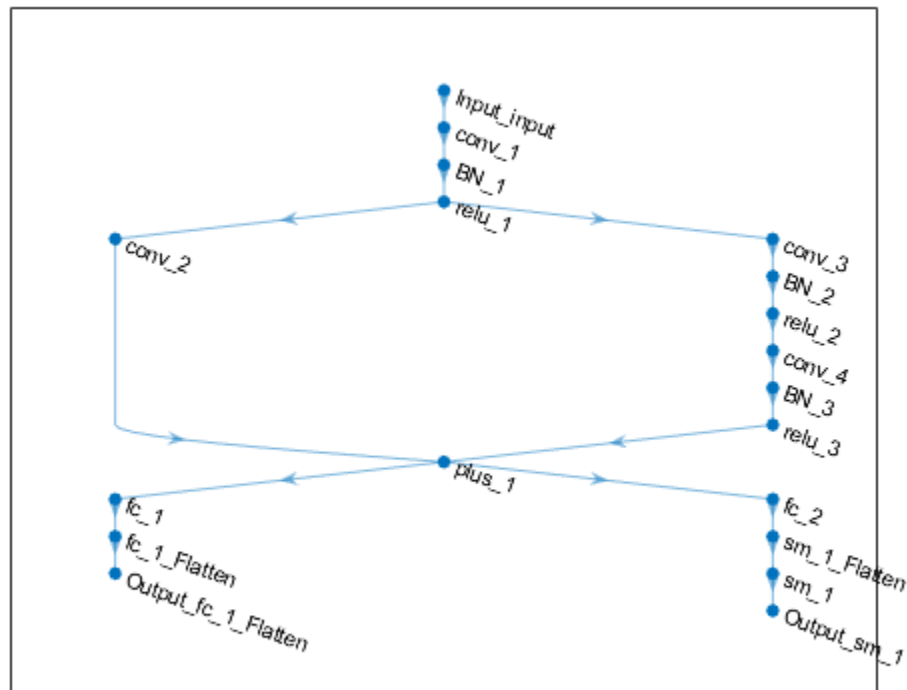

The layer graph has two output layers: `Output_fc_1_Flatten` and `Output_sm_1`. These two layers are the placeholders for the outputs. You can check the placeholder layers by viewing the `Layers` property or by using the `findPlaceholderLayers` function.

`layers.Layers`

`ans =`

19x1 Layer array with layers:

1	'Input_input'	Image Input	28x28x1 images
2	'conv_1'	Convolution	16 5x5x1 convolutions with stride [1 1]
3	'BN_1'	Batch Normalization	Batch normalization with 16 channels
4	'relu_1'	ReLU	ReLU
5	'conv_2'	Convolution	32 1x1x16 convolutions with stride [2 2]
6	'conv_3'	Convolution	32 3x3x16 convolutions with stride [2 2]
7	'BN_2'	Batch Normalization	Batch normalization with 32 channels
8	'relu_2'	ReLU	ReLU
9	'conv_4'	Convolution	32 3x3x32 convolutions with stride [1 1]
10	'BN_3'	Batch Normalization	Batch normalization with 32 channels
11	'relu_3'	ReLU	ReLU
12	'plus_1'	Addition	Element-wise addition of 2 inputs
13	'fc_1'	Convolution	1 14x14x32 convolutions with stride [1 1]
14	'fc_2'	Convolution	10 14x14x32 convolutions with stride [1 1]
15	'sm_1_Flatten'	ONNX Flatten	Flatten activations into 1-D assuming C-s
16	'sm_1'	Softmax	softmax
17	'Output_sm_1'	PLACEHOLDER LAYER	Placeholder for 'Output' ONNX operator
18	'fc_1_Flatten'	ONNX Flatten	Flatten activations into 1-D assuming C-s
19	'Output_fc_1_Flatten'	PLACEHOLDER LAYER	Placeholder for 'Output' ONNX operator

```
placeholderLayers = findPlaceholderLayers(layers)
```

```
placeholderLayers =
    2x1 PlaceholderOutputLayer array with layers:
```

```
    1 'Output_sm_1'          PLACEHOLDER LAYER Placeholder for 'Output' ONNX operator
    2 'Output_fc_1_Flatten' PLACEHOLDER LAYER Placeholder for 'Output' ONNX operator
```

Create output layers to replace the placeholder layers. First, create a classification layer with the name `Output_sm_1`. Specify the classes of the output layer as 0, 1, ..., 9. If you do not specify the classes, then the software automatically sets them to 1, 2, ..., N, where N is the number of classes.

```
output1 = classificationLayer('Name','Output_sm_1','Classes',string(0:9));
```

Create a regression layer with the name `Output_fc_1_Flatten`.

```
output2 = regressionLayer('Name','Output_fc_1_Flatten');
```

Replace the placeholder layers with `output1` and `output2` using `replaceLayer`.

```
layers = replaceLayer(layers,'Output_sm_1',output1);
layers = replaceLayer(layers,'Output_fc_1_Flatten',output2);
```

Display the `Layers` property of the layer graph to confirm the replacement.

```
layers.Layers
```

```
ans =
    19x1 Layer array with layers:
```

1	'Input_input'	Image Input	28x28x1 images
2	'conv_1'	Convolution	16 5x5x1 convolutions with stride [1 1 1]
3	'BN_1'	Batch Normalization	Batch normalization with 16 channels
4	'relu_1'	ReLU	ReLU
5	'conv_2'	Convolution	32 1x1x16 convolutions with stride [2 2 1]
6	'conv_3'	Convolution	32 3x3x16 convolutions with stride [2 2 1]
7	'BN_2'	Batch Normalization	Batch normalization with 32 channels
8	'relu_2'	ReLU	ReLU
9	'conv_4'	Convolution	32 3x3x32 convolutions with stride [1 1 1]
10	'BN_3'	Batch Normalization	Batch normalization with 32 channels
11	'relu_3'	ReLU	ReLU
12	'plus_1'	Addition	Element-wise addition of 2 inputs
13	'fc_1'	Convolution	1 14x14x32 convolutions with stride [1 1 1]
14	'fc_2'	Convolution	10 14x14x32 convolutions with stride [1 1 1]
15	'sm_1_Flatten'	ONNX Flatten	Flatten activations into 1-D assuming C-contiguous
16	'sm_1'	Softmax	softmax
17	'Output_sm_1'	Classification Output	crossentropyex with '0' and 9 other classes
18	'fc_1_Flatten'	ONNX Flatten	Flatten activations into 1-D assuming C-contiguous
19	'Output_fc_1_Flatten'	Regression Output	mean-squared-error

Assemble the layer graph using `assembleNetwork`. The function returns a `DAGNetwork` object that is ready to use for prediction.

```
assembledNet = assembleNetwork(layers)
```

```
assembledNet =
    DAGNetwork with properties:
```

```
    Layers: [19x1 nnet.cnn.layer.Layer]
```

```
Connections: [19x2 table]
InputNames: {'Input_input'}
OutputNames: {'Output_sm_1' 'Output_fc_1_Flatten'}
```

## Input Arguments

### **modelfile** — Name of ONNX model file

character vector | string scalar

Name of ONNX model file containing the network, specified as a character vector or a string scalar. The file must be in the current folder, in a folder on the MATLAB path, or you must include a full or relative path to the file.

Example: 'cifarResNet.onnx'

### **Name-Value Pair Arguments**

Specify optional comma-separated pairs of **Name**, **Value** arguments. **Name** is the argument name and **Value** is the corresponding value. **Name** must appear inside quotes. You can specify several name and value pair arguments in any order as **Name1**, **Value1**, ..., **NameN**, **ValueN**.

Example: `importONNXLayers(modelfile, 'OutputLayerType', 'classification')` imports the network layers from `modelfile` and adds an output layer for a classification output layer at the end of the imported layers.

### **OutputLayerType** — Type of output layer

'classification' | 'regression' | 'pixelclassification'

Type of the output layer that the function appends to the end of the imported network architecture, specified as 'classification', 'regression', or 'pixelclassification'. Using 'pixelclassification' appends a `pixelClassificationLayer` object (requires Computer Vision Toolbox).

If a network in `modelfile` has multiple outputs, then you cannot specify the output layer types using this argument. `importONNXLayers` inserts placeholder layers for the outputs. After importing, you can find and replace the placeholder layers by using `findPlaceholderLayers` and `replaceLayer`, respectively.

Example: 'OutputLayerType', 'regression'

### **ImportWeights** — Indicator to import weights

false (default) | true

Indicator to import weights as well as the network architecture, specified as either `false` or `true`.

Example: 'ImportWeights', true

Data Types: logical

## Output Arguments

### **layers** — Network architecture

LayerGraph object

Network architecture, returned as a LayerGraph object.

## Tips

- If the ONNX network contains a layer that Deep Learning Toolbox Converter for ONNX Model Format does not support, then `importONNXLayers` inserts a placeholder layer in place of the unsupported layer. To find the names and indices of the unsupported layers in the network, use the `findPlaceholderLayers` function. You then can replace a placeholder layer with a new layer that you define. To replace a layer, use `replaceLayer`.
- `importONNXLayers` supports the following ONNX layers, with some limitations:

ONNX Layer	Deep Learning Toolbox Layer
Add	<code>additionLayer</code> or <code>nnet.onnx.layer.ElementwiseAffineLayer</code>
AveragePool	<code>averagePooling2dLayer</code>
BatchNormalization	<code>batchNormalizationLayer</code>
Clip	<code>nnet.onnx.layer.ClipLayer</code>
Concat	<code>concatenationLayer</code>
Constant	None (Imported as weights)
Conv	<code>convolution2dLayer</code>
ConvTranspose	<code>transposedConv2dLayer</code>
Div	<code>nnet.onnx.layer.ElementwiseAffineLayer</code>
Dropout	<code>dropoutLayer</code>
Flatten	<code>nnet.onnx.layer.FlattenLayer</code> or <code>nnet.onnx.layer.Flatten3dLayer</code>
Elu	<code>eluLayer</code>
Gemm	<code>nnet.onnx.layer.FlattenLayer</code> and <code>fullyConnectedLayer</code> if ONNX network is recurrent, otherwise <code>fullyConnectedLayer</code>
GlobalAveragePool	<code>globalAveragePooling2dLayer</code>
GlobalMaxPool	<code>globalMaxPooling2dLayer</code>
GRU	<code>gruLayer</code>
Identity	<code>nnet.onnx.layer.IdentityLayer</code>
ImageScaler	<code>nnet.onnx.layer.ElementwiseAffineLayer</code>
LeakyRelu	<code>leakyReluLayer</code>
LRN	<code>CrossChannelNormalizationLayer</code>
LSTM	<code>lstmLayer</code> or <code>biLstmLayer</code>
MatMul	<code>fullyConnectedLayer</code>
MaxPool	<code>maxPooling2dLayer</code>

ONNX Layer	Deep Learning Toolbox Layer
Mul	nnet.onnx.layer.ElementwiseAffineLayer
PReLU	nnet.onnx.layer.PReLULayer
ReLU	reluLayer or clippedReLULayer
Reshape	nnet.onnx.layer.FlattenLayer
Sigmoid	nnet.onnx.layer.SigmoidLayer
Softmax	softmaxLayer
Sub	nnet.onnx.layer.ElementwiseAffineLayer
Sum	additionLayer
Tanh	tanhLayer

- The workflow for assembling layers imported from ONNX into a network ready for prediction is the same as assembling layers imported from Keras. For an example of this workflow, see “Assemble Network from Pretrained Keras Layers”.
- You can import an ONNX network with multiple inputs and multiple outputs. If the network has multiple inputs and a single output, use `importONNXNetwork`. If the network has multiple outputs, use `importONNXLayers`. The `importONNXLayers` function inserts placeholder layers for the outputs. After importing, you can find and replace the placeholder layers by using `findPlaceholderLayers` and `replaceLayer`, respectively. For an example, see “Import ONNX Network with Multiple Outputs” on page 1-502. To learn about a deep learning network with multiple inputs and multiple outputs, see “Multiple-Input and Multiple-Output Networks”.
- To use a pretrained network for prediction or transfer learning on new images, you must preprocess your images in the same way the images that were used to train the imported model were preprocessed. Most common preprocessing steps are resizing images, subtracting image average values, and converting the images from BGR images to RGB.
  - To resize images, use `imresize`. For example, `imresize(image,[227,227,3])`.
  - To convert images from RGB to BGR format, use `flip`. For example, `flip(image,3)`.

For more information on preprocessing images for training and prediction, see “Preprocess Images for Deep Learning”.

## References

[1] *Open Neural Network Exchange*. <https://github.com/onnx/>.

[2] *ONNX*. <https://onnx.ai/>.

## See Also

`assembleNetwork` | `exportONNXNetwork` | `findPlaceholderLayers` | `importCaffeLayers` | `importCaffeNetwork` | `importKerasLayers` | `importKerasNetwork` | `importONNXNetwork` | `replaceLayer`

## Topics

“Deep Learning in MATLAB”

“Pretrained Deep Neural Networks”

“List of Deep Learning Layers”

“Define Custom Deep Learning Layers”

“Define Custom Deep Learning Layer with Learnable Parameters”

“Check Custom Layer Validity”

“Assemble Network from Pretrained Keras Layers”

**Introduced in R2018a**

# importONNXNetwork

Import pretrained ONNX network

## Syntax

```
net = importONNXNetwork(modelfile, 'OutputLayerType', outputtype)
net = importONNXNetwork(modelfile, 'OutputLayerType', outputtype, 'Classes',
classes)
```

## Description

`net = importONNXNetwork(modelfile, 'OutputLayerType', outputtype)` imports a pretrained network from the ONNX (Open Neural Network Exchange) file `modelfile` and specifies the output layer type of the imported network.

This function requires the Deep Learning Toolbox Converter for ONNX Model Format support package. If this support package is not installed, then the function provides a download link.

`net = importONNXNetwork(modelfile, 'OutputLayerType', outputtype, 'Classes', classes)` additionally specifies the classes for a classification network.

## Examples

### Download and Install Deep Learning Toolbox Converter for ONNX Model Format

Download and install the Deep Learning Toolbox Converter for ONNX Model Format support package.

Type `importONNXNetwork` at the command line.

```
importONNXNetwork
```

If Deep Learning Toolbox Converter for ONNX Model Format is not installed, then the function provides a link to the required support package in the Add-On Explorer. To install the support package, click the link, and then click **Install**. Check that the installation is successful by importing the network from the model file `'cifarResNet.onnx'` at the command line. If the support package is installed, then the function returns a `DAGNetwork` object.

```
modelfile = 'cifarResNet.onnx';
classes = ["airplane" "automobile" "bird" "cat" "deer" "dog" "frog" "horse" "ship" "truck"];
net = importONNXNetwork(modelfile, 'OutputLayerType', 'classification', 'Classes', classes)
```

```
net =
```

```
DAGNetwork with properties:
```

```
    Layers: [77x1 nnet.cnn.layer.Layer]
Connections: [85x2 table]
```

## Import ONNX Network

Import a residual neural network trained on the CIFAR-10 data set. Specify the file containing the ONNX network, its output type, and its output classes.

```
modelfile = 'cifarResNet.onnx';
classes = ["airplane" "automobile" "bird" "cat" "deer" "dog" "frog" "horse" "ship" "truck"];
net = importONNXNetwork(modelfile, ...
    'OutputLayerType','classification', ...
    'Classes',classes)
```

```
net =
    DAGNetwork with properties:

        Layers: [77x1 nnet.cnn.layer.Layer]
        Connections: [85x2 table]
```

Analyze the imported network.

```
analyzeNetwork(net)
```

net  
Analysis date: 04-Jul-2018 08:16:54

77 layers    0 warnings    0 errors

	NAME	TYPE	ACTIVATIONS	LEARNABLES
1	Input_input 32x32x3 images	Image Input	32x32x3	-
2	input_Sub Layer adds bias to the input	Bias	32x32x3	-
3	conv1np 18 3x3x3 convolutions with stride [1 1] and padding [1 1 1]	Convolution	32x32x16	Weights 3x3x3x16 Bias 1x1x16
4	BN1np Batch normalization with 16 channels	Batch Normalization	32x32x16	Offset 1x1x16 Scale 1x1x16
5	relu1np ReLU	ReLU	32x32x16	-
6	S1U1_conv1 18 3x3x16 convolutions with stride [1 1] and padding [1 1 1]	Convolution	32x32x16	Weights 3x3x16x16 Bias 1x1x16
7	S1U1_BN1 Batch normalization with 16 channels	Batch Normalization	32x32x16	Offset 1x1x16 Scale 1x1x16
8	S1U1_relu1 ReLU	ReLU	32x32x16	-
9	S1U1_conv2 18 3x3x16 convolutions with stride [1 1] and padding [1 1 1]	Convolution	32x32x16	Weights 3x3x16x16 Bias 1x1x16
10	S1U1_BN2 Batch normalization with 16 channels	Batch Normalization	32x32x16	Offset 1x1x16 Scale 1x1x16
11	add11 Element-wise addition of 2 inputs	Addition	32x32x16	-
12	relu11 ReLU	ReLU	32x32x16	-
13	S1U2_conv1 18 3x3x16 convolutions with stride [1 1] and padding [1 1 1]	Convolution	32x32x16	Weights 3x3x16x16 Bias 1x1x16
14	S1U2_BN1 Batch normalization with 16 channels	Batch Normalization	32x32x16	Offset 1x1x16 Scale 1x1x16
15	S1U2_relu1 ReLU	ReLU	32x32x16	-
16	S1U2_conv2 18 3x3x16 convolutions with stride [1 1] and padding [1 1 1]	Convolution	32x32x16	Weights 3x3x16x16 Bias 1x1x16
17	S1U2_BN2 Batch normalization with 16 channels	Batch Normalization	32x32x16	Offset 1x1x16 Scale 1x1x16

## Input Arguments

**modelfile** — Name of ONNX model file  
character vector | string scalar



Name of ONNX model file containing the network, specified as a character vector or a string scalar. The file must be in the current folder, in a folder on the MATLAB path, or you must include a full or relative path to the file.

Example: 'cifarResNet.onnx'

### outputtype — Type of output layer

'classification' | 'regression' | 'pixelclassification'

Type of the output layer that the function appends to the end of the imported network, specified as 'classification', 'regression', or 'pixelclassification'. Using 'pixelclassification' appends a pixelClassificationLayer object (requires Computer Vision Toolbox).

If a network in modelfile has multiple outputs, then you cannot specify the output layer types using this argument. Use importONNXLayers instead. importONNXLayers inserts placeholder layers for the outputs. After importing, you can find and replace the placeholder layers by using findPlaceholderLayers and replaceLayer, respectively.

Example: 'regression'

### classes — Classes of the output layer

'auto' (default) | categorical vector | string array | cell array of character vectors

Classes of the output layer, specified as a categorical vector, string array, cell array of character vectors, or 'auto'. If Classes is 'auto', then the software sets the classes to categorical(1:N), where N is the number of classes. If you specify a string array or cell array of character vectors str, then the software sets the classes of the output layer to categorical(str,str).

Data Types: char | categorical | string | cell

## Output Arguments

### net — Pretrained network

DAGNetwork object

Pretrained network, returned as DAGNetwork object.

## Tips

- If the ONNX network contains a layer that Deep Learning Toolbox Converter for ONNX Model Format does not support, then the function returns an error message. In this case, you can still use importONNXLayers to import the network architecture and weights.
- importONNXNetwork supports the following ONNX layers, with some limitations:

ONNX Layer	Deep Learning Toolbox Layer
Add	additionLayer or nnet.onnx.layer.ElementwiseAffineLayer
AveragePool	averagePooling2dLayer
BatchNormalization	batchNormalizationLayer

ONNX Layer	Deep Learning Toolbox Layer
Clip	<code>nnet.onnx.layer.ClipLayer</code>
Concat	<code>concatenationLayer</code>
Constant	None (Imported as weights)
Conv	<code>convolution2dLayer</code>
ConvTranspose	<code>transposedConv2dLayer</code>
Div	<code>nnet.onnx.layer.ElementwiseAffineLayer</code>
Dropout	<code>dropoutLayer</code>
Flatten	<code>nnet.onnx.layer.FlattenLayer</code> or <code>nnet.onnx.layer.Flatten3dLayer</code>
Elu	<code>eluLayer</code>
Gemm	<code>nnet.onnx.layer.FlattenLayer</code> and <code>fullyConnectedLayer</code> if ONNX network is recurrent, otherwise <code>fullyConnectedLayer</code>
GlobalAveragePool	<code>globalAveragePooling2dLayer</code>
GlobalMaxPool	<code>globalMaxPooling2dLayer</code>
GRU	<code>gruLayer</code>
Identity	<code>nnet.onnx.layer.IdentityLayer</code>
ImageScaler	<code>nnet.onnx.layer.ElementwiseAffineLayer</code>
LeakyRelu	<code>leakyReluLayer</code>
LRN	<code>CrossChannelNormalizationLayer</code>
LSTM	<code>lstmLayer</code> or <code>biLstmLayer</code>
MatMul	<code>fullyConnectedLayer</code>
MaxPool	<code>maxPooling2dLayer</code>
Mul	<code>nnet.onnx.layer.ElementwiseAffineLayer</code>
PReLU	<code>nnet.onnx.layer.PReLULayer</code>
Relu	<code>reluLayer</code> or <code>clippedReluLayer</code>
Reshape	<code>nnet.onnx.layer.FlattenLayer</code>
Sigmoid	<code>nnet.onnx.layer.SigmoidLayer</code>
Softmax	<code>softmaxLayer</code>
Sub	<code>nnet.onnx.layer.ElementwiseAffineLayer</code>
Sum	<code>additionLayer</code>
Tanh	<code>tanhLayer</code>

- You can import an ONNX network with multiple inputs and a single output using `importONNXNetwork`. If the network has multiple outputs, use `importONNXLayers`. The `importONNXLayers` function inserts placeholder layers for the outputs. After importing, you can

find and replace the placeholder layers by using `findPlaceholderLayers` and `replaceLayer`, respectively. For an example, see “Import ONNX Network with Multiple Outputs” on page 1-502. To learn about a deep learning network with multiple inputs and multiple outputs, see “Multiple-Input and Multiple-Output Networks”.

- To use a pretrained network for prediction or transfer learning on new images, you must preprocess your images in the same way the images that were used to train the imported model were preprocessed. Most common preprocessing steps are resizing images, subtracting image average values, and converting the images from BGR images to RGB.
  - To resize images, use `imresize`. For example, `imresize(image,[227,227,3])`.
  - To convert images from RGB to BGR format, use `flip`. For example, `flip(image,3)`.

For more information on preprocessing images for training and prediction, see “Preprocess Images for Deep Learning”.

## Compatibility Considerations

### 'ClassNames' option will be removed

*Not recommended starting in R2018b*

'ClassNames' will be removed. Use 'Classes' instead. To update your code, replace all instances of 'ClassNames' with 'Classes'. There are some differences between the corresponding properties in classification output layers that require additional updates to your code.

The `ClassNames` property of a classification output layer is a cell array of character vectors. The `Classes` property is a categorical array. To use the value of `Classes` with functions that require cell array input, convert the classes using the `cellstr` function.

## References

[1] *Open Neural Network Exchange*. <https://github.com/onnx/>.

[2] *ONNX*. <https://onnx.ai/>.

## See Also

`exportONNXNetwork` | `importCaffeLayers` | `importCaffeNetwork` | `importKerasLayers` | `importKerasNetwork` | `importONNXLayers`

### Topics

“Preprocess Images for Deep Learning”

“Deep Learning in MATLAB”

“Pretrained Deep Neural Networks”

### Introduced in R2018a

## inceptionresnetv2

Pretrained Inception-ResNet-v2 convolutional neural network

### Syntax

```
net = inceptionresnetv2
```

### Description

Inception-ResNet-v2 is a convolutional neural network that is trained on more than a million images from the ImageNet database [1]. The network is 164 layers deep and can classify images into 1000 object categories, such as keyboard, mouse, pencil, and many animals. As a result, the network has learned rich feature representations for a wide range of images. The network has an image input size of 299-by-299. For more pretrained networks in MATLAB, see “Pretrained Deep Neural Networks”.

You can use `classify` to classify new images using the Inception-ResNet-v2 network. Follow the steps of “Classify Image Using GoogLeNet” and replace GoogLeNet with Inception-ResNet-v2.

To retrain the network on a new classification task, follow the steps of “Train Deep Learning Network to Classify New Images” and load Inception-ResNet-v2 instead of GoogLeNet.

`net = inceptionresnetv2` returns a pretrained Inception-ResNet-v2 network.

This function requires the Deep Learning Toolbox Model *for Inception-ResNet-v2 Network* support package. If this support package is not installed, then the function provides a download link.

### Examples

#### Load Inception-ResNet-v2 Network

Download and install the Deep Learning Toolbox Model *for Inception-ResNet-v2 Network* support package.

Type `inceptionresnetv2` at the command line.

```
inceptionresnetv2
```

If the Deep Learning Toolbox Model *for Inception-ResNet-v2 Network* support package is not installed, then the function provides a link to the required support package in the Add-On Explorer. To install the support package, click the link, and then click **Install**. Check that the installation is successful by typing `inceptionresnetv2` at the command line. If the required support package is installed, then the function returns a `DAGNetwork` object.

```
net = inceptionresnetv2
```

```
net =
```

```
    DAGNetwork with properties:
```

```
Layers: [825x1 nnet.cnn.layer.Layer]
Connections: [922x2 table]
```

## Output Arguments

### **net** — Pretrained Inception-ResNet-v2 convolutional neural network

DAGNetwork object

Pretrained Inception-ResNet-v2 convolutional neural network, returned as a DAGNetwork object.

## References

[1] *ImageNet*. <http://www.image-net.org>

[2] Szegedy, Christian, Sergey Ioffe, Vincent Vanhoucke, and Alexander A. Alemi. "Inception-v4, Inception-ResNet and the Impact of Residual Connections on Learning." In *AAAI*, vol. 4, p. 12. 2017.

[3] <https://keras.io/applications/#inceptionresnetv2>

## Extended Capabilities

### **C/C++ Code Generation**

Generate C and C++ code using MATLAB® Coder™.

For code generation, you can load the network by using the syntax `net = inceptionresnetv2` or by passing the `inceptionresnetv2` function to `coder.loadDeepLearningNetwork`. For example:  
`net = coder.loadDeepLearningNetwork('inceptionresnetv2')`

For more information, see “Load Pretrained Networks for Code Generation” (MATLAB Coder).

### **GPU Code Generation**

Generate CUDA® code for NVIDIA® GPUs using GPU Coder™.

Usage notes and limitations:

For code generation, you can load the network by using the syntax `net = inceptionresnetv2` or by passing the `inceptionresnetv2` function to `coder.loadDeepLearningNetwork`. For example:  
`net = coder.loadDeepLearningNetwork('inceptionresnetv2')`

For more information, see “Load Pretrained Networks for Code Generation” (GPU Coder).

## See Also

DAGNetwork | alexnet | densenet201 | googlenet | importKerasLayers | importKerasNetwork | inceptionv3 | layerGraph | plot | resnet101 | resnet18 | resnet50 | squeezenet | trainNetwork | vgg16 | vgg19

### **Topics**

“Deep Learning in MATLAB”

“Pretrained Deep Neural Networks”

“Classify Image Using GoogLeNet”

“Train Deep Learning Network to Classify New Images”

“Train Residual Network for Image Classification”

**Introduced in R2017b**

# inceptionv3

Inception-v3 convolutional neural network

## Syntax

```
net = inceptionv3
net = inceptionv3('Weights','imagenet')

lgraph = inceptionv3('Weights','none')
```

## Description

Inception-v3 is a convolutional neural network that is 48 layers deep. You can load a pretrained version of the network trained on more than a million images from the ImageNet database [1]. The pretrained network can classify images into 1000 object categories, such as keyboard, mouse, pencil, and many animals. As a result, the network has learned rich feature representations for a wide range of images. The network has an image input size of 299-by-299. For more pretrained networks in MATLAB, see “Pretrained Deep Neural Networks”.

You can use `classify` to classify new images using the Inception-v3 model. Follow the steps of “Classify Image Using GoogLeNet” and replace GoogLeNet with Inception-v3.

To retrain the network on a new classification task, follow the steps of “Train Deep Learning Network to Classify New Images” and load Inception-v3 instead of GoogLeNet.

`net = inceptionv3` returns an Inception-v3 network trained on the ImageNet database.

This function requires the Deep Learning Toolbox Model *for Inception-v3 Network* support package. If this support package is not installed, then the function provides a download link.

`net = inceptionv3('Weights','imagenet')` returns an Inception-v3 network trained on the ImageNet database. This syntax is equivalent to `net = inceptionv3`.

`lgraph = inceptionv3('Weights','none')` returns the untrained Inception-v3 network architecture. The untrained model does not require the support package.

## Examples

### Download Inception-v3 Support Package

Download and install the Deep Learning Toolbox Model *for Inception-v3 Network* support package.

Type `inceptionv3` at the command line.

```
inceptionv3
```

If the Deep Learning Toolbox Model *for Inception-v3 Network* support package is not installed, then the function provides a link to the required support package in the Add-On Explorer. To install the support package, click the link, and then click **Install**. Check that the installation is successful by

typing `inceptionv3` at the command line. If the required support package is installed, then the function returns a `DAGNetwork` object.

```
inceptionv3
```

```
ans =
```

```
DAGNetwork with properties:
```

```
    Layers: [316x1 nnet.cnn.layer.Layer]  
 Connections: [350x2 table]
```

## Output Arguments

### **net** — Pretrained Inception-v3 convolutional neural network

`DAGNetwork` object

Pretrained Inception-v3 convolutional neural network, returned as a `DAGNetwork` object.

### **lgraph** — Untrained Inception-v3 convolutional neural network architecture

`LayerGraph` object

Untrained Inception-v3 convolutional neural network architecture, returned as a `LayerGraph` object.

## References

[1] *ImageNet*. <http://www.image-net.org>

[2] Szegedy, Christian, Vincent Vanhoucke, Sergey Ioffe, Jon Shlens, and Zbigniew Wojna. "Rethinking the inception architecture for computer vision." In *Proceedings of the IEEE Conference on Computer Vision and Pattern Recognition*, pp. 2818-2826. 2016.

[3] <https://keras.io/applications/#inceptionv3>

## Extended Capabilities

### **C/C++ Code Generation**

Generate C and C++ code using MATLAB® Coder™.

For code generation, you can load the network by using the syntax `net = inceptionv3` or by passing the `inceptionv3` function to `coder.loadDeepLearningNetwork`. For example: `net = coder.loadDeepLearningNetwork('inceptionv3')`

For more information, see "Load Pretrained Networks for Code Generation" (MATLAB Coder).

The syntax `inceptionv3('Weights','none')` is not supported for code generation.

### **GPU Code Generation**

Generate CUDA® code for NVIDIA® GPUs using GPU Coder™.

Usage notes and limitations:



- For code generation, you can load the network by using the syntax `net = inceptionv3` or by passing the `inceptionv3` function to `coder.loadDeepLearningNetwork`. For example: `net = coder.loadDeepLearningNetwork('inceptionv3')`.

For more information, see “Load Pretrained Networks for Code Generation” (GPU Coder).

- The syntax `inceptionv3('Weights','none')` is not supported for GPU code generation.

## See Also

[DAGNetwork](#) | [alexnet](#) | [densenet201](#) | [googlenet](#) | [inceptionresnetv2](#) | [layerGraph](#) | [plot](#) | [resnet18](#) | [resnet50](#) | [squeezeNet](#) | [trainNetwork](#) | [vgg16](#) | [vgg19](#)

## Topics

“Deep Learning in MATLAB”

“Pretrained Deep Neural Networks”

“Classify Image Using GoogLeNet”

“Train Deep Learning Network to Classify New Images”

“Train Residual Network for Image Classification”

## Introduced in R2017b

## Layer

Network layer for deep learning

## Description

Layers that define the architecture of neural networks for deep learning.

## Creation

For a list of deep learning layers in MATLAB, see “List of Deep Learning Layers”. To specify the architecture of a neural network with all layers connected sequentially, create an array of layers directly. To specify the architecture of a network where layers can have multiple inputs or outputs, use a `LayerGraph` object.

Alternatively, you can import layers from Caffe, Keras, and ONNX using `importCaffeLayers`, `importKerasLayers`, and `importONNXLayers` respectively.

To learn how to create your own custom layers, see “Define Custom Deep Learning Layers”.

## Object Functions

`trainNetwork` Train neural network for deep learning

## Examples

### Construct Network Architecture

Define a convolutional neural network architecture for classification with one convolutional layer, a ReLU layer, and a fully connected layer.

```
layers = [ ...  
    imageInputLayer([28 28 3])  
    convolution2dLayer([5 5],10)  
    reluLayer  
    fullyConnectedLayer(10)  
    softmaxLayer  
    classificationLayer]
```

```
layers =  
6x1 Layer array with layers:
```

1	''	Image Input	28x28x3 images with 'zerocenter' normalization
2	''	Convolution	10 5x5 convolutions with stride [1 1] and padding [0 0 0 0]
3	''	ReLU	ReLU
4	''	Fully Connected	10 fully connected layer
5	''	Softmax	softmax
6	''	Classification Output	crossentropyex

`layers` is a `Layer` object.

Alternatively, you can create the layers individually and then concatenate them.

```
input = imageInputLayer([28 28 3]);
conv = convolution2dLayer([5 5],10);
relu = reluLayer;
fc = fullyConnectedLayer(10);
sm = softmaxLayer;
co = classificationLayer;
```

```
layers = [ ...
    input
    conv
    relu
    fc
    sm
    co]
```

```
layers =
    6x1 Layer array with layers:
```

1	''	Image Input	28x28x3 images with 'zerocenter' normalization
2	''	Convolution	10 5x5 convolutions with stride [1 1] and padding [0 0]
3	''	ReLU	ReLU
4	''	Fully Connected	10 fully connected layer
5	''	Softmax	softmax
6	''	Classification Output	crossentropyex

### Access Layers and Properties in Layer Array

Define a convolutional neural network architecture for classification with one convolutional layer, a ReLU layer, and a fully connected layer.

```
layers = [ ...
    imageInputLayer([28 28 3])
    convolution2dLayer([5 5],10)
    reluLayer
    fullyConnectedLayer(10)
    softmaxLayer
    classificationLayer];
```

Display the image input layer by selecting the first layer.

```
layers(1)
```

```
ans =
    ImageInputLayer with properties:

        Name: ''
    InputSize: [28 28 3]

Hyperparameters
    DataAugmentation: 'none'
    Normalization: 'zerocenter'
    NormalizationDimension: 'auto'
    Mean: []
```

View the input size of the image input layer.

```
layers(1).InputSize
ans = 1×3
    28    28     3
```

Display the stride for the convolutional layer.

```
layers(2).Stride
ans = 1×2
     1     1
```

Access the bias learn rate factor for the fully connected layer.

```
layers(4).BiasLearnRateFactor
ans = 1
```

### Create Simple DAG Network

Create a simple directed acyclic graph (DAG) network for deep learning. Train the network to classify images of digits. The simple network in this example consists of:

- A main branch with layers connected sequentially.
- A *shortcut connection* containing a single 1-by-1 convolutional layer. Shortcut connections enable the parameter gradients to flow more easily from the output layer to the earlier layers of the network.

Create the main branch of the network as a layer array. The addition layer sums multiple inputs element-wise. Specify the number of inputs for the addition layer to sum. All layers must have names and all names must be unique.

```
layers = [
    imageInputLayer([28 28 1], 'Name', 'input')

    convolution2dLayer(5,16, 'Padding', 'same', 'Name', 'conv_1')
    batchNormalizationLayer('Name', 'BN_1')
    reluLayer('Name', 'relu_1')

    convolution2dLayer(3,32, 'Padding', 'same', 'Stride', 2, 'Name', 'conv_2')
    batchNormalizationLayer('Name', 'BN_2')
    reluLayer('Name', 'relu_2')
    convolution2dLayer(3,32, 'Padding', 'same', 'Name', 'conv_3')
    batchNormalizationLayer('Name', 'BN_3')
    reluLayer('Name', 'relu_3')

    additionLayer(2, 'Name', 'add')

    averagePooling2dLayer(2, 'Stride', 2, 'Name', 'avpool')
    fullyConnectedLayer(10, 'Name', 'fc')
    softmaxLayer('Name', 'softmax')
    classificationLayer('Name', 'classOutput')];
```

Create a layer graph from the layer array. `layerGraph` connects all the layers in `layers` sequentially. Plot the layer graph.

```
lgraph = layerGraph(layers);  
figure  
plot(lgraph)
```

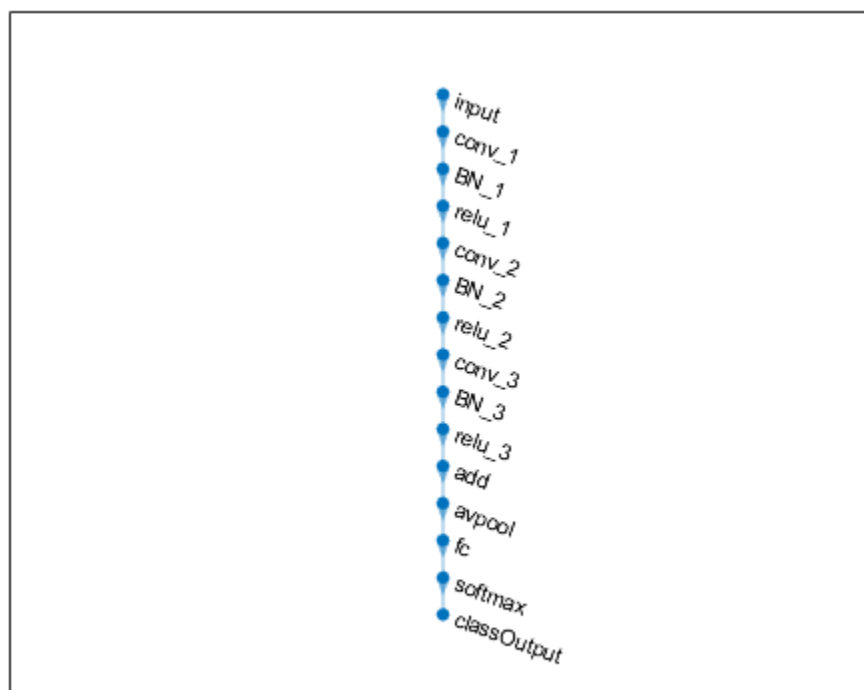

Create the 1-by-1 convolutional layer and add it to the layer graph. Specify the number of convolutional filters and the stride so that the activation size matches the activation size of the 'relu\_3' layer. This arrangement enables the addition layer to add the outputs of the 'skipConv' and 'relu\_3' layers. To check that the layer is in the graph, plot the layer graph.

```
skipConv = convolution2dLayer(1,32,'Stride',2,'Name','skipConv');  
lgraph = addLayers(lgraph,skipConv);  
figure  
plot(lgraph)
```

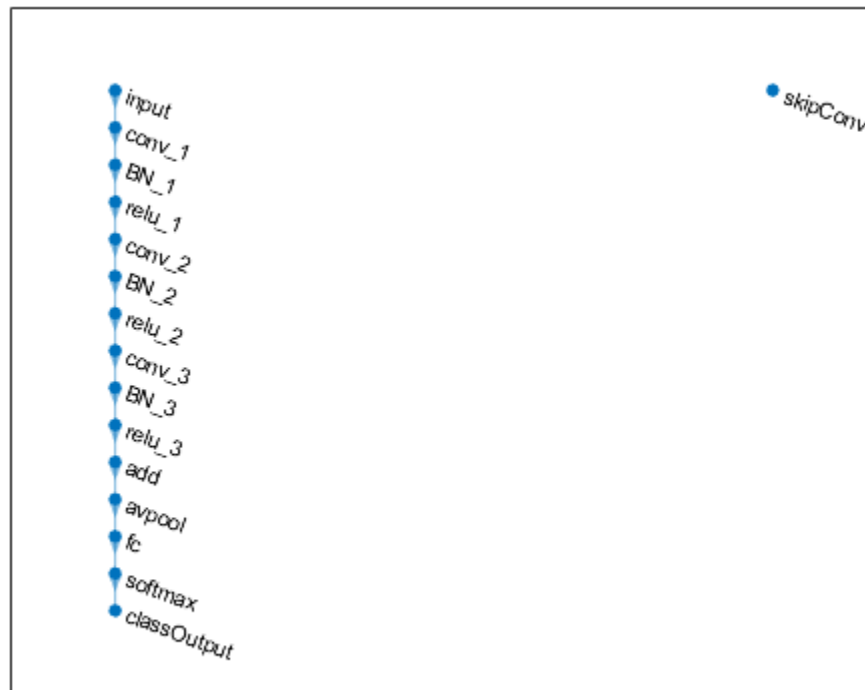

Create the shortcut connection from the 'relu\_1' layer to the 'add' layer. Because you specified two as the number of inputs to the addition layer when you created it, the layer has two inputs named 'in1' and 'in2'. The 'relu\_3' layer is already connected to the 'in1' input. Connect the 'relu\_1' layer to the 'skipConv' layer and the 'skipConv' layer to the 'in2' input of the 'add' layer. The addition layer now sums the outputs of the 'relu\_3' and 'skipConv' layers. To check that the layers are connected correctly, plot the layer graph.

```
lgraph = connectLayers(lgraph, 'relu_1', 'skipConv');  
lgraph = connectLayers(lgraph, 'skipConv', 'add/in2');  
figure  
plot(lgraph);
```

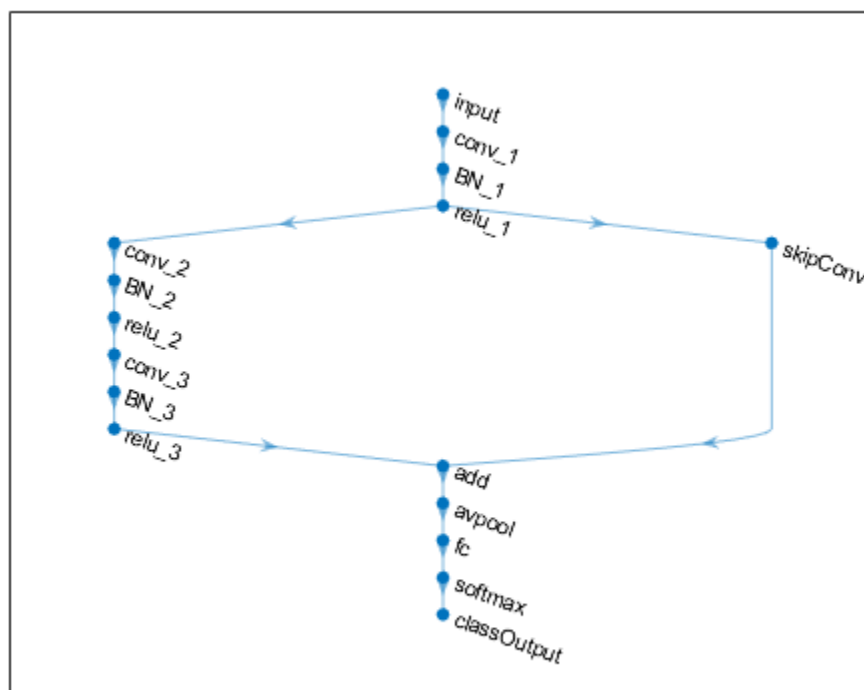

Load the training and validation data, which consists of 28-by-28 grayscale images of digits.

```
[XTrain,YTrain] = digitTrain4DArrayData;
[XValidation,YValidation] = digitTest4DArrayData;
```

Specify training options and train the network. `trainNetwork` validates the network using the validation data every `ValidationFrequency` iterations.

```
options = trainingOptions('sgdm', ...
    'MaxEpochs',8, ...
    'Shuffle','every-epoch', ...
    'ValidationData',{XValidation,YValidation}, ...
    'ValidationFrequency',30, ...
    'Verbose',false, ...
    'Plots','training-progress');
net = trainNetwork(XTrain,YTrain,lgraph,options);
```

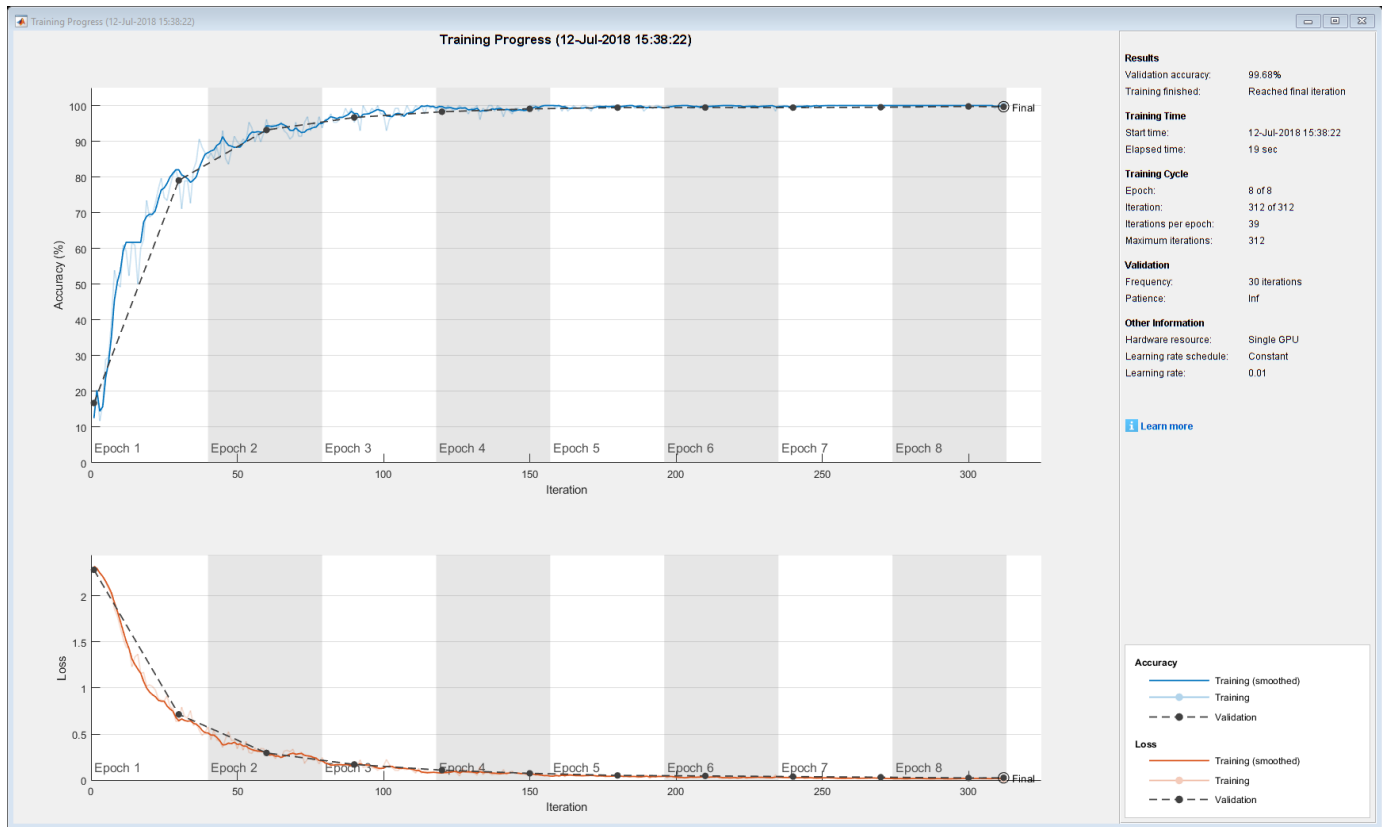

Display the properties of the trained network. The network is a DAGNetwork object.

```
net
```

```
net =
  DAGNetwork with properties:
      Layers: [16x1 nnet.cnn.layer.Layer]
      Connections: [16x2 table]
```

Classify the validation images and calculate the accuracy. The network is very accurate.

```
YPredicted = classify(net,XValidation);
accuracy = mean(YPredicted == YValidation)
```

```
accuracy = 0.9968
```

## See Also

Layer | LayerGraph | assembleNetwork | importCaffeLayers | importKerasLayers | trainNetwork

## Topics

“Create Simple Deep Learning Network for Classification”  
 “Train Convolutional Neural Network for Regression”  
 “Deep Learning in MATLAB”



“Specify Layers of Convolutional Neural Network”

“List of Deep Learning Layers”

“Define Custom Deep Learning Layers”

**Introduced in R2016a**

# layerGraph

Graph of network layers for deep learning

## Description

A layer graph specifies the architecture of a deep learning network with a more complex graph structure in which layers can have inputs from multiple layers and outputs to multiple layers. Networks with this structure are called directed acyclic graph (DAG) networks. After you create a `layerGraph` object, you can use the object functions to plot the graph and modify it by adding, removing, connecting, and disconnecting layers. To train the network, use the layer graph as the `layers` on page 1-0 input argument to `trainNetwork`.

## Creation

### Syntax

```
lgraph = layerGraph
lgraph = layerGraph(layers)
lgraph = layerGraph(dagNet)
lgraph = layerGraph(dlnet)
```

### Description

`lgraph = layerGraph` creates an empty layer graph that contains no layers. You can add layers to the empty graph by using the `addLayers` function.

`lgraph = layerGraph(layers)` creates a layer graph from an array of network layers and sets the `Layers` property. The layers in `lgraph` are connected in the same sequential order as in `layers`. All layers must have unique, nonempty names.

`lgraph = layerGraph(dagNet)` extracts the layer graph of a `DAGNetwork`. For example, you can extract the layer graph of a pretrained network to perform transfer learning.

`lgraph = layerGraph(dlnet)` extracts the layer graph of a `dlnetwork`. Use this syntax to use a `dlnetwork` with the `trainNetwork` function or **Deep Network Designer**.

### Input Arguments

#### **dagNet** — DAG network

`DAGNetwork` object

DAG network, specified as a `DAGNetwork` object.

#### **dlnet** — Network

`dlnetwork` object

Network for custom training loops, specified as a `dlnetwork` object.

For `dlnetwork` input, the software extracts the numeric data from the learnable parameters and converts it to single precision.

## Properties

### Layers — Network layers

Layer array

Network layers, specified as a Layer array.

### Connections — Layer connections

table

Layer connections, specified as a table with two columns.

Each table row represents a connection in the layer graph. The first column, `Source`, specifies the source of each connection. The second column, `Destination`, specifies the destination of each connection. The connection sources and destinations are either layer names or have the form `'layerName/IName'`, where `'IName'` is the name of the layer input or output.

Data Types: table

### InputNames — Network input layer names

cell array

Network input layer names, specified as a cell array of character vectors.

Data Types: cell

### OutputNames — Network output layer names

cell array

Network output layer names, specified as a cell array of character vectors.

Data Types: cell

## Object Functions

<code>addLayers</code>	Add layers to layer graph
<code>removeLayers</code>	Remove layers from layer graph
<code>replaceLayer</code>	Replace layer in layer graph
<code>connectLayers</code>	Connect layers in layer graph
<code>disconnectLayers</code>	Disconnect layers in layer graph
<code>plot</code>	Plot neural network layer graph

## Examples

### Add Layers to Layer Graph

Create an empty layer graph and an array of layers. Add the layers to the layer graph and plot the graph. `addLayers` connects the layers sequentially.

```
lgraph = layerGraph;
```

```
layers = [  
    imageInputLayer([32 32 3], 'Name', 'input')  
    convolution2dLayer(3,16, 'Padding', 'same', 'Name', 'conv_1')  
    batchNormalizationLayer('Name', 'BN_1')  
    reluLayer('Name', 'relu_1')];  
  
lgraph = addLayers(lgraph, layers);  
figure  
plot(lgraph)
```

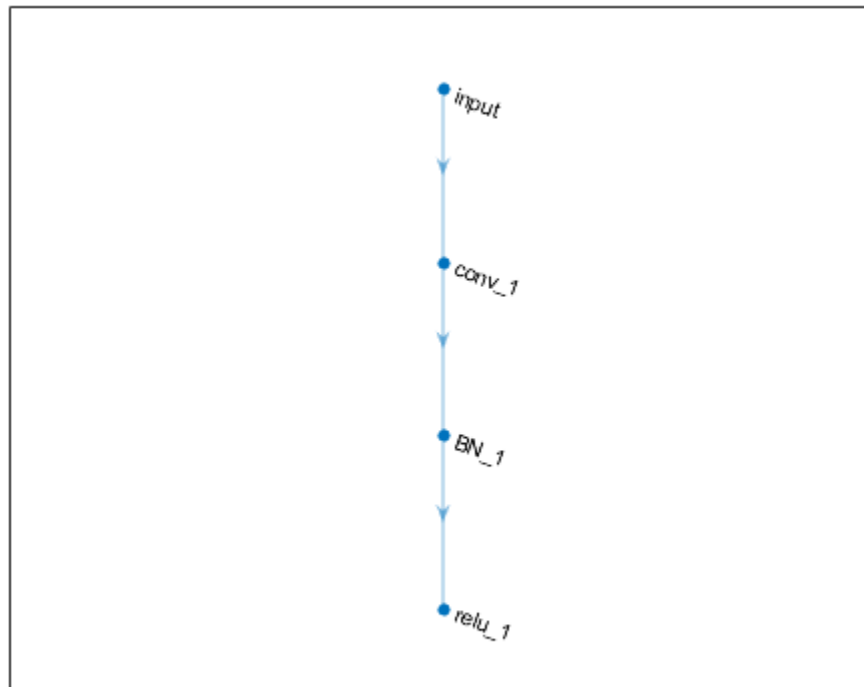

### Create Layer Graph from an Array of Layers

Create an array of layers.

```
layers = [  
    imageInputLayer([28 28 1], 'Name', 'input')  
    convolution2dLayer(3,16, 'Padding', 'same', 'Name', 'conv_1')  
    batchNormalizationLayer('Name', 'BN_1')  
    reluLayer('Name', 'relu_1')];
```

Create a layer graph from the layer array. `layerGraph` connects all the layers in `layers` sequentially. Plot the layer graph.

```
lgraph = layerGraph(layers);
figure
plot(lgraph)
```

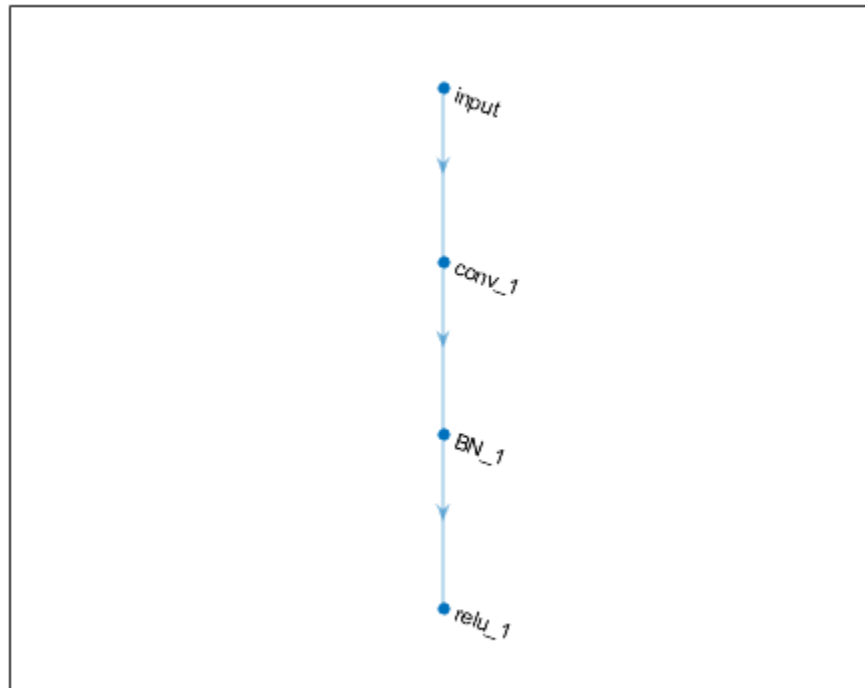

### Extract Layer Graph of DAG Network

Load a pretrained SqueezeNet network. You can use this trained network for classification and prediction.

```
net = squeezeNet;
```

To modify the network structure, first extract the structure of the DAG network by using `layerGraph`. You can then use the object functions of `LayerGraph` to modify the network architecture.

```
lgraph = layerGraph(net)
```

```
lgraph =
```

```
LayerGraph with properties:
```

```

    Layers: [68x1 nnet.cnn.layer.Layer]
Connections: [75x2 table]
  InputNames: {'data'}
OutputNames: {'ClassificationLayer_predictions'}
```

## Create Simple DAG Network

Create a simple directed acyclic graph (DAG) network for deep learning. Train the network to classify images of digits. The simple network in this example consists of:

- A main branch with layers connected sequentially.
- A *shortcut connection* containing a single 1-by-1 convolutional layer. Shortcut connections enable the parameter gradients to flow more easily from the output layer to the earlier layers of the network.

Create the main branch of the network as a layer array. The addition layer sums multiple inputs element-wise. Specify the number of inputs for the addition layer to sum. All layers must have names and all names must be unique.

```
layers = [  
    imageInputLayer([28 28 1], 'Name', 'input')  
  
    convolution2dLayer(5,16, 'Padding', 'same', 'Name', 'conv_1')  
    batchNormalizationLayer('Name', 'BN_1')  
    reluLayer('Name', 'relu_1')  
  
    convolution2dLayer(3,32, 'Padding', 'same', 'Stride', 2, 'Name', 'conv_2')  
    batchNormalizationLayer('Name', 'BN_2')  
    reluLayer('Name', 'relu_2')  
    convolution2dLayer(3,32, 'Padding', 'same', 'Name', 'conv_3')  
    batchNormalizationLayer('Name', 'BN_3')  
    reluLayer('Name', 'relu_3')  
  
    additionLayer(2, 'Name', 'add')  
  
    averagePooling2dLayer(2, 'Stride', 2, 'Name', 'avpool')  
    fullyConnectedLayer(10, 'Name', 'fc')  
    softmaxLayer('Name', 'softmax')  
    classificationLayer('Name', 'classOutput')];
```

Create a layer graph from the layer array. `layerGraph` connects all the layers in `layers` sequentially. Plot the layer graph.

```
lgraph = layerGraph(layers);  
figure  
plot(lgraph)
```

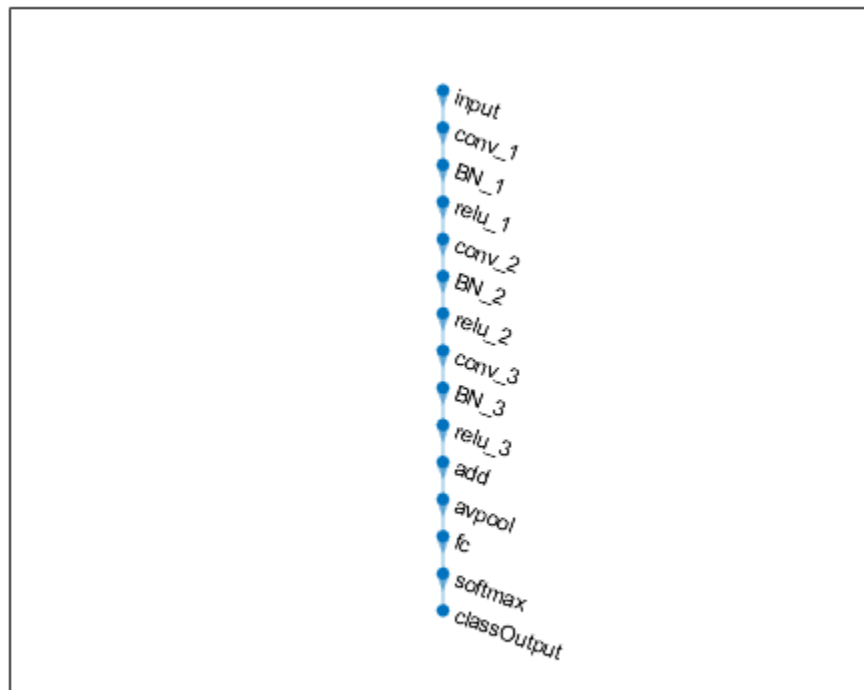

Create the 1-by-1 convolutional layer and add it to the layer graph. Specify the number of convolutional filters and the stride so that the activation size matches the activation size of the 'relu\_3' layer. This arrangement enables the addition layer to add the outputs of the 'skipConv' and 'relu\_3' layers. To check that the layer is in the graph, plot the layer graph.

```
skipConv = convolution2dLayer(1,32,'Stride',2,'Name','skipConv');  
lgraph = addLayers(lgraph,skipConv);  
figure  
plot(lgraph)
```

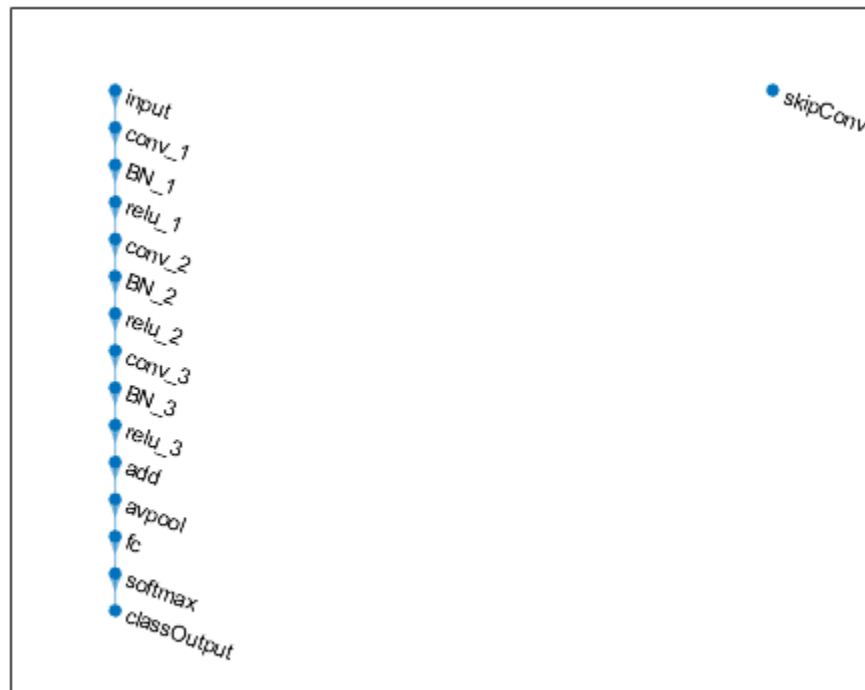

Create the shortcut connection from the 'relu\_1' layer to the 'add' layer. Because you specified two as the number of inputs to the addition layer when you created it, the layer has two inputs named 'in1' and 'in2'. The 'relu\_3' layer is already connected to the 'in1' input. Connect the 'relu\_1' layer to the 'skipConv' layer and the 'skipConv' layer to the 'in2' input of the 'add' layer. The addition layer now sums the outputs of the 'relu\_3' and 'skipConv' layers. To check that the layers are connected correctly, plot the layer graph.

```
lgraph = connectLayers(lgraph, 'relu_1', 'skipConv');  
lgraph = connectLayers(lgraph, 'skipConv', 'add/in2');  
figure  
plot(lgraph);
```



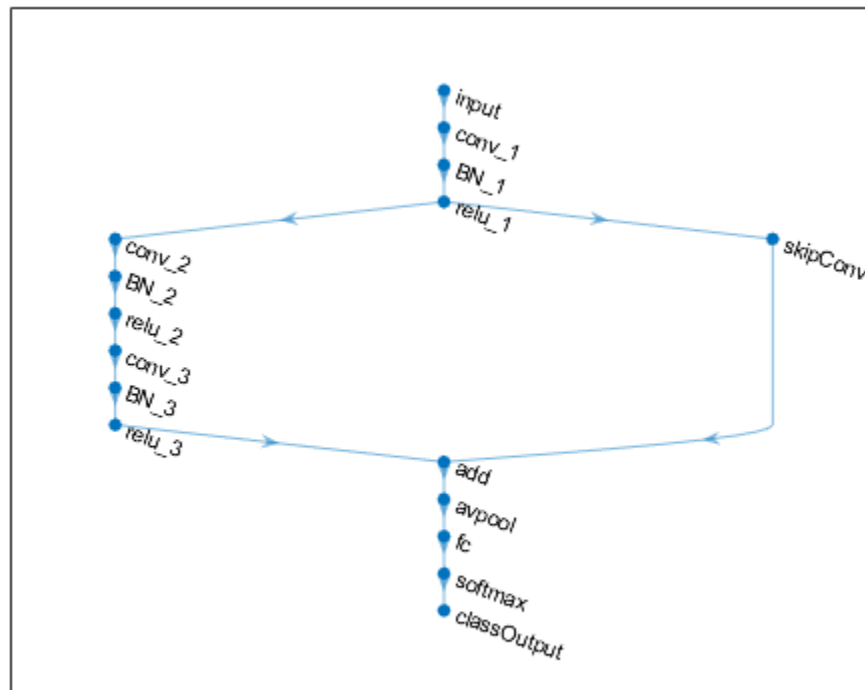

Load the training and validation data, which consists of 28-by-28 grayscale images of digits.

```
[XTrain,YTrain] = digitTrain4DArrayData;
[XValidation,YValidation] = digitTest4DArrayData;
```

Specify training options and train the network. `trainNetwork` validates the network using the validation data every `ValidationFrequency` iterations.

```
options = trainingOptions('sgdm', ...
    'MaxEpochs',8, ...
    'Shuffle','every-epoch', ...
    'ValidationData',{XValidation,YValidation}, ...
    'ValidationFrequency',30, ...
    'Verbose',false, ...
    'Plots','training-progress');
net = trainNetwork(XTrain,YTrain,lgraph,options);
```

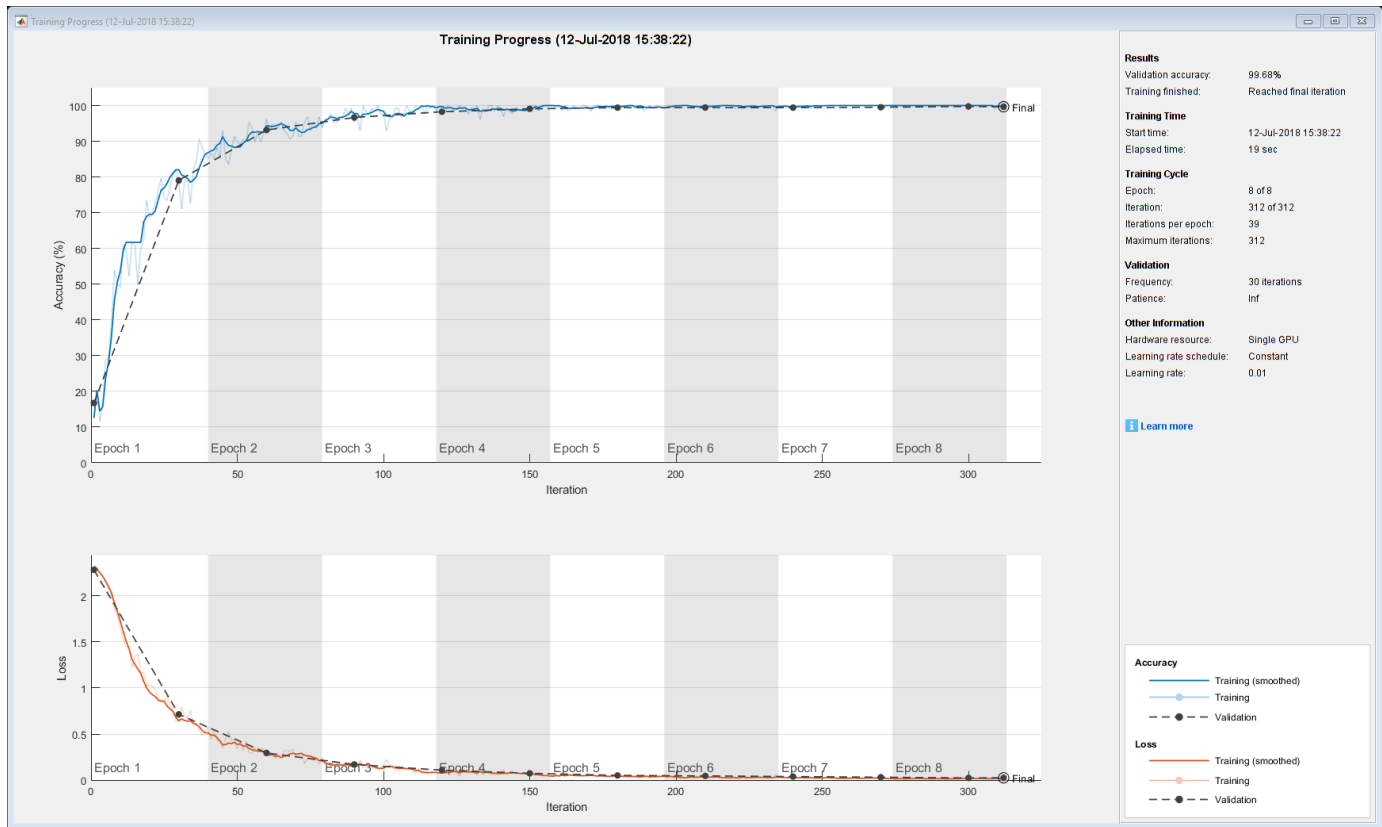

Display the properties of the trained network. The network is a DAGNetwork object.

```
net
```

```
net =
```

```
DAGNetwork with properties:
```

```
Layers: [16x1 nnet.cnn.layer.Layer]
```

```
Connections: [16x2 table]
```

Classify the validation images and calculate the accuracy. The network is very accurate.

```
YPredicted = classify(net,XValidation);  
accuracy = mean(YPredicted == YValidation)
```

```
accuracy = 0.9968
```

## Tips

- Layer graphs cannot specify the architecture of long short-term memory (LSTM) networks. For more information on how to create an LSTM network, see “Long Short-Term Memory Networks”.

## See Also

DAGNetwork | **Deep Network Designer** | addLayers | additionLayer | analyzeNetwork | assembleNetwork | connectLayers | depthConcatenationLayer | disconnectLayers |

googlenet | inceptionresnetv2 | inceptionv3 | plot | removeLayers | replaceLayer |  
resnet101 | resnet18 | resnet50 | squeezenet | trainNetwork

**Topics**

“Create Simple Deep Learning Network for Classification”

“Train Residual Network for Image Classification”

“Train Deep Learning Network to Classify New Images”

“Deep Learning in MATLAB”

“Pretrained Deep Neural Networks”

“List of Deep Learning Layers”

**Introduced in R2017b**

## leakyrelu

Apply leaky rectified linear unit activation

### Syntax

```
dLY = leakyrelu(dlX)
dLY = leakyrelu(dlX, scaleFactor)
```

### Description

The leaky rectified linear unit (ReLU) activation operation performs a nonlinear threshold operation, where any input value less than zero is multiplied by a fixed scale factor.

This operation is equivalent to

$$f(x) = \begin{cases} x, & x \geq 0 \\ scale * x, & x < 0 \end{cases}$$

---

**Note** This function applies the leaky ReLU operation to `dlarray` data. If you want to apply leaky ReLU activation within a `layerGraph` object or `Layer` array, use the following layer:

- `leakyReluLayer`
- 

`dLY = leakyrelu(dlX)` computes the leaky ReLU activation of the input `dlX` by applying a threshold operation. All values in `dlX` less than zero are multiplied by a default scale factor of `0.01`.

`dLY = leakyrelu(dlX, scaleFactor)` specifies the scale factor for the leaky ReLU operation.

### Examples

#### Apply Leaky ReLU Activation

Use the `leakyrelu` function to scale negative values in the input data.

Create the input data as a single observation of random values with a height and width of 12 and 32 channels.

```
height = 12;
width = 12;
channels = 32;
observations = 1;

X = randn(height,width,channels,observations);
dlX = dlarray(X, 'SSCB');
```

Compute the leaky ReLU activation using a scale factor of `0.05` for the negative values in the input.

```
dLY = leakyrelu(dLX,0.05);
```

## Input Arguments

### **dLX — Input data**

dlarray

Input data, specified as a `dlarray` with or without dimension labels.

Data Types: `single` | `double`

### **scaleFactor — Scale factor for negative inputs**

0.01 (default) | numeric scalar

Scale factor for negative inputs, specified as a numeric scalar. The default value is 0.01.

Data Types: `single` | `double`

## Output Arguments

### **dLY — Leaky ReLU activations**

dlarray

Leaky ReLU activations, returned as a `dlarray`. The output `dLY` has the same underlying data type as the input `dLX`.

If the input data `dLX` is a formatted `dlarray`, `dLY` has the same dimension labels as `dLX`. If the input data is not a formatted `dlarray`, `dLY` is an unformatted `dlarray` with the same dimension order as the input data.

## Extended Capabilities

### **GPU Arrays**

Accelerate code by running on a graphics processing unit (GPU) using Parallel Computing Toolbox™.

Usage notes and limitations:

- When the input argument `dLX` is a `gpuArray` or a `dlarray` with underlying data of type `gpuArray`, this function runs on the GPU.

For more information, see “Run MATLAB Functions on a GPU” (Parallel Computing Toolbox).

## See Also

`batchnorm` | `dlarray` | `dlconv` | `dlfeval` | `dlgradient` | `relu`

### **Topics**

“Define Custom Training Loops, Loss Functions, and Networks”

“Train Network Using Model Function”

### **Introduced in R2019b**

# leakyReluLayer

Leaky Rectified Linear Unit (ReLU) layer

## Description

A leaky ReLU layer performs a threshold operation, where any input value less than zero is multiplied by a fixed scalar.

This operation is equivalent to:

$$f(x) = \begin{cases} x, & x \geq 0 \\ scale * x, & x < 0 \end{cases}$$

## Creation

### Syntax

```
layer = leakyReluLayer  
layer = leakyReluLayer(scale)  
layer = leakyReluLayer( ____, 'Name', Name)
```

### Description

`layer = leakyReluLayer` returns a leaky ReLU layer.

`layer = leakyReluLayer(scale)` returns a leaky ReLU layer with a scalar multiplier for negative inputs equal to `scale`.

`layer = leakyReluLayer( ____, 'Name', Name)` returns a leaky ReLU layer and sets the optional `Name` property.

## Properties

### Leaky ReLU

#### Scale — Scalar multiplier for negative input values

0.01 (default) | numeric scalar

Scalar multiplier for negative input values, specified as a numeric scalar.

Example: 0.4

### Layer

#### Name — Layer name

'' (default) | character vector | string scalar

Layer name, specified as a character vector or a string scalar. To include a layer in a layer graph, you must specify a nonempty unique layer name. If you train a series network with the layer and Name is set to ' ', then the software automatically assigns a name to the layer at training time.

Data Types: `char` | `string`

### **NumInputs — Number of inputs**

1 (default)

Number of inputs of the layer. This layer accepts a single input only.

Data Types: `double`

### **InputNames — Input names**

{'in'} (default)

Input names of the layer. This layer accepts a single input only.

Data Types: `cell`

### **NumOutputs — Number of outputs**

1 (default)

Number of outputs of the layer. This layer has a single output only.

Data Types: `double`

### **OutputNames — Output names**

{'out'} (default)

Output names of the layer. This layer has a single output only.

Data Types: `cell`

## **Examples**

### **Create Leaky ReLU Layer**

Create a leaky ReLU layer with the name 'leaky1' and a scalar multiplier for negative inputs equal to 0.1.

```
layer = leakyReluLayer(0.1, 'Name', 'leaky1')
```

```
layer =  
    LeakyReLULayer with properties:
```

```
    Name: 'leaky1'
```

```
    Hyperparameters  
    Scale: 0.1000
```

Include a leaky ReLU layer in a Layer array.

```
layers = [  
    imageInputLayer([28 28 1])  
    convolution2dLayer(3,16)
```

```
batchNormalizationLayer
leakyReluLayer

maxPooling2dLayer(2, 'Stride', 2)
convolution2dLayer(3, 32)
batchNormalizationLayer
leakyReluLayer

fullyConnectedLayer(10)
softmaxLayer
classificationLayer]

layers =
  1x1 Layer array with layers:

   1  ''  Image Input           28x28x1 images with 'zerocenter' normalization
   2  ''  Convolution           16 3x3 convolutions with stride [1 1] and padding [0 0 0 0]
   3  ''  Batch Normalization   Batch normalization
   4  ''  Leaky ReLU            Leaky ReLU with scale 0.01
   5  ''  Max Pooling           2x2 max pooling with stride [2 2] and padding [0 0 0 0]
   6  ''  Convolution           32 3x3 convolutions with stride [1 1] and padding [0 0 0 0]
   7  ''  Batch Normalization   Batch normalization
   8  ''  Leaky ReLU            Leaky ReLU with scale 0.01
   9  ''  Fully Connected       10 fully connected layer
  10  ''  Softmax                softmax
  11  ''  Classification Output  crossentropyex
```

## References

[1] Maas, Andrew L., Awni Y. Hannun, and Andrew Y. Ng. "Rectifier nonlinearities improve neural network acoustic models." In *Proc. ICML*, vol. 30, no. 1. 2013.

## Extended Capabilities

### GPU Code Generation

Generate CUDA® code for NVIDIA® GPUs using GPU Coder™.

## See Also

[clippedReluLayer](#) | [reluLayer](#)

### Topics

["Create Simple Deep Learning Network for Classification"](#)

["Train Convolutional Neural Network for Regression"](#)

["Deep Learning in MATLAB"](#)

["Specify Layers of Convolutional Neural Network"](#)

["List of Deep Learning Layers"](#)

### Introduced in R2017b



# lstm

Long short-term memory

## Syntax

```
dLY = lstm(dLX,H0,C0,weights,recurrentWeights,bias)
[dLY,hiddenState,cellState] = lstm(dLX,H0,C0,weights,recurrentWeights,bias)
[ ___ ] = lstm( ___, 'DataFormat',FMT)
```

## Description

The long short-term memory (LSTM) operation allows a network to learn long-term dependencies between time steps in time series and sequence data.

---

**Note** This function applies the deep learning LSTM operation to `dLarray` data. If you want to apply an LSTM operation within a `layerGraph` object or `Layer` array, use the following layer:

- `lstmLayer`
- 

`dLY = lstm(dLX,H0,C0,weights,recurrentWeights,bias)` applies a long short-term memory (LSTM) calculation to input `dLX` using the initial hidden state `H0`, initial cell state `C0`, and parameters `weights`, `recurrentWeights`, and `bias`. The input `dLX` is a formatted `dLarray` with dimension labels. The output `dLY` is a formatted `dLarray` with the same dimension labels as `dLX`, except for any 'S' dimensions.

The `lstm` function updates the cell and hidden states using the hyperbolic tangent function ( $\tanh$ ) as the state activation function. The `lstm` function uses the sigmoid function given by  $\sigma(x) = (1 + e^{-x})^{-1}$  as the gate activation function.

`[dLY,hiddenState,cellState] = lstm(dLX,H0,C0,weights,recurrentWeights,bias)` also returns the hidden state and cell state after the LSTM operation.

`[ ___ ] = lstm( ___, 'DataFormat',FMT)` also specifies the dimension format `FMT` when `dLX` is not a formatted `dLarray`. The output `dLY` is an unformatted `dLarray` with the same dimension order as `dLX`, except for any 'S' dimensions.

## Examples

### Apply LSTM Operation to Sequence Data

Perform an LSTM operation using three hidden units.

Create the input sequence data as 32 observations with 10 channels and a sequence length of 64

```
numFeatures = 10;
numObservations = 32;
```

```
sequenceLength = 64;
```

```
X = randn(numFeatures,numObservations,sequenceLength);  
dLX = dlarray(X,'CBT');
```

Create the initial hidden and cell states with three hidden units. Use the same initial hidden state and cell state for all observations.

```
numHiddenUnits = 3;  
H0 = zeros(numHiddenUnits,1);  
C0 = zeros(numHiddenUnits,1);
```

Create the learnable parameters for the LSTM operation.

```
weights = dlarray(randn(4*numHiddenUnits,numFeatures),'CU');  
recurrentWeights = dlarray(randn(4*numHiddenUnits,numHiddenUnits),'CU');  
bias = dlarray(randn(4*numHiddenUnits,1),'C');
```

Perform the LSTM calculation

```
[dLY,hiddenState,cellState] = lstm(dLX,H0,C0,weights,recurrentWeights,bias);
```

View the size and dimensions of dLY.

```
size(dLY)
```

```
ans = 1×3
```

```
    3    32    64
```

```
dLY.dims
```

```
ans =  
'CBT'
```

View the size of hiddenState and cellState.

```
size(hiddenState)
```

```
ans = 1×2
```

```
    3    32
```

```
size(cellState)
```

```
ans = 1×2
```

```
    3    32
```

Check that the output hiddenState is the same as the last time step of output dLY.

```
if extractdata(dLY(:,:,end)) == hiddenState  
    disp("The hidden state and the last time step are equal.");  
else  
    disp("The hidden state and the last time step are not equal.")  
end
```

The hidden state and the last time step are equal.

You can use the hidden state and cell state to keep track of the state of the LSTM operation and input further sequential data.

## Input Arguments

### **d $\backslash$ X** — Input data

`d\array` | numeric array

Input data, specified as a `d\array` with or without dimension labels or a numeric array. When `d\X` is not a formatted `d\array`, you must specify the dimension label format using 'DataFormat', `FMT`. If `d\X` is a numeric array, at least one of `H0`, `C0`, `weights`, `recurrentWeights`, or `bias` must be a `d\array`.

`d\X` must contain a sequence dimension labeled 'T'. If `d\X` has any spatial dimensions labeled 'S', they are flattened into the 'C' channel dimensions. If `d\X` has any unspecified dimensions labeled 'U', they must be singleton.

Data Types: `single` | `double`

### **H0** — Initial hidden state vector

`d\array` | numeric array

Initial hidden state vector, specified as a `d\array` with or without dimension labels or a numeric array.

If `H0` is a formatted `d\array`, it must contain a channel dimension labeled 'C' and optionally a batch dimension labeled 'B' with the same size as the 'B' dimension of `d\X`. If `H0` does not have a 'B' dimension, the function uses the same hidden state vector for each observation in `d\X`.

The size of the 'C' dimension determines the number of hidden units. The size of the 'C' dimension of `H0` must be equal to the size of the 'C' dimensions of `C0`.

If `H0` is not a formatted `d\array`, the size of the first dimension determines the number of hidden units and must be the same size as the first dimension or the 'C' dimension of `C0`.

Data Types: `single` | `double`

### **C0** — Initial cell state vector

`d\array` | numeric array

Initial cell state vector, specified as a `d\array` with or without dimension labels or a numeric array.

If `C0` is a formatted `d\array`, it must contain a channel dimension labeled 'C' and optionally a batch dimension labeled 'B' with the same size as the 'B' dimension of `d\X`. If `C0` does not have a 'B' dimension, the function uses the same cell state vector for each observation in `d\X`.

The size of the 'C' dimension determines the number of hidden units. The size of the 'C' dimension of `C0` must be equal to the size of the 'C' dimensions of `H0`.

If `C0` is not a formatted `d\array`, the size of the first dimension determines the number of hidden units and must be the same size as the first dimension or the 'C' dimension of `H0`.

Data Types: `single` | `double`

**weights — Weights**

darray | numeric array

Weights, specified as a darray with or without dimension labels or a numeric array.

Specify `weights` as a matrix of size  $4 \times \text{NumHiddenUnits}$ -by-`InputSize`, where `NumHiddenUnits` is the size of the 'C' dimension of both `C0` and `H0`, and `InputSize` is the size of the 'C' dimension of `dX` multiplied by the size of each 'S' dimension of `dX`, where present.

If `weights` is a formatted darray, it must contain a 'C' dimension of size  $4 \times \text{NumHiddenUnits}$  and a 'U' dimension of size `InputSize`.

Data Types: `single` | `double`

**recurrentWeights — Recurrent weights**

darray | numeric array

Recurrent weights, specified as a darray with or without dimension labels or a numeric array.

Specify `recurrentWeights` as a matrix of size  $4 \times \text{NumHiddenUnits}$ -by-`NumHiddenUnits`, where `NumHiddenUnits` is the size of the 'C' dimension of both `C0` and `H0`.

If `recurrentWeights` is a formatted darray, it must contain a 'C' dimension of size  $4 \times \text{NumHiddenUnits}$  and a 'U' dimension of size `NumHiddenUnits`.

Data Types: `single` | `double`

**bias — Bias**

darray vector | numeric vector

Bias, specified as a darray vector with or without dimension labels or a numeric vector.

Specify `bias` as a vector of length  $4 \times \text{NumHiddenUnits}$ , where `NumHiddenUnits` is the size of the 'C' dimension of both `C0` and `H0`.

If `bias` is a formatted darray, the nonsingleton dimension must be labeled with 'C'.

Data Types: `single` | `double`

**FMT — Dimension order of unformatted data**

char array | string

Dimension order of unformatted input data, specified as the comma-separated pair consisting of 'DataFormat' and a character array or string `FMT` that provides a label for each dimension of the data. Each character in `FMT` must be one of the following:

- 'S' — Spatial
- 'C' — Channel
- 'B' — Batch (for example, samples and observations)
- 'T' — Time (for example, sequences)
- 'U' — Unspecified

You can specify multiple dimensions labeled 'S' or 'U'. You can use the labels 'C', 'B', and 'T' at most once.

You must specify 'DataFormat', `FMT` when the input data `dX` is not a formatted darray.

Example: 'DataFormat', 'SSCB'

Data Types: char | string

## Output Arguments

### **dLY — LSTM output**

darray

LSTM output, returned as a darray. The output dLY has the same underlying data type as the input dLX.

If the input data dLX is a formatted darray, dLY has the same dimension labels as dLX, except for any 'S' dimensions. If the input data is not a formatted darray, dLY is an unformatted darray with the same dimension order as the input data.

The size of the 'C' dimension of dLY is the same as the number of hidden units, specified by the size of the 'C' dimension of H0 or C0.

### **hiddenState — Hidden state vector**

darray | numeric array

Hidden state vector for each observation, returned as a darray or a numeric array with the same data type as H0.

If the input H0 is a formatted darray, then the output hiddenState is a formatted darray with the format 'CB'.

### **cellState — Cell state vector**

darray | numeric array

Cell state vector for each observation, returned as a darray or a numeric array. cellState is returned with the same data type as C0.

If the input C0 is a formatted darray, the output cellState is returned as a formatted darray with the format 'CB'.

## Limitations

- functionToLayerGraph does not support the lstm function. If you use functionToLayerGraph with a function that contains the lstm operation, the resulting LayerGraph contains placeholder layers.

## More About

### **Long Short-Term Memory**

The LSTM operation allows a network to learn long-term dependencies between time steps in time series and sequence data. For more information, see the definition of Long Short-Term Memory Layer on page 1-563 on the lstmLayer reference page.

## Extended Capabilities

### GPU Arrays

Accelerate code by running on a graphics processing unit (GPU) using Parallel Computing Toolbox™.

Usage notes and limitations:

- When at least one of the following input arguments is a `gpuArray` or a `dlarray` with underlying data of type `gpuArray`, this function runs on the GPU:
  - `dlX`
  - `H0`
  - `C0`
  - `weights`
  - `recurrentWeights`
  - `bias`

For more information, see “Run MATLAB Functions on a GPU” (Parallel Computing Toolbox).

### See Also

`dlarray` | `dlfeval` | `dlgradient` | `fullyconnect` | `gru` | `softmax`

### Topics

“Define Custom Training Loops, Loss Functions, and Networks”

“Train Network Using Model Function”

“Sequence-to-Sequence Translation Using Attention”

“Multilabel Text Classification Using Deep Learning”

**Introduced in R2019b**

# IstmLayer

Long short-term memory (LSTM) layer

## Description

An LSTM layer learns long-term dependencies between time steps in time series and sequence data.

The layer performs additive interactions, which can help improve gradient flow over long sequences during training.

## Creation

### Syntax

```
layer = lstmLayer(numHiddenUnits)
layer = lstmLayer(numHiddenUnits,Name,Value)
```

### Description

`layer = lstmLayer(numHiddenUnits)` creates an LSTM layer and sets the `NumHiddenUnits` property.

`layer = lstmLayer(numHiddenUnits,Name,Value)` sets additional `OutputMode`, “Activations” on page 1-550, “State” on page 1-550, “Parameters and Initialization” on page 1-551, “Learn Rate and Regularization” on page 1-553, and `Name` properties using one or more name-value pair arguments. You can specify multiple name-value pair arguments. Enclose each property name in quotes.

## Properties

### LSTM

#### **NumHiddenUnits — Number of hidden units**

positive integer

Number of hidden units (also known as the hidden size), specified as a positive integer.

The number of hidden units corresponds to the amount of information remembered between time steps (the hidden state). The hidden state can contain information from all previous time steps, regardless of the sequence length. If the number of hidden units is too large, then the layer might overfit to the training data. This value can vary from a few dozen to a few thousand.

The hidden state does not limit the number of time steps that are processed in an iteration. To split your sequences into smaller sequences for training, use the `'SequenceLength'` option in `trainingOptions`.

Example: 200

**OutputMode – Format of output**

'sequence' (default) | 'last'

Format of output, specified as one of the following:

- 'sequence' - Output the complete sequence.
- 'last' - Output the last time step of the sequence.

**InputSize – Input size**

'auto' (default) | positive integer

Input size, specified as a positive integer or 'auto'. If InputSize is 'auto', then the software automatically assigns the input size at training time.

Example: 100

**Activations****StateActivationFunction – Activation function to update the cell and hidden state**

'tanh' (default) | 'softsign'

Activation function to update the cell and hidden state, specified as one of the following:

- 'tanh' - Use the hyperbolic tangent function (tanh).
- 'softsign' - Use the softsign function  $\text{softsign}(x) = \frac{x}{1 + |x|}$ .

The layer uses this option as the function  $\sigma_c$  in the calculations to update the cell and hidden state. For more information on how activation functions are used in an LSTM layer, see “Long Short-Term Memory Layer” on page 1-563.**GateActivationFunction – Activation function to apply to the gates**

'sigmoid' (default) | 'hard-sigmoid'

Activation function to apply to the gates, specified as one of the following:

- 'sigmoid' - Use the sigmoid function  $\sigma(x) = (1 + e^{-x})^{-1}$ .
- 'hard-sigmoid' - Use the hard sigmoid function

$$\sigma(x) = \begin{cases} 0 & \text{if } x < -2.5 \\ 0.2x + 0.5 & \text{if } -2.5 \leq x \leq 2.5 \\ 1 & \text{if } x > 2.5 \end{cases}$$

The layer uses this option as the function  $\sigma_g$  in the calculations for the layer gates.**State****CellState – Initial value of cell state**

numeric vector

Initial value of the cell state, specified as a NumHiddenUnits-by-1 numeric vector. This value corresponds to the cell state at time step 0.

After setting this property, calls to the resetState function set the cell state to this value.



**HiddenState — Initial value of the hidden state**

numeric vector

Initial value of the hidden state, specified as a NumHiddenUnits-by-1 numeric vector. This value corresponds to the hidden state at time step 0.

After setting this property, calls to the `resetState` function set the hidden state to this value.

**Parameters and Initialization****InputWeightsInitializer — Function to initialize input weights**

'glorot' (default) | 'he' | 'orthogonal' | 'narrow-normal' | 'zeros' | 'ones' | function handle

Function to initialize the input weights, specified as one of the following:

- 'glorot' - Initialize the input weights with the Glorot initializer [4] (also known as Xavier initializer). The Glorot initializer independently samples from a uniform distribution with zero mean and variance  $2 / (\text{InputSize} + \text{numOut})$ , where  $\text{numOut} = 4 * \text{NumHiddenUnits}$ .
- 'he' - Initialize the input weights with the He initializer [5]. The He initializer samples from a normal distribution with zero mean and variance  $2 / \text{InputSize}$ .
- 'orthogonal' - Initialize the input weights with  $Q$ , the orthogonal matrix given by the QR decomposition of  $Z = QR$  for a random matrix  $Z$  sampled from a unit normal distribution. [6]
- 'narrow-normal' - Initialize the input weights by independently sampling from a normal distribution with zero mean and standard deviation 0.01.
- 'zeros' - Initialize the input weights with zeros.
- 'ones' - Initialize the input weights with ones.
- Function handle - Initialize the input weights with a custom function. If you specify a function handle, then the function must be of the form `weights = func(sz)`, where `sz` is the size of the input weights.

The layer only initializes the input weights when the `InputWeights` property is empty.

Data Types: char | string | function\_handle

**RecurrentWeightsInitializer — Function to initialize recurrent weights**

'orthogonal' (default) | 'glorot' | 'he' | 'narrow-normal' | 'zeros' | 'ones' | function handle

Function to initialize the recurrent weights, specified as one of the following:

- 'orthogonal' - Initialize the recurrent weights with  $Q$ , the orthogonal matrix given by the QR decomposition of  $Z = QR$  for a random matrix  $Z$  sampled from a unit normal distribution. [6]
- 'glorot' - Initialize the recurrent weights with the Glorot initializer [4] (also known as Xavier initializer). The Glorot initializer independently samples from a uniform distribution with zero mean and variance  $2 / (\text{numIn} + \text{numOut})$ , where  $\text{numIn} = \text{NumHiddenUnits}$  and  $\text{numOut} = 4 * \text{NumHiddenUnits}$ .
- 'he' - Initialize the recurrent weights with the He initializer [5]. The He initializer samples from a normal distribution with zero mean and variance  $2 / \text{NumHiddenUnits}$ .
- 'narrow-normal' - Initialize the recurrent weights by independently sampling from a normal distribution with zero mean and standard deviation 0.01.

- 'zeros' - Initialize the recurrent weights with zeros.
- 'ones' - Initialize the recurrent weights with ones.
- Function handle - Initialize the recurrent weights with a custom function. If you specify a function handle, then the function must be of the form `weights = func(sz)`, where `sz` is the size of the recurrent weights.

The layer only initializes the recurrent weights when the `RecurrentWeights` property is empty.

Data Types: `char` | `string` | `function_handle`

### **BiasInitializer — Function to initialize bias**

'unit-forget-gate' (default) | 'narrow-normal' | 'ones' | function handle

Function to initialize the bias, specified as one of the following:

- 'unit-forget-gate' - Initialize the forget gate bias with ones and the remaining biases with zeros.
- 'narrow-normal' - Initialize the bias by independently sampling from a normal distribution with zero mean and standard deviation 0.01.
- 'ones' - Initialize the bias with ones.
- Function handle - Initialize the bias with a custom function. If you specify a function handle, then the function must be of the form `bias = func(sz)`, where `sz` is the size of the bias.

The layer only initializes the bias when the `Bias` property is empty.

Data Types: `char` | `string` | `function_handle`

### **InputWeights — Input weights**

[] (default) | matrix

Input weights, specified as a matrix.

The input weight matrix is a concatenation of the four input weight matrices for the components (gates) in the LSTM layer. The four matrices are concatenated vertically in the following order:

- 1 Input gate
- 2 Forget gate
- 3 Cell candidate
- 4 Output gate

The input weights are learnable parameters. When training a network, if `InputWeights` is nonempty, then `trainNetwork` uses the `InputWeights` property as the initial value. If `InputWeights` is empty, then `trainNetwork` uses the initializer specified by `InputWeightsInitializer`.

At training time, `InputWeights` is a  $4 \times \text{NumHiddenUnits}$ -by-`InputSize` matrix.

### **RecurrentWeights — Recurrent weights**

[] (default) | matrix

Recurrent weights, specified as a matrix.

The recurrent weight matrix is a concatenation of the four recurrent weight matrices for the components (gates) in the LSTM layer. The four matrices are vertically concatenated in the following order:

- 1 Input gate
- 2 Forget gate
- 3 Cell candidate
- 4 Output gate

The recurrent weights are learnable parameters. When training a network, if `RecurrentWeights` is nonempty, then `trainNetwork` uses the `RecurrentWeights` property as the initial value. If `RecurrentWeights` is empty, then `trainNetwork` uses the initializer specified by `RecurrentWeightsInitializer`.

At training time `RecurrentWeights` is a  $4 \times \text{NumHiddenUnits}$ -by- $\text{NumHiddenUnits}$  matrix.

### **Bias — Layer biases**

`[]` (default) | numeric vector

Layer biases for the LSTM layer, specified as a numeric vector.

The bias vector is a concatenation of the four bias vectors for the components (gates) in the LSTM layer. The four vectors are concatenated vertically in the following order:

- 1 Input gate
- 2 Forget gate
- 3 Cell candidate
- 4 Output gate

The layer biases are learnable parameters. When training a network, if `Bias` is nonempty, then `trainNetwork` uses the `Bias` property as the initial value. If `Bias` is empty, then `trainNetwork` uses the initializer specified by `BiasInitializer`.

At training time, `Bias` is a  $4 \times \text{NumHiddenUnits}$ -by-1 numeric vector.

### **Learn Rate and Regularization**

#### **InputWeightsLearnRateFactor — Learning rate factor for input weights**

1 (default) | numeric scalar | 1-by-4 numeric vector

Learning rate factor for the input weights, specified as a numeric scalar or a 1-by-4 numeric vector.

The software multiplies this factor by the global learning rate to determine the learning rate factor for the input weights of the layer. For example, if `InputWeightsLearnRateFactor` is 2, then the learning rate factor for the input weights of the layer is twice the current global learning rate. The software determines the global learning rate based on the settings specified with the `trainingOptions` function.

To control the value of the learning rate factor for the four individual matrices in `InputWeights`, specify a 1-by-4 vector. The entries of `InputWeightsLearnRateFactor` correspond to the learning rate factor of the following:

- 1 Input gate

- 2 Forget gate
- 3 Cell candidate
- 4 Output gate

To specify the same value for all the matrices, specify a nonnegative scalar.

Example: 2

Example: [1 2 1 1]

### **RecurrentWeightsLearnRateFactor — Learning rate factor for recurrent weights**

1 (default) | numeric scalar | 1-by-4 numeric vector

Learning rate factor for the recurrent weights, specified as a numeric scalar or a 1-by-4 numeric vector.

The software multiplies this factor by the global learning rate to determine the learning rate for the recurrent weights of the layer. For example, if `RecurrentWeightsLearnRateFactor` is 2, then the learning rate for the recurrent weights of the layer is twice the current global learning rate. The software determines the global learning rate based on the settings specified with the `trainingOptions` function.

To control the value of the learning rate factor for the four individual matrices in `RecurrentWeights`, specify a 1-by-4 vector. The entries of `RecurrentWeightsLearnRateFactor` correspond to the learning rate factor of the following:

- 1 Input gate
- 2 Forget gate
- 3 Cell candidate
- 4 Output gate

To specify the same value for all the matrices, specify a nonnegative scalar.

Example: 2

Example: [1 2 1 1]

### **BiasLearnRateFactor — Learning rate factor for biases**

1 (default) | nonnegative scalar | 1-by-4 numeric vector

Learning rate factor for the biases, specified as a nonnegative scalar or a 1-by-4 numeric vector.

The software multiplies this factor by the global learning rate to determine the learning rate for the biases in this layer. For example, if `BiasLearnRateFactor` is 2, then the learning rate for the biases in the layer is twice the current global learning rate. The software determines the global learning rate based on the settings specified with the `trainingOptions` function.

To control the value of the learning rate factor for the four individual matrices in `Bias`, specify a 1-by-4 vector. The entries of `BiasLearnRateFactor` correspond to the learning rate factor of the following:

- 1 Input gate
- 2 Forget gate
- 3 Cell candidate

#### 4 Output gate

To specify the same value for all the matrices, specify a nonnegative scalar.

Example: 2

Example: [1 2 1 1]

#### **InputWeightsL2Factor — L2 regularization factor for input weights**

1 (default) | numeric scalar | 1-by-4 numeric vector

L2 regularization factor for the input weights, specified as a numeric scalar or a 1-by-4 numeric vector.

The software multiplies this factor by the global L2 regularization factor to determine the L2 regularization factor for the input weights of the layer. For example, if `InputWeightsL2Factor` is 2, then the L2 regularization factor for the input weights of the layer is twice the current global L2 regularization factor. The software determines the L2 regularization factor based on the settings specified with the `trainingOptions` function.

To control the value of the L2 regularization factor for the four individual matrices in `InputWeights`, specify a 1-by-4 vector. The entries of `InputWeightsL2Factor` correspond to the L2 regularization factor of the following:

- 1 Input gate
- 2 Forget gate
- 3 Cell candidate
- 4 Output gate

To specify the same value for all the matrices, specify a nonnegative scalar.

Example: 2

Example: [1 2 1 1]

#### **RecurrentWeightsL2Factor — L2 regularization factor for recurrent weights**

1 (default) | numeric scalar | 1-by-4 numeric vector

L2 regularization factor for the recurrent weights, specified as a numeric scalar or a 1-by-4 numeric vector.

The software multiplies this factor by the global L2 regularization factor to determine the L2 regularization factor for the recurrent weights of the layer. For example, if `RecurrentWeightsL2Factor` is 2, then the L2 regularization factor for the recurrent weights of the layer is twice the current global L2 regularization factor. The software determines the L2 regularization factor based on the settings specified with the `trainingOptions` function.

To control the value of the L2 regularization factor for the four individual matrices in `RecurrentWeights`, specify a 1-by-4 vector. The entries of `RecurrentWeightsL2Factor` correspond to the L2 regularization factor of the following:

- 1 Input gate
- 2 Forget gate
- 3 Cell candidate

**4** Output gate

To specify the same value for all the matrices, specify a nonnegative scalar.

Example: 2

Example: [1 2 1 1]

**BiasL2Factor — L2 regularization factor for biases**

0 (default) | nonnegative scalar | 1-by-4 numeric vector

L2 regularization factor for the biases, specified as a nonnegative scalar or a 1-by-4 numeric vector.

The software multiplies this factor by the global L2 regularization factor to determine the L2 regularization for the biases in this layer. For example, if `BiasL2Factor` is 2, then the L2 regularization for the biases in this layer is twice the global L2 regularization factor. You can specify the global L2 regularization factor using the `trainingOptions` function.

To control the value of the L2 regularization factor for the four individual matrices in `Bias`, specify a 1-by-4 vector. The entries of `BiasL2Factor` correspond to the L2 regularization factor of the following:

- 1** Input gate
- 2** Forget gate
- 3** Cell candidate
- 4** Output gate

To specify the same value for all the matrices, specify a nonnegative scalar.

Example: 2

Example: [1 2 1 1]

**Layer****Name — Layer name**

' ' (default) | character vector | string scalar

Layer name, specified as a character vector or a string scalar. If `Name` is set to ' ', then the software automatically assigns a name at training time.

Data Types: `char` | `string`

**NumInputs — Number of inputs**

1 (default)

Number of inputs of the layer. This layer accepts a single input only.

Data Types: `double`

**InputNames — Input names**

{'in'} (default)

Input names of the layer. This layer accepts a single input only.

Data Types: `cell`

**NumOutputs — Number of outputs**

1 (default)

Number of outputs of the layer. This layer has a single output only.

Data Types: double

**OutputNames — Output names**

{'out'} (default)

Output names of the layer. This layer has a single output only.

Data Types: cell

**Examples****Create LSTM Layer**

Create an LSTM layer with the name 'lstm1' and 100 hidden units.

```
layer = lstmLayer(100, 'Name', 'lstm1')
```

```
layer =
  LSTMLayer with properties:
      Name: 'lstm1'

  Hyperparameters
      InputSize: 'auto'
      NumHiddenUnits: 100
      OutputMode: 'sequence'
      StateActivationFunction: 'tanh'
      GateActivationFunction: 'sigmoid'

  Learnable Parameters
      InputWeights: []
      RecurrentWeights: []
      Bias: []

  State Parameters
      HiddenState: []
      CellState: []

  Show all properties
```

Include an LSTM layer in a Layer array.

```
inputSize = 12;
numHiddenUnits = 100;
numClasses = 9;

layers = [ ...
  sequenceInputLayer(inputSize)
  lstmLayer(numHiddenUnits)
  fullyConnectedLayer(numClasses)
```

```
softmaxLayer
classificationLayer]

layers =
  5x1 Layer array with layers:

   1  ''  Sequence Input           Sequence input with 12 dimensions
   2  ''  LSTM                     LSTM with 100 hidden units
   3  ''  Fully Connected          9 fully connected layer
   4  ''  Softmax                   softmax
   5  ''  Classification Output    crossentropyex
```

### Train Network for Sequence Classification

Train a deep learning LSTM network for sequence-to-label classification.

Load the Japanese Vowels data set as described in [1] and [2]. `XTrain` is a cell array containing 270 sequences of varying length with a feature dimension of 12. `Y` is a categorical vector of labels 1,2,...,9. The entries in `XTrain` are matrices with 12 rows (one row for each feature) and a varying number of columns (one column for each time step).

```
[XTrain,YTrain] = japaneseVowelsTrainData;
```

Visualize the first time series in a plot. Each line corresponds to a feature.

```
figure
plot(XTrain{1}')
title("Training Observation 1")
numFeatures = size(XTrain{1},1);
legend("Feature " + string(1:numFeatures), 'Location', 'northeastoutside')
```



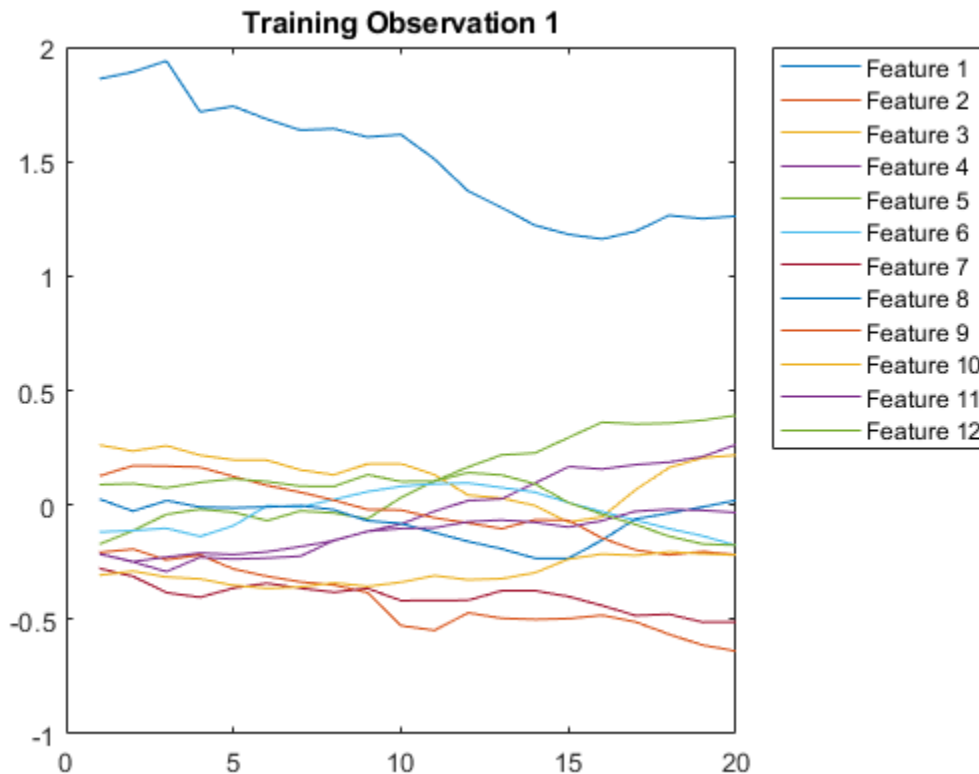

Define the LSTM network architecture. Specify the input size as 12 (the number of features of the input data). Specify an LSTM layer to have 100 hidden units and to output the last element of the sequence. Finally, specify nine classes by including a fully connected layer of size 9, followed by a softmax layer and a classification layer.

```
inputSize = 12;
numHiddenUnits = 100;
numClasses = 9;

layers = [ ...
    sequenceInputLayer(inputSize)
    lstmLayer(numHiddenUnits,'OutputMode','last')
    fullyConnectedLayer(numClasses)
    softmaxLayer
    classificationLayer]
```

```
layers =
    5x1 Layer array with layers:
```

1	''	Sequence Input	Sequence input with 12 dimensions
2	''	LSTM	LSTM with 100 hidden units
3	''	Fully Connected	9 fully connected layer
4	''	Softmax	softmax
5	''	Classification Output	crossentropyex

Specify the training options. Specify the solver as 'adam' and 'GradientThreshold' as 1. Set the mini-batch size to 27 and set the maximum number of epochs to 100.

Because the mini-batches are small with short sequences, the CPU is better suited for training. Set 'ExecutionEnvironment' to 'cpu'. To train on a GPU, if available, set 'ExecutionEnvironment' to 'auto' (the default value).

```
maxEpochs = 100;
miniBatchSize = 27;

options = trainingOptions('adam', ...
    'ExecutionEnvironment','cpu', ...
    'MaxEpochs',maxEpochs, ...
    'MiniBatchSize',miniBatchSize, ...
    'GradientThreshold',1, ...
    'Verbose',false, ...
    'Plots','training-progress');
```

Train the LSTM network with the specified training options.

```
net = trainNetwork(XTrain,YTrain,layers,options);
```

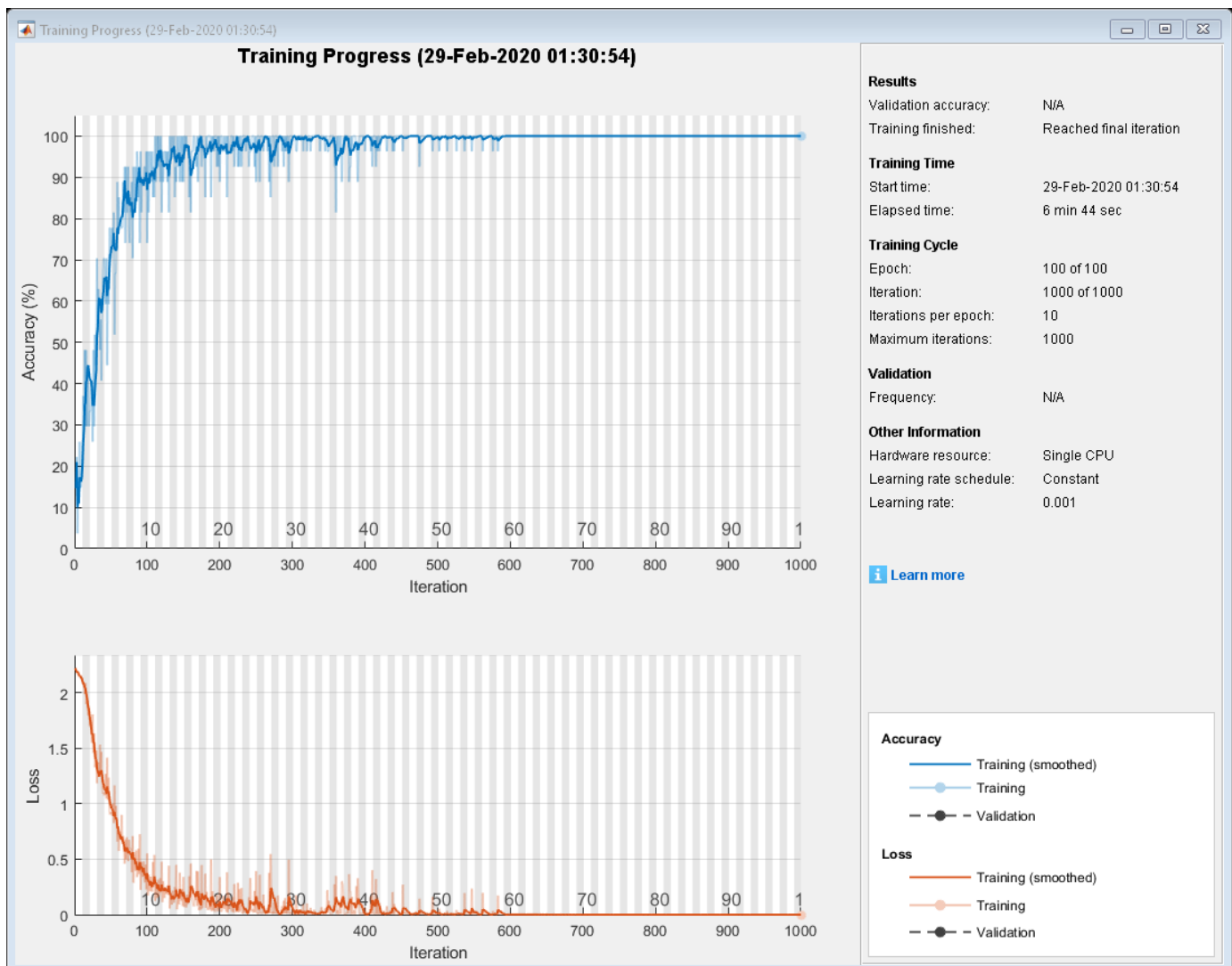

Load the test set and classify the sequences into speakers.

```
[XTest,YTest] = japaneseVowelsTestData;
```

Classify the test data. Specify the same mini-batch size used for training.

```
YPred = classify(net,XTest,'MiniBatchSize',miniBatchSize);
```

Calculate the classification accuracy of the predictions.

```
acc = sum(YPred == YTest)./numel(YTest)
```

```
acc = 0.9486
```

### Classification LSTM Networks

To create an LSTM network for sequence-to-label classification, create a layer array containing a sequence input layer, an LSTM layer, a fully connected layer, a softmax layer, and a classification output layer.

Set the size of the sequence input layer to the number of features of the input data. Set the size of the fully connected layer to the number of classes. You do not need to specify the sequence length.

For the LSTM layer, specify the number of hidden units and the output mode 'last'.

```
numFeatures = 12;
numHiddenUnits = 100;
numClasses = 9;
layers = [ ...
    sequenceInputLayer(numFeatures)
    lstmLayer(numHiddenUnits,'OutputMode','last')
    fullyConnectedLayer(numClasses)
    softmaxLayer
    classificationLayer];
```

For an example showing how to train an LSTM network for sequence-to-label classification and classify new data, see “Sequence Classification Using Deep Learning”.

To create an LSTM network for sequence-to-sequence classification, use the same architecture as for sequence-to-label classification, but set the output mode of the LSTM layer to 'sequence'.

```
numFeatures = 12;
numHiddenUnits = 100;
numClasses = 9;
layers = [ ...
    sequenceInputLayer(numFeatures)
    lstmLayer(numHiddenUnits,'OutputMode','sequence')
    fullyConnectedLayer(numClasses)
    softmaxLayer
    classificationLayer];
```

### Regression LSTM Networks

To create an LSTM network for sequence-to-one regression, create a layer array containing a sequence input layer, an LSTM layer, a fully connected layer, and a regression output layer.

Set the size of the sequence input layer to the number of features of the input data. Set the size of the fully connected layer to the number of responses. You do not need to specify the sequence length.

For the LSTM layer, specify the number of hidden units and the output mode 'last'.

```
numFeatures = 12;
numHiddenUnits = 125;
numResponses = 1;

layers = [ ...
    sequenceInputLayer(numFeatures)
    lstmLayer(numHiddenUnits, 'OutputMode', 'last')
    fullyConnectedLayer(numResponses)
    regressionLayer];
```

To create an LSTM network for sequence-to-sequence regression, use the same architecture as for sequence-to-one regression, but set the output mode of the LSTM layer to 'sequence'.

```
numFeatures = 12;
numHiddenUnits = 125;
numResponses = 1;

layers = [ ...
    sequenceInputLayer(numFeatures)
    lstmLayer(numHiddenUnits, 'OutputMode', 'sequence')
    fullyConnectedLayer(numResponses)
    regressionLayer];
```

For an example showing how to train an LSTM network for sequence-to-sequence regression and predict on new data, see “Sequence-to-Sequence Regression Using Deep Learning”.

### Deeper LSTM Networks

You can make LSTM networks deeper by inserting extra LSTM layers with the output mode 'sequence' before the LSTM layer. To prevent overfitting, you can insert dropout layers after the LSTM layers.

For sequence-to-label classification networks, the output mode of the last LSTM layer must be 'last'.

```
numFeatures = 12;
numHiddenUnits1 = 125;
numHiddenUnits2 = 100;
numClasses = 9;
layers = [ ...
    sequenceInputLayer(numFeatures)
    lstmLayer(numHiddenUnits1, 'OutputMode', 'sequence')
    dropoutLayer(0.2)
    lstmLayer(numHiddenUnits2, 'OutputMode', 'last')
    dropoutLayer(0.2)
    fullyConnectedLayer(numClasses)
    softmaxLayer
    classificationLayer];
```

For sequence-to-sequence classification networks, the output mode of the last LSTM layer must be 'sequence'.

```

numFeatures = 12;
numHiddenUnits1 = 125;
numHiddenUnits2 = 100;
numClasses = 9;
layers = [ ...
    sequenceInputLayer(numFeatures)
    lstmLayer(numHiddenUnits1, 'OutputMode', 'sequence')
    dropoutLayer(0.2)
    lstmLayer(numHiddenUnits2, 'OutputMode', 'sequence')
    dropoutLayer(0.2)
    fullyConnectedLayer(numClasses)
    softmaxLayer
    classificationLayer];

```

## More About

### Long Short-Term Memory Layer

An LSTM layer learns long-term dependencies between time steps in time series and sequence data.

The state of the layer consists of the *hidden state* (also known as the *output state*) and the *cell state*. The hidden state at time step  $t$  contains the output of the LSTM layer for this time step. The cell state contains information learned from the previous time steps. At each time step, the layer adds information to or removes information from the cell state. The layer controls these updates using *gates*.

The following components control the cell state and hidden state of the layer.

Component	Purpose
Input gate ( $i$ )	Control level of cell state update
Forget gate ( $f$ )	Control level of cell state reset (forget)
Cell candidate ( $g$ )	Add information to cell state
Output gate ( $o$ )	Control level of cell state added to hidden state

This diagram illustrates the flow of data at time step  $t$ . The diagram highlights how the gates forget, update, and output the cell and hidden states.

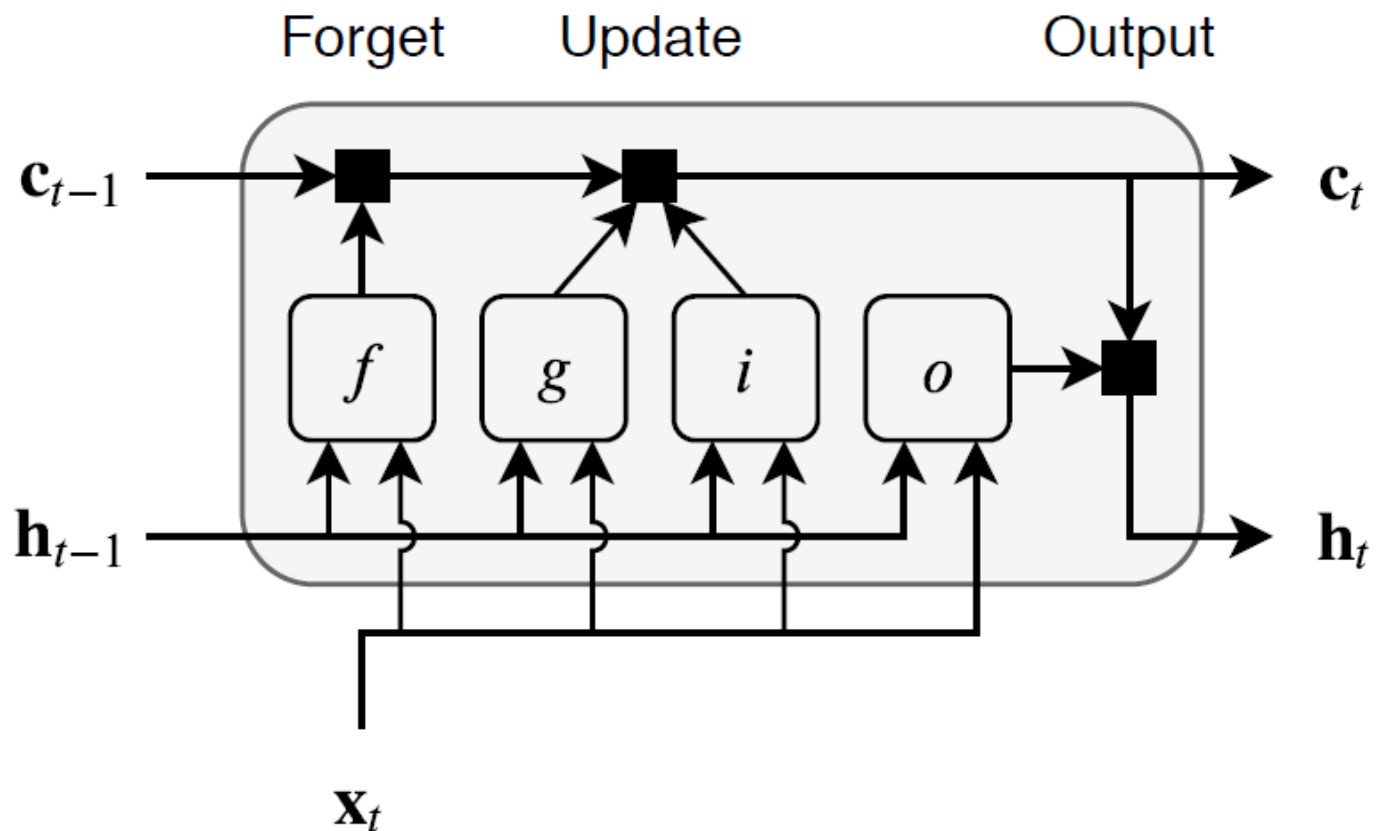

The learnable weights of an LSTM layer are the input weights  $W$  (InputWeights), the recurrent weights  $R$  (RecurrentWeights), and the bias  $b$  (Bias). The matrices  $W$ ,  $R$ , and  $b$  are concatenations of the input weights, the recurrent weights, and the bias of each component, respectively. These matrices are concatenated as follows:

$$W = \begin{bmatrix} W_i \\ W_f \\ W_g \\ W_o \end{bmatrix}, R = \begin{bmatrix} R_i \\ R_f \\ R_g \\ R_o \end{bmatrix}, b = \begin{bmatrix} b_i \\ b_f \\ b_g \\ b_o \end{bmatrix},$$

where  $i$ ,  $f$ ,  $g$ , and  $o$  denote the input gate, forget gate, cell candidate, and output gate, respectively.

The cell state at time step  $t$  is given by

$$\mathbf{c}_t = f_t \odot \mathbf{c}_{t-1} + i_t \odot g_t,$$

where  $\odot$  denotes the Hadamard product (element-wise multiplication of vectors).

The hidden state at time step  $t$  is given by

$$\mathbf{h}_t = o_t \odot \sigma_c(\mathbf{c}_t),$$

where  $\sigma_c$  denotes the state activation function. The `lstmLayer` function, by default, uses the hyperbolic tangent function (`tanh`) to compute the state activation function.

The following formulas describe the components at time step  $t$ .

Component	Formula
Input gate	$i_t = \sigma_g(W_i \mathbf{x}_t + R_i \mathbf{h}_{t-1} + b_i)$
Forget gate	$f_t = \sigma_g(W_f \mathbf{x}_t + R_f \mathbf{h}_{t-1} + b_f)$
Cell candidate	$g_t = \sigma_c(W_g \mathbf{x}_t + R_g \mathbf{h}_{t-1} + b_g)$
Output gate	$o_t = \sigma_g(W_o \mathbf{x}_t + R_o \mathbf{h}_{t-1} + b_o)$

In these calculations,  $\sigma_g$  denotes the gate activation function. The `lstmLayer` function, by default, uses the sigmoid function given by  $\sigma(x) = (1 + e^{-x})^{-1}$  to compute the gate activation function.

## Compatibility Considerations

### Default input weights initialization is Glorot

*Behavior changed in R2019a*

Starting in R2019a, the software, by default, initializes the layer input weights of this layer using the Glorot initializer. This behavior helps stabilize training and usually reduces the training time of deep networks.

In previous releases, the software, by default, initializes the layer input weights using the by sampling from a normal distribution with zero mean and variance 0.01. To reproduce this behavior, set the 'InputWeightsInitializer' option of the layer to 'narrow-normal'.

### Default recurrent weights initialization is orthogonal

*Behavior changed in R2019a*

Starting in R2019a, the software, by default, initializes the layer recurrent weights of this layer with  $Q$ , the orthogonal matrix given by the QR decomposition of  $Z = QR$  for a random matrix  $Z$  sampled from a unit normal distribution. This behavior helps stabilize training and usually reduces the training time of deep networks.

In previous releases, the software, by default, initializes the layer recurrent weights using the by sampling from a normal distribution with zero mean and variance 0.01. To reproduce this behavior, set the 'RecurrentWeightsInitializer' option of the layer to 'narrow-normal'.

## References

- [1] M. Kudo, J. Toyama, and M. Shimbo. "Multidimensional Curve Classification Using Passing-Through Regions." *Pattern Recognition Letters*. Vol. 20, No. 11-13, pages 1103-1111.
- [2] *UCI Machine Learning Repository: Japanese Vowels Dataset*. <https://archive.ics.uci.edu/ml/datasets/Japanese+Vowels>
- [3] Hochreiter, S, and J. Schmidhuber, 1997. Long short-term memory. *Neural computation*, 9(8), pp.1735-1780.
- [4] Glorot, Xavier, and Yoshua Bengio. "Understanding the difficulty of training deep feedforward neural networks." In *Proceedings of the thirteenth international conference on artificial intelligence and statistics*, pp. 249-256. 2010.

- [5] He, Kaiming, Xiangyu Zhang, Shaoqing Ren, and Jian Sun. "Delving deep into rectifiers: Surpassing human-level performance on imagenet classification." In *Proceedings of the IEEE international conference on computer vision*, pp. 1026-1034. 2015.
- [6] Saxe, Andrew M., James L. McClelland, and Surya Ganguli. "Exact solutions to the nonlinear dynamics of learning in deep linear neural networks." *arXiv preprint arXiv:1312.6120* (2013).

## Extended Capabilities

### GPU Code Generation

Generate CUDA® code for NVIDIA® GPUs using GPU Coder™.

Usage notes and limitations:

- For code generation, the `StateActivationFunction` property must be set to `'tanh'`.
- For code generation, the `GateActivationFunction` property must be set to `'sigmoid'`.

### See Also

**Deep Network Designer** | `bilstmLayer` | `classifyAndUpdateState` | `flattenLayer` | `gruLayer` | `predictAndUpdateState` | `resetState` | `sequenceFoldingLayer` | `sequenceInputLayer` | `sequenceUnfoldingLayer`

### Topics

"Sequence Classification Using Deep Learning"  
"Time Series Forecasting Using Deep Learning"  
"Sequence-to-Sequence Classification Using Deep Learning"  
"Sequence-to-Sequence Regression Using Deep Learning"  
"Classify Videos Using Deep Learning"  
"Visualize Activations of LSTM Network"  
"Long Short-Term Memory Networks"  
"Compare Layer Weight Initializers"  
"Deep Learning in MATLAB"  
"List of Deep Learning Layers"

### Introduced in R2017b



# maxpool

Pool data to maximum value

## Syntax

```
dLY = maxpool(dlX, poolsize)
[dLY, indx, inputSize] = maxpool(dlX, poolsize)
___ = maxpool( ___, Name, Value)
dLY = maxpool(dlX, 'global')
___ = maxpool( ___, 'DataFormat', FMT)
```

## Description

The maximum pooling operation performs downsampling by dividing the input into pooling regions and computing the maximum value of each region.

---

**Note** This function applies the maximum pooling operation to `darray` data. If you want to apply maximum pooling within a `layerGraph` object or `Layer` array, use one of the following layers:

- `maxPooling2dLayer`
  - `maxPooling3dLayer`
- 

`dLY = maxpool(dlX, poolsize)` performs downsampling by dividing the input `dlX` into rectangular or cuboidal regions defined by `poolsize` and computing the maximum value of the data in each region. The input `dlX` is a formatted `darray` with dimension labels. Pooling acts on spatial dimensions labeled 'S'. The output `dLY` is a formatted `darray` with the same dimension labels as `dlX`.

`[dLY, indx, inputSize] = maxpool(dlX, poolsize)` also returns the linear indices of the maximum value within each pooled region and the size of the input feature map `dlX` for use with the `maxunpool` operation.

`___ = maxpool( ___, Name, Value)` specifies options using one or more name-value pair arguments. For example, `'Stride', 3` sets the stride of the pooling operation.

`dLY = maxpool(dlX, 'global')` computes the global maximum over the spatial dimensions of the input `dlX`. This syntax is equivalent to setting `poolsize` in the previous syntaxes to the size of the 'S' dimensions of `dlX`.

`___ = maxpool( ___, 'DataFormat', FMT)` also specifies the dimension format `FMT` when `dlX` is not a formatted `darray`, in addition to the input arguments in previous syntaxes. The output `dLY` is an unformatted `darray` with the same dimension order as `dlX`.

## Examples

### Pool Data to Maximum Values

Pool data to maximum values over two spatial dimensions.

Create the input data as a single observation of random values with a height and width of six and a single channel.

```
height = 6;  
width = 6;  
channels = 1;  
observations = 1;
```

```
X = rand(height,width,channels,observations);  
dLX = dLarray(X, 'SSCB')
```

```
dLX =  
  6(S) × 6(S) × 1(C) × 1(B) dLarray  
  
  0.1781    0.8819    0.1564    0.4820    0.2518    0.7302  
  0.1280    0.6692    0.8555    0.1206    0.2904    0.3439  
  0.9991    0.1904    0.6448    0.5895    0.6171    0.5841  
  0.1711    0.3689    0.3763    0.2262    0.2653    0.1078  
  0.0326    0.4607    0.1909    0.3846    0.8244    0.9063  
  0.5612    0.9816    0.4283    0.5830    0.9827    0.8797
```

Pool the data to maximum values over pooling regions of size 2 using a stride of 2.

```
dLY = maxpool(dLX,2, 'Stride',2)
```

```
dLY =  
  3(S) × 3(S) × 1(C) × 1(B) dLarray  
  
  0.8819    0.8555    0.7302  
  0.9991    0.6448    0.6171  
  0.9816    0.5830    0.9827
```

### Pool Data to Global Maximum Value

Pool data to its global maximum value.

Create the input data as an unformatted dLarray. The data contains a single observation of random values with a height of four, a width of six, and a single channel.

```
height = 4;  
width = 6;  
channels = 1;  
observations = 1;
```

```
X = rand(height,width,channels,observations);  
dLX = dLarray(X)
```

```
dLX =  
  4×6 dLarray  
  
  0.8147    0.6324    0.9575    0.9572    0.4218    0.6557  
  0.9058    0.0975    0.9649    0.4854    0.9157    0.0357
```

```

0.1270    0.2785    0.1576    0.8003    0.7922    0.8491
0.9134    0.5469    0.9706    0.1419    0.9595    0.9340

```

Pool the data to the global maximum value. Specify the dimension format of the input data.

```
d1Y = maxpool(d1X, 'global', 'DataFormat', 'SSCB')
```

```

d1Y =
    1×1 d1array
    0.9706

```

## Input Arguments

### d1X — Input data

d1array

Input data, specified as a `d1array` with or without dimension labels. When `d1X` is not a formatted `d1array`, you must specify the dimension label format using `'DataFormat'`, `FMT`.

Pooling acts on dimensions that you specify as spatial dimensions using the `'S'` dimension label. `d1X` must have at least one `'S'` dimension. You can specify up to three dimensions in `d1X` as `'S'` dimensions. The `maxpool` operation divides the data along each `'S'` dimension into regions defined by `poolsize`. The function computes the maximum of all values within each pooling region.

Data Types: `single` | `double`

### poolsize — Size of pooling regions

numeric scalar | numeric vector

Size of the pooling regions, specified as a numeric scalar or numeric vector. If you specify `poolsize` as a scalar, the pooling regions have the same size along all spatial dimensions. To use rectangular or cuboidal pooling regions that have different sizes along each spatial dimension, specify `poolsize` as a vector with the same length as the number of spatial dimensions.

Example: 3

Data Types: `single` | `double`

### Name-Value Pair Arguments

Specify optional comma-separated pairs of `Name`, `Value` arguments. `Name` is the argument name and `Value` is the corresponding value. `Name` must appear inside quotes. You can specify several name and value pair arguments in any order as `Name1, Value1, ..., NameN, ValueN`.

Example: `'Stride', 2` specifies the stride of the pooling regions as 2.

### DataFormat — Dimension order of unformatted data

char array | string

Dimension order of unformatted input data, specified as the comma-separated pair consisting of `'DataFormat'` and a character array or string `FMT` that provides a label for each dimension of the data. Each character in `FMT` must be one of the following:

- `'S'` — Spatial
- `'C'` — Channel

- 'B' — Batch (for example, samples and observations)
- 'T' — Time (for example, sequences)
- 'U' — Unspecified

You can specify multiple dimensions labeled 'S' or 'U'. You can use the labels 'C', 'B', and 'T' at most once.

You must specify 'DataFormat' when the input data `dLX` is not a formatted `dLarray`.

Example: 'DataFormat', 'SSCB'

Data Types: `char` | `string`

### **Stride — Step size for traversing input data**

1 (default) | numeric scalar | numeric vector

Step size for traversing the input data, specified as the comma-separated pair consisting of 'Stride' and a numeric scalar or numeric vector. If you specify 'Stride' as a scalar, the same value is used for all spatial dimensions. If you specify 'Stride' as a vector of the same size as the number of spatial dimensions of the input data, the vector values are used for the corresponding spatial dimensions.

The default value of 'Stride' is 1. If 'Stride' is less than `poolsize` in any dimension, then the pooling regions overlap.

The `Stride` parameter is not supported for global pooling using the 'global' option.

Example: 'Stride', 3

Data Types: `single` | `double`

### **Padding — Padding applied to edges of data**

0 (default) | 'same' | numeric scalar | numeric vector | numeric matrix

Padding applied to edges of data, specified as the comma-separated pair consisting of 'Padding' and one of the following:

- 'same' — Padding is set so that the output size is the same as the input size when the stride is 1. More generally, the output size of each spatial dimension is  $\text{ceil}(\text{inputSize}/\text{stride})$ , where `inputSize` is the size of the input along a spatial dimension.
- Numeric scalar — The same padding value is applied to both ends of all spatial dimensions.
- Numeric vector — A different padding value is applied along each spatial dimension. Use a vector of size `d`, where `d` is the number of spatial dimensions of the input data. The `i`th element of the vector specifies the padding applied to the start and the end along the `i`th spatial dimension.
- Numeric matrix — A different padding value is applied to the start and end of each spatial dimension. Use a matrix of size 2-by-`d`, where `d` is the number of spatial dimensions of the input data. The element  $(1, d)$  specifies the padding applied to the start of spatial dimension `d`. The element  $(2, d)$  specifies the padding applied to the end of spatial dimension `d`. For example, in 2-D, the format is `[top, left; bottom, right]`.

The default value of 'Padding' is 0.

The 'Padding' parameter is not supported for global pooling using the 'global' option.

Example: 'Padding', 'same'

Data Types: `single` | `double`

## Output Arguments

### **dLY — Pooled data**

`dLarray`

Pooled data, returned as a `dLarray`. The output `dLY` has the same underlying data type as the input `dLX`.

If the input data `dLX` is a formatted `dLarray`, `dLY` has the same dimension labels as `dLX`. If the input data is not a formatted `dLarray`, `dLY` is an unformatted `dLarray` with the same dimension order as the input data.

### **indx — Indices of maximum values**

`dLarray`

Indices of maximum values in each pooled region, returned as a `dLarray`. Each value in `indx` represents the location of the corresponding maximum value in `dLY`, given as a linear index of the values in `dLX`.

If `dLX` is a formatted `dLarray`, `indx` has the same size and format as the output `dLY`.

If `dLX` is not a formatted `dLarray`, `indx` is an unformatted `dLarray`. In that case, `indx` is returned with the following dimension order: all 'S' dimensions, followed by 'C', 'B', and 'T' dimensions, then all 'U' dimensions. The size of `indx` matches the size of `dLY` when `dLY` is permuted to match the previously stated dimension order.

Use the `indx` output with the `maxunpool` function to unpool the output of `maxpool`.

`indx` output is not supported when using the 'global' option.

### **inputSize — Size of input feature map**

numeric vector

Size of the input feature map, returned as a numeric vector.

Use the `inputSize` output with the `maxunpool` function to unpool the output of `maxpool`.

`inputSize` output is not supported when using the 'global' option.

## More About

### **Maximum Pooling**

The `maxpool` function pools the input data to maximum values over the spatial dimensions. For more information, see the definition of “Max Pooling Layer” on page 1-579 on the `maxPooling2dLayer` reference page.

## Compatibility Considerations

### **maxpool indices output argument changes shape and data type**

*Behavior changed in R2020a*

Starting in R2020a, the data type and shape of the indices output argument of the `maxpool` function are changed. The `maxpool` function outputs the indices of the maximum values as a `darray` with the same shape and format as the pooled data, instead of a numeric vector.

The indices output of `maxpool` remains compatible with the indices input of `maxunpool`. The `maxunpool` function accepts the indices of the maximum values as a `darray` with the same shape and format as the input data. To prevent errors, use only the indices output of the `maxpool` function as the indices input to the `maxunpool` function.

To reproduce the previous behavior and obtain the indices output as a numeric vector, use the following code:

```
[dY,indx,inputSize] = maxpool(dY,poolsize);  
indx = extractdata(indx);  
indx = reshape(indx,[],1);
```

## Extended Capabilities

### GPU Arrays

Accelerate code by running on a graphics processing unit (GPU) using Parallel Computing Toolbox™.

Usage notes and limitations:

- When the input argument `dX` is a `darray` with underlying data of type `gpuArray`, this function runs on the GPU.

For more information, see “Run MATLAB Functions on a GPU” (Parallel Computing Toolbox).

## See Also

`avgpool` | `darray` | `dlconv` | `dlfeval` | `dlgradient` | `maxunpool`

### Topics

“Define Custom Training Loops, Loss Functions, and Networks”

“Train Network Using Model Function”

### Introduced in R2019b

# maxPooling2dLayer

Max pooling layer

## Description

A max pooling layer performs down-sampling by dividing the input into rectangular pooling regions, and computing the maximum of each region.

## Creation

### Syntax

```
layer = maxPooling2dLayer(poolSize)
layer = maxPooling2dLayer(poolSize,Name,Value)
```

### Description

`layer = maxPooling2dLayer(poolSize)` creates a max pooling layer and sets the `PoolSize` property.

`layer = maxPooling2dLayer(poolSize,Name,Value)` sets the optional `Stride`, `Name`, and `HasUnpoolingOutputs` properties using name-value pairs. To specify input padding, use the `'Padding'` name-value pair argument. For example, `maxPooling2dLayer(2,'Stride',3)` creates a max pooling layer with pool size `[2 2]` and stride `[3 3]`. You can specify multiple name-value pairs. Enclose each property name in single quotes.

### Input Arguments

#### Name-Value Pair Arguments

Use comma-separated name-value pair arguments to specify the size of the padding to add along the edges of the layer input and to set the `Stride`, `Name`, and `HasUnpoolingOutputs` properties. Enclose names in single quotes.

Example: `maxPooling2dLayer(2,'Stride',3)` creates a max pooling layer with pool size `[2 2]` and stride `[3 3]`.

#### Padding — Input edge padding

`[0 0 0 0]` (default) | vector of nonnegative integers | `'same'`

Input edge padding, specified as the comma-separated pair consisting of `'Padding'` and one of these values:

- `'same'` — Add padding of size calculated by the software at training or prediction time so that the output has the same size as the input when the stride equals 1. If the stride is larger than 1, then the output size is `ceil(inputSize/stride)`, where `inputSize` is the height or width of the input and `stride` is the stride in the corresponding dimension. The software adds the same amount of padding to the top and bottom, and to the left and right, if possible. If the padding that must be added vertically has an odd value, then the software adds extra padding to the bottom. If

the padding that must be added horizontally has an odd value, then the software adds extra padding to the right.

- Nonnegative integer `p` — Add padding of size `p` to all the edges of the input.
- Vector `[a b]` of nonnegative integers — Add padding of size `a` to the top and bottom of the input and padding of size `b` to the left and right.
- Vector `[t b l r]` of nonnegative integers — Add padding of size `t` to the top, `b` to the bottom, `l` to the left, and `r` to the right of the input.

Example: `'Padding', 1` adds one row of padding to the top and bottom, and one column of padding to the left and right of the input.

Example: `'Padding', 'same'` adds padding so that the output has the same size as the input (if the stride equals 1).

## Properties

### Max Pooling

#### **PoolSize** — Dimensions of pooling regions

vector of two positive integers

Dimensions of the pooling regions, specified as a vector of two positive integers `[h w]`, where `h` is the height and `w` is the width. When creating the layer, you can specify `PoolSize` as a scalar to use the same value for both dimensions.

If the stride dimensions `Stride` are less than the respective pooling dimensions, then the pooling regions overlap.

The padding dimensions `PaddingSize` must be less than the pooling region dimensions `PoolSize`.

Example: `[2 1]` specifies pooling regions of height 2 and width 1.

#### **Stride** — Step size for traversing input

`[1 1]` (default) | vector of two positive integers

Step size for traversing the input vertically and horizontally, specified as a vector of two positive integers `[a b]`, where `a` is the vertical step size and `b` is the horizontal step size. When creating the layer, you can specify `Stride` as a scalar to use the same value for both dimensions.

If the stride dimensions `Stride` are less than the respective pooling dimensions, then the pooling regions overlap.

The padding dimensions `PaddingSize` must be less than the pooling region dimensions `PoolSize`.

Example: `[2 3]` specifies a vertical step size of 2 and a horizontal step size of 3.

#### **PaddingSize** — Size of padding

`[0 0 0 0]` (default) | vector of four nonnegative integers

Size of padding to apply to input borders, specified as a vector `[t b l r]` of four nonnegative integers, where `t` is the padding applied to the top, `b` is the padding applied to the bottom, `l` is the padding applied to the left, and `r` is the padding applied to the right.

When you create a layer, use the `'Padding'` name-value pair argument to specify the padding size.



Example: `[1 1 2 2]` adds one row of padding to the top and bottom, and two columns of padding to the left and right of the input.

### PaddingMode — Method to determine padding size

`'manual'` (default) | `'same'`

Method to determine padding size, specified as `'manual'` or `'same'`.

The software automatically sets the value of `PaddingMode` based on the `'Padding'` value you specify when creating a layer.

- If you set the `'Padding'` option to a scalar or a vector of nonnegative integers, then the software automatically sets `PaddingMode` to `'manual'`.
- If you set the `'Padding'` option to `'same'`, then the software automatically sets `PaddingMode` to `'same'` and calculates the size of the padding at training time so that the output has the same size as the input when the stride equals 1. If the stride is larger than 1, then the output size is  $\text{ceil}(\text{inputSize}/\text{stride})$ , where `inputSize` is the height or width of the input and `stride` is the stride in the corresponding dimension. The software adds the same amount of padding to the top and bottom, and to the left and right, if possible. If the padding that must be added vertically has an odd value, then the software adds extra padding to the bottom. If the padding that must be added horizontally has an odd value, then the software adds extra padding to the right.

### Padding — Size of padding

`[0 0]` (default) | vector of two nonnegative integers

---

**Note** `Padding` property will be removed in a future release. Use `PaddingSize` instead. When creating a layer, use the `'Padding'` name-value pair argument to specify the padding size.

---

Size of padding to apply to input borders vertically and horizontally, specified as a vector `[a b]` of two nonnegative integers, where `a` is the padding applied to the top and bottom of the input data and `b` is the padding applied to the left and right.

Example: `[1 1]` adds one row of padding to the top and bottom, and one column of padding to the left and right of the input.

### HasUnpoolingOutputs — Flag for outputs to unpooling layer

`false` (default) | `true`

Flag for outputs to unpooling layer, specified as `true` or `false`.

If the `HasUnpoolingOutputs` value equals `false`, then the max pooling layer has a single output with the name `'out'`.

To use the output of a max pooling layer as the input to a max unpooling layer, set the `HasUnpoolingOutputs` value to `true`. In this case, the max pooling layer has two additional outputs that you can connect to a max unpooling layer:

- `'indices'` — Indices of the maximum value in each pooled region.
- `'size'` — Size of the input feature map.

To enable outputs to a max unpooling layer, the pooling regions of the max pooling layer must be nonoverlapping.

For more information on how to unpool the output of a max pooling layer, see `maxUnpooling2dLayer`.

## Layer

### Name — Layer name

' ' (default) | character vector | string scalar

Layer name, specified as a character vector or a string scalar. To include a layer in a layer graph, you must specify a nonempty unique layer name. If you train a series network with the layer and `Name` is set to ' ', then the software automatically assigns a name to the layer at training time.

Data Types: `char` | `string`

### NumInputs — Number of inputs

1 (default)

Number of inputs of the layer. This layer accepts a single input only.

Data Types: `double`

### InputNames — Input names

{ 'in' } (default)

Input names of the layer. This layer accepts a single input only.

Data Types: `cell`

### NumOutputs — Number of outputs

1 (default) | 3

Number of outputs of the layer.

If the `HasUnpoolingOutputs` value equals `false`, then the max pooling layer has a single output with the name 'out'.

To use the output of a max pooling layer as the input to a max unpooling layer, set the `HasUnpoolingOutputs` value to `true`. In this case, the max pooling layer has two additional outputs that you can connect to a max unpooling layer:

- 'indices' — Indices of the maximum value in each pooled region.
- 'size' — Size of the input feature map.

To enable outputs to a max unpooling layer, the pooling regions of the max pooling layer must be nonoverlapping.

For more information on how to unpool the output of a max pooling layer, see `maxUnpooling2dLayer`.

Data Types: `double`

### OutputNames — Output names

{ 'out' } (default) | { 'out', 'indices', 'size' }

Output names of the layer.

If the `HasUnpoolingOutputs` value equals `false`, then the max pooling layer has a single output with the name `'out'`.

To use the output of a max pooling layer as the input to a max unpooling layer, set the `HasUnpoolingOutputs` value to `true`. In this case, the max pooling layer has two additional outputs that you can connect to a max unpooling layer:

- `'indices'` — Indices of the maximum value in each pooled region.
- `'size'` — Size of the input feature map.

To enable outputs to a max unpooling layer, the pooling regions of the max pooling layer must be nonoverlapping.

For more information on how to unpool the output of a max pooling layer, see `maxUnpooling2dLayer`.

Data Types: `cell`

## Examples

### Create Max Pooling Layer with Nonoverlapping Pooling Regions

Create a max pooling layer with nonoverlapping pooling regions.

```
layer = maxPooling2dLayer(2, 'Stride', 2)
```

```
layer =
  MaxPooling2DLayer with properties:
      Name: ''
  HasUnpoolingOutputs: 0
      NumOutputs: 1
      OutputNames: {'out'}

  Hyperparameters
      PoolSize: [2 2]
      Stride: [2 2]
      PaddingMode: 'manual'
      PaddingSize: [0 0 0 0]
```

The height and the width of the rectangular regions (pool size) are both 2. The pooling regions do not overlap because the step size for traversing the images vertically and horizontally (stride) is also [2 2].

Include a max pooling layer with nonoverlapping regions in a `Layer` array.

```
layers = [ ...
  imageInputLayer([28 28 1])
  convolution2dLayer(5,20)
  reluLayer
  maxPooling2dLayer(2, 'Stride', 2)
  fullyConnectedLayer(10)
  softmaxLayer
  classificationLayer]
```

```

layers =
  7x1 Layer array with layers:

    1 '' Image Input          28x28x1 images with 'zerocenter' normalization
    2 '' Convolution          20 5x5 convolutions with stride [1 1] and padding [0 0 0 0]
    3 '' ReLU                  ReLU
    4 '' Max Pooling           2x2 max pooling with stride [2 2] and padding [0 0 0 0]
    5 '' Fully Connected       10 fully connected layer
    6 '' Softmax                softmax
    7 '' Classification Output crossentropyex

```

### Create Max Pooling Layer with Overlapping Pooling Regions

Create a max pooling layer with overlapping pooling regions.

```
layer = maxPooling2dLayer([3 2], 'Stride', 2)
```

```
layer =
  MaxPooling2DLayer with properties:
```

```

        Name: ''
  HasUnpoolingOutputs: 0
        NumOutputs: 1
        OutputNames: {'out'}
```

```

Hyperparameters
  PoolSize: [3 2]
  Stride: [2 2]
  PaddingMode: 'manual'
  PaddingSize: [0 0 0 0]
```

This layer creates pooling regions of size [3 2] and takes the maximum of the six elements in each region. The pooling regions overlap because there are stride dimensions `Stride` that are less than the respective pooling dimensions `PoolSize`.

Include a max pooling layer with overlapping pooling regions in a `Layer` array.

```

layers = [ ...
  imageInputLayer([28 28 1])
  convolution2dLayer(5,20)
  reluLayer
  maxPooling2dLayer([3 2], 'Stride', 2)
  fullyConnectedLayer(10)
  softmaxLayer
  classificationLayer]

```

```

layers =
  7x1 Layer array with layers:

    1 '' Image Input          28x28x1 images with 'zerocenter' normalization
    2 '' Convolution          20 5x5 convolutions with stride [1 1] and padding [0 0 0 0]
    3 '' ReLU                  ReLU
    4 '' Max Pooling           3x2 max pooling with stride [2 2] and padding [0 0 0 0]
    5 '' Fully Connected       10 fully connected layer

```

```

6  ''  Softmax          softmax
7  ''  Classification Output  crossentropyex

```

## More About

### Max Pooling Layer

A max pooling layer performs down-sampling by dividing the input into rectangular pooling regions, and computing the maximum of each region.

Pooling layers follow the convolutional layers for down-sampling, hence, reducing the number of connections to the following layers. They do not perform any learning themselves, but reduce the number of parameters to be learned in the following layers. They also help reduce overfitting.

A max pooling layer returns the maximum values of rectangular regions of its input. The size of the rectangular regions is determined by the `poolSize` argument of `maxPoolingLayer`. For example, if `poolSize` equals `[2, 3]`, then the layer returns the maximum value in regions of height 2 and width 3.

Pooling layers scan through the input horizontally and vertically in step sizes you can specify using the 'Stride' name-value pair argument. If the pool size is smaller than or equal to the stride, then the pooling regions do not overlap.

For nonoverlapping regions (*Pool Size* and *Stride* are equal), if the input to the pooling layer is  $n$ -by- $n$ , and the pooling region size is  $h$ -by- $h$ , then the pooling layer down-samples the regions by  $h$  [1]. That is, the output of a max or average pooling layer for one channel of a convolutional layer is  $n/h$ -by- $n/h$ . For overlapping regions, the output of a pooling layer is  $(Input\ Size - Pool\ Size + 2*Padding)/Stride + 1$ .

## References

- [1] Nagi, J., F. Ducatelle, G. A. Di Caro, D. Ciresan, U. Meier, A. Giusti, F. Nagi, J. Schmidhuber, L. M. Gambardella. "Max-Pooling Convolutional Neural Networks for Vision-based Hand Gesture Recognition". *IEEE International Conference on Signal and Image Processing Applications (ICSIPA2011)*, 2011.

## Extended Capabilities

### GPU Code Generation

Generate CUDA® code for NVIDIA® GPUs using GPU Coder™.

### See Also

`averagePooling2dLayer` | `convolution2dLayer` | `globalAveragePooling2dLayer` | `maxUnpooling2dLayer`

### Topics

"Create Simple Deep Learning Network for Classification"  
 "Train Convolutional Neural Network for Regression"  
 "Deep Learning in MATLAB"  
 "Specify Layers of Convolutional Neural Network"  
 "List of Deep Learning Layers"

**Introduced in R2016a**

# maxPooling3dLayer

3-D max pooling layer

## Description

A 3-D max pooling layer performs down-sampling by dividing three-dimensional input into cuboidal pooling regions, and computing the maximum of each region.

## Creation

### Syntax

```
layer = maxPooling3dLayer(poolSize)
layer = maxPooling3dLayer(poolSize,Name,Value)
```

### Description

`layer = maxPooling3dLayer(poolSize)` creates a 3-D max pooling layer and sets the `PoolSize` property.

`layer = maxPooling3dLayer(poolSize,Name,Value)` sets the optional `Stride` and `Name` properties using name-value pairs. To specify input padding, use the `'Padding'` name-value pair argument. For example, `maxPooling3dLayer(2,'Stride',3)` creates a 3-D max pooling layer with pool size `[2 2 2]` and stride `[3 3 3]`. You can specify multiple name-value pairs. Enclose each property name in single quotes.

### Input Arguments

#### Name-Value Pair Arguments

Use comma-separated name-value pair arguments to specify the size of the padding to add along the edges of the layer input and to set the `Stride` and `Name` properties. Enclose names in single quotes.

Example: `maxPooling3dLayer(2,'Stride',3)` creates a 3-D max pooling layer with pool size `[2 2 2]` and stride `[3 3 3]`.

#### Padding — Input edge padding

0 (default) | array of nonnegative integers | `'same'`

Input edge padding, specified as the comma-separated pair consisting of `'Padding'` and one of these values:

- `'same'` — Add padding of size calculated by the software at training or prediction time so that the output has the same size as the input when the stride equals 1. If the stride is larger than 1, then the output size is `ceil(inputSize/stride)`, where `inputSize` is the height, width, or depth of the input and `stride` is the stride in the corresponding dimension. The software adds the same amount of padding to the top and bottom, to the left and right, and to the front and back, if possible. If the padding in a given dimension has an odd value, then the software adds the extra padding to the input as postpadding. In other words, the software adds extra vertical padding to

the bottom, extra horizontal padding to the right, and extra depth padding to the back of the input.

- Nonnegative integer `p` — Add padding of size `p` to all the edges of the input.
- Three-element vector `[a b c]` of nonnegative integers — Add padding of size `a` to the top and bottom, padding of size `b` to the left and right, and padding of size `c` to the front and back of the input.
- 2-by-3 matrix `[t l f; b r k]` of nonnegative integers — Add padding of size `t` to the top, `b` to the bottom, `l` to the left, `r` to the right, `f` to the front, and `k` to the back of the input. In other words, the top row specifies the prepadding and the second row defines the postpadding in the three dimensions.

Example: 'Padding', 1 adds one row of padding to the top and bottom, one column of padding to the left and right, and one plane of padding to the front and back of the input.

Example: 'Padding', 'same' adds padding so that the output has the same size as the input (if the stride equals 1).

## Properties

### Max Pooling

#### **PoolSize — Dimensions of pooling regions**

vector of three positive integers

Dimensions of the pooling regions, specified as a vector of three positive integers `[h w d]`, where `h` is the height, `w` is the width, and `d` is the depth. When creating the layer, you can specify `PoolSize` as a scalar to use the same value for all three dimensions.

If the stride dimensions `Stride` are less than the respective pooling dimensions, then the pooling regions overlap.

The padding dimensions `PaddingSize` must be less than the pooling region dimensions `PoolSize`.

Example: `[2 1 1]` specifies pooling regions of height 2, width 1, and depth 1.

#### **Stride — Step size for traversing input**

`[1 1 1]` (default) | vector of three positive integers

Step size for traversing the input in three dimensions, specified as a vector `[a b c]` of three positive integers, where `a` is the vertical step size, `b` is the horizontal step size, and `c` is the step size along the depth direction. When creating the layer, you can specify `Stride` as a scalar to use the same value for step sizes in all three directions.

If the stride dimensions `Stride` are less than the respective pooling dimensions, then the pooling regions overlap.

The padding dimensions `PaddingSize` must be less than the pooling region dimensions `PoolSize`.

Example: `[2 3 1]` specifies a vertical step size of 2, a horizontal step size of 3, and a step size along the depth of 1.

#### **PaddingSize — Size of padding**

`[0 0 0; 0 0 0]` (default) | 2-by-3 matrix of nonnegative integers



Size of padding to apply to input borders, specified as 2-by-3 matrix  $[t \ l \ f; b \ r \ k]$  of nonnegative integers, where  $t$  and  $b$  are the padding applied to the top and bottom in the vertical direction,  $l$  and  $r$  are the padding applied to the left and right in the horizontal direction, and  $f$  and  $k$  are the padding applied to the front and back along the depth. In other words, the top row specifies the prepadding and the second row defines the postpadding in the three dimensions.

When you create a layer, use the 'Padding' name-value pair argument to specify the padding size.

Example: `[1 2 4; 1 2 4]` adds one row of padding to the top and bottom, two columns of padding to the left and right, and four planes of padding to the front and back of the input.

### PaddingMode — Method to determine padding size

'manual' (default) | 'same'

Method to determine padding size, specified as 'manual' or 'same'.

The software automatically sets the value of `PaddingMode` based on the 'Padding' value you specify when creating a layer.

- If you set the 'Padding' option to a scalar or a vector of nonnegative integers, then the software automatically sets `PaddingMode` to 'manual'.
- If you set the 'Padding' option to 'same', then the software automatically sets `PaddingMode` to 'same' and calculates the size of the padding at training time so that the output has the same size as the input when the stride equals 1. If the stride is larger than 1, then the output size is  $\text{ceil}(\text{inputSize}/\text{stride})$ , where `inputSize` is the height, width, or depth of the input and `stride` is the stride in the corresponding dimension. The software adds the same amount of padding to the top and bottom, to the left and right, and to the front and back, if possible. If the padding in a given dimension has an odd value, then the software adds the extra padding to the input as postpadding. In other words, the software adds extra vertical padding to the bottom, extra horizontal padding to the right, and extra depth padding to the back of the input.

## Layer

### Name — Layer name

' ' (default) | character vector | string scalar

Layer name, specified as a character vector or a string scalar. To include a layer in a layer graph, you must specify a nonempty unique layer name. If you train a series network with the layer and `Name` is set to ' ', then the software automatically assigns a name to the layer at training time.

Data Types: `char` | `string`

### NumInputs — Number of inputs

1 (default)

Number of inputs of the layer. This layer accepts a single input only.

Data Types: `double`

### InputNames — Input names

{'in'} (default)

Input names of the layer. This layer accepts a single input only.

Data Types: `cell`

**NumOutputs — Number of outputs**

1 (default)

Number of outputs of the layer. This layer has a single output only.

Data Types: double

**OutputNames — Output names**

{'out'} (default)

Output names of the layer. This layer has a single output only.

Data Types: cell

**Examples****Create Max Pooling 3-D Layer with Nonoverlapping Pooling Regions**

Create a max pooling 3-D layer with nonoverlapping pooling regions.

```
layer = maxPooling3dLayer(2,'Stride',2)
```

```
layer =  
MaxPooling3DLayer with properties:
```

```
    Name: ''  
    NumOutputs: 1  
    OutputNames: {'out'}  
  
    Hyperparameters  
        PoolSize: [2 2 2]  
        Stride: [2 2 2]  
        PaddingMode: 'manual'  
        PaddingSize: [2x3 double]
```

The height, width, and depth of the cuboidal regions (pool size) are 2. The step size for traversing the images (stride) is 2 in all dimensions. The pooling regions do not overlap because the stride is greater than or equal to the corresponding pool size in all dimensions.

Include a max pooling layer with nonoverlapping regions in a Layer array.

```
layers = [ ...  
    image3dInputLayer([28 28 28 3])  
    convolution3dLayer(5,20)  
    reluLayer  
    maxPooling3dLayer(2,'Stride',2)  
    fullyConnectedLayer(10)  
    softmaxLayer  
    classificationLayer]
```

```
layers =  
7x1 Layer array with layers:
```

```
 1 '' 3-D Image Input      28x28x28x3 images with 'zerocenter' normalization  
 2 '' Convolution          20 5x5x5 convolutions with stride [1 1 1] and padding [0  
 3 '' ReLU                  ReLU
```

```

4 '' 3-D Max Pooling      2x2x2 max pooling with stride [2 2 2] and padding [0 0
5 '' Fully Connected     10 fully connected layer
6 '' Softmax             softmax
7 '' Classification Output crossentropyex

```

## Create Max Pooling 3-D Layer with Overlapping Pooling Regions

Create a max pooling 3-D layer with overlapping pooling regions and padding for the top and bottom of the input.

```
layer = maxPooling3dLayer([3 2 2], 'Stride', 2, 'Padding', [1 0 0])
```

```

layer =
  MaxPooling3DLayer with properties:
    Name: ''
    NumOutputs: 1
    OutputNames: {'out'}

  Hyperparameters
    PoolSize: [3 2 2]
    Stride: [2 2 2]
    PaddingMode: 'manual'
    PaddingSize: [2x3 double]

```

This layer creates pooling regions of size 3-by-2-by-2 and takes the maximum of the twelve elements in each region. The stride is 2 in all dimensions. The pooling regions overlap because there are stride dimensions `Stride` that are less than the respective pooling dimensions `PoolSize`.

## More About

### 3-D Max Pooling Layer

A 3-D max pooling layer extends the functionality of a max pooling layer to a third dimension, depth. A max pooling layer performs down-sampling by dividing the input into rectangular or cuboidal pooling regions, and computing the maximum of each region. To learn more, see the definition of max pooling layer on page 1-579 on the `maxPooling2dLayer` reference page.

## See Also

[averagePooling3dLayer](#) | [convolution3dLayer](#) | [globalAveragePooling3dLayer](#) | [maxPooling2dLayer](#)

### Topics

“3-D Brain Tumor Segmentation Using Deep Learning”  
 “Deep Learning in MATLAB”  
 “Specify Layers of Convolutional Neural Network”  
 “List of Deep Learning Layers”

### Introduced in R2019a

## maxunpool

Unpool the output of a maximum pooling operation

### Syntax

```
dLY = maxunpool(dLX,indx,outputSize)
dLY = maxunpool(dLX,indx,outputSize,'DataFormat',FMT)
```

### Description

The maximum unpooling operation unpools the output of a maximum pooling operation by upsampling and padding with zeros.

---

**Note** This function applies the maximum unpooling operation to `dLarray` data. If you want to apply maximum unpooling within a `layerGraph` object or `Layer` array, use the following layer:

- `maxUnpooling2dLayer`
- 

`dLY = maxunpool(dLX,indx,outputSize)` upsamples the spatial dimensions of input data `dLX` to match the size `outputSize`. The data is padded with zeros between the locations of maximum values specified by `indx`. The input `dLX` is a formatted `dLarray` with dimension labels. The output `dLY` is a formatted `dLarray` with the same dimension labels as `dLX`.

`dLY = maxunpool(dLX,indx,outputSize,'DataFormat',FMT)` also specifies the dimension format `FMT` when `dLX` is not a formatted `dLarray`. The output `dLY` is an unformatted `dLarray` with the same dimension order as `dLX`.

## Examples

### Unpool Pooled Data

Create the input data as a single observation of random values with a height and width of six and a single channel.

```
height = 6;
width = 6;
channels = 1;
observations = 1;
```

```
X = rand(height,width,channels,observations);
dLX = dLarray(X,'SSCB')
```

Pool the data to maximum values over pooling regions of size 2 using a stride of 2.

```
[dLY,indx,dataSize] = maxpool(dLX,2,'Stride',2);
```

```
dLX =
    6(S) × 6(S) × 1(C) × 1(B) dLarray
```

```

0.8206    0.5945    0.6960    0.1508    0.9857    0.0168
0.9171    0.7565    0.9339    0.0515    0.0900    0.2920
0.9295    0.7223    0.4381    0.4417    0.2460    0.9403
0.6107    0.9710    0.4156    0.2089    0.1359    0.7609
0.3046    0.4560    0.4689    0.5395    0.3991    0.6321
0.8533    0.4369    0.2349    0.7844    0.7390    0.5615

```

```

dLY =
  3(S) × 3(S) × 1(C) × 1(B) dlarray

```

```

0.9171    0.9339    0.9857
0.9710    0.4417    0.9403
0.8533    0.7844    0.7390

```

```

indx =
  3(S) × 3(S) × 1(C) × 1(B) dlarray

```

```

  2    14    25
 10    21    33
  6    24    30

```

```

dataSize = 1×4
  6    6    1    1

```

Unpool the data using the indices and output size from the `maxpool` operation.

```

dLY = maxunpool(dLY,indx,dataSize)

```

```

dLY =
  6(S) × 6(S) × 1(C) × 1(B) dlarray

```

```

  0    0    0    0    0.9857    0
0.9171    0    0.9339    0    0    0
  0    0    0    0.4417    0    0.9403
  0    0.9710    0    0    0    0
  0    0    0    0    0    0
0.8533    0    0    0.7844    0.7390    0

```

## Input Arguments

### **dLX** — Input data

dlarray

Input data, specified as a `dlarray` with or without dimension labels. When `dLX` is not a formatted `dlarray`, you must specify the dimension label format using `'DataFormat', FMT`.

Unpooling acts on dimensions that you specify as spatial dimensions using the `'S'` dimension label. `dLX` must have at least one `'S'` dimension. You can specify up to three dimensions in `dLX` as `'S'` dimensions. Use the `dLY` output of the `maxpool` function as the `dLX` input to `maxunpool`.

Data Types: `single` | `double`

### **indx** — Indices of maximum values

dlarray

Indices of maximum values in each pooled region, specified as a `dIarray`.

Use the `indx` output of the `maxpool` function as the `indx` input to `maxpool`.

Data Types: `single` | `double`

### **outputSize — Size of output feature map**

numeric array

Size of the output feature map, specified as a numeric array.

Use the `inputSize` output of the `maxpool` function as the `outputSize` input to `maxunpool`.

Data Types: `single` | `double`

### **FMT — Dimension order of unformatted data**

char array | string

Dimension order of unformatted input data, specified as the comma-separated pair consisting of `'DataFormat'` and a character array or string `FMT` that provides a label for each dimension of the data. Each character in `FMT` must be one of the following:

- `'S'` — Spatial
- `'C'` — Channel
- `'B'` — Batch (for example, samples and observations)
- `'T'` — Time (for example, sequences)
- `'U'` — Unspecified

You can specify multiple dimensions labeled `'S'` or `'U'`. You can use the labels `'C'`, `'B'`, and `'T'` at most once.

You must specify `'DataFormat'`, `FMT` when the input data `dIX` is not a formatted `dIarray`.

Example: `'DataFormat'`, `'SSCB'`

Data Types: `char` | `string`

## **Output Arguments**

### **dIY — Unpooled data**

`dIarray`

Unpooled data, returned as a `dIarray`. The output `dIY` has the same underlying data type as the input `dIX`.

If the input data `dIX` is a formatted `dIarray`, `dIY` has the same dimension labels as `dIX`. If the input data is not a formatted `dIarray`, `dIY` is an unformatted `dIarray` with the same dimension order as the input data.

## **Extended Capabilities**

### **GPU Arrays**

Accelerate code by running on a graphics processing unit (GPU) using Parallel Computing Toolbox™.

Usage notes and limitations:

- When the input argument `dlX` is a `dlarray` with underlying data of type `gpuArray`, this function runs on the GPU.

For more information, see “Run MATLAB Functions on a GPU” (Parallel Computing Toolbox).

## See Also

`dlarray` | `dlfeval` | `dlgradient` | `maxpool`

## Topics

“Define Custom Training Loops, Loss Functions, and Networks”

“Train Network Using Model Function”

**Introduced in R2019b**

# maxUnpooling2dLayer

Max unpooling layer

## Description

A max unpooling layer unpools the output of a max pooling layer.

## Creation

### Syntax

```
layer = maxUnpooling2dLayer  
layer = maxUnpooling2dLayer('Name', name)
```

### Description

`layer = maxUnpooling2dLayer` creates a max unpooling layer.

`layer = maxUnpooling2dLayer('Name', name)` sets the `Name` property. To create a network containing a max unpooling layer you must specify a layer name.

## Properties

### Name — Layer name

' ' (default) | character vector | string scalar

Layer name, specified as a character vector or a string scalar. To include a layer in a layer graph, you must specify a nonempty unique layer name. If you train a series network with the layer and `Name` is set to ' ', then the software automatically assigns a name to the layer at training time.

Data Types: `char` | `string`

### NumInputs — Number of inputs

3 (default)

Number of inputs of the layer.

There are three inputs to this layer:

- `'in'` — Input feature map to unpool.
- `'indices'` — Indices of the maximum value in each pooled region. This is output by the max pooling layer.
- `'size'` — Output size of unpooled feature map. This is output by the max pooling layer.

Use the input names when connecting or disconnecting the max unpooling layer to other layers using `connectLayers` or `disconnectLayers`.

Data Types: `double`



**InputNames — Input names**

{'in', 'indices', 'size'} (default)

Input names of the layer.

There are three inputs to this layer:

- 'in' — Input feature map to unpool.
- 'indices' — Indices of the maximum value in each pooled region. This is output by the max pooling layer.
- 'size' — Output size of unpooled feature map. This is output by the max pooling layer.

Use the input names when connecting or disconnecting the max unpooling layer to other layers using `connectLayers` or `disconnectLayers`.

Data Types: cell

**NumOutputs — Number of outputs**

1 (default)

Number of outputs of the layer. This layer has a single output only.

Data Types: double

**OutputNames — Output names**

{'out'} (default)

Output names of the layer. This layer has a single output only.

Data Types: cell

**Examples****Create Max Unpooling Layer**

Create a max unpooling layer that unpools the output of a max pooling layer.

```
layer = maxUnpooling2dLayer
```

```
layer =
```

```
  MaxUnpooling2DLayer with properties:
```

```
    Name: ''
```

```
    NumInputs: 3
```

```
    InputNames: {'in' 'indices' 'size'}
```

**Unpool Max Pooling Layer**

Create a max pooling layer, and set the `'HasUnpoolingOutputs'` property as `true`. This property gives the max pooling layer two additional outputs, `'indices'` and `'size'`, which enables unpooling the layer. Also create a max unpooling layer.

```
layers = [  
    maxPooling2dLayer(2, 'Stride', 2, 'Name', 'mpool', 'HasUnpoolingOutputs', true)  
    maxUnpooling2dLayer('Name', 'unpool');  
]  
  
layers =  
    2x1 Layer array with layers:  
  
    1 'mpool'    Max Pooling    2x2 max pooling with stride [2 2] and padding [0 0 0 0]  
    2 'unpool'  Max Unpooling  Max Unpooling
```

Sequentially connect layers by adding them to a `layerGraph`. This step connects the 'out' output of the max pooling layer to the 'in' input of the max unpooling layer.

```
lgraph = layerGraph(layers)  
  
lgraph =  
    LayerGraph with properties:  
  
        Layers: [2x1 nnet.cnn.layer.Layer]  
        Connections: [1x2 table]  
        InputNames: {1x0 cell}  
        OutputNames: {1x0 cell}
```

Unpool the output of the max pooling layer, by connecting the max pooling layer outputs to the max unpooling layer inputs.

```
lgraph = connectLayers(lgraph, 'mpool/indices', 'unpool/indices');  
lgraph = connectLayers(lgraph, 'mpool/size', 'unpool/size');
```

## Extended Capabilities

### GPU Code Generation

Generate CUDA® code for NVIDIA® GPUs using GPU Coder™.

### See Also

[connectLayers](#) | [disconnectLayers](#) | [layerGraph](#) | [maxPooling2dLayer](#) | [trainNetwork](#)

### Topics

“Deep Learning in MATLAB”  
“Specify Layers of Convolutional Neural Network”  
“Train Residual Network for Image Classification”  
“List of Deep Learning Layers”

### Introduced in R2017b

# mobilenetv2

MobileNet-v2 convolutional neural network

## Syntax

```
net = mobilenetv2
net = mobilenetv2('Weights','imagenet')

lgraph = mobilenetv2('Weights','none')
```

## Description

MobileNet-v2 is a convolutional neural network that is 53 layers deep. You can load a pretrained version of the network trained on more than a million images from the ImageNet database [1]. The pretrained network can classify images into 1000 object categories, such as keyboard, mouse, pencil, and many animals. As a result, the network has learned rich feature representations for a wide range of images. The network has an image input size of 224-by-224. For more pretrained networks in MATLAB, see “Pretrained Deep Neural Networks”.

You can use `classify` to classify new images using the MobileNet-v2 model. Follow the steps of “Classify Image Using GoogLeNet” and replace GoogLeNet with MobileNet-v2.

To retrain the network on a new classification task, follow the steps of “Train Deep Learning Network to Classify New Images” and load MobileNet-v2 instead of GoogLeNet.

`net = mobilenetv2` returns a MobileNet-v2 network trained on the ImageNet data set.

This function requires the Deep Learning Toolbox Model *for MobileNet-v2 Network* support package. If this support package is not installed, then the function provides a download link.

`net = mobilenetv2('Weights','imagenet')` returns a MobileNet-v2 network trained on the ImageNet data set. This syntax is equivalent to `net = mobilenetv2('Weights','imagenet')`.

`lgraph = mobilenetv2('Weights','none')` returns the untrained MobileNet-v2 network architecture. The untrained model does not require the support package.

## Examples

### Download MobileNet-v2 Support Package

Download and install the Deep Learning Toolbox Model *for MobileNet-v2 Network* support package.

Type `mobilenetv2` at the command line.

```
mobilenetv2
```

If the Deep Learning Toolbox Model *for MobileNet-v2 Network* support package is not installed, then the function provides a link to the required support package in the Add-On Explorer. To install the support package, click the link, and then click **Install**. Check that the installation is successful by

typing `mobilenetv2` at the command line. If the required support package is installed, then the function returns a `DAGNetwork` object.

```
mobilenetv2
ans =
    DAGNetwork with properties:
        Layers: [155x1 nnet.cnn.layer.Layer]
        Connections: [164x2 table]
```

## Output Arguments

### **net** — Pretrained MobileNet-v2 convolutional neural network

`DAGNetwork` object

Pretrained MobileNet-v2 convolutional neural network, returned as a `DAGNetwork` object.

### **lgraph** — Untrained MobileNet-v2 convolutional neural network architecture

`LayerGraph` object

Untrained MobileNet-v2 convolutional neural network architecture, returned as a `LayerGraph` object.

## References

[1] *ImageNet*. <http://www.image-net.org>

[2] Sandler, M., Howard, A., Zhu, M., Zhmoginov, A. and Chen, L.C. "MobileNetV2: Inverted Residuals and Linear Bottlenecks." In *2018 IEEE/CVF Conference on Computer Vision and Pattern Recognition* (pp. 4510-4520). IEEE.

## Extended Capabilities

### **C/C++ Code Generation**

Generate C and C++ code using MATLAB® Coder™.

For code generation, you can load the network by using the syntax `net = mobilenetv2` or by passing the `mobilenetv2` function to `coder.loadDeepLearningNetwork`. For example: `net = coder.loadDeepLearningNetwork('mobilenetv2')`

For more information, see "Load Pretrained Networks for Code Generation" (MATLAB Coder).

The syntax `mobilenetv2('Weights', 'none')` is not supported for code generation.

### **GPU Code Generation**

Generate CUDA® code for NVIDIA® GPUs using GPU Coder™.

Usage notes and limitations:

- For code generation, you can load the network by using the syntax `net = mobilenetv2` or by passing the `mobilenetv2` function to `coder.loadDeepLearningNetwork`. For example: `net = coder.loadDeepLearningNetwork('mobilenetv2')`

For more information, see “Load Pretrained Networks for Code Generation” (GPU Coder).

- The syntax `mobilenetv2('Weights', 'none')` is not supported for GPU code generation.

## See Also

[DAGNetwork](#) | [alexnet](#) | [densenet201](#) | [googlenet](#) | [inceptionresnetv2](#) | [layerGraph](#) | [plot](#) | [resnet101](#) | [resnet50](#) | [squeezenet](#) | [trainNetwork](#) | [vgg16](#) | [vgg19](#)

## Topics

“Deep Learning in MATLAB”

“Pretrained Deep Neural Networks”

“Classify Image Using GoogLeNet”

“Train Deep Learning Network to Classify New Images”

“Train Residual Network for Image Classification”

## Introduced in R2019a

## mse

Half mean squared error

### Syntax

```
dLY = mse(dlX, targets)
dLY = mse(dlX, targets, 'DataFormat', FMT)
```

### Description

The half mean squared error operation computes the half mean squared error loss between network predictions and target values for regression tasks.

The loss is calculated using the following formula

$$\text{loss} = \frac{1}{2N} \sum_{i=1}^M (X_i - T_i)^2$$

where  $X_i$  is the network response,  $T_i$  is the target value,  $M$  is the total number of responses in  $X$  (across all observations), and  $N$  is the total number of observations in  $X$ .

---

**Note** This function computes the half mean squared error loss between predictions and targets stored as `dLarray` data. If you want to calculate the half mean squared error loss within a `layerGraph` object or `Layer` array for use with `trainNetwork`, use the following layer:

- `regressionLayer`
- 

`dLY = mse(dlX, targets)` computes the half mean squared error loss between the predictions `dlX` and the target values `targets` for regression problems. The input `dlX` is a formatted `dLarray` with dimension labels. The output `dLY` is an unformatted scalar `dLarray` with no dimension labels.

`dLY = mse(dlX, targets, 'DataFormat', FMT)` also specifies the dimension format `FMT` when `dlX` is not a formatted `dLarray`.

### Examples

#### Find Half Mean Squared Error Between Predicted and Target Values

The half mean squared error evaluates how well the network predictions correspond to the target values.

Create the input predictions as a single observation of random values with a height and width of six and a single channel.

```
height = 6;
width = 6;
```

```

channels = 1;
observations = 1;

X = rand(height,width,channels,observations);
d1X = dlarray(X, 'SSCB')

```

Create the target values as a numeric array with the same dimension order as the input data `d1X`.

```

targets = ones(height,width,channels,observations);

```

Compute the half mean squared error between the predictions and the targets.

```

d1Y = mse(d1X,targets)

```

```

d1Y =

```

```

    1x1 dlarray

```

```

    5.2061

```

## Input Arguments

### **d1X — Predictions**

`dlarray` | numeric array

Predictions, specified as a `dlarray` with or without dimension labels or a numeric array. When `d1X` is not a formatted `dlarray`, you must specify the dimension label format using `'DataFormat'`, `FMT`. If `d1X` is a numeric array, `targets` must be a `dlarray`.

Data Types: `single` | `double`

### **targets — Target values**

`dlarray` | numeric array

Target values, specified as a formatted or unformatted `dlarray` or a numeric array.

If `targets` is a formatted `dlarray`, its dimension format must be the same as the format of `X`, or the same as `'DataFormat'` if `X` is unformatted.

If `targets` is an unformatted `dlarray` or a numeric array, the size of `targets` must exactly match the size of `X`. The format of `X` or the value of `'DataFormat'` is implicitly applied to `targets`.

Data Types: `single` | `double`

### **FMT — Dimension order of unformatted data**

`char array` | `string`

Dimension order of unformatted input data, specified as the comma-separated pair consisting of `'DataFormat'` and a character array or string `FMT` that provides a label for each dimension of the data. Each character in `FMT` must be one of the following:

- `'S'` — Spatial
- `'C'` — Channel
- `'B'` — Batch (for example, samples and observations)
- `'T'` — Time (for example, sequences)

- 'U' — Unspecified

You can specify multiple dimensions labeled 'S' or 'U'. You can use the labels 'C', 'B', and 'T' at most once.

You must specify 'DataFormat', FMT when the input data dLX is not a formatted dLarray.

Example: 'DataFormat', 'SSCB'

Data Types: char | string

## Output Arguments

### dLY — Half mean squared error loss

dLarray scalar

Half mean squared error loss, returned as a dLarray scalar without dimension labels. The output dLY has the same underlying data type as the input dLX.

## More About

### Half Mean Squared Error Loss

The mse function computes the half-mean-squared-error loss for regression problems. For more information, see the definition of “Regression Output Layer” on page 1-652 on the RegressionOutputLayer reference page.

## Extended Capabilities

### GPU Arrays

Accelerate code by running on a graphics processing unit (GPU) using Parallel Computing Toolbox™.

Usage notes and limitations:

- When at least one of the following input arguments is a gpuArray or a dLarray with underlying data of type gpuArray, this function runs on the GPU:
  - dLX
  - targets

For more information, see “Run MATLAB Functions on a GPU” (Parallel Computing Toolbox).

## See Also

crossentropy | dLarray | dlfeval | dlgradient | sigmoid

### Topics

“Define Custom Training Loops, Loss Functions, and Networks”

“Train Network with Multiple Outputs”

### Introduced in R2019b



# nasnetlarge

Pretrained NASNet-Large convolutional neural network

## Syntax

```
net = nasnetlarge
```

## Description

NASNet-Large is a convolutional neural network that is trained on more than a million images from the ImageNet database [1]. The network can classify images into 1000 object categories, such as keyboard, mouse, pencil, and many animals. As a result, the network has learned rich feature representations for a wide range of images. The network has an image input size of 331-by-331. For more pretrained networks in MATLAB, see “Pretrained Deep Neural Networks”.

You can use `classify` to classify new images using the NASNet-Large model. Follow the steps of “Classify Image Using GoogLeNet” and replace GoogLeNet with NASNet-Large.

To retrain the network on a new classification task, follow the steps of “Train Deep Learning Network to Classify New Images” and load NASNet-Large instead of GoogLeNet.

`net = nasnetlarge` returns a pretrained NASNet-Large convolutional neural network.

This function requires the *Deep Learning Toolbox Model for NASNet-Large Network* support package. If this support package is not installed, then the function provides a download link.

## Examples

### Download NASNet-Large Support Package

Download and install the *Deep Learning Toolbox Model for NASNet-Large Network* support package.

Type `nasnetlarge` at the command line.

```
nasnetlarge
```

If the *Deep Learning Toolbox Model for NASNet-Large Network* support package is not installed, then the function provides a link to the required support package in the Add-On Explorer. To install the support package, click the link, and then click **Install**. Check that the installation is successful by typing `nasnetlarge` at the command line. If the required support package is installed, then the function returns a DAGNetwork object.

```
nasnetlarge
```

```
ans =
```

```
    DAGNetwork with properties:
```

```
Layers: [1244x1 nnet.cnn.layer.Layer]  
Connections: [1463x2 table]
```

## Transfer Learning with NASNet-Large

You can use transfer learning to retrain the network to classify a new set of images.

Open the example “Train Deep Learning Network to Classify New Images”. The original example uses the GoogLeNet pretrained network. To perform transfer learning using a different network, load your desired pretrained network and follow the steps in the example.

Load the NASNet-Large network instead of GoogLeNet.

```
net = nasnetlarge
```

Follow the remaining steps in the example to retrain your network. You must replace the last learnable layer and the classification layer in your network with new layers for training. The example shows you how to find which layers to replace.

## Output Arguments

### **net** — Pretrained NASNet-Large convolutional neural network

DAGNetwork object

Pretrained NASNet-Large convolutional neural network, returned as a DAGNetwork object.

## References

[1] *ImageNet*. <http://www.image-net.org>

[2] Zoph, Barret, Vijay Vasudevan, Jonathon Shlens, and Quoc V. Le. "Learning Transferable Architectures for Scalable Image Recognition ." *arXiv preprint arXiv:1707.07012* 2, no. 6 (2017).

## Extended Capabilities

### **C/C++ Code Generation**

Generate C and C++ code using MATLAB® Coder™.

For code generation, you can load the network by using the syntax `net = nasnetlarge` or by passing the `nasnetlarge` function to `coder.loadDeepLearningNetwork`. For example: `net = coder.loadDeepLearningNetwork('nasnetlarge')`

For more information, see “Load Pretrained Networks for Code Generation” (MATLAB Coder).

### **GPU Code Generation**

Generate CUDA® code for NVIDIA® GPUs using GPU Coder™.

Usage notes and limitations:

For code generation, you can load the network by using the syntax `net = nasnetlarge` or by passing the `nasnetlarge` function to `coder.loadDeepLearningNetwork`. For example: `net = coder.loadDeepLearningNetwork('nasnetlarge')`

For more information, see “Load Pretrained Networks for Code Generation” (GPU Coder).

## See Also

[DAGNetwork](#) | [densenet201](#) | [googlenet](#) | [inceptionresnetv2](#) | [layerGraph](#) | [nasnetmobile](#) | [plot](#) | [resnet101](#) | [resnet50](#) | [shufflenet](#) | [squeezeNet](#) | [trainNetwork](#) | [vgg16](#) | [vgg19](#)

## Topics

“Deep Learning in MATLAB”

“Pretrained Deep Neural Networks”

“Classify Image Using GoogLeNet”

“Train Deep Learning Network to Classify New Images”

“Train Residual Network for Image Classification”

## Introduced in R2019a

## nasnetmobile

Pretrained NASNet-Mobile convolutional neural network

### Syntax

```
net = nasnetmobile
```

### Description

NASNet-Mobile is a convolutional neural network that is trained on more than a million images from the ImageNet database [1]. The network can classify images into 1000 object categories, such as keyboard, mouse, pencil, and many animals. As a result, the network has learned rich feature representations for a wide range of images. The network has an image input size of 224-by-224. For more pretrained networks in MATLAB, see “Pretrained Deep Neural Networks”.

You can use `classify` to classify new images using the NASNet-Mobile model. Follow the steps of “Classify Image Using GoogLeNet” and replace GoogLeNet with NASNet-Mobile.

To retrain the network on a new classification task, follow the steps of “Train Deep Learning Network to Classify New Images” and load NASNet-Mobile instead of GoogLeNet.

`net = nasnetmobile` returns a pretrained NASNet-Mobile convolutional neural network.

This function requires the *Deep Learning Toolbox Model for NASNet-Mobile Network* support package. If this support package is not installed, then the function provides a download link.

### Examples

#### Download NASNet-Mobile Support Package

Download and install the *Deep Learning Toolbox Model for NASNet-Mobile Network* support package.

Type `nasnetmobile` at the command line.

```
nasnetmobile
```

If the *Deep Learning Toolbox Model for NASNet-Mobile Network* support package is not installed, then the function provides a link to the required support package in the Add-On Explorer. To install the support package, click the link, and then click **Install**. Check that the installation is successful by typing `nasnetmobile` at the command line. If the required support package is installed, then the function returns a `DAGNetwork` object.

```
nasnetmobile
```

```
ans =
```

```
    DAGNetwork with properties:
```

```
Layers: [914x1 nnet.cnn.layer.Layer]  
Connections: [1073x2 table]
```

## Transfer Learning with NASNet-Mobile

You can use transfer learning to retrain the network to classify a new set of images.

Open the example “Train Deep Learning Network to Classify New Images”. The original example uses the GoogLeNet pretrained network. To perform transfer learning using a different network, load your desired pretrained network and follow the steps in the example.

Load the NASNet-Mobile network instead of GoogLeNet.

```
net = nasnetmobile
```

Follow the remaining steps in the example to retrain your network. You must replace the last learnable layer and the classification layer in your network with new layers for training. The example shows you how to find which layers to replace.

## Output Arguments

### **net** — Pretrained NASNet-Mobile convolutional neural network

DAGNetwork object

Pretrained NASNet-Mobile convolutional neural network, returned as a DAGNetwork object.

## References

[1] *ImageNet*. <http://www.image-net.org>

[2] Zoph, Barret, Vijay Vasudevan, Jonathon Shlens, and Quoc V. Le. "Learning Transferable Architectures for Scalable Image Recognition ." *arXiv preprint arXiv:1707.07012* 2, no. 6 (2017).

## Extended Capabilities

### **C/C++ Code Generation**

Generate C and C++ code using MATLAB® Coder™.

For code generation, you can load the network by using the syntax `net = nasnetmobile` or by passing the `nasnetmobile` function to `coder.loadDeepLearningNetwork`. For example: `net = coder.loadDeepLearningNetwork('nasnetmobile')`

For more information, see “Load Pretrained Networks for Code Generation” (MATLAB Coder).

### **GPU Code Generation**

Generate CUDA® code for NVIDIA® GPUs using GPU Coder™.

Usage notes and limitations:

For code generation, you can load the network by using the syntax `net = nasnetmobile` or by passing the `nasnetmobile` function to `coder.loadDeepLearningNetwork`. For example: `net = coder.loadDeepLearningNetwork('nasnetmobile')`

For more information, see “Load Pretrained Networks for Code Generation” (GPU Coder).

## See Also

[DAGNetwork](#) | [densenet201](#) | [googlenet](#) | [inceptionresnetv2](#) | [layerGraph](#) | [nasnetlarge](#) | [plot](#) | [resnet101](#) | [resnet50](#) | [shufflenet](#) | [squeezeNet](#) | [trainNetwork](#) | [vgg16](#) | [vgg19](#)

## Topics

“Deep Learning in MATLAB”

“Pretrained Deep Neural Networks”

“Classify Image Using GoogLeNet”

“Train Deep Learning Network to Classify New Images”

“Train Residual Network for Image Classification”

**Introduced in R2019a**

# occlusionSensitivity

Determine how input data affects output activations by occluding input

## Syntax

```
scoreMap = occlusionSensitivity(net,X,label)
activationMap = occlusionSensitivity(net,X,layer,channel)
___ = occlusionSensitivity(___ ,Name,Value)
```

## Description

`scoreMap = occlusionSensitivity(net,X,label)` computes a map of the change in classification score for the classes specified by `label` when parts of the input data `X` are occluded with a mask. The change in classification score is relative to the original data without occlusion. The occluding mask is moved across the input data, giving a change in classification score for each mask location. Use an occlusion map to identify the parts of your input data that most impact the classification score. Areas in the map with higher positive values correspond to regions of input data that contribute positively to the specified classification label. The network must contain a `softmaxLayer` followed by a `classificationLayer`.

`activationMap = occlusionSensitivity(net,X,layer,channel)` computes a map of the change in total activation for the specified layer and channel when parts of the input data `X` are occluded with a mask. The change in activation score is relative to the original data without occlusion. Areas in the map with higher positive values correspond to regions of input data that contribute positively to the specified channel activation, obtained by summing over all spatial dimensions for that channel.

`___ = occlusionSensitivity(___ ,Name,Value)` specifies options using one or more name-value pair arguments in addition to the input arguments in previous syntaxes. For example, `'Stride',50` sets the stride of the occluding mask to 50 pixels.

## Examples

### Visualize Which Parts of an Image Influence Classification Score

Import the pretrained network GoogLeNet.

```
net = googlenet;
```

Import the image and resize to match the input size for the network.

```
X = imread("sherlock.jpg");
```

```
inputSize = net.Layers(1).InputSize(1:2);
X = imresize(X,inputSize);
```

Display the image.

```
imshow(X)
```



Classify the image to get the class label.

```
label = classify(net,X)
label = categorical categorical
       golden retriever
```

Use `occlusionSensitivity` to determine which parts of the image positively influence the classification result.

```
scoreMap = occlusionSensitivity(net,X,label);
```

Plot the result over the original image with transparency to see which areas of the image affect the classification score.

```
figure
imshow(X)
hold on
imagesc(scoreMap, 'AlphaData', 0.5);
colormap jet
```



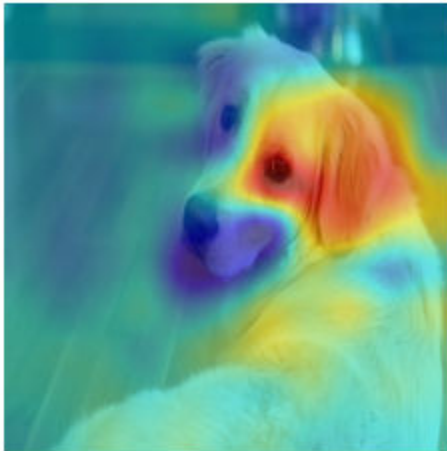

The red parts of the map show the areas which have a positive contribution to the specified label. The dog's left eye and ear strongly influence the network's prediction of golden retriever.

You can get similar results using the gradient class activation mapping (Grad-CAM) technique. Grad-CAM uses the gradient of the classification score with respect to the last convolutional layer in a network in order to understand which parts of the image are most important for classification. For an example, see “Grad-CAM Reveals the Why Behind Deep Learning Decisions”.

## Input Arguments

### **net** — Trained network

SeriesNetwork object | DAGNetwork object

Trained network, specified as a SeriesNetwork object or a DAGNetwork object. You can get a trained network by importing a pretrained network or by training your own network using the `trainNetwork` function. For more information about pretrained networks, see “Pretrained Deep Neural Networks”.

`net` must contain a single input layer. The input layer must be an `imageInputLayer`.

### **X** — Observation to occlude

numeric array

Observation to occlude, specified as a numeric array. You can calculate the occlusion map of one observation at a time. For example, specify a single image to understand which parts of that image affect classification results.

Data Types: `single` | `double` | `int8` | `int16` | `int32` | `int64` | `uint8` | `uint16` | `uint32` | `uint64`

### **label** — Class label used to calculate change in classification score

categorical array | character array | string array

Class label used to calculate change in classification score, specified as a categorical, a character array, or a string array.

If `label` is specified as a vector, the change in classification score for each class label is calculated independently. In that case, `scoreMap(:, :, i)` corresponds to the occlusion map for the *i*th element in `label`.

Data Types: `char` | `string` | `categorical`

### **layer** — Layer used to calculate change in activation

character vector | string scalar

Layer used to calculate change in activation, specified as a character vector or a string scalar. Specify `layer` as the name of the layer in `net` for which you want to compute the change in activations.

Data Types: `char` | `string`

### **channel** — Channel used to calculate change in activation

numeric index | vector of numeric indices

Channel used to calculate change in activation, specified as scalar or vector of channel indices. The possible choices for `channel` depend on the selected layer. For example, for convolutional layers, the `NumFilters` property specifies the number of output channels. You can use `analyzeNetwork` to inspect the network and find out the number of output channels for each layer.

If `channel` is specified as a vector, the change in total activation for each specified channel is calculated independently. In that case, `activationMap(:, :, i)` corresponds to the occlusion map for the *i*th element in `channel`.

The function computes the change in total activation due to occlusion. The total activation is computed by summing over all spatial dimensions of the activation of that channel. The occlusion map corresponds to the difference between the total activation of the original data with no occlusion and the total activation for the occluded data. Areas in the map with higher positive values correspond to regions of input data that contribute positively to the specified channel activation.

Data Types: `single` | `double` | `int8` | `int16` | `int32` | `int64` | `uint8` | `uint16` | `uint32` | `uint64`

### **Name-Value Pair Arguments**

Specify optional comma-separated pairs of `Name`, `Value` arguments. `Name` is the argument name and `Value` is the corresponding value. `Name` must appear inside quotes. You can specify several name and value pair arguments in any order as `Name1, Value1, ..., NameN, ValueN`.

Example: `'MaskSize', 75, 'OutputUpsampling', 'nearest'` uses an occluding mask with size 75 pixels along each side, and uses nearest-neighbor interpolation to upsample the output to the same size as the input data

### **MaskSize** — Size of occluding mask

'auto' (default) | vector | scalar

Size of occluding mask, specified as the comma-separated pair consisting of `'MaskSize'` and one of the following.

- `'auto'` — Use a mask size of 20% of the input size, rounded to the nearest integer.
- A vector of the form `[h w]`— Use a rectangular mask with height *h* and width *w*.

- A scalar — Use a square mask with height and width equal to the specified value.

Example: 'MaskSize', [50 60]

### **Stride — Step size for traversing mask across input data**

'auto' (default) | vector | scalar

Step size for traversing the mask across the input data, specified as the comma-separated pair consisting of 'Stride' and one of the following.

- 'auto' — Use a stride of 10% of the input size, rounded to the nearest integer.
- A vector of the form [a b]— Use a vertical stride of a and a horizontal stride of b.
- A scalar — Use a stride of the specified value in both the vertical and horizontal directions.

Example: 'Stride', 30

### **MaskValue — Replacement value of occluded region**

'auto' (default) | scalar | vector

Replacement value of occluded region, specified as the comma-separated pair consisting of 'MaskValue' and one of the following.

- 'auto' — Replace occluded pixels with the channel-wise mean of the input data.
- A scalar — Replace occluded pixels with the specified value.
- A vector — Replace occluded pixels with the value specified for each channel. The vector must contain the same number of elements as the number of output channels of the layer.

Example: 'MaskValue', 0.5

### **OutputUpsampling — Output upsampling method**

'bicubic' (default) | 'nearest' | 'none'

Output upsampling method, specified as the comma-separated pair consisting of 'OutputUpsampling' and one of the following.

- 'bicubic' — Use bicubic interpolation to produce a smooth map the same size as the input data.
- 'nearest' — Use nearest-neighbor interpolation expand the map to the same size as the input data. The map indicates the resolution of the occlusion computation with respect to the size of the input data.
- 'none' — Use no upsampling. The map can be smaller than the input data.

If 'OutputUpsampling' is 'bicubic' or 'nearest', the computed map is upsampled to the size of the input data using the `imresize` function.

Example: 'OutputUpsampling', 'nearest'

### **MaskClipping — Edge handling of the occluding mask**

'on' (default) | 'off'

Edge handling of the occluding mask, specified as the comma-separated pair consisting of 'MaskClipping' and one of the following.

- 'on' — Place the center of the first mask at the top-left corner of the input data. Masks at the edges of the data are not full size.

- 'off' — Place the top-left corner of the first mask at the top-left corner of the input data. Masks are always full size. If the values of the `MaskSize` and `Stride` options mean that some masks extend past the boundaries of the data, those masks are excluded.

For non-image input data, you can ensure you always occlude the same amount of input data using the option `'MaskClipping', 'off'`. For example, for word embeddings data, you can ensure the same number of words are occluded at each point.

Example: `'MaskClipping', 'off'`

### **MiniBatchSize — Size of mini-batch**

128 (default) | positive integer

Size of the mini-batch to use for each training iteration, specified as the comma-separated pair consisting of `'MiniBatchSize'` and a positive integer. A mini-batch is a subset of the training set that is used to evaluate the gradient of the loss function and update the weights. See “Stochastic Gradient Descent” on page 1-800.

Example: `'MiniBatchSize', 256`

### **ExecutionEnvironment — Hardware resource for training network**

'auto' (default) | 'cpu' | 'gpu'

Hardware resource for training network, specified as the comma-separated pair consisting of `'ExecutionEnvironment'` and one of the following.

- 'auto' — Use a GPU if one is available. Otherwise, use the CPU.
- 'cpu' — Use the CPU.
- 'gpu' — Use the GPU.

The GPU option requires Parallel Computing Toolbox. To use a GPU for deep learning, you must also have a CUDA enabled NVIDIA GPU with compute capability 3.0 or higher. If you choose the `'ExecutionEnvironment', 'gpu'` option and Parallel Computing Toolbox or a suitable GPU is not available, then the software returns an error.

Example: `'ExecutionEnvironment', 'gpu'`

## **Output Arguments**

### **scoreMap — Map of change of classification score**

numeric matrix | numeric array

Map of change of classification score, returned as a numeric matrix or a numeric array. The change in classification score is calculated relative to the original input data without occlusion. Areas in the map with higher positive values correspond to regions of input data that contribute positively to the specified classification label.

If `label` is specified as a vector, the change in classification score for each class label is calculated independently. In that case, `scoreMap(:, :, i)` corresponds to the occlusion map for the *i*th element in `label`.

### **activationMap — Map of change of total activation**

numeric matrix | numeric array

Map of change of total activation, returned as a numeric matrix or a numeric array.

The function computes the change in total activation due to occlusion. The total activation is computed by summing over all spatial dimensions of the activation of that channel. The occlusion map corresponds to the difference between the total activation of the original data with no occlusion and the total activation for the occluded data. Areas in the map with higher positive values correspond to regions of input data that contribute positively to the specified channel activation.

If `channels` is specified as a vector, the change in total activation for each specified channel is calculated independently. In that case, `activationMap(:, :, i)` corresponds to the occlusion map for the `i`th element in `channel`.

## See Also

`activations` | `classify`

### Topics

[“Understand Network Predictions Using Occlusion”](#)

[“Grad-CAM Reveals the Why Behind Deep Learning Decisions”](#)

[“Investigate Network Predictions Using Class Activation Mapping”](#)

[“Visualize Features of a Convolutional Neural Network”](#)

[“Visualize Activations of a Convolutional Neural Network”](#)

**Introduced in R2019b**

## partitionByIndex

Partition augmentedImageDatastore according to indices

### Syntax

```
auimds2 = partitionByIndex(auimds,ind)
```

### Description

`auimds2 = partitionByIndex(auimds,ind)` partitions a subset of observations in an augmented image datastore, `auimds`, into a new datastore, `auimds2`. The desired observations are specified by indices, `ind`.

### Input Arguments

**auimds** — Augmented image datastore

augmentedImageDatastore

Augmented image datastore, specified as an augmentedImageDatastore object.

**ind** — Indices

vector of positive integers

Indices of observations, specified as a vector of positive integers.

### Output Arguments

**auimds2** — Output datastore

augmentedImageDatastore object

Output datastore, returned as an augmentedImageDatastore object containing a subset of files from `auimds`.

### See Also

[read](#) | [readByIndex](#) | [readall](#)

**Introduced in R2018a**

# PlaceholderLayer

Layer replacing an unsupported Keras layer, ONNX layer, or unsupported functionality from `functionToLayerGraph`

## Description

`PlaceholderLayer` is a layer that `importKerasLayers` and `importONNXLayers` insert into a layer array or layer graph in place of an unsupported Keras or ONNX layer. It can also represent unsupported functionality from `functionToLayerGraph`.

## Creation

Importing layers from a Keras or ONNX network that has layers that are not supported by Deep Learning Toolbox creates `PlaceholderLayer` objects. Also, when you create a layer graph using `functionToLayerGraph`, unsupported functionality leads to `PlaceholderLayer` objects.

## Properties

### Name — Layer name

character vector | string scalar

Layer name, specified as a character vector or a string scalar.

Data Types: `char` | `string`

### Description — Layer description

character vector | string scalar

Layer description, specified as a character vector or a string scalar.

Data Types: `char` | `string`

### Type — Layer type

character vector | string scalar

Layer type, specified as a character vector or a string scalar.

Data Types: `char` | `string`

### KerasConfiguration — Keras configuration of layer

structure

Keras configuration of a layer, specified as a structure. The fields of the structure depend on the layer type.

---

**Note** This property only exists if the layer was created when importing a Keras network.

---

Data Types: `struct`

### ONNXNode — ONNX configuration of layer

structure

ONNX configuration of a layer, specified as a structure. The fields of the structure depend on the layer type.

---

**Note** This property only exists if the layer was created when importing an ONNX network.

---

Data Types: struct

### Weights — Imported weights

structure

Imported weights, specified as a structure.

Data Types: struct

## Examples

### Find and Explore Placeholder Layers

Specify the Keras network file to import layers from.

```
modelfile = 'digitsDAGnetwithnoise.h5';
```

Import the network architecture. The network includes some layer types that are not supported by Deep Learning Toolbox. The `importKerasLayers` function replaces each unsupported layer with a placeholder layer and returns a warning message.

```
lgraph = importKerasLayers(modelfile)
```

```
Warning: Unable to import some Keras layers, because they are not yet supported by the Deep Learning Toolbox. They have been replaced by placeholder layers. To find these layers, call the function findPlaceholderLayers on the returned object.
> In nnet.internal.cnn.keras.importKerasLayers (line 26)
   In importKerasLayers (line 102)
```

```
lgraph =
  LayerGraph with properties:
    Layers: [15x1 nnet.cnn.layer.Layer]
    Connections: [15x2 table]
```

Display the imported layers of the network. Two placeholder layers replace the Gaussian noise layers in the Keras network.

```
lgraph.Layers
```

```
ans =
  15x1 Layer array with layers:
   1 'input_1'           Image Input           28x28x1 images
   2 'conv2d_1'         Convolution           20 7x7 convolutions with stride [1 1] and padding 'same'
   3 'conv2d_1_relu'    ReLU                  ReLU
   4 'conv2d_2'         Convolution           20 3x3 convolutions with stride [1 1] and padding 'same'
   5 'conv2d_2_relu'    ReLU                  ReLU
   6 'gaussian_noise_1' PLACEHOLDER LAYER    Placeholder for 'GaussianNoise' Keras layer
   7 'gaussian_noise_2' PLACEHOLDER LAYER    Placeholder for 'GaussianNoise' Keras layer
   8 'max_pooling2d_1' Max Pooling           2x2 max pooling with stride [2 2] and padding 'same'
```



```

 9 'max_pooling2d_2'      Max Pooling      2x2 max pooling with stride [2 2] and padding 'same'
10 'flatten_1'          Keras Flatten   Flatten activations into 1D assuming C-style (row-major) order
11 'flatten_2'          Keras Flatten   Flatten activations into 1D assuming C-style (row-major) order
12 'concatenate_1'      Depth concatenation Depth concatenation of 2 inputs
13 'dense_1'            Fully Connected 10 fully connected layer
14 'activation_1_softmax' Softmax          softmax
15 'ClassificationLayer_activation_1' Classification Output crossentropyex

```

Find the placeholder layers using `findPlaceholderLayers`. The output argument contains the two placeholder layers that `importKerasLayers` inserted in place of the Gaussian noise layers of the Keras network.

```
placeholders = findPlaceholderLayers(lgraph)
```

```
placeholders =
```

```
2x1 PlaceholderLayer array with layers:
```

```

 1 'gaussian_noise_1'  PLACEHOLDER LAYER Placeholder for 'GaussianNoise' Keras layer
 2 'gaussian_noise_2'  PLACEHOLDER LAYER Placeholder for 'GaussianNoise' Keras layer

```

Display the configuration of each placeholder layer.

```
gaussian1.KerasConfiguration
gaussian2.KerasConfiguration
```

```
ans =
```

```
struct with fields:
```

```

trainable: 1
  name: 'gaussian_noise_1'
  stddev: 1.5000

```

```
ans =
```

```
struct with fields:
```

```

trainable: 1
  name: 'gaussian_noise_2'
  stddev: 0.7000

```

## Assemble Network from Pretrained Keras Layers

This example shows how to import the layers from a pretrained Keras network, replace the unsupported layers with custom layers, and assemble the layers into a network ready for prediction.

### Import Keras Network

Import the layers from a Keras network model. The network in `'digitsDAGnetwithnoise.h5'` classifies images of digits.

```
filename = 'digitsDAGnetwithnoise.h5';
lgraph = importKerasLayers(filename, 'ImportWeights', true);
```

Warning: Unable to import some Keras layers, because they are not yet supported by the Deep Learning Toolbox.

The Keras network contains some layers that are not supported by Deep Learning Toolbox. The `importKerasLayers` function displays a warning and replaces the unsupported layers with placeholder layers.

Plot the layer graph using `plot`.

```
figure
plot(lgraph)
title("Imported Network")
```

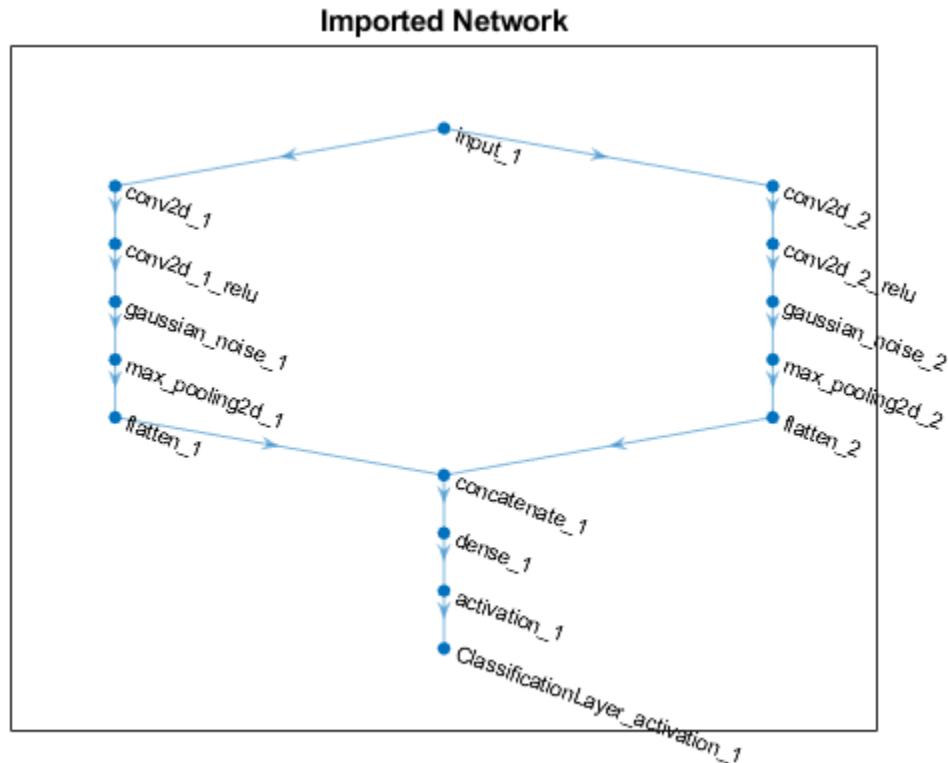

### Replace Placeholder Layers

To replace the placeholder layers, first identify the names of the layers to replace. Find the placeholder layers using `findPlaceholderLayers`.

```
placeholderLayers = findPlaceholderLayers(lgraph)
```

```
placeholderLayers =
    2x1 PlaceholderLayer array with layers:
```

```
    1 'gaussian_noise_1'  PLACEHOLDER LAYER  Placeholder for 'GaussianNoise' Keras layer
    2 'gaussian_noise_2'  PLACEHOLDER LAYER  Placeholder for 'GaussianNoise' Keras layer
```

Display the Keras configurations of these layers.

```
placeholderLayers.KerasConfiguration
```

```
ans = struct with fields:
    trainable: 1
```

```

        name: 'gaussian_noise_1'
        stddev: 1.5000

ans = struct with fields:
    trainable: 1
        name: 'gaussian_noise_2'
        stddev: 0.7000

```

Define a custom Gaussian noise layer. To create this layer, save the file `gaussianNoiseLayer.m` in the current folder. Then, create two Gaussian noise layers with the same configurations as the imported Keras layers.

```

gnLayer1 = gaussianNoiseLayer(1.5, 'new_gaussian_noise_1');
gnLayer2 = gaussianNoiseLayer(0.7, 'new_gaussian_noise_2');

```

Replace the placeholder layers with the custom layers using `replaceLayer`.

```

lgraph = replaceLayer(lgraph, 'gaussian_noise_1', gnLayer1);
lgraph = replaceLayer(lgraph, 'gaussian_noise_2', gnLayer2);

```

Plot the updated layer graph using `plot`.

```

figure
plot(lgraph)
title("Network with Replaced Layers")

```

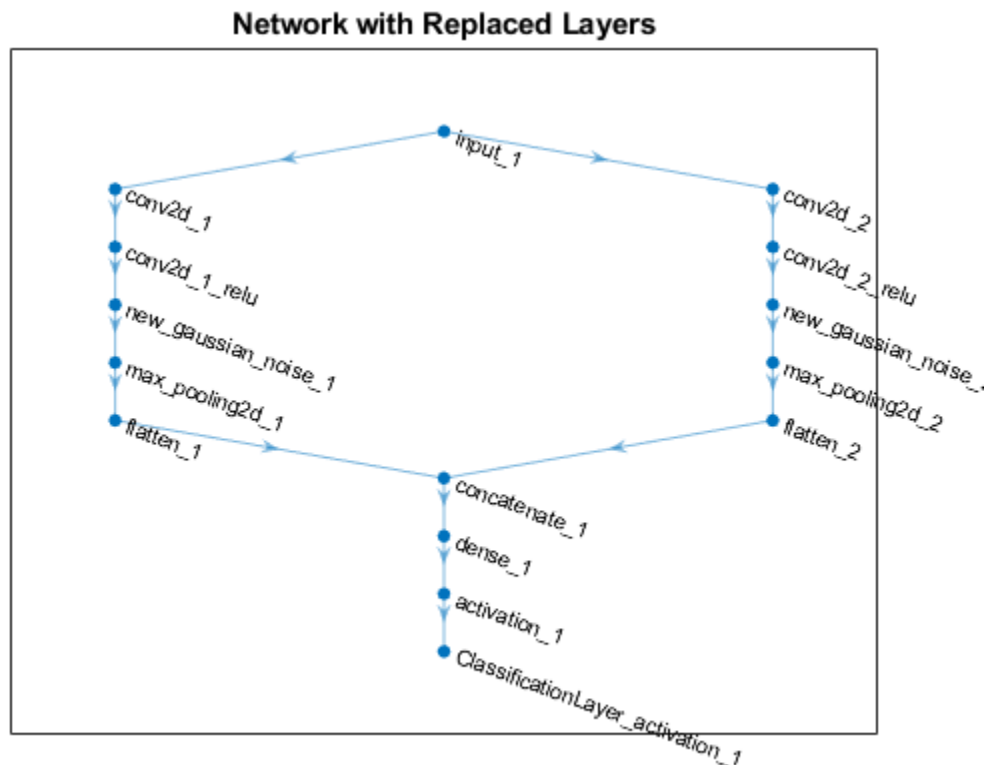

## Specify Class Names

If the imported classification layer does not contain the classes, then you must specify these before prediction. If you do not specify the classes, then the software automatically sets the classes to 1, 2, ..., N, where N is the number of classes.

Find the index of the classification layer by viewing the Layers property of the layer graph.

```
lgraph.Layers
```

```
ans =
  15x1 Layer array with layers:

     1  'input_1'           Image Input           28x28x1 images
     2  'conv2d_1'         Convolution           20 7x7x1 convolutions with
     3  'conv2d_1_relu'    ReLU                  ReLU
     4  'conv2d_2'         Convolution           20 3x3x1 convolutions with
     5  'conv2d_2_relu'    ReLU                  ReLU
     6  'new_gaussian_noise_1' Gaussian Noise         Gaussian noise with standa
     7  'new_gaussian_noise_2' Gaussian Noise         Gaussian noise with standa
     8  'max_pooling2d_1'  Max Pooling           2x2 max pooling with stride
     9  'max_pooling2d_2'  Max Pooling           2x2 max pooling with stride
    10  'flatten_1'        Keras Flatten         Flatten activations into 1
    11  'flatten_2'        Keras Flatten         Flatten activations into 1
    12  'concatenate_1'    Depth concatenation    Depth concatenation of 2 in
    13  'dense_1'          Fully Connected        10 fully connected layer
    14  'activation_1'     Softmax                softmax
    15  'ClassificationLayer_activation_1' Classification Output  crossentropyex
```

The classification layer has the name 'ClassificationLayer\_activation\_1'. View the classification layer and check the Classes property.

```
cLayer = lgraph.Layers(end)
```

```
cLayer =
  ClassificationOutputLayer with properties:

      Name: 'ClassificationLayer_activation_1'
      Classes: 'auto'
      OutputSize: 'auto'

  Hyperparameters
      LossFunction: 'crossentropyex'
```

Because the Classes property of the layer is 'auto', you must specify the classes manually. Set the classes to 0, 1, ..., 9, and then replace the imported classification layer with the new one.

```
cLayer.Classes = string(0:9)
```

```
cLayer =
  ClassificationOutputLayer with properties:

      Name: 'ClassificationLayer_activation_1'
      Classes: [0 1 2 3 4 5 6 7 8 9]
      OutputSize: 10

  Hyperparameters
```

```
LossFunction: 'crossentropyex'
```

```
lgraph = replaceLayer(lgraph, 'ClassificationLayer_activation_1', cLayer);
```

### Assemble Network

Assemble the layer graph using `assembleNetwork`. The function returns a `DAGNetwork` object that is ready to use for prediction.

```
net = assembleNetwork(lgraph)
```

```
net =
```

```
  DAGNetwork with properties:
```

```
    Layers: [15x1 nnet.cnn.layer.Layer]
 Connections: [15x2 table]
  InputNames: {'input_1'}
 OutputNames: {'ClassificationLayer_activation_1'}
```

### See Also

[assembleNetwork](#) | [findPlaceholderLayers](#) | [functionToLayerGraph](#) | [importKerasLayers](#) | [importONNXLayers](#)

### Topics

“List of Deep Learning Layers”

“Define Custom Deep Learning Layers”

“Define Custom Deep Learning Layer with Learnable Parameters”

“Check Custom Layer Validity”

“Assemble Network from Pretrained Keras Layers”

### Introduced in R2017b

## plot

Plot neural network layer graph

### Syntax

```
plot(lgraph)
plot(net)
```

### Description

`plot(lgraph)` plots a diagram of the layer graph `lgraph`. The `plot` function labels each layer by its name and displays all layer connections.

---

**Tip** To analyze the network architecture and create an interactive network visualization, use `analyzeNetwork`.

---

`plot(net)` plots a diagram of the network `net`.

### Examples

#### Plot Layer Graph

Create a layer graph from an array of layers. Connect the 'relu\_1' layer to the 'add' layer.

```
layers = [
    imageInputLayer([32 32 3], 'Name', 'input')
    convolution2dLayer(3,16, 'Padding', 'same', 'Name', 'conv_1')
    batchNormalizationLayer('Name', 'BN_1')
    reluLayer('Name', 'relu_1')

    convolution2dLayer(3,16, 'Padding', 'same', 'Stride', 2, 'Name', 'conv_2')
    batchNormalizationLayer('Name', 'BN_2')
    reluLayer('Name', 'relu_2')
    additionLayer(2, 'Name', 'add')];

lgraph = layerGraph(layers);
lgraph = connectLayers(lgraph, 'relu_1', 'add/in2');
```

Plot the layer graph.

```
figure
plot(lgraph);
```

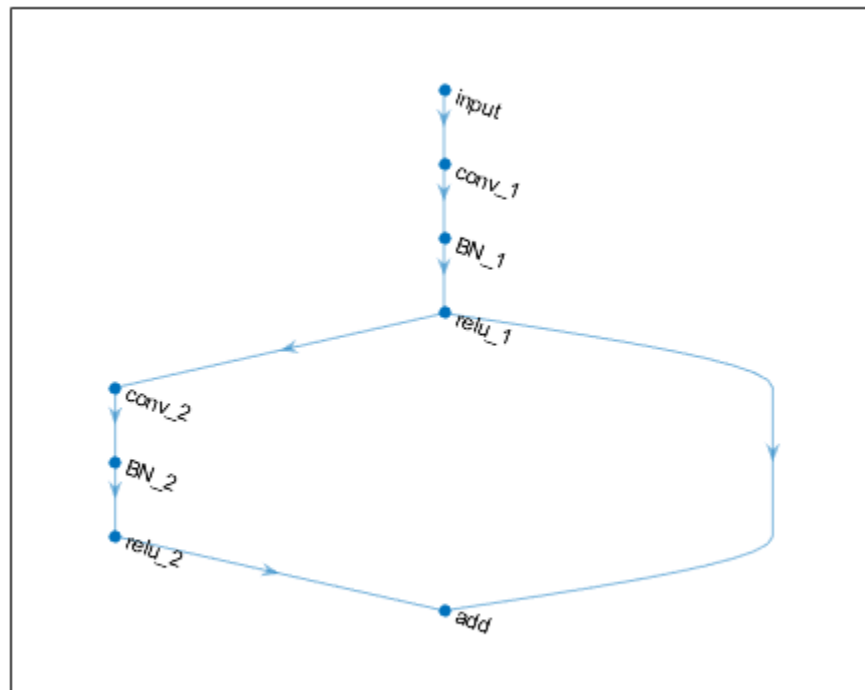

### Plot DAG Network

Load a pretrained GoogLeNet convolutional neural network as a DAGNetwork object. If the Deep Learning Toolbox™ Model for GoogLeNet Network support package is not installed, then the software provides a download link.

```
net = googlenet
```

```
net =
```

```
DAGNetwork with properties:
```

```
Layers: [144×1 nnet.cnn.layer.Layer]
```

```
Connections: [170×2 table]
```

Plot the network.

```
figure('Units','normalized','Position',[0.1 0.1 0.8 0.8]);
plot(net)
```





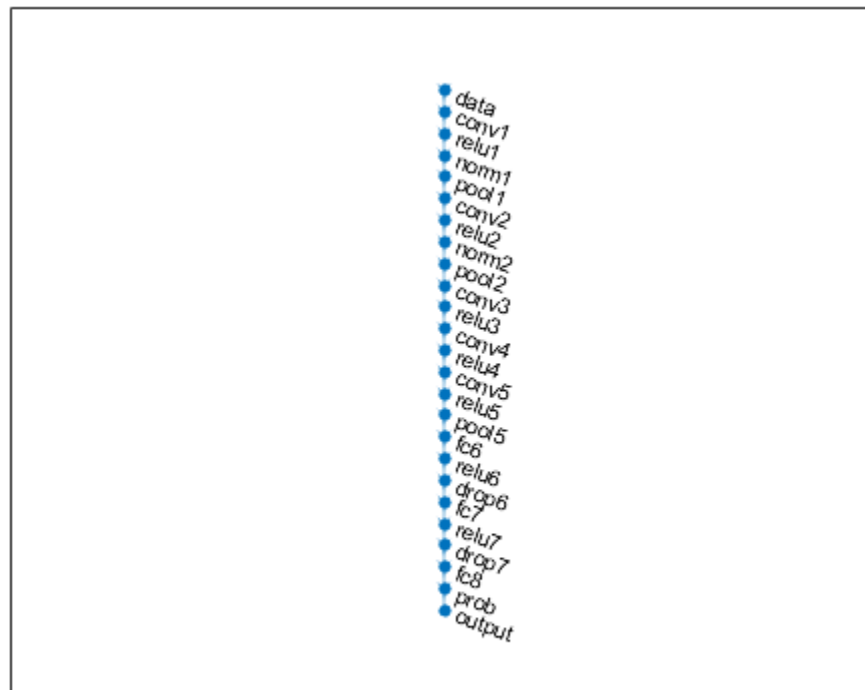

## Input Arguments

### **lgraph** — Layer graph

LayerGraph object

Layer graph, specified as a LayerGraph object. To create a layer graph, use `layerGraph`.

### **net** — Network architecture

SeriesNetwork object | DagNetworkobject

Network architecture, specified as a SeriesNetwork or a DAGNetwork object.

## See Also

`addLayers` | `analyzeNetwork` | `connectLayers` | `disconnectLayers` | `layerGraph` | `removeLayers` | `replaceLayer`

## Topics

“Train Residual Network for Image Classification”

“Train Deep Learning Network to Classify New Images”

**Introduced in R2017b**

## predict

Predict responses using a trained deep learning neural network

### Syntax

```
YPred = predict(net,imds)
YPred = predict(net,ds)
YPred = predict(net,X)
YPred = predict(net,tbl)

[YPred1,...,YPredM] = predict( ___ )

YPred = predict(net,sequences)

___ = predict( ___,Name,Value)
```

### Description

You can make predictions using a trained neural network for deep learning on either a CPU or GPU. Using a GPU requires Parallel Computing Toolbox and a CUDA enabled NVIDIA GPU with compute capability 3.0 or higher. Specify the hardware requirements using the `ExecutionEnvironment` name-value pair argument.

`YPred = predict(net,imds)` predicts responses for the image data in `imds` using the trained `SeriesNetwork` or `DAGNetwork` object `net`. For `dlnetwork` input, see `predict`.

`YPred = predict(net,ds)` predicts responses for the data in the datastore `ds`. For networks with multiple inputs, use this syntax with a combined or transformed datastore object.

`YPred = predict(net,X)` predicts responses for the data in the numeric array `X`.

`YPred = predict(net,tbl)` predicts responses for the data in the table `tbl`.

`[YPred1,...,YPredM] = predict( ___ )` predicts responses for the `M` outputs of a multi-output network using any of the previous syntaxes. The output `YPredj` corresponds to the network output `net.OutputNames(j)`. To return categorical outputs for the classification output layers, set the `'ReturnCategorical'` option to `true`.

`YPred = predict(net,sequences)` predicts responses for the sequence or time series data in `sequences` using the trained LSTM network `net`.

`___ = predict( ___,Name,Value)` predicts responses with additional options specified by one or more name-value pair arguments.

---

**Tip** When making predictions with sequences of different lengths, the mini-batch size can impact the amount of padding added to the input data which can result in different predicted values. Try using different values to see which works best with your network. To specify mini-batch size and padding options, use the `'MiniBatchSize'` and `'SequenceLength'` options.

---

## Examples

### Predict Output Scores Using a Trained ConvNet

Load the sample data.

```
[XTrain,YTrain] = digitTrain4DArrayData;
```

`digitTrain4DArrayData` loads the digit training set as 4-D array data. `XTrain` is a 28-by-28-by-1-by-5000 array, where 28 is the height and 28 is the width of the images. 1 is the number of channels and 5000 is the number of synthetic images of handwritten digits. `YTrain` is a categorical vector containing the labels for each observation.

Construct the convolutional neural network architecture.

```
layers = [ ...
    imageInputLayer([28 28 1])
    convolution2dLayer(5,20)
    reluLayer
    maxPooling2dLayer(2,'Stride',2)
    fullyConnectedLayer(10)
    softmaxLayer
    classificationLayer];
```

Set the options to default settings for the stochastic gradient descent with momentum.

```
options = trainingOptions('sgdm');
```

Train the network.

```
rng('default')
net = trainNetwork(XTrain,YTrain,layers,options);
```

Training on single CPU.

Initializing input data normalization.

Epoch	Iteration	Time Elapsed (hh:mm:ss)	Mini-batch Accuracy	Mini-batch Loss	Base Learning Rate
1	1	00:00:00	10.16%	2.3195	0.0100
2	50	00:00:06	50.78%	1.7102	0.0100
3	100	00:00:13	63.28%	1.1632	0.0100
4	150	00:00:18	60.16%	1.0859	0.0100
6	200	00:00:25	68.75%	0.8996	0.0100
7	250	00:00:30	76.56%	0.7919	0.0100
8	300	00:00:36	73.44%	0.8411	0.0100
9	350	00:00:41	81.25%	0.5514	0.0100
11	400	00:00:45	90.63%	0.4744	0.0100
12	450	00:00:49	92.19%	0.3614	0.0100
13	500	00:00:53	94.53%	0.3159	0.0100
15	550	00:00:58	96.09%	0.2543	0.0100
16	600	00:01:02	92.19%	0.2765	0.0100
17	650	00:01:07	95.31%	0.2461	0.0100
18	700	00:01:11	99.22%	0.1418	0.0100
20	750	00:01:16	98.44%	0.1000	0.0100
21	800	00:01:20	98.44%	0.1448	0.0100
22	850	00:01:25	98.44%	0.0989	0.0100

24	900	00:01:29	96.88%	0.1316	0.0100
25	950	00:01:33	100.00%	0.0859	0.0100
26	1000	00:01:37	100.00%	0.0701	0.0100
27	1050	00:01:42	100.00%	0.0759	0.0100
29	1100	00:01:46	99.22%	0.0663	0.0100
30	1150	00:01:50	98.44%	0.0775	0.0100
30	1170	00:01:52	99.22%	0.0732	0.0100

Run the trained network on a test set and predict the scores.

```
[XTest,YTest] = digitTest4DArrayData;
YPred = predict(net,XTest);
```

`predict`, by default, uses a CUDA® enabled GPU with compute capability 3.0, when available. You can also choose to run `predict` on a CPU using the 'ExecutionEnvironment', 'cpu' name-value pair argument.

Display the first 10 images in the test data and compare to the predictions from `predict`.

```
YTest(1:10,:)
```

```
ans = 10x1 categorical
    0
    0
    0
    0
    0
    0
    0
    0
    0
    0
```

```
YPred(1:10,:)
```

```
ans = 10x10 single matrix
    0.9978    0.0001    0.0008    0.0002    0.0003    0.0000    0.0004    0.0000    0.0002    0.0000
    0.8883    0.0000    0.0472    0.0001    0.0000    0.0002    0.0029    0.0001    0.0014    0.0000
    0.9998    0.0000    0.0000    0.0000    0.0000    0.0000    0.0000    0.0000    0.0000    0.0000
    0.9814    0.0000    0.0000    0.0000    0.0000    0.0000    0.0046    0.0000    0.0011    0.0000
    0.9748    0.0000    0.0132    0.0003    0.0000    0.0000    0.0002    0.0004    0.0112    0.0000
    0.9872    0.0000    0.0001    0.0000    0.0000    0.0000    0.0007    0.0000    0.0072    0.0000
    0.9981    0.0000    0.0000    0.0000    0.0000    0.0000    0.0018    0.0000    0.0000    0.0000
    1.0000    0.0000    0.0000    0.0000    0.0000    0.0000    0.0000    0.0000    0.0000    0.0000
    0.9270    0.0000    0.0046    0.0000    0.0006    0.0009    0.0001    0.0000    0.0018    0.0000
    0.9328    0.0000    0.0139    0.0012    0.0001    0.0001    0.0378    0.0000    0.0110    0.0000
```

`YTest` contains the digits corresponding to the images in `XTest`. The columns of `YPred` contain `predict`'s estimation of a probability that an image contains a particular digit. That is, the first column contains the probability estimate that the given image is digit 0, the second column contains the probability estimate that the image is digit 1, the third column contains the probability estimate that the image is digit 2, and so on. You can see that `predict`'s estimation of probabilities for the correct digits are almost 1 and the probability for any other digit is almost 0. `predict` correctly estimates the first 10 observations as digit 0.

## Predict Output Scores Using a Trained LSTM Network

Load pretrained network. `JapaneseVowelsNet` is a pretrained LSTM network trained on the Japanese Vowels dataset as described in [1] and [2]. It was trained on the sequences sorted by sequence length with a mini-batch size of 27.

load `JapaneseVowelsNet`

View the network architecture.

`net.Layers`

```
ans =
  5x1 Layer array with layers:

   1  'sequenceinput'  Sequence Input          Sequence input with 12 dimensions
   2  'lstm'          LSTM                   LSTM with 100 hidden units
   3  'fc'            Fully Connected       9 fully connected layer
   4  'softmax'      Softmax                softmax
   5  'classoutput'  Classification Output  crossentropyex with '1' and 8 other classes
```

Load the test data.

```
[XTest,YTest] = japaneseVowelsTestData;
```

Make predictions on the test data.

```
YPred = predict(net,XTest);
```

View the prediction scores for the first 10 sequences.

```
YPred(1:10,:)
```

```
ans = 10x9 single matrix
```

```

0.9918    0.0000    0.0000    0.0000    0.0006    0.0010    0.0001    0.0006    0.0059
0.9868    0.0000    0.0000    0.0000    0.0006    0.0010    0.0001    0.0010    0.0105
0.9924    0.0000    0.0000    0.0000    0.0006    0.0010    0.0001    0.0006    0.0054
0.9896    0.0000    0.0000    0.0000    0.0006    0.0009    0.0001    0.0007    0.0080
0.9965    0.0000    0.0000    0.0000    0.0007    0.0009    0.0000    0.0003    0.0016
0.9888    0.0000    0.0000    0.0000    0.0006    0.0010    0.0001    0.0008    0.0087
0.9886    0.0000    0.0000    0.0000    0.0006    0.0010    0.0001    0.0008    0.0089
0.9982    0.0000    0.0000    0.0000    0.0006    0.0007    0.0000    0.0001    0.0004
0.9883    0.0000    0.0000    0.0000    0.0006    0.0010    0.0001    0.0008    0.0093
0.9959    0.0000    0.0000    0.0000    0.0007    0.0011    0.0000    0.0004    0.0019
```

Compare these prediction scores to the labels of these sequences. The function assigns high prediction scores to the correct class.

```
YTest(1:10)
```

```
ans = 10x1 categorical
```

```

1
1
1
```

```
1  
1  
1  
1  
1  
1  
1  
1
```

## Input Arguments

### **net** — Trained network

SeriesNetwork object | DAGNetwork object

Trained network, specified as a `SeriesNetwork` or a `DAGNetwork` object. You can get a trained network by importing a pretrained network (for example, by using the `googlenet` function) or by training your own network using `trainNetwork`.

### **imds** — Image datastore

ImageDatastore object

Image datastore, specified as an `ImageDatastore` object.

`ImageDatastore` allows batch reading of JPG or PNG image files using prefetching. If you use a custom function for reading the images, then `ImageDatastore` does not prefetch.

---

**Tip** Use `augmentedImageDatastore` for efficient preprocessing of images for deep learning including image resizing.

---

Do not use the `readFcn` option of `imageDatastore` as this option is usually significantly slower.

---

### **ds** — Datastore

datastore

Datastore of input data.

For networks with a single input, `ds` can return either:

- a single image or sequence
- a cell array of images or sequences
- a table, where the first column contains images or sequences

For networks with multiple image inputs layers, `ds` must be a combined or transformed datastore that returns a cell array with `numInputs` columns containing the input data, where `numInputs` is the number of network inputs. The `i`th element of the cell array corresponds to the input `net.InputNames(i)`.

For more information, see “Datastores for Deep Learning”.

### **X** — Image data

numeric array

Image data, specified as a numeric array. The size of the array depends on the type of image input:

Input	Description
2-D images	A $h$ -by- $w$ -by- $c$ -by- $N$ numeric array, where $h$ , $w$ , and $c$ are the height, width, and number of channels of the images, respectively, and $N$ is the number of images.
3-D images	A $h$ -by- $w$ -by- $d$ -by- $c$ -by- $N$ numeric array, where $h$ , $w$ , $d$ , and $c$ are the height, width, depth, and number of channels of the images, respectively, and $N$ is the number of images.

If the array contains NaNs, then they are propagated through the network.

### sequences — Sequence or time series data

cell array of numeric arrays | numeric array | datastore

Sequence or time series data, specified as an  $N$ -by-1 cell array of numeric arrays, where  $N$  is the number of observations, a numeric array representing a single sequence, or a datastore.

For cell array or numeric array input, the dimensions of the numeric arrays containing the sequences depend on the type of data.

Input	Description
Vector sequences	$c$ -by- $s$ matrices, where $c$ is the number of features of the sequences and $s$ is the sequence length.
2-D image sequences	$h$ -by- $w$ -by- $c$ -by- $s$ arrays, where $h$ , $w$ , and $c$ correspond to the height, width, and number of channels of the images, respectively, and $s$ is the sequence length.
3-D image sequences	$h$ -by- $w$ -by- $d$ -by- $c$ -by- $s$ , where $h$ , $w$ , $d$ , and $c$ correspond to the height, width, depth, and number of channels of the 3-D images, respectively, and $s$ is the sequence length.

For datastore input, the datastore must return data as a cell array of sequences or a table whose first column contains sequences. The dimensions of the sequence data must correspond to the table above.

### tbl — Table of images

table

Table of images containing the input data in the first column. Each row in the table corresponds to an observation. The table contains absolute or relative file paths to an image, specified as a character vector or images specified as a numeric array.

Data Types: table

### Name-Value Pair Arguments

Specify optional comma-separated pair of Name, Value argument. Name is the argument name and Value is the corresponding value. Name must appear inside single quotes ( ' ' ).

Example: 'MiniBatchSize', 256 specifies the mini-batch size as 256.

**MiniBatchSize — Size of mini-batches**

128 (default) | positive integer

Size of mini-batches to use for prediction, specified as a positive integer. Larger mini-batch sizes require more memory, but can lead to faster predictions.

When making predictions with sequences of different lengths, the mini-batch size can impact the amount of padding added to the input data which can result in different predicted values. Try using different values to see which works best with your network. To specify mini-batch size and padding options, use the 'MiniBatchSize' and 'SequenceLength' options.

Example: 'MiniBatchSize',256

**Acceleration — Performance optimization**

'auto' (default) | 'mex' | 'none'

Performance optimization, specified as the comma-separated pair consisting of 'Acceleration' and one of the following:

- 'auto' — Automatically apply a number of optimizations suitable for the input network and hardware resource.
- 'mex' — Compile and execute a MEX function. This option is available when using a GPU only. Using a GPU requires Parallel Computing Toolbox and a CUDA enabled NVIDIA GPU with compute capability 3.0 or higher. If Parallel Computing Toolbox or a suitable GPU is not available, then the software returns an error.
- 'none' — Disable all acceleration.

The default option is 'auto'. If 'auto' is specified, MATLAB will apply a number of compatible optimizations. If you use the 'auto' option, MATLAB does not ever generate a MEX function.

Using the 'Acceleration' options 'auto' and 'mex' can offer performance benefits, but at the expense of an increased initial run time. Subsequent calls with compatible parameters are faster. Use performance optimization when you plan to call the function multiple times using new input data.

The 'mex' option generates and executes a MEX function based on the network and parameters used in the function call. You can have several MEX functions associated with a single network at one time. Clearing the network variable also clears any MEX functions associated with that network.

The 'mex' option is only available when you are using a GPU. You must have a C/C++ compiler installed and the GPU Coder Interface for Deep Learning Libraries support package. Install the support package using the Add-On Explorer in MATLAB. For setup instructions, see “MEX Setup” (GPU Coder). GPU Coder is not required.

The 'mex' option does not support all layers. For a list of supported layers, see “Supported Layers” (GPU Coder). Recurrent neural networks (RNNs) containing a `sequenceInputLayer` are not supported.

You cannot use MATLAB Compiler to deploy your network when using the 'mex' option.

Example: 'Acceleration','mex'

**ExecutionEnvironment — Hardware resource**

'auto' (default) | 'gpu' | 'cpu'



Hardware resource, specified as the comma-separated pair consisting of 'ExecutionEnvironment' and one of the following:

- 'auto' — Use a GPU if one is available; otherwise, use the CPU.
- 'gpu' — Use the GPU. Using a GPU requires Parallel Computing Toolbox and a CUDA enabled NVIDIA GPU with compute capability 3.0 or higher. If Parallel Computing Toolbox or a suitable GPU is not available, then the software returns an error.
- 'cpu' — Use the CPU.

Example: 'ExecutionEnvironment','cpu'

### **ReturnCategorical — Option to return categorical labels**

false (default) | true

Option to return categorical labels, specified as true or false.

If ReturnCategorical is true, then the function returns categorical labels for classification output layers. Otherwise, the function returns the prediction scores for classification output layers.

### **SequenceLength — Option to pad, truncate, or split input sequences**

'longest' (default) | 'shortest' | positive integer

Option to pad, truncate, or split input sequences, specified as one of the following:

- 'longest' — Pad sequences in each mini-batch to have the same length as the longest sequence. This option does not discard any data, though padding can introduce noise to the network.
- 'shortest' — Truncate sequences in each mini-batch to have the same length as the shortest sequence. This option ensures that no padding is added, at the cost of discarding data.
- Positive integer — For each mini-batch, pad the sequences to the nearest multiple of the specified length that is greater than the longest sequence length in the mini-batch, and then split the sequences into smaller sequences of the specified length. If splitting occurs, then the software creates extra mini-batches. Use this option if the full sequences do not fit in memory. Alternatively, try reducing the number of sequences per mini-batch by setting the 'MiniBatchSize' option to a lower value.

To learn more about the effect of padding, truncating, and splitting the input sequences, see “Sequence Padding, Truncation, and Splitting”.

Example: 'SequenceLength','shortest'

### **SequencePaddingDirection — Direction of padding or truncation**

'right' (default) | 'left'

Direction of padding or truncation, specified as one of the following:

- 'right' — Pad or truncate sequences on the right. The sequences start at the same time step and the software truncates or adds padding to the end of the sequences.
- 'left' — Pad or truncate sequences on the left. The software truncates or adds padding to the start of the sequences so that the sequences end at the same time step.

Because LSTM layers process sequence data one time step at a time, when the layer OutputMode property is 'last', any padding in the final time steps can negatively influence the layer output. To pad or truncate sequence data on the left, set the 'SequencePaddingDirection' option to 'left'.

For sequence-to-sequence networks (when the `OutputMode` property is 'sequence' for each LSTM layer), any padding in the first time steps can negatively influence the predictions for the earlier time steps. To pad or truncate sequence data on the right, set the 'SequencePaddingDirection' option to 'right'.

To learn more about the effect of padding, truncating, and splitting the input sequences, see “Sequence Padding, Truncation, and Splitting”.

### SequencePaddingValue — Value to pad input sequences

0 (default) | scalar

Value by which to pad input sequences, specified as a scalar. The option is valid only when `SequenceLength` is 'longest' or a positive integer. Do not pad sequences with NaN, because doing so can propagate errors throughout the network.

Example: 'SequencePaddingValue', -1

## Output Arguments

### YPred — Predicted scores or responses

matrix | 4-D numeric array | cell array of matrices

Predicted scores or responses, returned as a matrix, a 4-D numeric array, or a cell array of matrices. The format of `YPred` depends on the type of problem.

The following table describes the format for classification problems.

Task	Format
Image classification	$N$ -by- $K$ matrix, where $N$ is the number of observations, and $K$ is the number of classes
Sequence-to-label classification	
Sequence-to-sequence classification	$N$ -by-1 cell array of matrices, where $N$ is the number of observations. The sequences are matrices with $K$ rows, where $K$ is the number of classes. Each sequence has the same number of time steps as the corresponding input sequence after applying the <code>SequenceLength</code> option to each mini-batch independently.

The following table describes the format for regression problems.

Task	Format
2-D image regression	<ul style="list-style-type: none"> <li><math>N</math>-by-<math>R</math> matrix, where <math>N</math> is the number of images and <math>R</math> is the number of responses.</li> <li><math>h</math>-by-<math>w</math>-by-<math>c</math>-by-<math>N</math> numeric array, where <math>h</math>, <math>w</math>, and <math>c</math> are the height, width, and number of channels of the images, respectively, and <math>N</math> is the number of images.</li> </ul>

Task	Format
3-D image regression	<ul style="list-style-type: none"> <li><math>N</math>-by-<math>R</math> matrix, where <math>N</math> is the number of images and <math>R</math> is the number of responses.</li> <li><math>h</math>-by-<math>w</math>-by-<math>d</math>-by-<math>c</math>-by-<math>N</math> numeric array, where <math>h</math>, <math>w</math>, <math>d</math>, and <math>c</math> are the height, width, depth, and number of channels of the images, respectively, and <math>N</math> is the number of images.</li> </ul>
Sequence-to-one regression	$N$ -by- $R$ matrix, where $N$ is the number of sequences and $R$ is the number of responses.
Sequence-to-sequence regression	$N$ -by-1 cell array of numeric sequences, where $N$ is the number of sequences. The sequences are matrices with $R$ rows, where $R$ is the number of responses. Each sequence has the same number of time steps as the corresponding input sequence after applying the <code>SequenceLength</code> option to each mini-batch independently.

For sequence-to-sequence regression problems with one observation, sequences can be a matrix. In this case, `YPred` is a matrix of responses.

## Algorithms

If the image data contains NaNs, `predict` propagates them through the network. If the network has ReLU layers, these layers ignore NaNs. However, if the network does not have a ReLU layer, then `predict` returns NaNs as predictions.

All functions for deep learning training, prediction, and validation in Deep Learning Toolbox perform computations using single-precision, floating-point arithmetic. Functions for deep learning include `trainNetwork`, `predict`, `classify`, and `activations`. The software uses single-precision arithmetic when you train networks using both CPUs and GPUs.

## Alternatives

You can compute the predicted scores and the predicted classes from a trained network using `classify`.

You can also compute the activations from a network layer using `activations`.

For sequence-to-label and sequence-to-sequence classification networks (LSTM networks), you can make predictions and update the network state using `classifyAndUpdateState` and `predictAndUpdateState`.

## References

- [1] M. Kudo, J. Toyama, and M. Shimbo. "Multidimensional Curve Classification Using Passing-Through Regions." *Pattern Recognition Letters*. Vol. 20, No. 11-13, pages 1103-1111.
- [2] *UCI Machine Learning Repository: Japanese Vowels Dataset*. <https://archive.ics.uci.edu/ml/datasets/Japanese+Vowels>

## Extended Capabilities

### C/C++ Code Generation

Generate C and C++ code using MATLAB® Coder™.

Usage notes and limitations:

- Only the syntax `YPred = predict(net,X)` is supported.
- The input `X` must not have a variable size. The size must be fixed at code generation time.

For more information about generating code for deep learning neural networks, see “Workflow for Deep Learning Code Generation with MATLAB Coder” (MATLAB Coder).

### GPU Code Generation

Generate CUDA® code for NVIDIA® GPUs using GPU Coder™.

Usage notes and limitations:

- GPU code generation supports the following syntaxes:
  - `YPred = predict(net,X)`
  - `[YPred1,...,YPredM] = predict(__)`
  - `YPred = predict(net,sequences)`
  - `__ = predict(__,Name,Value)`
- The input `X` must not have variable size. The size must be fixed at code generation time.
- GPU code generation for the `predict` function supports inputs that are defined as half-precision floating point data types. For more information, see `half`.
- GPU code generation supports only vector sequences. The sequence length can be variable sized. The feature dimension must be fixed at code generation time.
- Only the `'MiniBatchSize'`, `'SequenceLength'`, `'SequencePaddingDirection'`, and `'SequencePaddingValue'` name-value pair arguments are supported for code generation. All name-value pairs must be compile-time constants.
- Only the `'longest'` and `'shortest'` option of the `'SequenceLength'` name-value pair is supported for code generation.

## See Also

`activations` | `classify` | `classifyAndUpdateState` | `predictAndUpdateState`

**Introduced in R2016a**

# predictAndUpdateState

Predict responses using a trained recurrent neural network and update the network state

## Syntax

```
[updatedNet,YPred] = predictAndUpdateState(recNet,sequences)
[updatedNet,YPred] = predictAndUpdateState( ____,Name,Value)
```

## Description

You can make predictions using a trained deep learning network on either a CPU or GPU. Using a GPU requires Parallel Computing Toolbox and a CUDA enabled NVIDIA GPU with compute capability 3.0 or higher. Specify the hardware requirements using the "ExecutionEnvironment" on page 1-0 name-value pair argument.

[updatedNet,YPred] = predictAndUpdateState(recNet,sequences) predicts responses for data in sequences using the trained recurrent neural network recNet and updates the network state.

This function supports recurrent neural networks only. The input recNet must have at least one recurrent layer.

[updatedNet,YPred] = predictAndUpdateState( \_\_\_\_,Name,Value) uses any of the arguments in the previous syntaxes and additional options specified by one or more Name,Value pair arguments. For example, 'MiniBatchSize',27 makes predictions using mini-batches of size 27.

---

**Tip** When making predictions with sequences of different lengths, the mini-batch size can impact the amount of padding added to the input data which can result in different predicted values. Try using different values to see which works best with your network. To specify mini-batch size and padding options, use the 'MiniBatchSize' and 'SequenceLength' options.

---

## Examples

### Predict and Update Network State

Predict responses using a trained recurrent neural network and update the network state.

Load JapaneseVowelsNet, a pretrained long short-term memory (LSTM) network trained on the Japanese Vowels data set as described in [1] and [2]. This network was trained on the sequences sorted by sequence length with a mini-batch size of 27.

```
load JapaneseVowelsNet
```

View the network architecture.

```
net.Layers
```

```
ans =
    5x1 Layer array with layers:
```

1	'sequenceinput'	Sequence Input	Sequence input with 12 dimensions
2	'lstm'	LSTM	LSTM with 100 hidden units
3	'fc'	Fully Connected	9 fully connected layer
4	'softmax'	Softmax	softmax
5	'classoutput'	Classification Output	crossentropyex with '1' and 8 other classes

Load the test data.

```
[XTest,YTest] = japaneseVowelsTestData;
```

Loop over the time steps in a sequence. Predict the scores of each time step and update the network state.

```
X = XTest{94};
numTimeSteps = size(X,2);
for i = 1:numTimeSteps
    v = X(:,i);
    [net,score] = predictAndUpdateState(net,v);
    scores(:,i) = score;
end
```

Plot the prediction scores. The plot shows how the prediction scores change between time steps.

```
classNames = string(net.Layers(end).Classes);
figure
lines = plot(scores');
xlim([1 numTimeSteps])
legend("Class " + classNames, 'Location', 'northwest')
xlabel("Time Step")
ylabel("Score")
title("Prediction Scores Over Time Steps")
```

Highlight the prediction scores over time steps for the correct class.

```
trueLabel = YTest(94)
trueLabel = categorical
    3
```

```
lines(trueLabel).LineWidth = 3;
```

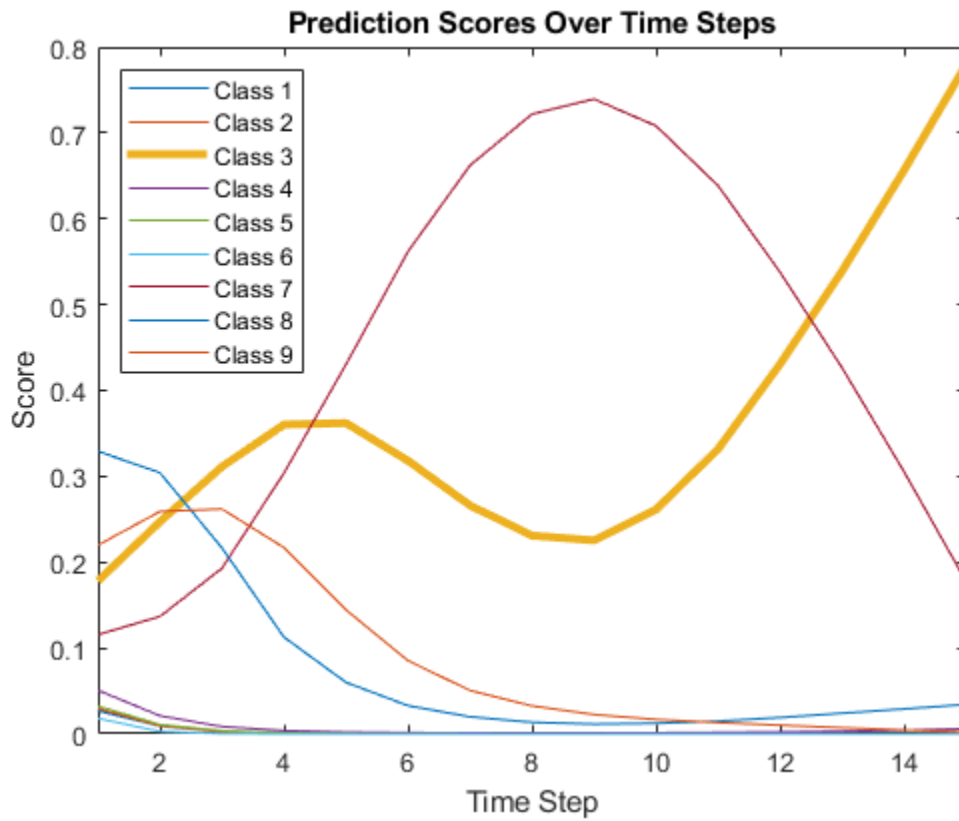

Display the final time step prediction in a bar chart.

```
figure
bar(score)
title("Final Prediction Scores")
xlabel("Class")
ylabel("Score")
```

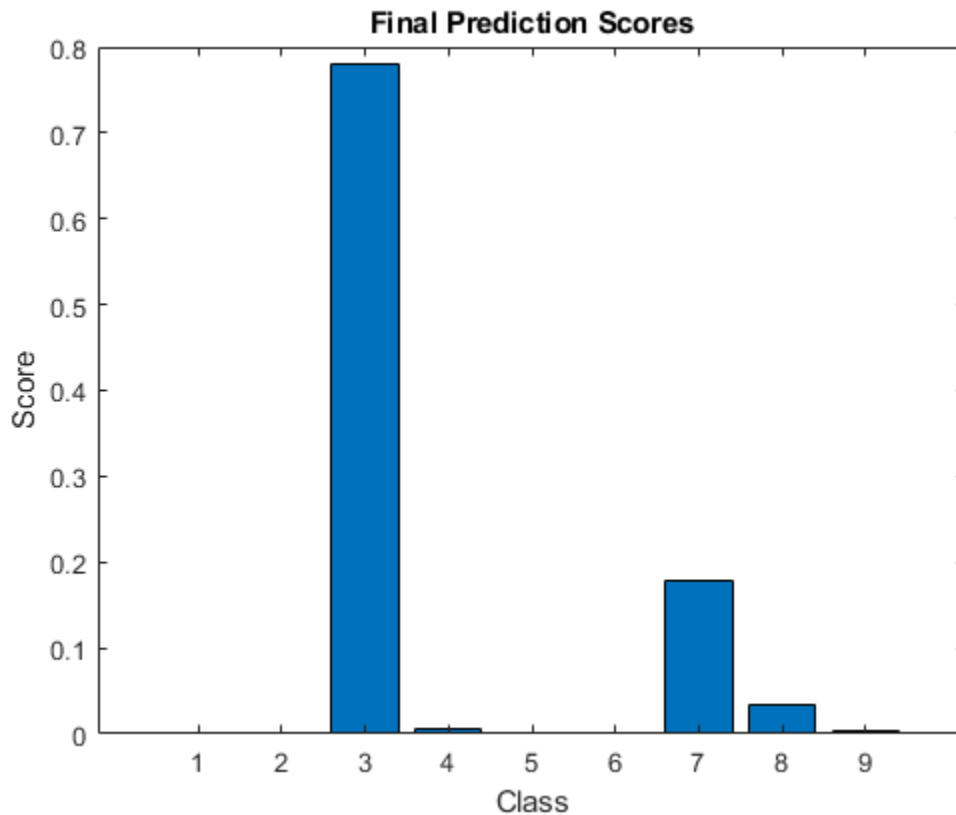

## Input Arguments

### **recNet** — Trained recurrent neural network

SeriesNetwork object | DAGNetwork object

Trained recurrent neural network, specified as a SeriesNetwork or a DAGNetwork object. You can get a trained network by importing a pretrained network or by training your own network using the trainNetwork function.

recNet is a recurrent neural network. It must have at least one recurrent layer (for example, an LSTM network).

### **sequences** — Sequence or time series data

cell array of numeric arrays | numeric array | datastore

Sequence or time series data, specified as an  $N$ -by-1 cell array of numeric arrays, where  $N$  is the number of observations, a numeric array representing a single sequence, or a datastore.

For cell array or numeric array input, the dimensions of the numeric arrays containing the sequences depend on the type of data.



Input	Description
Vector sequences	$c$ -by- $s$ matrices, where $c$ is the number of features of the sequences and $s$ is the sequence length.
2-D image sequences	$h$ -by- $w$ -by- $c$ -by- $s$ arrays, where $h$ , $w$ , and $c$ correspond to the height, width, and number of channels of the images, respectively, and $s$ is the sequence length.
3-D image sequences	$h$ -by- $w$ -by- $d$ -by- $c$ -by- $s$ , where $h$ , $w$ , $d$ , and $c$ correspond to the height, width, depth, and number of channels of the 3-D images, respectively, and $s$ is the sequence length.

For datastore input, the datastore must return data as a cell array of sequences or a table whose first column contains sequences. The dimensions of the sequence data must correspond to the table above.

### Name-Value Pair Arguments

Specify optional comma-separated pairs of `Name`, `Value` arguments. `Name` is the argument name and `Value` is the corresponding value. `Name` must appear inside quotes. You can specify several name and value pair arguments in any order as `Name1, Value1, ..., NameN, ValueN`.

Example: `[updatedNet, YPred] = predictAndUpdateState(recNet,C, 'MiniBatchSize',27)` makes predictions using mini-batches of size 27.

### MiniBatchSize — Size of mini-batches

128 (default) | positive integer

Size of mini-batches to use for prediction, specified as a positive integer. Larger mini-batch sizes require more memory, but can lead to faster predictions.

When making predictions with sequences of different lengths, the mini-batch size can impact the amount of padding added to the input data which can result in different predicted values. Try using different values to see which works best with your network. To specify mini-batch size and padding options, use the `'MiniBatchSize'` and `'SequenceLength'` options.

Example: `'MiniBatchSize',256`

### Acceleration — Performance optimization

'auto' (default) | 'none'

Performance optimization, specified as the comma-separated pair consisting of `'Acceleration'` and one of the following:

- `'auto'` — Automatically apply a number of optimizations suitable for the input network and hardware resource.
- `'none'` — Disable all acceleration.

The default option is `'auto'`.

Using the 'Acceleration' option 'auto' can offer performance benefits, but at the expense of an increased initial run time. Subsequent calls with compatible parameters are faster. Use performance optimization when you plan to call the function multiple times using new input data.

Example: 'Acceleration', 'auto'

### **ExecutionEnvironment — Hardware resource**

'auto' (default) | 'gpu' | 'cpu'

Hardware resource, specified as the comma-separated pair consisting of 'ExecutionEnvironment' and one of the following:

- 'auto' — Use a GPU if one is available; otherwise, use the CPU.
- 'gpu' — Use the GPU. Using a GPU requires Parallel Computing Toolbox and a CUDA enabled NVIDIA GPU with compute capability 3.0 or higher. If Parallel Computing Toolbox or a suitable GPU is not available, then the software returns an error.
- 'cpu' — Use the CPU.

Example: 'ExecutionEnvironment', 'cpu'

### **SequenceLength — Option to pad, truncate, or split input sequences**

'longest' (default) | 'shortest' | positive integer

Option to pad, truncate, or split input sequences, specified as one of the following:

- 'longest' — Pad sequences in each mini-batch to have the same length as the longest sequence. This option does not discard any data, though padding can introduce noise to the network.
- 'shortest' — Truncate sequences in each mini-batch to have the same length as the shortest sequence. This option ensures that no padding is added, at the cost of discarding data.
- Positive integer — For each mini-batch, pad the sequences to the nearest multiple of the specified length that is greater than the longest sequence length in the mini-batch, and then split the sequences into smaller sequences of the specified length. If splitting occurs, then the software creates extra mini-batches. Use this option if the full sequences do not fit in memory. Alternatively, try reducing the number of sequences per mini-batch by setting the 'MiniBatchSize' option to a lower value.

To learn more about the effect of padding, truncating, and splitting the input sequences, see “Sequence Padding, Truncation, and Splitting”.

Example: 'SequenceLength', 'shortest'

### **SequencePaddingDirection — Direction of padding or truncation**

'right' (default) | 'left'

Direction of padding or truncation, specified as one of the following:

- 'right' — Pad or truncate sequences on the right. The sequences start at the same time step and the software truncates or adds padding to the end of the sequences.
- 'left' — Pad or truncate sequences on the left. The software truncates or adds padding to the start of the sequences so that the sequences end at the same time step.

Because LSTM layers process sequence data one time step at a time, when the layer `OutputMode` property is 'last', any padding in the final time steps can negatively influence the layer output. To

pad or truncate sequence data on the left, set the 'SequencePaddingDirection' option to 'left'.

For sequence-to-sequence networks (when the `OutputMode` property is 'sequence' for each LSTM layer), any padding in the first time steps can negatively influence the predictions for the earlier time steps. To pad or truncate sequence data on the right, set the 'SequencePaddingDirection' option to 'right'.

To learn more about the effect of padding, truncating, and splitting the input sequences, see “Sequence Padding, Truncation, and Splitting”.

### SequencePaddingValue — Value to pad input sequences

0 (default) | scalar

Value by which to pad input sequences, specified as a scalar. The option is valid only when `SequenceLength` is 'longest' or a positive integer. Do not pad sequences with NaN, because doing so can propagate errors throughout the network.

Example: 'SequencePaddingValue', -1

## Output Arguments

### updatedNet — Updated network

SeriesNetwork object | DAGNetwork object

Updated network. `updatedNet` is the same type of network as the input network.

### YPred — Predicted scores or responses

matrix | cell array of matrices

Predicted scores or responses, returned as a matrix or a cell array of matrices. The format of `YPred` depends on the type of problem.

The following table describes the format for classification problems.

Task	Format
Sequence-to-label classification	$N$ -by- $K$ matrix, where $N$ is the number of observations, and $K$ is the number of classes.
Sequence-to-sequence classification	$N$ -by-1 cell array of matrices, where $N$ is the number of observations. The sequences are matrices with $K$ rows, where $K$ is the number of classes. Each sequence has the same number of time steps as the corresponding input sequence after applying the <code>SequenceLength</code> option to each mini-batch independently.

For sequence-to-sequence classification problems with one observation, `sequences` can be a matrix. In this case, `YPred` is a  $K$ -by- $S$  matrix of scores, where  $K$  is the number of classes, and  $S$  is the total number of time steps in the corresponding input sequence.

The following table describes the format for regression problems.

Task	Format
Sequence-to-one regression	$N$ -by- $R$ matrix, where $N$ is the number of observations and $R$ is the number of responses.
Sequence-to-sequence regression	$N$ -by-1 cell array of numeric sequences, where $N$ is the number of observations. The sequences are matrices with $R$ rows, where $R$ is the number of responses. Each sequence has the same number of time steps as the corresponding input sequence after applying the <code>SequenceLength</code> option to each mini-batch independently.

For sequence-to-sequence problems with one observation, sequences can be a matrix. In this case, `YPred` is a matrix of responses.

## Algorithms

All functions for deep learning training, prediction, and validation in Deep Learning Toolbox perform computations using single-precision, floating-point arithmetic. Functions for deep learning include `trainNetwork`, `predict`, `classify`, and `activations`. The software uses single-precision arithmetic when you train networks using both CPUs and GPUs.

## References

- [1] M. Kudo, J. Toyama, and M. Shimbo. "Multidimensional Curve Classification Using Passing-Through Regions." *Pattern Recognition Letters*. Vol. 20, No. 11-13, pages 1103-1111.
- [2] *UCI Machine Learning Repository: Japanese Vowels Dataset*. <https://archive.ics.uci.edu/ml/datasets/Japanese+Vowels>

## Extended Capabilities

### GPU Code Generation

Generate CUDA® code for NVIDIA® GPUs using GPU Coder™.

Usage notes and limitations:

- GPU code generation supports the following syntaxes:
  - `[updatedNet, YPred] = predictAndUpdateState(recNet, sequences)`
  - `[updatedNet, YPred] = predictAndUpdateState(__, Name, Value)`
- GPU code generation for the `predictAndUpdateState` function is only supported for recurrent neural networks and cuDNN target library.
- GPU code generation supports only vector sequences. The sequence length can be variable sized. The feature dimension must be fixed at code generation time.
- Only the `'MiniBatchSize'`, `'SequenceLength'`, `'SequencePaddingDirection'`, and `'SequencePaddingValue'` name-value pair arguments are supported for code generation. All name-value pairs must be compile-time constants.
- Only the `'longest'` and `'shortest'` option of the `'SequenceLength'` name-value pair is supported for code generation.

**See Also**

[bilstmLayer](#) | [classify](#) | [classifyAndUpdateState](#) | [gruLayer](#) | [lstmLayer](#) | [predict](#) | [resetState](#) | [sequenceInputLayer](#)

**Topics**

[“Sequence Classification Using Deep Learning”](#)  
[“Time Series Forecasting Using Deep Learning”](#)  
[“Sequence-to-Sequence Classification Using Deep Learning”](#)  
[“Sequence-to-Sequence Regression Using Deep Learning”](#)  
[“Visualize Activations of LSTM Network”](#)  
[“Long Short-Term Memory Networks”](#)  
[“Deep Learning in MATLAB”](#)

**Introduced in R2017b**

## read

Read data from `augmentedImageDatastore`

### Syntax

```
data = read(auimds)
[data,info] = read(auimds)
```

### Description

`data = read(auimds)` returns a batch of data from an augmented image datastore, `auimds`. Subsequent calls to the `read` function continue reading from the endpoint of the previous call.

`[data,info] = read(auimds)` also returns information about the extracted data, including metadata, in `info`.

### Input Arguments

#### **auimds** — Augmented image datastore

`augmentedImageDatastore`

Augmented image datastore, specified as an `augmentedImageDatastore` object. The datastore specifies a `MiniBatchSize` number of observations in each batch, and a `numObservations` total number of observations.

### Output Arguments

#### **data** — Output data

table

Output data, returned as a table with `MiniBatchSize` number of rows.

For the last batch of data in the datastore `auimds`, if `numObservations` is not cleanly divisible by `MiniBatchSize`, then `read` returns a partial batch containing all the remaining observations in the datastore.

#### **info** — Information about read data

structure array

Information about read data, returned as a structure array. The structure array can contain the following fields.

Field Name	Description
Filename	Filename is a fully resolved path containing the path string, name of the file, and file extension.
FileSize	Total file size, in bytes. For MAT-files, FileSize is the total number of key-value pairs in the file.

## **See Also**

read (Datastore) | readByIndex | readall

**Introduced in R2018a**

## readByIndex

Read data specified by index from `augmentedImageDatastore`

### Syntax

```
data = readByIndex(auimds,ind)
[data,info] = readByIndex(auimds,ind)
```

### Description

`data = readByIndex(auimds,ind)` returns a subset of observations from an augmented image datastore, `auimds`. The desired observations are specified by indices, `ind`.

`[data,info] = readByIndex(auimds,ind)` also returns information about the observations, including metadata, in `info`.

### Input Arguments

#### **auimds** – Augmented image datastore

`augmentedImageDatastore`

Augmented image datastore, specified as an `augmentedImageDatastore` object.

#### **ind** – Indices

vector of positive integers

Indices of observations, specified as a vector of positive integers.

### Output Arguments

#### **data** – Observations from datastore

table

Observations from the datastore, returned as a table with `length(ind)` number of rows.

#### **info** – Information about read data

structure array

Information about read data, returned as a structure array with the following fields.

Field Name	Description
MiniBatchIndices	Numeric vector of indices.

### See Also

`partitionByIndex` | `read` | `readall`

**Introduced in R2018a**



# regressionLayer

Create a regression output layer

## Syntax

```
layer = regressionLayer
layer = regressionLayer(Name,Value)
```

## Description

A regression layer computes the half-mean-squared-error loss for regression problems.

`layer = regressionLayer` returns a regression output layer for a neural network as a `RegressionOutputLayer` object.

Predict responses of a trained regression network using `predict`. Normalizing the responses often helps stabilizing and speeding up training of neural networks for regression. For more information, see “Train Convolutional Neural Network for Regression”.

`layer = regressionLayer(Name,Value)` sets the optional `Name` and `ResponseNames` properties using name-value pairs. For example, `regressionLayer('Name','output')` creates a regression layer with the name 'output'. Enclose each property name in single quotes.

## Examples

### Create Regression Output Layer

Create a regression output layer with the name 'rouput'.

```
layer = regressionLayer('Name','rouput')
```

```
layer =
  RegressionOutputLayer with properties:
        Name: 'rouput'
  ResponseNames: {}

  Hyperparameters
    LossFunction: 'mean-squared-error'
```

The default loss function for regression is mean-squared-error.

Include a regression output layer in a Layer array.

```
layers = [ ...
  imageInputLayer([28 28 1])
  convolution2dLayer(12,25)
  reluLayer
  fullyConnectedLayer(1)
  regressionLayer]
```

```
layers =  
    5x1 Layer array with layers:  
  
    1 '' Image Input      28x28x1 images with 'zerocenter' normalization  
    2 '' Convolution     25 12x12 convolutions with stride [1 1] and padding [0 0 0  
    3 '' ReLU            ReLU  
    4 '' Fully Connected 1 fully connected layer  
    5 '' Regression Output mean-squared-error
```

## Input Arguments

### Name-Value Pair Arguments

Specify optional comma-separated pairs of **Name**, **Value** arguments. **Name** is the argument name and **Value** is the corresponding value. **Name** must appear inside quotes. You can specify several name and value pair arguments in any order as **Name1**, **Value1**, ..., **NameN**, **ValueN**.

Example: `regressionLayer('Name', 'output')` creates a regression layer with the name 'output'

#### **Name — Layer name**

'' (default) | character vector | string scalar

Layer name, specified as a character vector or a string scalar. To include a layer in a layer graph, you must specify a nonempty unique layer name. If you train a series network with the layer and **Name** is set to '', then the software automatically assigns a name to the layer at training time.

Data Types: `char` | `string`

#### **ResponseNames — Names of responses**

{ } (default) | cell array of character vectors | string array

Names of the responses, specified a cell array of character vectors or a string array. At training time, the software automatically sets the response names according to the training data. The default is { }.

Data Types: `cell`

## Output Arguments

### **layer — Regression output layer**

`RegressionOutputLayer` object

Regression output layer, returned as a `RegressionOutputLayer` object.

## More About

### **Regression Output Layer**

A regression layer computes the half-mean-squared-error loss for regression problems. For typical regression problems, a regression layer must follow the final fully connected layer.

For a single observation, the mean-squared-error is given by:

$$\text{MSE} = \sum_{i=1}^R \frac{(t_i - y_i)^2}{R},$$

where  $R$  is the number of responses,  $t_i$  is the target output, and  $y_i$  is the network's prediction for response  $i$ .

For image and sequence-to-one regression networks, the loss function of the regression layer is the half-mean-squared-error of the predicted responses, not normalized by  $R$ :

$$\text{loss} = \frac{1}{2} \sum_{i=1}^R (t_i - y_i)^2.$$

For image-to-image regression networks, the loss function of the regression layer is the half-mean-squared-error of the predicted responses for each pixel, not normalized by  $R$ :

$$\text{loss} = \frac{1}{2} \sum_{p=1}^{HWC} (t_p - y_p)^2,$$

where  $H$ ,  $W$ , and  $C$  denote the height, width, and number of channels of the output respectively, and  $p$  indexes into each element (pixel) of  $t$  and  $y$  linearly.

For sequence-to-sequence regression networks, the loss function of the regression layer is the half-mean-squared-error of the predicted responses for each time step, not normalized by  $R$ :

$$\text{loss} = \frac{1}{2S} \sum_{i=1}^S \sum_{j=1}^R (t_{ij} - y_{ij})^2,$$

where  $S$  is the sequence length.

When training, the software calculates the mean loss over the observations in the mini-batch.

## Extended Capabilities

### GPU Code Generation

Generate CUDA® code for NVIDIA® GPUs using GPU Coder™.

### See Also

`RegressionOutputLayer` | `classificationLayer` | `fullyConnectedLayer`

### Topics

"Deep Learning in MATLAB"

"Train Convolutional Neural Network for Regression"

**Introduced in R2017a**

# RegressionOutputLayer

Regression output layer

## Description

A regression layer computes the half-mean-squared-error loss for regression problems.

## Creation

Create a regression output layer using `regressionLayer`.

## Properties

### Regression Output

#### ResponseNames — Names of responses

`{}` (default) | cell array of character vectors | string array

Names of the responses, specified a cell array of character vectors or a string array. At training time, the software automatically sets the response names according to the training data. The default is `{}`.

Data Types: `cell`

#### LossFunction — Loss function for training

`'mean-squared-error'`

Loss function the software uses for training, specified as `'mean-squared-error'`.

### Layer

#### Name — Layer name

`''` (default) | character vector | string scalar

Layer name, specified as a character vector or a string scalar. To include a layer in a layer graph, you must specify a nonempty unique layer name. If you train a series network with the layer and `Name` is set to `''`, then the software automatically assigns a name to the layer at training time.

Data Types: `char` | `string`

#### NumInputs — Number of inputs

1 (default)

Number of inputs of the layer. This layer accepts a single input only.

Data Types: `double`

#### InputNames — Input names

`{'in'}` (default)

Input names of the layer. This layer accepts a single input only.

Data Types: cell

### NumOutputs — Number of outputs

0 (default)

Number of outputs of the layer. The layer has no outputs.

Data Types: double

### OutputNames — Output names

{ } (default)

Output names of the layer. The layer has no outputs.

Data Types: cell

## Examples

### Create Regression Output Layer

Create a regression output layer with the name 'rouput'.

```
layer = regressionLayer('Name','rouput')
```

```
layer =
  RegressionOutputLayer with properties:
      Name: 'rouput'
      ResponseNames: {}

  Hyperparameters
      LossFunction: 'mean-squared-error'
```

The default loss function for regression is mean-squared-error.

Include a regression output layer in a Layer array.

```
layers = [ ...
  imageInputLayer([28 28 1])
  convolution2dLayer(12,25)
  reluLayer
  fullyConnectedLayer(1)
  regressionLayer]

layers =
  5x1 Layer array with layers:

   1  ''  Image Input           28x28x1 images with 'zerocenter' normalization
   2  ''  Convolution           25 12x12 convolutions with stride [1 1] and padding [0 0 0]
   3  ''  ReLU                  ReLU
   4  ''  Fully Connected       1 fully connected layer
   5  ''  Regression Output     mean-squared-error
```

## More About

### Regression Output Layer

A regression layer computes the half-mean-squared-error loss for regression problems. For typical regression problems, a regression layer must follow the final fully connected layer.

For a single observation, the mean-squared-error is given by:

$$\text{MSE} = \sum_{i=1}^R \frac{(t_i - y_i)^2}{R},$$

where  $R$  is the number of responses,  $t_i$  is the target output, and  $y_i$  is the network's prediction for response  $i$ .

For image and sequence-to-one regression networks, the loss function of the regression layer is the half-mean-squared-error of the predicted responses, not normalized by  $R$ :

$$\text{loss} = \frac{1}{2} \sum_{i=1}^R (t_i - y_i)^2.$$

For image-to-image regression networks, the loss function of the regression layer is the half-mean-squared-error of the predicted responses for each pixel, not normalized by  $R$ :

$$\text{loss} = \frac{1}{2} \sum_{p=1}^{HWC} (t_p - y_p)^2,$$

where  $H$ ,  $W$ , and  $C$  denote the height, width, and number of channels of the output respectively, and  $p$  indexes into each element (pixel) of  $t$  and  $y$  linearly.

For sequence-to-sequence regression networks, the loss function of the regression layer is the half-mean-squared-error of the predicted responses for each time step, not normalized by  $R$ :

$$\text{loss} = \frac{1}{2S} \sum_{i=1}^S \sum_{j=1}^R (t_{ij} - y_{ij})^2,$$

where  $S$  is the sequence length.

When training, the software calculates the mean loss over the observations in the mini-batch.

### See Also

`classificationLayer` | `fullyConnectedLayer` | `regressionLayer` | `trainNetwork`

### Topics

“Create Simple Deep Learning Network for Classification”

“Train Convolutional Neural Network for Regression”

“Deep Learning in MATLAB”

“Specify Layers of Convolutional Neural Network”  
“List of Deep Learning Layers”

**Introduced in R2017a**

## resetState

Reset the state of a recurrent neural network

### Syntax

```
updatedNet = resetState(recNet)
```

### Description

`updatedNet = resetState(recNet)` resets the state of a recurrent neural network (for example, an LSTM network) to the initial state.

### Examples

#### Reset Network State

Reset the network state between sequence predictions.

Load `JapaneseVowelsNet`, a pretrained long short-term memory (LSTM) network trained on the Japanese Vowels data set as described in [1] and [2]. This network was trained on the sequences sorted by sequence length with a mini-batch size of 27.

```
load JapaneseVowelsNet
```

View the network architecture.

```
net.Layers
```

```
ans =  
    5x1 Layer array with layers:  
  
    1 'sequenceinput' Sequence Input Sequence input with 12 dimensions  
    2 'lstm' LSTM LSTM with 100 hidden units  
    3 'fc' Fully Connected 9 fully connected layer  
    4 'softmax' Softmax softmax  
    5 'classoutput' Classification Output crossentropyex with '1' and 8 other classes
```

Load the test data.

```
[XTest,YTest] = japaneseVowelsTestData;
```

Classify a sequence and update the network state. For reproducibility, set `rng` to `'shuffle'`.

```
rng('shuffle')  
X = XTest{94};  
[net,label] = classifyAndUpdateState(net,X);  
label  
  
label = categorical  
    3
```



Classify another sequence using the updated network.

```
X = XTest{1};
label = classify(net,X)

label = categorical
      7
```

Compare the final prediction with the true label.

```
trueLabel = YTest(1)

trueLabel = categorical
          1
```

The updated state of the network may have negatively influenced the classification. Reset the network state and predict on the sequence again.

```
net = resetState(net);
label = classify(net,XTest{1})

label = categorical
      1
```

## Input Arguments

### recNet — Trained recurrent neural network

SeriesNetwork object | DAGNetwork object

Trained recurrent neural network, specified as a `SeriesNetwork` or a `DAGNetwork` object. You can get a trained network by importing a pretrained network or by training your own network using the `trainNetwork` function.

`recNet` is a recurrent neural network. It must have at least one recurrent layer (for example, an LSTM network). If the input network is not a recurrent network, then the function has no effect and returns the input network.

## Output Arguments

### updatedNet — Updated network

SeriesNetwork object | DAGNetwork object

Updated network. `updatedNet` is the same type of network as the input network.

If the input network is not a recurrent network, then the function has no effect and returns the input network.

## References

- [1] M. Kudo, J. Toyama, and M. Shimbo. "Multidimensional Curve Classification Using Passing-Through Regions." *Pattern Recognition Letters*. Vol. 20, No. 11-13, pages 1103-1111.

[2] *UCI Machine Learning Repository: Japanese Vowels Dataset*. <https://archive.ics.uci.edu/ml/datasets/Japanese+Vowels>

## Extended Capabilities

### GPU Code Generation

Generate CUDA® code for NVIDIA® GPUs using GPU Coder™.

Usage notes and limitations:

- GPU code generation for the `resetState` function is only supported for recurrent neural networks and cuDNN target library.

### See Also

`biLstmLayer` | `classifyAndUpdateState` | `gruLayer` | `lstmLayer` | `predictAndUpdateState` | `sequenceInputLayer`

### Topics

“Sequence Classification Using Deep Learning”

“Visualize Activations of LSTM Network”

“Long Short-Term Memory Networks”

“Specify Layers of Convolutional Neural Network”

“Set Up Parameters and Train Convolutional Neural Network”

“Deep Learning in MATLAB”

### Introduced in R2017b

# rmspropupdate

Update parameters using root mean squared propagation (RMSProp)

## Syntax

```
[dlnet, averageSqGrad] = rmspropupdate(dlnet, grad, averageSqGrad)
[params, averageSqGrad] = rmspropupdate(params, grad, averageSqGrad)
[ ___ ] = rmspropupdate( ___ learnRate, sqGradDecay, epsilon)
```

## Description

Update the network learnable parameters in a custom training loop using the root mean squared propagation (RMSProp) algorithm.

---

**Note** This function applies the RMSProp optimization algorithm to update network parameters in custom training loops that use networks defined as `dlnetwork` objects or model functions. If you want to train a network defined as a `Layer` array or as a `LayerGraph`, use the following functions:

- Create a `TrainingOptionsRMSProp` object using the `trainingOptions` function.
  - Use the `TrainingOptionsRMSProp` object with the `trainNetwork` function.
- 

`[dlnet, averageSqGrad] = rmspropupdate(dlnet, grad, averageSqGrad)` updates the learnable parameters of the network `dlnet` using the RMSProp algorithm. Use this syntax in a training loop to iteratively update a network defined as a `dlnetwork` object.

`[params, averageSqGrad] = rmspropupdate(params, grad, averageSqGrad)` updates the learnable parameters in `params` using the RMSProp algorithm. Use this syntax in a training loop to iteratively update the learnable parameters of a network defined using functions.

`[ ___ ] = rmspropupdate( ___ learnRate, sqGradDecay, epsilon)` also specifies values to use for the global learning rate, square gradient decay, and small constant `epsilon`, in addition to the input arguments in previous syntaxes.

## Examples

### Update Learnable Parameters Using rmspropupdate

Perform a single root mean squared propagation update step with a global learning rate of `0.05` and squared gradient decay factor of `0.95`.

Create the parameters and parameter gradients as numeric arrays.

```
params = rand(3,3,4);
grad = ones(3,3,4);
```

Initialize the average squared gradient for the first iteration.

```
averageSqGrad = [];
```

Specify custom values for the global learning rate and squared gradient decay factor.

```
learnRate = 0.05;  
sqGradDecay = 0.95;
```

Update the learnable parameters using `rmspropupdate`.

```
[params,averageSqGrad] = rmspropupdate(params,grad,averageSqGrad,learnRate,sqGradDecay);
```

### **Train a Network Using `rmspropupdate`**

Use `rmspropupdate` to train a network using the root mean squared propagation (RMSProp) algorithm.

#### **Load Training Data**

Load the digits training data.

```
[XTrain,YTrain] = digitTrain4DArrayData;  
classes = categories(YTrain);  
numClasses = numel(classes);
```

#### **Define the Network**

Define the network architecture and specify the average image value using the 'Mean' option in the image input layer.

```
layers = [  
    imageInputLayer([28 28 1], 'Name', 'input', 'Mean', mean(XTrain,4))  
    convolution2dLayer(5,20, 'Name', 'conv1')  
    reluLayer('Name', 'relu1')  
    convolution2dLayer(3,20, 'Padding', 1, 'Name', 'conv2')  
    reluLayer('Name', 'relu2')  
    convolution2dLayer(3,20, 'Padding', 1, 'Name', 'conv3')  
    reluLayer('Name', 'relu3')  
    fullyConnectedLayer(numClasses, 'Name', 'fc')];  
lgraph = layerGraph(layers);
```

Create a `dlnetwork` object from the layer graph.

```
dlnet = dlnetwork(lgraph);
```

#### **Define Model Gradients Function**

Create the helper function `modelGradients`, listed at the end of the example. The function takes a `dlnetwork` object `dlnet` and a mini-batch of input data `dLX` with corresponding labels `Y`, and returns the loss and the gradients of the loss with respect to the learnable parameters in `dlnet`.

#### **Specify Training Options**

Specify the options to use during training.

```
miniBatchSize = 128;  
numEpochs = 20;  
numObservations = numel(YTrain);  
numIterationsPerEpoch = floor(numObservations./miniBatchSize);
```

Train on a GPU, if one is available. Using a GPU requires Parallel Computing Toolbox™ and a CUDA® enabled NVIDIA® GPU with compute capability 3.0 or higher.

```
executionEnvironment = "auto";
```

Initialize the squared average gradients.

```
averageSqGrad = [];
```

Initialize the training progress plot.

```
plots = "training-progress";
if plots == "training-progress"
    iteration = 1;
    figure
    lineLossTrain = animatedline;
    xlabel("Total Iterations")
    ylabel("Loss")
end
```

### Train Network

Train the model using a custom training loop. For each epoch, shuffle the data and loop over mini-batches of data. Update the network parameters using the `rmspropupdate` function. At the end of each epoch, display the training progress.

```
for epoch = 1:numEpochs
    % Shuffle data.
    idx = randperm(numel(YTrain));
    XTrain = XTrain(:,:, :, idx);
    YTrain = YTrain(idx);

    for i = 1:numIterationsPerEpoch

        % Read mini-batch of data and convert the labels to dummy
        % variables.
        idx = (i-1)*miniBatchSize+1:i*miniBatchSize;
        X = XTrain(:,:, :, idx);

        Y = zeros(numClasses, miniBatchSize, 'single');
        for c = 1:numClasses
            Y(c,YTrain(idx)==classes(c)) = 1;
        end

        % Convert mini-batch of data to a darray.
        dlX = darray(single(X), 'SSCB');

        % If training on a GPU, then convert data to a gpuArray.
        if (executionEnvironment == "auto" && canUseGPU) || executionEnvironment == "gpu"
            dlX = gpuArray(dlX);
        end

        % Evaluate the model gradients and loss using dlfeval and the
        % modelGradients helper function.
        [grad,loss] = dlfeval(@modelGradients,dlnet,dlX,Y);

        % Update the network parameters using the RMSProp optimizer.
        [dlnet,averageSqGrad] = rmspropupdate(dlnet,grad,averageSqGrad);
    end
end
```

```

% Display the training progress.
if plots == "training-progress"
    addpoints(lineLossTrain,iteration,double(gather(extractdata(loss))))
    title("Loss During Training: Epoch - " + epoch + "; Iteration - " + i)
    drawnow
    iteration = iteration + 1;
end
end
end
end

```

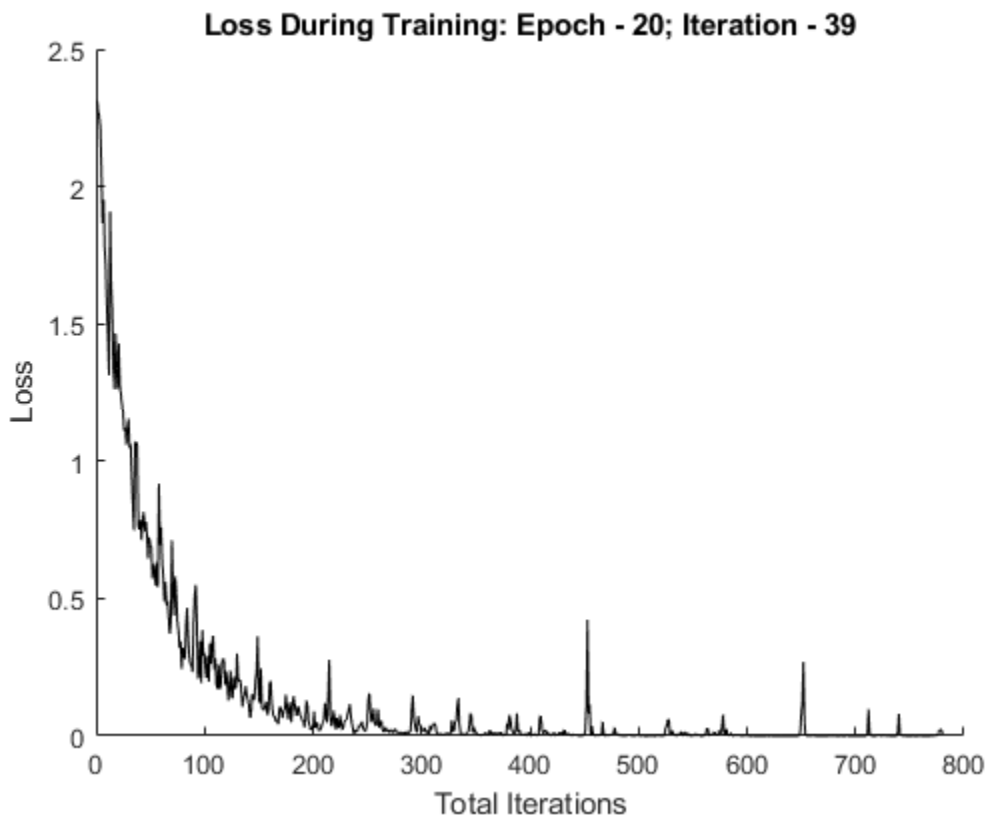

### Test the Network

Test the classification accuracy of the model by comparing the predictions on a test set with the true labels.

```
[XTest, YTest] = digitTest4DArrayData;
```

Convert the data to a `darray` with dimension format 'SSCB'. For GPU prediction, also convert the data to a `gpuArray`.

```

dLXTest = darray(XTest,'SSCB');
if (executionEnvironment == "auto" && canUseGPU) || executionEnvironment == "gpu"
    dLXTest = gpuArray(dLXTest);
end

```

To classify images using a `dlnetwork` object, use the `predict` function and find the classes with the highest scores.

```
dLYPred = predict(dlnet,dLXTest);
[~,idx] = max(extractdata(dLYPred),[],1);
YPred = classes(idx);
```

Evaluate the classification accuracy.

```
accuracy = mean(YPred==YTest)
```

```
accuracy = 0.9852
```

## Model Gradients Function

The helper function `modelGradients` takes a `dlnetwork` object `dlnet` and a mini-batch of input data `dLX` with corresponding labels `Y`, and returns the loss and the gradients of the loss with respect to the learnable parameters in `dlnet`. To compute the gradients automatically, use the `dlgradient` function.

```
function [gradients,loss] = modelGradients(dlnet,dLX,Y)
    dLYPred = forward(dlnet,dLX);
    dLYPred = softmax(dLYPred);

    loss = crossentropy(dLYPred,Y);
    gradients = dlgradient(loss,dlnet.Learnables);
end
```

## Input Arguments

### `dlnet` — Network

`dlnetwork` object

Network, specified as a `dlnetwork` object.

The function updates the `dlnet.Learnables` property of the `dlnetwork` object. `dlnet.Learnables` is a table with three variables:

- `Layer` — Layer name, specified as a string scalar.
- `Parameter` — Parameter name, specified as a string scalar.
- `Value` — Value of parameter, specified as a cell array containing a `dlarray`.

The input argument `grad` must be a table of the same form as `dlnet.Learnables`.

### `params` — Network learnable parameters

`dlarray` | numeric array | cell array | structure | table

Network learnable parameters, specified as a `dlarray`, a numeric array, a cell array, a structure, or a table.

If you specify `params` as a table, it must contain the following three variables.

- `Layer` — Layer name, specified as a string scalar.
- `Parameter` — Parameter name, specified as a string scalar.
- `Value` — Value of parameter, specified as a cell array containing a `dlarray`.

You can specify `params` as a container of learnable parameters for your network using a cell array, structure, or table, or nested cell arrays or structures. The learnable parameters inside the cell array, structure, or table must be `darray` or numeric values of data type `double` or `single`.

The input argument `grad` must be provided with exactly the same data type, ordering, and fields (for structures) or variables (for tables) as `params`.

Data Types: `single` | `double` | `struct` | `table` | `cell`

**grad — Gradients of loss**

`darray` | numeric array | cell array | structure | table

Gradients of the loss, specified as a `darray`, a numeric array, a cell array, a structure, or a table.

The exact form of `grad` depends on the input network or learnable parameters. The following table shows the required format for `grad` for possible inputs to `rmspropupdate`.

Input	Learnable Parameters	Gradients
<code>dlnet</code>	Table <code>dlnet.Learnables</code> containing <code>Layer</code> , <code>Parameter</code> , and <code>Value</code> variables. The <code>Value</code> variable consists of cell arrays that contain each learnable parameter as a <code>darray</code> .	Table with the same data type, variables, and ordering as <code>dlnet.Learnables</code> . <code>grad</code> must have a <code>Value</code> variable consisting of cell arrays that contain the gradient of each learnable parameter.
<code>params</code>	<code>darray</code>	<code>darray</code> with the same data type and ordering as <code>params</code>
	Numeric array	Numeric array with the same data type and ordering as <code>params</code>
	Cell array	Cell array with the same data types, structure, and ordering as <code>params</code>
	Structure	Structure with the same data types, fields, and ordering as <code>params</code>
	Table with <code>Layer</code> , <code>Parameter</code> , and <code>Value</code> variables. The <code>Value</code> variable must consist of cell arrays that contain each learnable parameter as a <code>darray</code> .	Table with the same data types, variables, and ordering as <code>params</code> . <code>grad</code> must have a <code>Value</code> variable consisting of cell arrays that contain the gradient of each learnable parameter.

You can obtain `grad` from a call to `dlfeval` that evaluates a function that contains a call to `dlgradient`. For more information, see “Use Automatic Differentiation In Deep Learning Toolbox”.

**averageSqGrad — Moving average of squared parameter gradients**

`[]` | `darray` | numeric array | cell array | structure | table

Moving average of squared parameter gradients, specified as an empty array, a `darray`, a numeric array, a cell array, a structure, or a table.



The exact form of `averageSqGrad` depends on the input network or learnable parameters. The following table shows the required format for `averageSqGrad` for possible inputs to `rmspropupdate`.

Input	Learnable Parameters	Average Squared Gradients
<code>dlnet</code>	Table <code>dlnet.Learnables</code> containing <code>Layer</code> , <code>Parameter</code> , and <code>Value</code> variables. The <code>Value</code> variable consists of cell arrays that contain each learnable parameter as a <code>dlarray</code> .	Table with the same data type, variables, and ordering as <code>dlnet.Learnables</code> . <code>averageSqGrad</code> must have a <code>Value</code> variable consisting of cell arrays that contain the average squared gradient of each learnable parameter.
<code>params</code>	<code>dlarray</code>	<code>dlarray</code> with the same data type and ordering as <code>params</code>
	Numeric array	Numeric array with the same data type and ordering as <code>params</code>
	Cell array	Cell array with the same data types, structure, and ordering as <code>params</code>
	Structure	Structure with the same data types, fields, and ordering as <code>params</code>
	Table with <code>Layer</code> , <code>Parameter</code> , and <code>Value</code> variables. The <code>Value</code> variable must consist of cell arrays that contain each learnable parameter as a <code>dlarray</code> .	Table with the same data types, variables, and ordering as <code>params</code> . <code>averageSqGrad</code> must have a <code>Value</code> variable consisting of cell arrays that contain the average squared gradient of each learnable parameter.

If you specify `averageSqGrad` as an empty array, the function assumes no previous gradients and runs in the same way as for the first update in a series of iterations. To update the learnable parameters iteratively, use the `averageSqGrad` output of a previous call to `rmspropupdate` as the `averageSqGrad` input.

### LearnRate — Global learning rate

0.001 (default) | positive scalar

Global learning rate, specified as a positive scalar. The default value of `LearnRate` is 0.001.

If you specify the network parameters as a `dlnetwork`, the learning rate for each parameter is the global learning rate multiplied by the corresponding learning rate factor property defined in the network layers.

### sqGradDecay — Squared gradient decay factor

0.9 (default) | positive scalar between 0 and 1.

Squared gradient decay factor, specified as a positive scalar between 0 and 1. The default value of `sqGradDecay` is 0.9.

**epsilon — Small constant**

1e-8 (default) | positive scalar

Small constant for preventing divide-by-zero errors, specified as a positive scalar. The default value of `epsilon` is 1e-8.

## Output Arguments

**dlnet — Updated network**

`dlnetwork` object

Network, returned as a `dlnetwork` object.

The function updates the `dlnet.Learnables` property of the `dlnetwork` object.

**params — Updated network learnable parameters**

`dlarray` | numeric array | cell array | structure | table

Updated network learnable parameters, returned as a `dlarray`, a numeric array, a cell array, a structure, or a table with a `Value` variable containing the updated learnable parameters of the network.

**averageSqGrad — Updated moving average of squared parameter gradients**

`dlarray` | numeric array | cell array | structure | table

Updated moving average of squared parameter gradients, returned as a `dlarray`, a numeric array, a cell array, a structure, or a table.

## More About

**RMSProp**

The function uses the root mean squared propagation algorithm to update the learnable parameters. For more information, see the definition of the RMSProp algorithm under “Stochastic Gradient Descent” on page 1-800 on the `trainingOptions` reference page.

## Compatibility Considerations

**rmspropupdate squared gradient decay factor default is 0.9**

*Behavior changed in R2020a*

Starting in R2020a, the default value of the squared gradient decay factor in `rmspropupdate` is 0.9. In previous versions, the default value was 0.999. To reproduce the previous default behavior, use one of the following syntaxes:

```
[dlnet,averageSqGrad] = rmspropupdate(dlnet,grad,averageSqGrad,0.001,0.999)
[params,averageSqGrad] = rmspropupdate(params,grad,averageSqGrad,0.001,0.999)
```

## Extended Capabilities

### GPU Arrays

Accelerate code by running on a graphics processing unit (GPU) using Parallel Computing Toolbox™.

Usage notes and limitations:

- When at least one of the following input arguments is a `gpuArray` or a `dlarray` with underlying data of type `gpuArray`, this function runs on the GPU.
  - `grad`
  - `averageSqGrad`
  - `params`

For more information, see “Run MATLAB Functions on a GPU” (Parallel Computing Toolbox).

### See Also

`adamupdate` | `dlarray` | `dlfeval` | `dlgradient` | `dlnetwork` | `dlupdate` | `forward` | `sgdmupdate`

### Topics

“Define Custom Training Loops, Loss Functions, and Networks”

“Specify Training Options in Custom Training Loop”

“Train Network Using Custom Training Loop”

### Introduced in R2019b

## relu

Apply rectified linear unit activation

### Syntax

```
dLY = relu(dlX)
```

### Description

The rectified linear unit (ReLU) activation operation performs a nonlinear threshold operation, where any input value less than zero is set to zero.

This operation is equivalent to

$$f(x) = \begin{cases} x, & x > 0 \\ 0, & x \leq 0. \end{cases}$$

---

**Note** This function applies the ReLU operation to `dLarray` data. If you want to apply ReLU activation within a `LayerGraph` object or `Layer` array, use the following layer:

- `reluLayer`
- 

`dLY = relu(dlX)` computes the ReLU activation of the input `dlX` by applying a threshold operation. All values in `dlX` that are less than zero are set to zero.

## Examples

### Apply ReLU Activation

Use the `relu` function to set negative values in the input data to zero.

Create the input data as a single observation of random values with a height and width of 12 and 32 channels.

```
height = 12;  
width = 12;  
channels = 32;  
observations = 1;
```

```
X = randn(height,width,channels,observations);  
dlX = dLarray(X, 'SSCB');
```

Compute the leaky ReLU activation.

```
dLY = relu(dlX);
```

All negative values in `dLX` are now set to 0.

## Input Arguments

### **dLX — Input data**

`dLarray`

Input data, specified as a `dLarray` with or without dimension labels.

Data Types: `single` | `double`

## Output Arguments

### **dLY — ReLU activations**

`dLarray`

ReLU activations, returned as a `dLarray`. The output `dLY` has the same underlying data type as the input `dLX`.

If the input data `dLX` is a formatted `dLarray`, `dLY` has the same dimension labels as `dLX`. If the input data is not a formatted `dLarray`, `dLY` is an unformatted `dLarray` with the same dimension order as the input data.

## Extended Capabilities

### **GPU Arrays**

Accelerate code by running on a graphics processing unit (GPU) using Parallel Computing Toolbox™.

Usage notes and limitations:

- When the input argument `dLX` is a `dLarray` with underlying data of type `gpuArray`, this function runs on the GPU.

For more information, see “Run MATLAB Functions on a GPU” (Parallel Computing Toolbox).

## See Also

`batchnorm` | `dLarray` | `dLconv` | `dLfeval` | `dLgradient` | `leakyrelu`

### **Topics**

“Define Custom Training Loops, Loss Functions, and Networks”

“Train Network Using Model Function”

**Introduced in R2019b**

# reluLayer

Rectified Linear Unit (ReLU) layer

## Description

A ReLU layer performs a threshold operation to each element of the input, where any value less than zero is set to zero.

This operation is equivalent to

$$f(x) = \begin{cases} x, & x \geq 0 \\ 0, & x < 0 \end{cases}$$

## Creation

### Syntax

```
layer = reluLayer  
layer = reluLayer('Name',Name)
```

### Description

`layer = reluLayer` creates a ReLU layer.

`layer = reluLayer('Name',Name)` creates a ReLU layer and sets the optional `Name` property using a name-value pair. For example, `reluLayer('Name','relu1')` creates a ReLU layer with the name `'relu1'`. Enclose the property name in single quotes.

## Properties

### Name — Layer name

`''` (default) | character vector | string scalar

Layer name, specified as a character vector or a string scalar. To include a layer in a layer graph, you must specify a nonempty unique layer name. If you train a series network with the layer and `Name` is set to `''`, then the software automatically assigns a name to the layer at training time.

Data Types: `char` | `string`

### NumInputs — Number of inputs

1 (default)

Number of inputs of the layer. This layer accepts a single input only.

Data Types: `double`

### InputNames — Input names

`{'in'}` (default)

Input names of the layer. This layer accepts a single input only.

Data Types: cell

### **NumOutputs — Number of outputs**

1 (default)

Number of outputs of the layer. This layer has a single output only.

Data Types: double

### **OutputNames — Output names**

{'out'} (default)

Output names of the layer. This layer has a single output only.

Data Types: cell

## **Examples**

### **Create ReLU Layer**

Create a ReLU layer with the name 'relu1'.

```
layer = reluLayer('Name','relu1')
```

```
layer =  
    ReLULayer with properties:
```

```
    Name: 'relu1'
```

Include a ReLU layer in a Layer array.

```
layers = [ ...  
    imageInputLayer([28 28 1])  
    convolution2dLayer(5,20)  
    reluLayer  
    maxPooling2dLayer(2,'Stride',2)  
    fullyConnectedLayer(10)  
    softmaxLayer  
    classificationLayer]
```

```
layers =  
    7x1 Layer array with layers:
```

1	''	Image Input	28x28x1 images with 'zerocenter' normalization
2	''	Convolution	20 5x5 convolutions with stride [1 1] and padding [0 0 0 0]
3	''	ReLU	ReLU
4	''	Max Pooling	2x2 max pooling with stride [2 2] and padding [0 0 0 0]
5	''	Fully Connected	10 fully connected layer
6	''	Softmax	softmax
7	''	Classification Output	crossentropyex

## More About

### ReLU Layer

A ReLU layer performs a threshold operation to each element of the input, where any value less than zero is set to zero.

Convolutional and batch normalization layers are usually followed by a nonlinear activation function such as a rectified linear unit (ReLU), specified by a ReLU layer. A ReLU layer performs a threshold operation to each element, where any input value less than zero is set to zero, that is,

$$f(x) = \begin{cases} x, & x \geq 0 \\ 0, & x < 0 \end{cases}$$

The ReLU layer does not change the size of its input.

There are other nonlinear activation layers that perform different operations and can improve the network accuracy for some applications. For a list of activation layers, see “Activation Layers”.

## References

- [1] Nair, Vinod, and Geoffrey E. Hinton. "Rectified linear units improve restricted boltzmann machines." In *Proceedings of the 27th international conference on machine learning (ICML-10)*, pp. 807-814. 2010.

## Extended Capabilities

### GPU Code Generation

Generate CUDA® code for NVIDIA® GPUs using GPU Coder™.

## See Also

**Deep Network Designer** | `batchNormalizationLayer` | `clippedReluLayer` | `leakyReluLayer` | `trainNetwork`

### Topics

“Create Simple Deep Learning Network for Classification”  
“Train Convolutional Neural Network for Regression”  
“Deep Learning in MATLAB”  
“Specify Layers of Convolutional Neural Network”  
“List of Deep Learning Layers”

### Introduced in R2016a



# removeLayers

Remove layers from layer graph

## Syntax

```
newLgraph = removeLayers(lgraph, layerNames)
```

## Description

`newLgraph = removeLayers(lgraph, layerNames)` removes the layers specified by `layerNames` from the layer graph `lgraph`. The function also removes any connections to the removed layers.

## Examples

### Remove Layer from Layer Graph

Create a layer graph from an array of layers.

```
layers = [  
    imageInputLayer([28 28 1], 'Name', 'input')  
    convolution2dLayer(3,16, 'Padding', 'same', 'Name', 'conv_1')  
    batchNormalizationLayer('Name', 'BN_1')  
    reluLayer('Name', 'relu_1')];  
  
lgraph = layerGraph(layers);  
figure  
plot(lgraph)
```

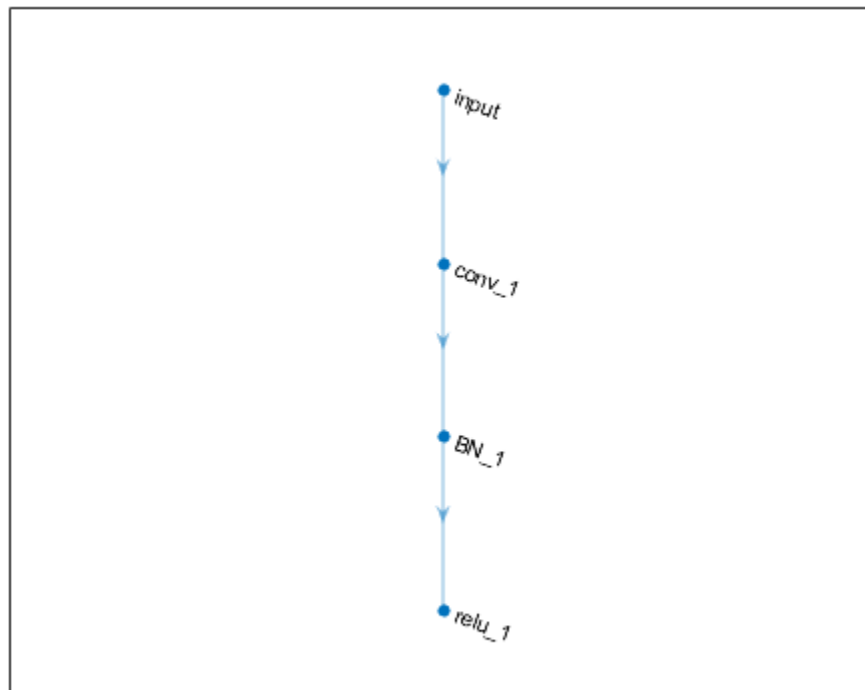

Remove the 'BN\_1' layer and its connections.

```
lgraph = removeLayers(lgraph, 'BN_1');  
figure  
plot(lgraph)
```

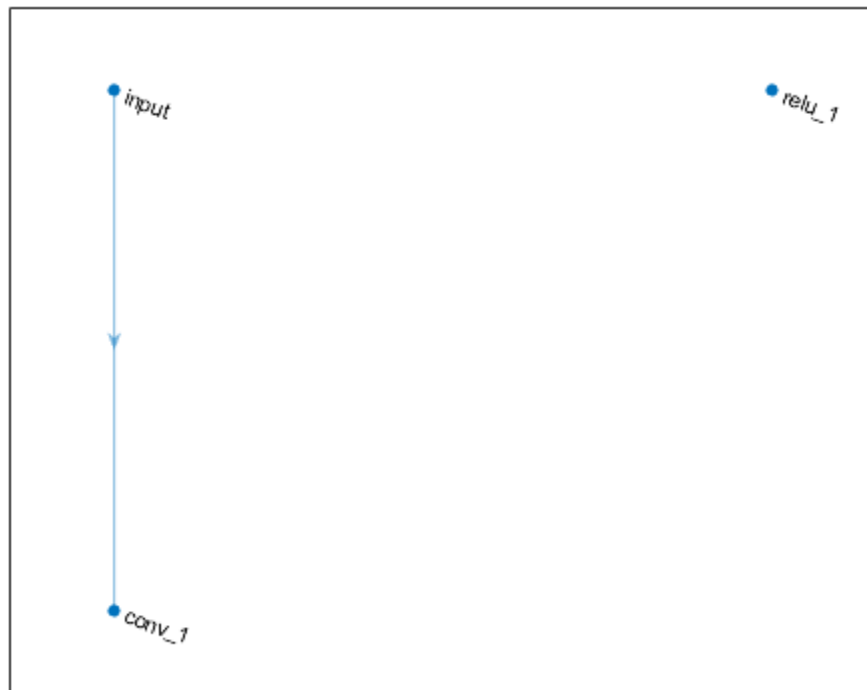

## Input Arguments

### **lgraph** — Layer graph

LayerGraph object

Layer graph, specified as a LayerGraph object. To create a layer graph, use `layerGraph`.

### **layerNames** — Names of layers to remove

character vector | cell array of character vectors | string array

Names of layers to remove, specified as a character vector, a cell array of character vectors, or a string array.

To remove a single layer from the layer graph, specify the name of the layer.

To remove multiple layers, specify the layer names in an array, where each element of the array is a layer name.

Example: `'conv1'`

Example: `{'conv1', 'add1'}`

## Output Arguments

### **newLgraph** — Output layer graph

LayerGraph object

Output layer graph, returned as a LayerGraph object.

## See Also

[addLayers](#) | [assembleNetwork](#) | [connectLayers](#) | [disconnectLayers](#) | [layerGraph](#) | [plot](#) | [replaceLayer](#)

## Topics

[“Train Residual Network for Image Classification”](#)

[“Train Deep Learning Network to Classify New Images”](#)

**Introduced in R2017b**

# replaceLayer

Replace layer in layer graph

## Syntax

```
newlgraph = replaceLayer(lgraph,layerName,larray)
newlgraph = replaceLayer(lgraph,layerName,larray,'ReconnectBy',mode)
```

## Description

`newlgraph = replaceLayer(lgraph,layerName,larray)` replaces the layer `layerName` in the layer graph `lgraph` with the layers in `larray`.

`replaceLayer` connects the layers in `larray` sequentially and connects `larray` into the layer graph.

`newlgraph = replaceLayer(lgraph,layerName,larray,'ReconnectBy',mode)` additionally specifies the method of reconnecting layers.

## Examples

### Replace Layer in Layer Graph

Define a simple network architecture and plot it.

```
layers = [
    imageInputLayer([28 28 1], 'Name', 'input')
    convolution2dLayer(3,16, 'Padding', 'same', 'Name', 'conv_1')
    reluLayer('Name', 'relu_1')
    additionLayer(2, 'Name', 'add')
    fullyConnectedLayer(10, 'Name', 'fc')
    softmaxLayer('Name', 'softmax')
    classificationLayer('Name', 'classoutput')];

lgraph = layerGraph(layers);
lgraph = connectLayers(lgraph, 'input', 'add/in2');

figure
plot(lgraph)
```

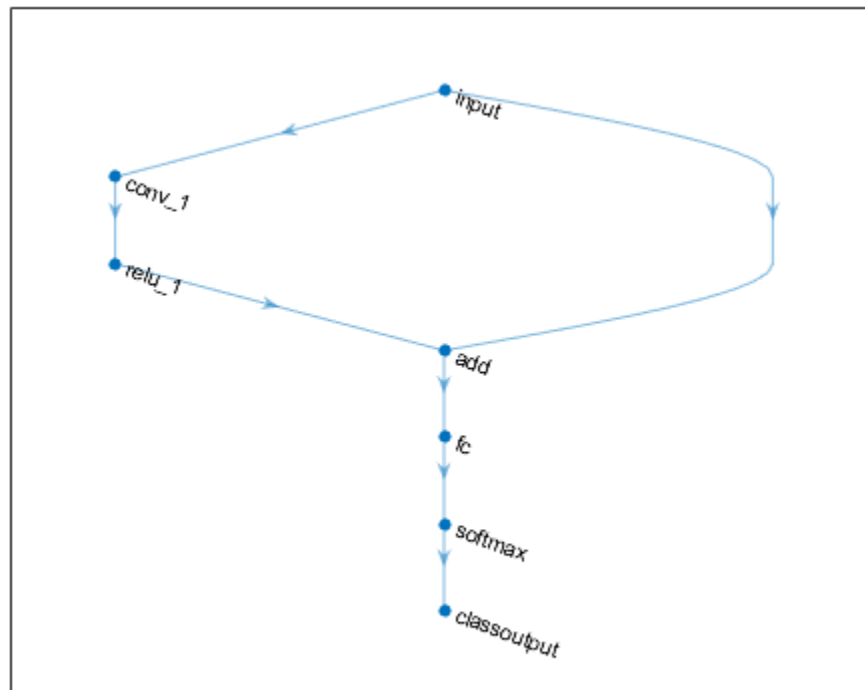

Replace the ReLU layer in the network with a batch normalization layer followed by a leaky ReLU layer.

```

larray = [batchNormalizationLayer('Name','BN1')
          leakyReluLayer('Name','leakyRelu_1','Scale',0.1)];
lgraph = replaceLayer(lgraph,'relu_1',larray);

plot(lgraph)
  
```

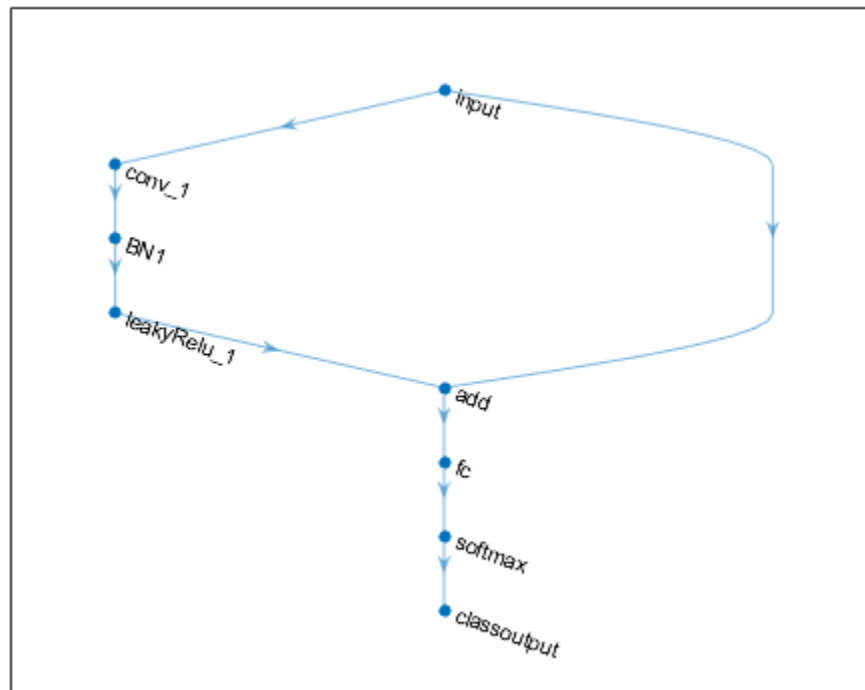

### Assemble Network from Pretrained Keras Layers

This example shows how to import the layers from a pretrained Keras network, replace the unsupported layers with custom layers, and assemble the layers into a network ready for prediction.

#### Import Keras Network

Import the layers from a Keras network model. The network in 'digitsDAGnetwithnoise.h5' classifies images of digits.

```
filename = 'digitsDAGnetwithnoise.h5';
lgraph = importKerasLayers(filename, 'ImportWeights', true);
```

Warning: Unable to import some Keras layers, because they are not yet supported by the Deep Learning Toolbox.

The Keras network contains some layers that are not supported by Deep Learning Toolbox. The `importKerasLayers` function displays a warning and replaces the unsupported layers with placeholder layers.

Plot the layer graph using `plot`.

```
figure
plot(lgraph)
title("Imported Network")
```

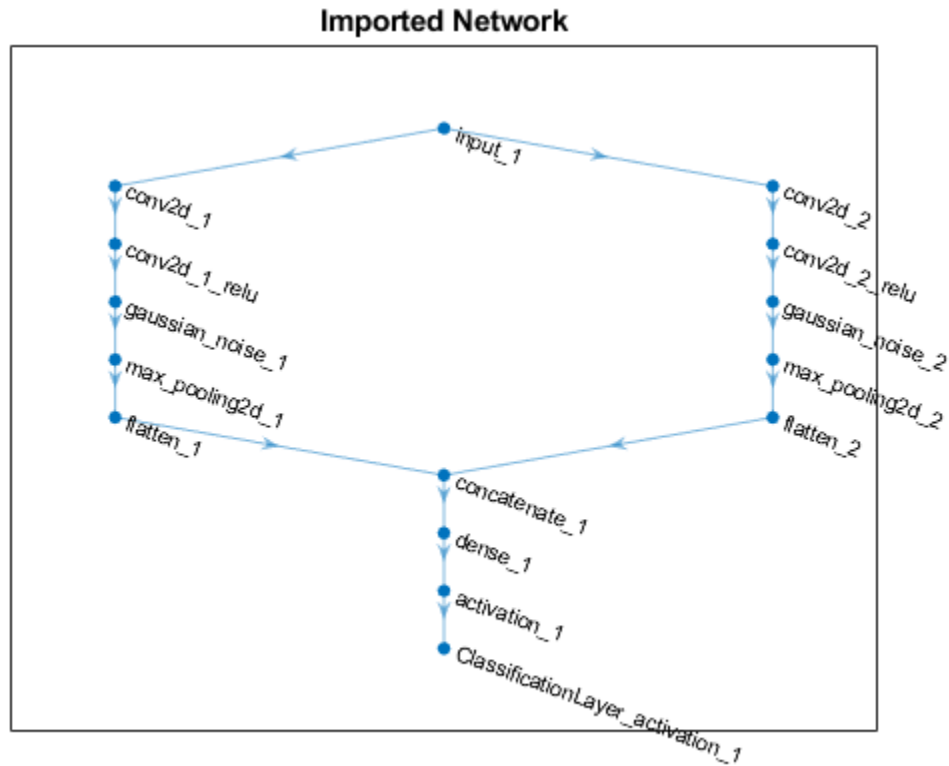

### Replace Placeholder Layers

To replace the placeholder layers, first identify the names of the layers to replace. Find the placeholder layers using `findPlaceholderLayers`.

```
placeholderLayers = findPlaceholderLayers(lgraph)
```

```
placeholderLayers =
  2x1 PlaceholderLayer array with layers:
```

1	'gaussian_noise_1'	PLACEHOLDER LAYER	Placeholder for 'GaussianNoise' Keras layer
2	'gaussian_noise_2'	PLACEHOLDER LAYER	Placeholder for 'GaussianNoise' Keras layer

Display the Keras configurations of these layers.

```
placeholderLayers.KerasConfiguration
```

```
ans = struct with fields:
  trainable: 1
  name: 'gaussian_noise_1'
  stddev: 1.5000
```

```
ans = struct with fields:
  trainable: 1
  name: 'gaussian_noise_2'
  stddev: 0.7000
```



Define a custom Gaussian noise layer. To create this layer, save the file `gaussianNoiseLayer.m` in the current folder. Then, create two Gaussian noise layers with the same configurations as the imported Keras layers.

```
gnLayer1 = gaussianNoiseLayer(1.5, 'new_gaussian_noise_1');
gnLayer2 = gaussianNoiseLayer(0.7, 'new_gaussian_noise_2');
```

Replace the placeholder layers with the custom layers using `replaceLayer`.

```
lgraph = replaceLayer(lgraph, 'gaussian_noise_1', gnLayer1);
lgraph = replaceLayer(lgraph, 'gaussian_noise_2', gnLayer2);
```

Plot the updated layer graph using `plot`.

```
figure
plot(lgraph)
title("Network with Replaced Layers")
```

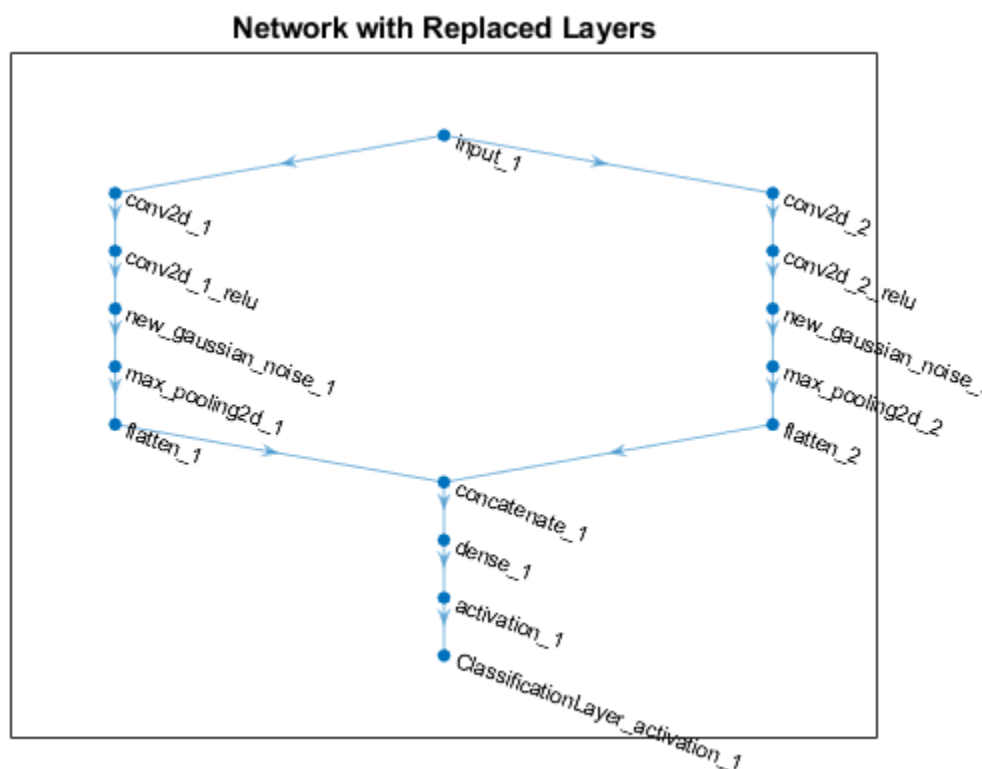

### Specify Class Names

If the imported classification layer does not contain the classes, then you must specify these before prediction. If you do not specify the classes, then the software automatically sets the classes to 1, 2, ..., N, where N is the number of classes.

Find the index of the classification layer by viewing the `Layers` property of the layer graph.

```
lgraph.Layers
```

```
ans =
  15x1 Layer array with layers:

    1  'input_1'           Image Input           28x28x1 images
    2  'conv2d_1'         Convolution           20 7x7x1 convolutions with
    3  'conv2d_1_relu'    ReLU                 ReLU
    4  'conv2d_2'         Convolution           20 3x3x1 convolutions with
    5  'conv2d_2_relu'    ReLU                 ReLU
    6  'new_gaussian_noise_1' Gaussian Noise        Gaussian noise with standar
    7  'new_gaussian_noise_2' Gaussian Noise        Gaussian noise with standar
    8  'max_pooling2d_1'  Max Pooling          2x2 max pooling with strid
    9  'max_pooling2d_2'  Max Pooling          2x2 max pooling with strid
   10  'flatten_1'       Keras Flatten        Flatten activations into 1
   11  'flatten_2'       Keras Flatten        Flatten activations into 1
   12  'concatenate_1'   Depth concatenation   Depth concatenation of 2 in
   13  'dense_1'         Fully Connected      10 fully connected layer
   14  'activation_1'    Softmax              softmax
   15  'ClassificationLayer_activation_1' Classification Output crossentropyex
```

The classification layer has the name 'ClassificationLayer\_activation\_1'. View the classification layer and check the Classes property.

```
cLayer = lgraph.Layers(end)
```

```
cLayer =
  ClassificationOutputLayer with properties:

    Name: 'ClassificationLayer_activation_1'
    Classes: 'auto'
    OutputSize: 'auto'

    Hyperparameters
    LossFunction: 'crossentropyex'
```

Because the Classes property of the layer is 'auto', you must specify the classes manually. Set the classes to 0, 1, ..., 9, and then replace the imported classification layer with the new one.

```
cLayer.Classes = string(0:9)
```

```
cLayer =
  ClassificationOutputLayer with properties:

    Name: 'ClassificationLayer_activation_1'
    Classes: [0 1 2 3 4 5 6 7 8 9]
    OutputSize: 10

    Hyperparameters
    LossFunction: 'crossentropyex'
```

```
lgraph = replaceLayer(lgraph, 'ClassificationLayer_activation_1', cLayer);
```

### Assemble Network

Assemble the layer graph using assembleNetwork. The function returns a DAGNetwork object that is ready to use for prediction.

```
net = assembleNetwork(lgraph)
```

```
net =
  DAGNetwork with properties:

      Layers: [15x1 nnet.cnn.layer.Layer]
  Connections: [15x2 table]
  InputNames: {'input_1'}
  OutputNames: {'ClassificationLayer_activation_1'}
```

## Input Arguments

### **lgraph** — Layer graph

LayerGraph object

Layer graph, specified as a LayerGraph object. To create a layer graph, use `layerGraph`.

### **layerName** — Name of layer to replace

string scalar | character vector

Name of the layer to replace, specified as a string scalar or a character vector.

### **larray** — Network layers

Layer array

Network layers, specified as a Layer array.

For a list of built-in layers, see “List of Deep Learning Layers”.

### **mode** — Method to reconnect layers

'name' (default) | 'order'

Method to reconnect layers specified as one of the following:

- 'name' - Reconnect `larray` using the input and output names of the replaced layer. For each layer connected to an input of the replaced layer, reconnect the layer to the input of the same input name of `larray(1)`. For each layer connected to an output of the replaced layer, reconnect the layer to the output of the same output name of `larray(end)`.
- 'order' - Reconnect `larray` using the order of the input names of `larray(1)` and the output names of `larray(end)`. Reconnect the layer connected to the *i*th input of the replaced layer to the *i*th input of `larray(1)`. Reconnect the layer connected to the *j*th output of the replaced layer to the *j*th output of `larray(end)`.

Data Types: char | string

## Output Arguments

### **newlgraph** — Output layer graph

LayerGraph object

Output layer graph, returned as a LayerGraph object.

## See Also

PlaceholderLayer | addLayers | assembleNetwork | connectLayers | disconnectLayers | findPlaceholderLayers | layerGraph | removeLayers

**Topics**

“Deep Learning in MATLAB”

“Pretrained Deep Neural Networks”

“Train Residual Network for Image Classification”

“Train Deep Learning Network to Classify New Images”

**Introduced in R2018b**

# resnet18

ResNet-18 convolutional neural network

## Syntax

```
net = resnet18
net = resnet18('Weights','imagenet')

lgraph = resnet18('Weights','none')
```

## Description

ResNet-18 is a convolutional neural network that is 18 layers deep. You can load a pretrained version of the network trained on more than a million images from the ImageNet database [1]. The pretrained network can classify images into 1000 object categories, such as keyboard, mouse, pencil, and many animals. As a result, the network has learned rich feature representations for a wide range of images. The network has an image input size of 224-by-224. For more pretrained networks in MATLAB, see “Pretrained Deep Neural Networks”.

You can use `classify` to classify new images using the ResNet-18 model. Follow the steps of “Classify Image Using GoogLeNet” and replace GoogLeNet with ResNet-18.

To retrain the network on a new classification task, follow the steps of “Train Deep Learning Network to Classify New Images” and load ResNet-18 instead of GoogLeNet.

`net = resnet18` returns a ResNet-18 network trained on the ImageNet data set.

This function requires the Deep Learning Toolbox Model *for ResNet-18 Network* support package. If this support package is not installed, then the function provides a download link.

`net = resnet18('Weights','imagenet')` returns a ResNet-18 network trained on the ImageNet data set. This syntax is equivalent to `net = resnet18`.

`lgraph = resnet18('Weights','none')` returns the untrained ResNet-18 network architecture. The untrained model does not require the support package.

## Examples

### Download ResNet-18 Support Package

Download and install the Deep Learning Toolbox Model *for ResNet-18 Network* support package.

Type `resnet18` at the command line.

```
resnet18
```

If the Deep Learning Toolbox Model *for ResNet-18 Network* support package is not installed, then the function provides a link to the required support package in the Add-On Explorer. To install the support package, click the link, and then click **Install**. Check that the installation is successful by

typing `resnet18` at the command line. If the required support package is installed, then the function returns a `DAGNetwork` object.

```
resnet18
ans =
    DAGNetwork with properties:
        Layers: [72x1 nnet.cnn.layer.Layer]
        Connections: [79x2 table]
```

## Output Arguments

### **net** — Pretrained ResNet-18 convolutional neural network

`DAGNetwork` object

Pretrained ResNet-18 convolutional neural network, returned as a `DAGNetwork` object.

### **lgraph** — Untrained ResNet-18 convolutional neural network architecture

`LayerGraph` object

Untrained ResNet-18 convolutional neural network architecture, returned as a `LayerGraph` object.

## References

[1] *ImageNet*. <http://www.image-net.org>

[2] He, Kaiming, Xiangyu Zhang, Shaoqing Ren, and Jian Sun. "Deep residual learning for image recognition." In *Proceedings of the IEEE conference on computer vision and pattern recognition*, pp. 770-778. 2016.

## Extended Capabilities

### **C/C++ Code Generation**

Generate C and C++ code using MATLAB® Coder™.

For code generation, you can load the network by using the syntax `net = resnet18` or by passing the `resnet18` function to `coder.loadDeepLearningNetwork`. For example: `net = coder.loadDeepLearningNetwork('resnet18')`

For more information, see "Load Pretrained Networks for Code Generation" (MATLAB Coder).

The syntax `resnet18('Weights', 'none')` is not supported for code generation.

### **GPU Code Generation**

Generate CUDA® code for NVIDIA® GPUs using GPU Coder™.

Usage notes and limitations:

- For code generation, you can load the network by using the syntax `net = resnet18` or by passing the `resnet18` function to `coder.loadDeepLearningNetwork`. For example: `net = coder.loadDeepLearningNetwork('resnet18')`

For more information, see “Load Pretrained Networks for Code Generation” (GPU Coder).

- The syntax `resnet18('Weights', 'none')` is not supported for GPU code generation.

## See Also

[DAGNetwork](#) | [alexnet](#) | [densenet201](#) | [googlenet](#) | [inceptionresnetv2](#) | [layerGraph](#) | [plot](#) | [resnet101](#) | [resnet50](#) | [squeezenet](#) | [trainNetwork](#) | [vgg16](#) | [vgg19](#)

## Topics

“Deep Learning in MATLAB”

“Pretrained Deep Neural Networks”

“Classify Image Using GoogLeNet”

“Train Deep Learning Network to Classify New Images”

“Train Residual Network for Image Classification”

## Introduced in R2018a

## resnet50

ResNet-50 convolutional neural network

### Syntax

```
net = resnet50
net = resnet50('Weights','imagenet')

lgraph = resnet50('Weights','none')
```

### Description

ResNet-50 is a convolutional neural network that is 50 layers deep. You can load a pretrained version of the network trained on more than a million images from the ImageNet database [1]. The pretrained network can classify images into 1000 object categories, such as keyboard, mouse, pencil, and many animals. As a result, the network has learned rich feature representations for a wide range of images. The network has an image input size of 224-by-224. For more pretrained networks in MATLAB, see “Pretrained Deep Neural Networks”.

You can use `classify` to classify new images using the ResNet-50 model. Follow the steps of “Classify Image Using GoogLeNet” and replace GoogLeNet with ResNet-50.

To retrain the network on a new classification task, follow the steps of “Train Deep Learning Network to Classify New Images” and load ResNet-50 instead of GoogLeNet.

`net = resnet50` returns a ResNet-50 network trained on the ImageNet data set.

This function requires the Deep Learning Toolbox Model *for ResNet-50 Network* support package. If this support package is not installed, then the function provides a download link.

`net = resnet50('Weights','imagenet')` returns a ResNet-50 network trained on the ImageNet data set. This syntax is equivalent to `net = resnet50`.

`lgraph = resnet50('Weights','none')` returns the untrained ResNet-50 network architecture. The untrained model does not require the support package.

### Examples

#### Download ResNet-50 Support Package

Download and install the Deep Learning Toolbox Model *for ResNet-50 Network* support package.

Type `resnet50` at the command line.

```
resnet50
```

If the Deep Learning Toolbox Model *for ResNet-50 Network* support package is not installed, then the function provides a link to the required support package in the Add-On Explorer. To install the support package, click the link, and then click **Install**. Check that the installation is successful by



typing `resnet50` at the command line. If the required support package is installed, then the function returns a `DAGNetwork` object.

```
resnet50
```

```
ans =
```

```
DAGNetwork with properties:
```

```
    Layers: [177x1 nnet.cnn.layer.Layer]
Connections: [192x2 table]
```

## Output Arguments

### **net** — Pretrained ResNet-50 convolutional neural network

`DAGNetwork` object

Pretrained ResNet-50 convolutional neural network, returned as a `DAGNetwork` object.

### **lgraph** — Untrained ResNet-50 convolutional neural network architecture

`LayerGraph` object

Untrained ResNet-50 convolutional neural network architecture, returned as a `LayerGraph` object.

## References

[1] *ImageNet*. <http://www.image-net.org>

[2] He, Kaiming, Xiangyu Zhang, Shaoqing Ren, and Jian Sun. "Deep residual learning for image recognition." In *Proceedings of the IEEE conference on computer vision and pattern recognition*, pp. 770-778. 2016.

[3] <https://keras.io/applications/#resnet50>

## Extended Capabilities

### **C/C++ Code Generation**

Generate C and C++ code using MATLAB® Coder™.

For code generation, you can load the network by using the syntax `net = resnet50` or by passing the `resnet50` function to `coder.loadDeepLearningNetwork`. For example: `net = coder.loadDeepLearningNetwork('resnet50')`

For more information, see "Load Pretrained Networks for Code Generation" (MATLAB Coder).

The syntax `resnet50('Weights','none')` is not supported for code generation.

### **GPU Code Generation**

Generate CUDA® code for NVIDIA® GPUs using GPU Coder™.

Usage notes and limitations:

- For code generation, you can load the network by using the syntax `net = resnet50` or by passing the `resnet50` function to `coder.loadDeepLearningNetwork`. For example: `net = coder.loadDeepLearningNetwork('resnet50')`

For more information, see “Load Pretrained Networks for Code Generation” (GPU Coder).

- The syntax `resnet50('Weights','none')` is not supported for GPU code generation.

## See Also

[DAGNetwork](#) | [alexnet](#) | [densenet201](#) | [googlenet](#) | [inceptionresnetv2](#) | [layerGraph](#) | [plot](#) | [resnet101](#) | [resnet18](#) | [squeezeNet](#) | [trainNetwork](#) | [vgg16](#) | [vgg19](#)

## Topics

“Deep Learning in MATLAB”

“Pretrained Deep Neural Networks”

“Classify Image Using GoogLeNet”

“Train Deep Learning Network to Classify New Images”

“Train Residual Network for Image Classification”

## Introduced in R2017b

# resnet101

ResNet-101 convolutional neural network

## Syntax

```
net = resnet101
net = resnet101('Weights','imagenet')

lgraph = resnet101('Weights','none')
```

## Description

ResNet-101 is a convolutional neural network that is 101 layers deep. You can load a pretrained version of the network trained on more than a million images from the ImageNet database [1]. The pretrained network can classify images into 1000 object categories, such as keyboard, mouse, pencil, and many animals. As a result, the network has learned rich feature representations for a wide range of images. The network has an image input size of 224-by-224. For more pretrained networks in MATLAB, see “Pretrained Deep Neural Networks”.

You can use `classify` to classify new images using the ResNet-101 model. Follow the steps of “Classify Image Using GoogLeNet” and replace GoogLeNet with ResNet-101.

To retrain the network on a new classification task, follow the steps of “Train Deep Learning Network to Classify New Images” and load ResNet-101 instead of GoogLeNet.

`net = resnet101` returns a ResNet-101 network trained on the ImageNet data set.

This function requires the Deep Learning Toolbox Model *for ResNet-101 Network* support package. If this support package is not installed, then the function provides a download link.

`net = resnet101('Weights','imagenet')` returns a ResNet-101 network trained on the ImageNet data set. This syntax is equivalent to `net = resnet101`.

`lgraph = resnet101('Weights','none')` returns the untrained ResNet-101 network architecture. The untrained model does not require the support package.

## Examples

### Download ResNet-101 Support Package

Download and install the Deep Learning Toolbox Model *for ResNet-101 Network* support package.

Type `resnet101` at the command line.

```
resnet101
```

If the Deep Learning Toolbox Model *for ResNet-101 Network* support package is not installed, then the function provides a link to the required support package in the Add-On Explorer. To install the support package, click the link, and then click **Install**. Check that the installation is successful by

typing `resnet101` at the command line. If the required support package is installed, then the function returns a `DAGNetwork` object.

```
resnet101
ans =
    DAGNetwork with properties:
        Layers: [347x1 nnet.cnn.layer.Layer]
        Connections: [379x2 table]
```

## Output Arguments

### **net** — Pretrained ResNet-101 convolutional neural network

`DAGNetwork` object

Pretrained ResNet-101 convolutional neural network, returned as a `DAGNetwork` object.

### **lgraph** — Untrained ResNet-101 convolutional neural network architecture

`LayerGraph` object

Untrained ResNet-101 convolutional neural network architecture, returned as a `LayerGraph` object.

## References

[1] *ImageNet*. <http://www.image-net.org>

[2] He, Kaiming, Xiangyu Zhang, Shaoqing Ren, and Jian Sun. "Deep residual learning for image recognition." In *Proceedings of the IEEE conference on computer vision and pattern recognition*, pp. 770-778. 2016.

[3] <https://github.com/KaimingHe/deep-residual-networks>

## Extended Capabilities

### **C/C++ Code Generation**

Generate C and C++ code using MATLAB® Coder™.

For code generation, you can load the network by using the syntax `net = resnet101` or by passing the `resnet101` function to `coder.loadDeepLearningNetwork`. For example: `net = coder.loadDeepLearningNetwork('resnet101')`

For more information, see "Load Pretrained Networks for Code Generation" (MATLAB Coder).

The syntax `resnet101('Weights', 'none')` is not supported for code generation.

### **GPU Code Generation**

Generate CUDA® code for NVIDIA® GPUs using GPU Coder™.

Usage notes and limitations:

- For code generation, you can load the network by using the syntax `net = resnet101` or by passing the `resnet101` function to `coder.loadDeepLearningNetwork`. For example: `net = coder.loadDeepLearningNetwork('resnet101')`

For more information, see “Load Pretrained Networks for Code Generation” (GPU Coder).

- The syntax `resnet101('Weights','none')` is not supported for GPU code generation.

## See Also

[DAGNetwork](#) | [alexnet](#) | [densenet201](#) | [googlenet](#) | [inceptionresnetv2](#) | [inceptionv3](#) | [layerGraph](#) | [plot](#) | [resnet18](#) | [resnet50](#) | [squeezeNet](#) | [trainNetwork](#) | [vgg16](#) | [vgg19](#)

## Topics

“Deep Learning in MATLAB”

“Pretrained Deep Neural Networks”

“Classify Image Using GoogLeNet”

“Train Deep Learning Network to Classify New Images”

“Train Residual Network for Image Classification”

## Introduced in R2017b

# sequenceFoldingLayer

Sequence folding layer

## Description

A sequence folding layer converts a batch of image sequences to a batch of images. Use a sequence folding layer to perform convolution operations on time steps of image sequences independently.

To use a sequence folding layer, you must connect the `miniBatchSize` output to the `miniBatchSize` input of the corresponding sequence unfolding layer. For an example, see “Create Network for Video Classification” on page 1-693.

## Creation

### Syntax

```
layer = sequenceFoldingLayer  
layer = sequenceFoldingLayer('Name',Name)
```

### Description

`layer = sequenceFoldingLayer` creates a sequence folding layer.

`layer = sequenceFoldingLayer('Name',Name)` creates a sequence folding layer and sets the optional `Name` property using a name-value pair. For example, `sequenceFoldingLayer('Name','fold1')` creates a sequence folding layer with the name 'fold1'. Enclose the property name in single quotes.

## Properties

### Name — Layer name

`''` (default) | character vector | string scalar

Layer name, specified as a character vector or a string scalar. To include a layer in a layer graph, you must specify a nonempty unique layer name. If you train a series network with the layer and `Name` is set to `''`, then the software automatically assigns a name to the layer at training time.

Data Types: `char` | `string`

### NumInputs — Number of inputs

1 (default)

Number of inputs of the layer. This layer accepts a single input only.

Data Types: `double`

### InputNames — Input names

`{'in'}` (default)

Input names of the layer. This layer accepts a single input only.

Data Types: cell

### **NumOutputs — Number of outputs**

2 (default)

Number of outputs of the layer.

The layer has two outputs:

- 'out' - Output feature map corresponding to reshaped input.
- 'miniBatchSize' - Size of the mini-batch passed into the layer. This output must be connected to the 'miniBatchSize' input of the corresponding sequence unfolding layer.

Data Types: double

### **OutputNames — Output names**

{'out', 'miniBatchSize'} (default)

Output names of the layer.

The layer has two outputs:

- 'out' - Output feature map corresponding to reshaped input.
- 'miniBatchSize' - Size of the mini-batch passed into the layer. This output must be connected to the 'miniBatchSize' input of the corresponding sequence unfolding layer.

Data Types: cell

## **Examples**

### **Create Sequence Folding Layer**

Create a sequence folding layer with name the 'fold1'.

```
layer = sequenceFoldingLayer('Name', 'fold1')
```

```
layer =
```

```
SequenceFoldingLayer with properties:
```

```
    Name: 'fold1'
  NumOutputs: 2
  OutputNames: {'out' 'miniBatchSize'}
```

### **Create Network for Video Classification**

Create a deep learning network for data containing sequences of images, such as video and medical image data.

- To input sequences of images into a network, use a sequence input layer.

- To apply convolutional operations independently to each time step, first convert the sequences of images to an array of images using a sequence folding layer.
- To restore the sequence structure after performing these operations, convert this array of images back to image sequences using a sequence unfolding layer.
- To convert images to feature vectors, use a flatten layer.

You can then input vector sequences into LSTM and BiLSTM layers.

### Define Network Architecture

Create a classification LSTM network that classifies sequences of 28-by-28 grayscale images into 10 classes.

Define the following network architecture:

- A sequence input layer with an input size of [28 28 1].
- A convolution, batch normalization, and ReLU layer block with 20 5-by-5 filters.
- An LSTM layer with 200 hidden units that outputs the last time step only.
- A fully connected layer of size 10 (the number of classes) followed by a softmax layer and a classification layer.

To perform the convolutional operations on each time step independently, include a sequence folding layer before the convolutional layers. LSTM layers expect vector sequence input. To restore the sequence structure and reshape the output of the convolutional layers to sequences of feature vectors, insert a sequence unfolding layer and a flatten layer between the convolutional layers and the LSTM layer.

```
inputSize = [28 28 1];
filterSize = 5;
numFilters = 20;
numHiddenUnits = 200;
numClasses = 10;

layers = [ ...
    sequenceInputLayer(inputSize, 'Name', 'input')

    sequenceFoldingLayer('Name', 'fold')

    convolution2dLayer(filterSize, numFilters, 'Name', 'conv')
    batchNormalizationLayer('Name', 'bn')
    reluLayer('Name', 'relu')

    sequenceUnfoldingLayer('Name', 'unfold')
    flattenLayer('Name', 'flatten')

    lstmLayer(numHiddenUnits, 'OutputMode', 'last', 'Name', 'lstm')

    fullyConnectedLayer(numClasses, 'Name', 'fc')
    softmaxLayer('Name', 'softmax')
    classificationLayer('Name', 'classification')];
```

Convert the layers to a layer graph and connect the `miniBatchSize` output of the sequence folding layer to the corresponding input of the sequence unfolding layer.



```
lgraph = layerGraph(layers);
lgraph = connectLayers(lgraph, 'fold/miniBatchSize', 'unfold/miniBatchSize');
```

View the final network architecture using the `plot` function.

```
figure
plot(lgraph)
```

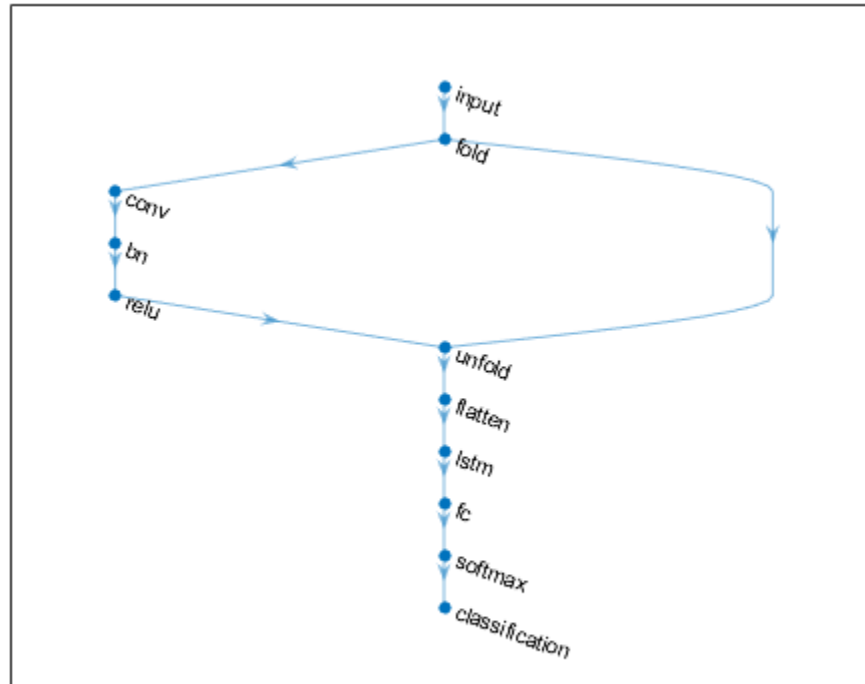

## See Also

[bilstmLayer](#) | [classifyAndUpdateState](#) | [flattenLayer](#) | [gruLayer](#) | [lstmLayer](#) | [predictAndUpdateState](#) | [resetState](#) | [sequenceInputLayer](#) | [sequenceUnfoldingLayer](#)

## Topics

[“Classify Videos Using Deep Learning”](#)  
[“Sequence Classification Using Deep Learning”](#)  
[“Time Series Forecasting Using Deep Learning”](#)  
[“Sequence-to-Sequence Classification Using Deep Learning”](#)  
[“Visualize Activations of LSTM Network”](#)  
[“Long Short-Term Memory Networks”](#)  
[“Specify Layers of Convolutional Neural Network”](#)  
[“Set Up Parameters and Train Convolutional Neural Network”](#)  
[“Deep Learning in MATLAB”](#)  
[“List of Deep Learning Layers”](#)

**Introduced in R2019a**

# sequenceInputLayer

Sequence input layer

## Description

A sequence input layer inputs sequence data to a network.

## Creation

### Syntax

```
layer = sequenceInputLayer(inputSize)
layer = sequenceInputLayer(inputSize,Name,Value)
```

### Description

`layer = sequenceInputLayer(inputSize)` creates a sequence input layer and sets the `InputSize` property.

`layer = sequenceInputLayer(inputSize,Name,Value)` sets the optional `Normalization`, `Mean`, and `Name` properties using name-value pairs. You can specify multiple name-value pairs. Enclose each property name in single quotes.

## Properties

### Image Input

#### InputSize — Size of input

positive integer | vector of positive integers

Size of the input, specified as a positive integer or a vector of positive integers.

- For vector sequence input, `InputSize` is a scalar corresponding to the number of features.
- For 2-D image sequence input, `InputSize` is vector of three elements `[h w c]`, where `h` is the image height, `w` is the image width, and `c` is the number of channels of the image.
- For 3-D image sequence input, `InputSize` is vector of four elements `[h w d c]`, where `h` is the image height, `w` is the image width, `d` is the image depth, and `c` is the number of channels of the image.

Example: 100

#### Normalization — Data normalization

'none' (default) | 'zerocenter' | 'zscore' | 'rescale-symmetric' | 'rescale-zero-one' | function handle

Data normalization to apply every time data is forward propagated through the input layer, specified as one of the following:

- 'zerocenter' — Subtract the mean specified by `Mean`.
- 'zscore' — Subtract the mean specified by `Mean` and divide by `StandardDeviation`.
- 'rescale-symmetric' — Rescale the input to be in the range [-1, 1] using the minimum and maximum values specified by `Min` and `Max`, respectively.
- 'rescale-zero-one' — Rescale the input to be in the range [0, 1] using the minimum and maximum values specified by `Min` and `Max`, respectively.
- 'none' — Do not normalize the input data.
- function handle — Normalize the data using the specified function. The function must be of the form  $Y = \text{func}(X)$ , where  $X$  is the input data, and the output  $Y$  is the normalized data.

---

**Tip** The software, by default, automatically calculates the normalization statistics at training time. To save time when training, specify the required statistics for normalization and set the 'ResetInputNormalization' option in `trainingOptions` to `false`.

---

If the input data contains padding, then the layer ignored padding values when normalizing the input data.

#### **NormalizationDimension — Normalization dimension**

'auto' (default) | 'channel' | 'element' | 'all'

Normalization dimension, specified as one of the following:

- 'auto' - If the training option is `false` and you specify any of the normalization statistics (`Mean`, `StandardDeviation`, `Min`, or `Max`), then normalize over the dimensions matching the statistics. Otherwise, recalculate the statistics at training time and apply channel-wise normalization.
- 'channel' - Channel-wise normalization.
- 'element' - Element-wise normalization.
- 'all' - Normalize all values using scalar statistics.

#### **Mean — Mean for zero-center and z-score normalization**

[] (default) | numeric array | numeric scalar

Mean for zero-center and z-score normalization, specified as a numeric array, or empty.

- For vector sequence input, `Mean` must be a `InputSize`-by-1 vector of means per channel or a numeric scalar.
- For 2-D image sequence input, `Mean` must be a numeric array of the same size as `InputSize`, a 1-by-1-by- $C$  array of means per channel, or a numeric scalar, where  $C$  is the number of channels of the input. For 2-D image sequences, the number of channels is `InputSize(3)`.
- For 3-D image sequence input, `Mean` must be a numeric array of the same size as `InputSize`, a 1-by-1-by-1-by- $C$  array of means per channel, or a numeric scalar, where  $C$  is the number of channels of the input. For 3-D image sequences, the number of channels is `InputSize(4)`.

If you specify the `Mean` property, then `Normalization` must be 'zerocenter' or 'zscore'. If `Mean` is [], then the software calculates the mean at training time.

You can set this property when creating networks without training (for example, when assembling networks using `assembleNetwork`).

Data Types: `single` | `double` | `int8` | `int16` | `int32` | `int64` | `uint8` | `uint16` | `uint32` | `uint64`

**StandardDeviation — Standard deviation**

[] (default) | numeric array | numeric scalar

Standard deviation used for z-score normalization, specified as a numeric array, a numeric scalar, or empty.

- For vector sequence input, `StandardDeviation` must be a `InputSize`-by-1 vector of standard deviations per channel or a numeric scalar.
- For 2-D image sequence input, `StandardDeviation` must be a numeric array of the same size as `InputSize`, a 1-by-1-by- $C$  array of standard deviations per channel, or a numeric scalar, where  $C$  is the number of channels of the input. For 2-D image sequences, the number of channels is `InputSize(3)`.
- For 3-D image sequence input, `StandardDeviation` must be a numeric array of the same size as `InputSize`, a 1-by-1-by-1-by- $C$  array of standard deviations per channel, or a numeric scalar, where  $C$  is the number of channels of the input. For 3-D image sequences, the number of channels is `InputSize(4)`.

If you specify the `StandardDeviation` property, then `Normalization` must be `'zscore'`. If `StandardDeviation` is [], then the software calculates the standard deviation at training time.

You can set this property when creating networks without training (for example, when assembling networks using `assembleNetwork`).

Data Types: `single` | `double` | `int8` | `int16` | `int32` | `int64` | `uint8` | `uint16` | `uint32` | `uint64`

**Min — Minimum value for rescaling**

[] (default) | numeric array | numeric scalar

Minimum value for rescaling, specified as a numeric array, or empty.

- For vector sequence input, `Min` must be a `InputSize`-by-1 vector of means per channel or a numeric scalar.
- For 2-D image sequence input, `Min` must be a numeric array of the same size as `InputSize`, a 1-by-1-by- $C$  array of minima per channel, or a numeric scalar, where  $C$  is the number of channels of the input. For 2-D image sequences, the number of channels is `InputSize(3)`.
- For 3-D image sequence input, `Min` must be a numeric array of the same size as `InputSize`, a 1-by-1-by-1-by- $C$  array of minima per channel, or a numeric scalar, where  $C$  is the number of channels of the input. For 3-D image sequences, the number of channels is `InputSize(4)`.

If you specify the `Min` property, then `Normalization` must be `'rescale-symmetric'` or `'rescale-zero-one'`. If `Min` is [], then the software calculates the minima at training time.

You can set this property when creating networks without training (for example, when assembling networks using `assembleNetwork`).

Data Types: `single` | `double` | `int8` | `int16` | `int32` | `int64` | `uint8` | `uint16` | `uint32` | `uint64`

**Max — Maximum value for rescaling**

[] (default) | numeric array | numeric scalar

Maximum value for rescaling, specified as a numeric array, or empty.

- For vector sequence input, `Max` must be a `InputSize`-by-1 vector of means per channel or a numeric scalar.

- For 2-D image sequence input, `Max` must be a numeric array of the same size as `InputSize`, a 1-by-1-by- $C$  array of maxima per channel, or a numeric scalar, where  $C$  is the number of channels of the input. For 2-D image sequences, the number of channels is `InputSize(3)`.
- For 3-D image sequence input, `Max` must be a numeric array of the same size as `InputSize`, a 1-by-1-by-1-by- $C$  array of maxima per channel, or a numeric scalar, where  $C$  is the number of channels of the input. For 3-D image sequences, the number of channels is `InputSize(4)`.

If you specify the `Max` property, then `Normalization` must be `'rescale-symmetric'` or `'rescale-zero-one'`. If `Max` is `[]`, then the software calculates the maxima at training time.

You can set this property when creating networks without training (for example, when assembling networks using `assembleNetwork`).

Data Types: `single` | `double` | `int8` | `int16` | `int32` | `int64` | `uint8` | `uint16` | `uint32` | `uint64`

## Layer

### **Name — Layer name**

`''` (default) | character vector | string scalar

Layer name, specified as a character vector or a string scalar. To include a layer in a layer graph, you must specify a nonempty unique layer name. If you train a series network with the layer and `Name` is set to `''`, then the software automatically assigns a name to the layer at training time.

Data Types: `char` | `string`

### **NumInputs — Number of inputs**

0 (default)

Number of inputs of the layer. The layer has no inputs.

Data Types: `double`

### **InputNames — Input names**

`{}` (default)

Input names of the layer. The layer has no inputs.

Data Types: `cell`

### **NumOutputs — Number of outputs**

1 (default)

Number of outputs of the layer. This layer has a single output only.

Data Types: `double`

### **OutputNames — Output names**

`{'out'}` (default)

Output names of the layer. This layer has a single output only.

Data Types: `cell`

## Examples

## Create Sequence Input Layer

Create a sequence input layer with the name 'seq1' and an input size of 12.

```
layer = sequenceInputLayer(12, 'Name', 'seq1')
```

```
layer =
  SequenceInputLayer with properties:
```

```
        Name: 'seq1'
        InputSize: 12
```

```
Hyperparameters
    Normalization: 'none'
    NormalizationDimension: 'auto'
```

Include an LSTM layer in a Layer array.

```
inputSize = 12;
numHiddenUnits = 100;
numClasses = 9;
```

```
layers = [ ...
  sequenceInputLayer(inputSize)
  lstmLayer(numHiddenUnits, 'OutputMode', 'last')
  fullyConnectedLayer(numClasses)
  softmaxLayer
  classificationLayer]
```

```
layers =
  5x1 Layer array with layers:
```

1	''	Sequence Input	Sequence input with 12 dimensions
2	''	LSTM	LSTM with 100 hidden units
3	''	Fully Connected	9 fully connected layer
4	''	Softmax	softmax
5	''	Classification Output	crossentropyex

## Create Sequence Input Layer for Image Sequences

Create a sequence input layer for sequences of 224-224 RGB images with the name 'seq1'.

```
layer = sequenceInputLayer([224 224 3], 'Name', 'seq1')
```

```
layer =
  SequenceInputLayer with properties:
```

```
        Name: 'seq1'
        InputSize: [224 224 3]
```

```
Hyperparameters
    Normalization: 'none'
    NormalizationDimension: 'auto'
```

## Train Network for Sequence Classification

Train a deep learning LSTM network for sequence-to-label classification.

Load the Japanese Vowels data set as described in [1] and [2]. `XTrain` is a cell array containing 270 sequences of varying length with a feature dimension of 12. `Y` is a categorical vector of labels 1,2,...,9. The entries in `XTrain` are matrices with 12 rows (one row for each feature) and a varying number of columns (one column for each time step).

```
[XTrain,YTrain] = japaneseVowelsTrainData;
```

Visualize the first time series in a plot. Each line corresponds to a feature.

```
figure
plot(XTrain{1}')
title("Training Observation 1")
numFeatures = size(XTrain{1},1);
legend("Feature " + string(1:numFeatures),'Location','northeastoutside')
```

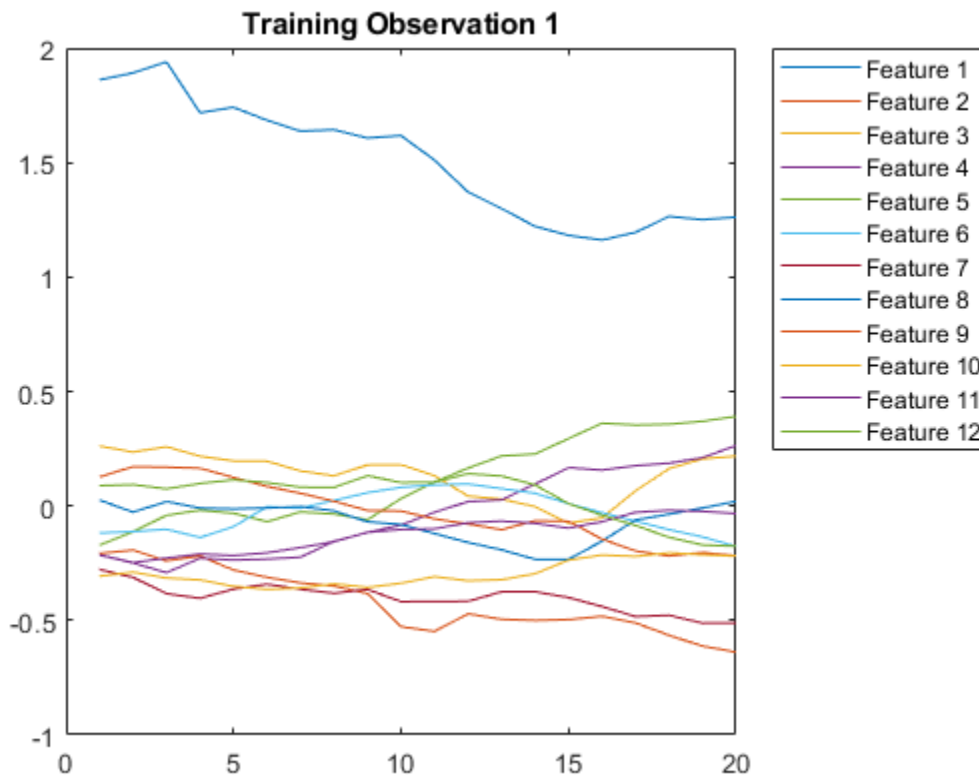

Define the LSTM network architecture. Specify the input size as 12 (the number of features of the input data). Specify an LSTM layer to have 100 hidden units and to output the last element of the sequence. Finally, specify nine classes by including a fully connected layer of size 9, followed by a softmax layer and a classification layer.

```
inputSize = 12;
numHiddenUnits = 100;
numClasses = 9;
```



```
layers = [ ...
    sequenceInputLayer(inputSize)
    lstmLayer(numHiddenUnits,'OutputMode','last')
    fullyConnectedLayer(numClasses)
    softmaxLayer
    classificationLayer]
```

```
layers =
    5x1 Layer array with layers:
```

1	''	Sequence Input	Sequence input with 12 dimensions
2	''	LSTM	LSTM with 100 hidden units
3	''	Fully Connected	9 fully connected layer
4	''	Softmax	softmax
5	''	Classification Output	crossentropyex

Specify the training options. Specify the solver as 'adam' and 'GradientThreshold' as 1. Set the mini-batch size to 27 and set the maximum number of epochs to 100.

Because the mini-batches are small with short sequences, the CPU is better suited for training. Set 'ExecutionEnvironment' to 'cpu'. To train on a GPU, if available, set 'ExecutionEnvironment' to 'auto' (the default value).

```
maxEpochs = 100;
miniBatchSize = 27;

options = trainingOptions('adam', ...
    'ExecutionEnvironment','cpu', ...
    'MaxEpochs',maxEpochs, ...
    'MiniBatchSize',miniBatchSize, ...
    'GradientThreshold',1, ...
    'Verbose',false, ...
    'Plots','training-progress');
```

Train the LSTM network with the specified training options.

```
net = trainNetwork(XTrain,YTrain,layers,options);
```

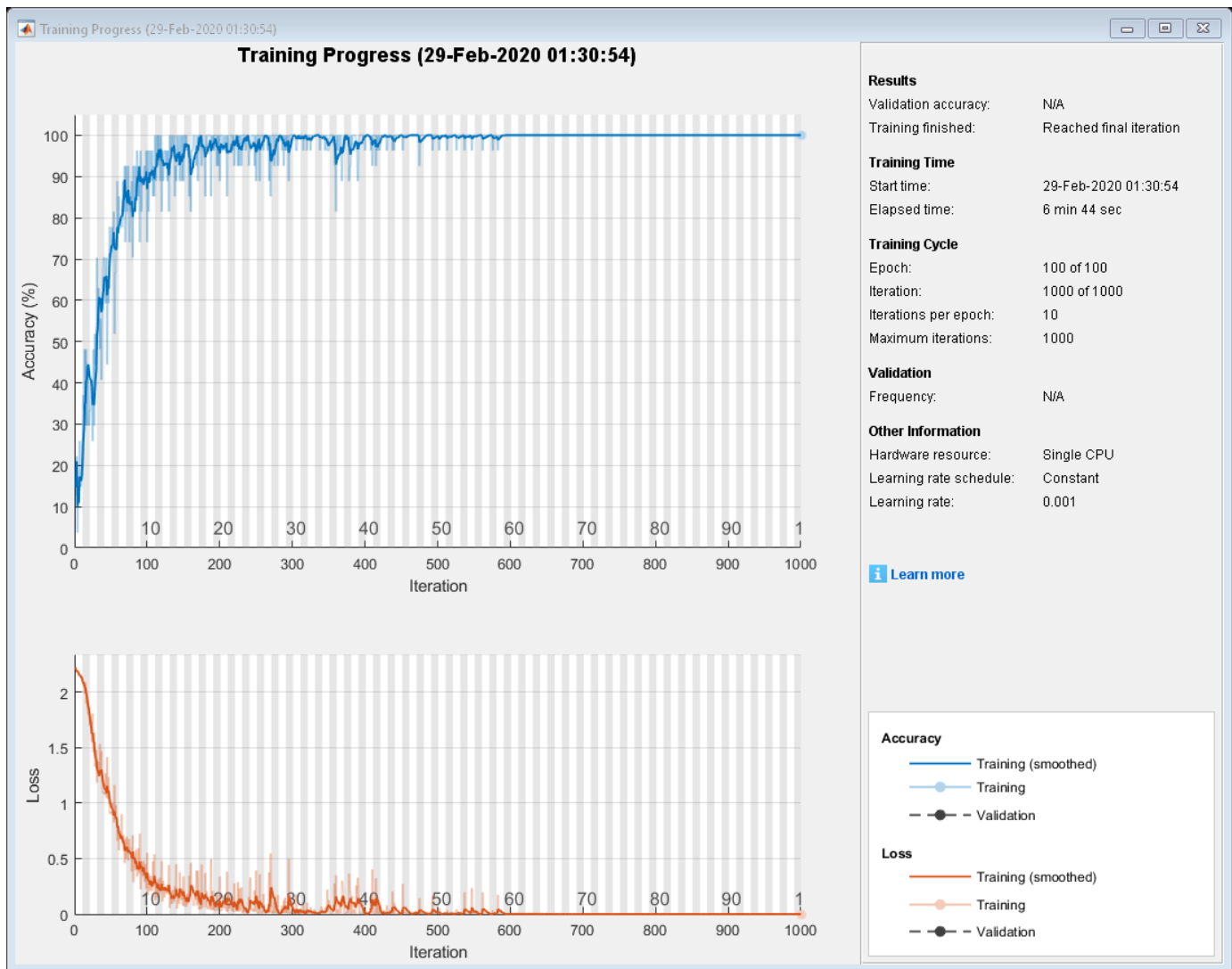

Load the test set and classify the sequences into speakers.

```
[XTest,YTest] = japaneseVowelsTestData;
```

Classify the test data. Specify the same mini-batch size used for training.

```
YPred = classify(net,XTest,'MiniBatchSize',miniBatchSize);
```

Calculate the classification accuracy of the predictions.

```
acc = sum(YPred == YTest)./numel(YTest)
```

```
acc = 0.9486
```

### Classification LSTM Networks

To create an LSTM network for sequence-to-label classification, create a layer array containing a sequence input layer, an LSTM layer, a fully connected layer, a softmax layer, and a classification output layer.

Set the size of the sequence input layer to the number of features of the input data. Set the size of the fully connected layer to the number of classes. You do not need to specify the sequence length.

For the LSTM layer, specify the number of hidden units and the output mode 'last'.

```
numFeatures = 12;
numHiddenUnits = 100;
numClasses = 9;
layers = [ ...
    sequenceInputLayer(numFeatures)
    lstmLayer(numHiddenUnits, 'OutputMode', 'last')
    fullyConnectedLayer(numClasses)
    softmaxLayer
    classificationLayer];
```

For an example showing how to train an LSTM network for sequence-to-label classification and classify new data, see “Sequence Classification Using Deep Learning”.

To create an LSTM network for sequence-to-sequence classification, use the same architecture as for sequence-to-label classification, but set the output mode of the LSTM layer to 'sequence'.

```
numFeatures = 12;
numHiddenUnits = 100;
numClasses = 9;
layers = [ ...
    sequenceInputLayer(numFeatures)
    lstmLayer(numHiddenUnits, 'OutputMode', 'sequence')
    fullyConnectedLayer(numClasses)
    softmaxLayer
    classificationLayer];
```

## Regression LSTM Networks

To create an LSTM network for sequence-to-one regression, create a layer array containing a sequence input layer, an LSTM layer, a fully connected layer, and a regression output layer.

Set the size of the sequence input layer to the number of features of the input data. Set the size of the fully connected layer to the number of responses. You do not need to specify the sequence length.

For the LSTM layer, specify the number of hidden units and the output mode 'last'.

```
numFeatures = 12;
numHiddenUnits = 125;
numResponses = 1;

layers = [ ...
    sequenceInputLayer(numFeatures)
    lstmLayer(numHiddenUnits, 'OutputMode', 'last')
    fullyConnectedLayer(numResponses)
    regressionLayer];
```

To create an LSTM network for sequence-to-sequence regression, use the same architecture as for sequence-to-one regression, but set the output mode of the LSTM layer to 'sequence'.

```
numFeatures = 12;
numHiddenUnits = 125;
numResponses = 1;
```

```
layers = [ ...
    sequenceInputLayer(numFeatures)
    lstmLayer(numHiddenUnits, 'OutputMode', 'sequence')
    fullyConnectedLayer(numResponses)
    regressionLayer];
```

For an example showing how to train an LSTM network for sequence-to-sequence regression and predict on new data, see “Sequence-to-Sequence Regression Using Deep Learning”.

### Deeper LSTM Networks

You can make LSTM networks deeper by inserting extra LSTM layers with the output mode 'sequence' before the LSTM layer. To prevent overfitting, you can insert dropout layers after the LSTM layers.

For sequence-to-label classification networks, the output mode of the last LSTM layer must be 'last'.

```
numFeatures = 12;
numHiddenUnits1 = 125;
numHiddenUnits2 = 100;
numClasses = 9;
layers = [ ...
    sequenceInputLayer(numFeatures)
    lstmLayer(numHiddenUnits1, 'OutputMode', 'sequence')
    dropoutLayer(0.2)
    lstmLayer(numHiddenUnits2, 'OutputMode', 'last')
    dropoutLayer(0.2)
    fullyConnectedLayer(numClasses)
    softmaxLayer
    classificationLayer];
```

For sequence-to-sequence classification networks, the output mode of the last LSTM layer must be 'sequence'.

```
numFeatures = 12;
numHiddenUnits1 = 125;
numHiddenUnits2 = 100;
numClasses = 9;
layers = [ ...
    sequenceInputLayer(numFeatures)
    lstmLayer(numHiddenUnits1, 'OutputMode', 'sequence')
    dropoutLayer(0.2)
    lstmLayer(numHiddenUnits2, 'OutputMode', 'sequence')
    dropoutLayer(0.2)
    fullyConnectedLayer(numClasses)
    softmaxLayer
    classificationLayer];
```

### Create Network for Video Classification

Create a deep learning network for data containing sequences of images, such as video and medical image data.

- To input sequences of images into a network, use a sequence input layer.
- To apply convolutional operations independently to each time step, first convert the sequences of images to an array of images using a sequence folding layer.
- To restore the sequence structure after performing these operations, convert this array of images back to image sequences using a sequence unfolding layer.
- To convert images to feature vectors, use a flatten layer.

You can then input vector sequences into LSTM and BiLSTM layers.

### Define Network Architecture

Create a classification LSTM network that classifies sequences of 28-by-28 grayscale images into 10 classes.

Define the following network architecture:

- A sequence input layer with an input size of [28 28 1].
- A convolution, batch normalization, and ReLU layer block with 20 5-by-5 filters.
- An LSTM layer with 200 hidden units that outputs the last time step only.
- A fully connected layer of size 10 (the number of classes) followed by a softmax layer and a classification layer.

To perform the convolutional operations on each time step independently, include a sequence folding layer before the convolutional layers. LSTM layers expect vector sequence input. To restore the sequence structure and reshape the output of the convolutional layers to sequences of feature vectors, insert a sequence unfolding layer and a flatten layer between the convolutional layers and the LSTM layer.

```
inputSize = [28 28 1];
filterSize = 5;
numFilters = 20;
numHiddenUnits = 200;
numClasses = 10;

layers = [ ...
    sequenceInputLayer(inputSize, 'Name', 'input')

    sequenceFoldingLayer('Name', 'fold')

    convolution2dLayer(filterSize, numFilters, 'Name', 'conv')
    batchNormalizationLayer('Name', 'bn')
    reluLayer('Name', 'relu')

    sequenceUnfoldingLayer('Name', 'unfold')
    flattenLayer('Name', 'flatten')

    lstmLayer(numHiddenUnits, 'OutputMode', 'last', 'Name', 'lstm')

    fullyConnectedLayer(numClasses, 'Name', 'fc')
    softmaxLayer('Name', 'softmax')
    classificationLayer('Name', 'classification')];
```

Convert the layers to a layer graph and connect the `miniBatchSize` output of the sequence folding layer to the corresponding input of the sequence unfolding layer.

```
lgraph = layerGraph(layers);
lgraph = connectLayers(lgraph, 'fold/miniBatchSize', 'unfold/miniBatchSize');
```

View the final network architecture using the `plot` function.

```
figure
plot(lgraph)
```

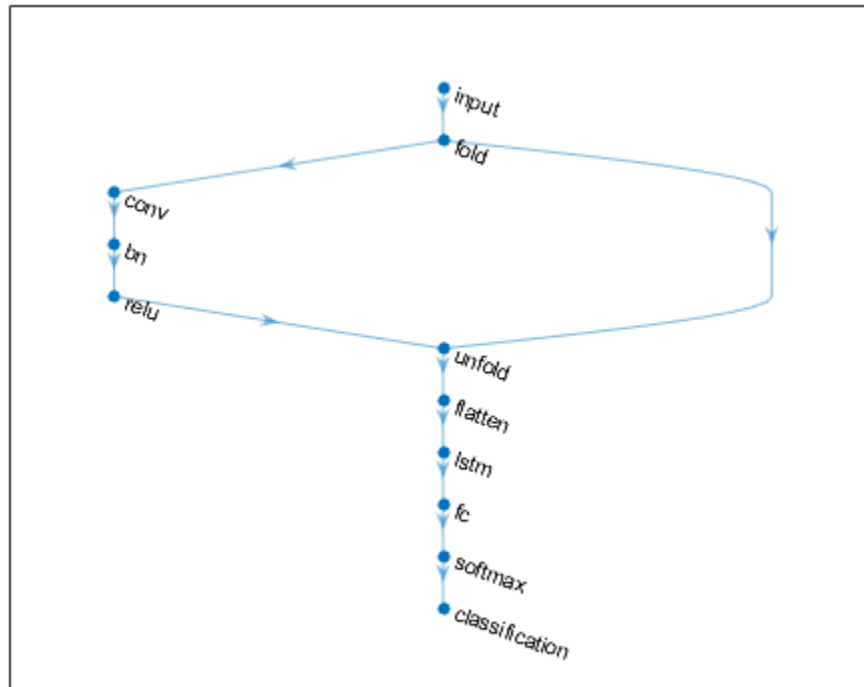

## Compatibility Considerations

### **sequenceInputLayer, by default, uses channel-wise normalization for zero-center normalization**

*Behavior change in future release*

Starting in R2019b, `sequenceInputLayer`, by default, uses channel-wise normalization for zero-center normalization. In previous versions, this layer uses element-wise normalization. To reproduce this behavior, set the `NormalizationDimension` option of this layer to `'element'`.

### **sequenceInputLayer ignores padding values when normalizing**

*Behavior changed in R2020a*

Starting in R2020a, `sequenceInputLayer` objects ignore padding values in the input data when normalizing. This means that the `Normalization` option in the `sequenceInputLayer` now makes training invariant to data operations, for example, `'zerocenter'` normalization now implies that the training results are invariant to the mean of the data.

If you train on padded sequences, then the calculated normalization factors may be different in earlier versions and can produce different results.

## References

- [1] M. Kudo, J. Toyama, and M. Shimbo. "Multidimensional Curve Classification Using Passing-Through Regions." *Pattern Recognition Letters*. Vol. 20, No. 11-13, pages 1103-1111.
- [2] *UCI Machine Learning Repository: Japanese Vowels Dataset*. <https://archive.ics.uci.edu/ml/datasets/Japanese+Vowels>

## Extended Capabilities

### GPU Code Generation

Generate CUDA® code for NVIDIA® GPUs using GPU Coder™.

### See Also

**Deep Network Designer** | `bilstmLayer` | `classifyAndUpdateState` | `flattenLayer` | `gruLayer` | `lstmLayer` | `predictAndUpdateState` | `resetState` | `sequenceFoldingLayer` | `sequenceUnfoldingLayer`

### Topics

"Sequence Classification Using Deep Learning"  
"Time Series Forecasting Using Deep Learning"  
"Sequence-to-Sequence Classification Using Deep Learning"  
"Classify Videos Using Deep Learning"  
"Visualize Activations of LSTM Network"  
"Long Short-Term Memory Networks"  
"Specify Layers of Convolutional Neural Network"  
"Set Up Parameters and Train Convolutional Neural Network"  
"Deep Learning in MATLAB"  
"List of Deep Learning Layers"

### Introduced in R2017b

# sequenceUnfoldingLayer

Sequence unfolding layer

## Description

A sequence unfolding layer restores the sequence structure of the input data after sequence folding.

To use a sequence unfolding layer, you must connect the `miniBatchSize` output of the corresponding sequence folding layer to the `miniBatchSize` input of the sequence unfolding layer. For an example, see “Create Network for Video Classification” on page 1-711.

## Creation

### Syntax

```
layer = sequenceUnfoldingLayer  
layer = sequenceUnfoldingLayer('Name',Name)
```

### Description

`layer = sequenceUnfoldingLayer` creates a sequence unfolding layer.

`layer = sequenceUnfoldingLayer('Name',Name)` creates a sequence unfolding layer and sets the optional `Name` property using a name-value pair. For example, `sequenceUnfoldingLayer('Name','unfold1')` creates a sequence unfolding layer with the name 'unfold1'. Enclose the property name in single quotes.

## Properties

### Name — Layer name

' ' (default) | character vector | string scalar

Layer name, specified as a character vector or a string scalar. To include a layer in a layer graph, you must specify a nonempty unique layer name. If you train a series network with the layer and `Name` is set to ' ', then the software automatically assigns a name to the layer at training time.

Data Types: `char` | `string`

### NumInputs — Number of inputs

2 (default)

Number of inputs of the layer.

This layer has two inputs:

- 'in' - Input feature map.



- 'miniBatchSize' - Size of the mini-batch from the corresponding sequence folding layer. This output must be connected to the 'miniBatchSize' output of the corresponding sequence folding layer.

Data Types: double

### InputNames — Input names

{'in', 'miniBatchSize'} (default)

Input names of the layer.

This layer has two inputs:

- 'in' - Input feature map.
- 'miniBatchSize' - Size of the mini-batch from the corresponding sequence folding layer. This output must be connected to the 'miniBatchSize' output of the corresponding sequence folding layer.

Data Types: cell

### NumOutputs — Number of outputs

1 (default)

Number of outputs of the layer. This layer has a single output only.

Data Types: double

### OutputNames — Output names

{'out'} (default)

Output names of the layer. This layer has a single output only.

Data Types: cell

## Examples

### Create Sequence Unfolding Layer

Create a sequence unfolding layer with the name 'unfold1'.

```
layer = sequenceUnfoldingLayer('Name', 'unfold1')
```

```
layer =
  SequenceUnfoldingLayer with properties:
      Name: 'unfold1'
      NumInputs: 2
      InputNames: {'in' 'miniBatchSize'}
```

## Create Network for Video Classification

Create a deep learning network for data containing sequences of images, such as video and medical image data.

- To input sequences of images into a network, use a sequence input layer.
- To apply convolutional operations independently to each time step, first convert the sequences of images to an array of images using a sequence folding layer.
- To restore the sequence structure after performing these operations, convert this array of images back to image sequences using a sequence unfolding layer.
- To convert images to feature vectors, use a flatten layer.

You can then input vector sequences into LSTM and BiLSTM layers.

## Define Network Architecture

Create a classification LSTM network that classifies sequences of 28-by-28 grayscale images into 10 classes.

Define the following network architecture:

- A sequence input layer with an input size of [28 28 1].
- A convolution, batch normalization, and ReLU layer block with 20 5-by-5 filters.
- An LSTM layer with 200 hidden units that outputs the last time step only.
- A fully connected layer of size 10 (the number of classes) followed by a softmax layer and a classification layer.

To perform the convolutional operations on each time step independently, include a sequence folding layer before the convolutional layers. LSTM layers expect vector sequence input. To restore the sequence structure and reshape the output of the convolutional layers to sequences of feature vectors, insert a sequence unfolding layer and a flatten layer between the convolutional layers and the LSTM layer.

```
inputSize = [28 28 1];
filterSize = 5;
numFilters = 20;
numHiddenUnits = 200;
numClasses = 10;

layers = [ ...
    sequenceInputLayer(inputSize, 'Name', 'input')

    sequenceFoldingLayer('Name', 'fold')

    convolution2dLayer(filterSize, numFilters, 'Name', 'conv')
    batchNormalizationLayer('Name', 'bn')
    reluLayer('Name', 'relu')

    sequenceUnfoldingLayer('Name', 'unfold')
    flattenLayer('Name', 'flatten')

    lstmLayer(numHiddenUnits, 'OutputMode', 'last', 'Name', 'lstm')

    fullyConnectedLayer(numClasses, 'Name', 'fc')
```

```
softmaxLayer('Name','softmax')
classificationLayer('Name','classification')];
```

Convert the layers to a layer graph and connect the `miniBatchSize` output of the sequence folding layer to the corresponding input of the sequence unfolding layer.

```
lgraph = layerGraph(layers);
lgraph = connectLayers(lgraph,'fold/miniBatchSize','unfold/miniBatchSize');
```

View the final network architecture using the `plot` function.

```
figure
plot(lgraph)
```

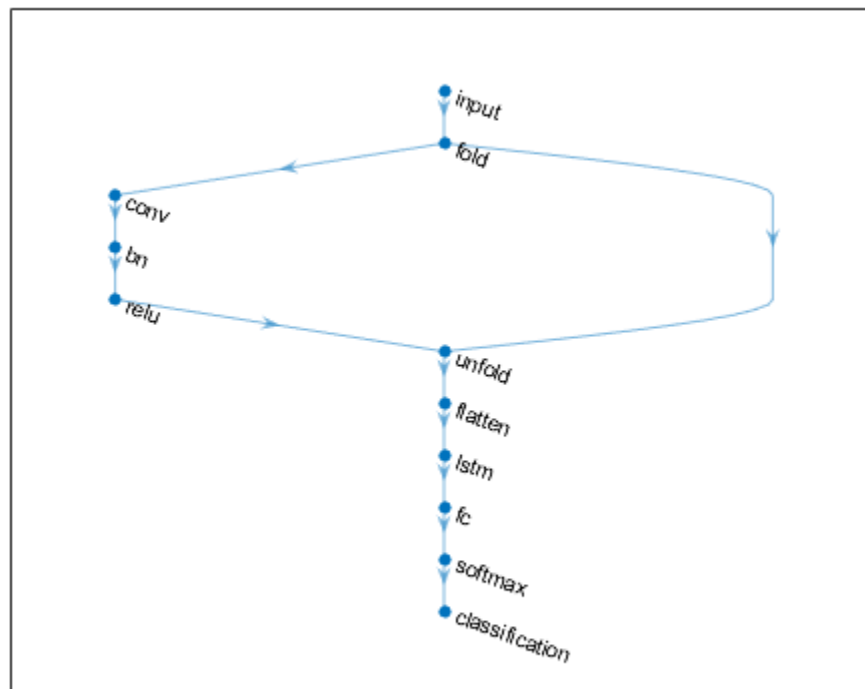

## See Also

[bilstmLayer](#) | [classifyAndUpdateState](#) | [flattenLayer](#) | [gruLayer](#) | [lstmLayer](#) | [predictAndUpdateState](#) | [resetState](#) | [sequenceFoldingLayer](#) | [sequenceInputLayer](#)

## Topics

“Classify Videos Using Deep Learning”  
 “Classify Videos Using Deep Learning”  
 “Sequence Classification Using Deep Learning”  
 “Time Series Forecasting Using Deep Learning”  
 “Sequence-to-Sequence Classification Using Deep Learning”  
 “Long Short-Term Memory Networks”  
 “Visualize Activations of LSTM Network”

“Specify Layers of Convolutional Neural Network”  
“Set Up Parameters and Train Convolutional Neural Network”  
“Deep Learning in MATLAB”  
“List of Deep Learning Layers”

**Introduced in R2019a**

# SeriesNetwork

Series network for deep learning

## Description

A series network is a neural network for deep learning with layers arranged one after the other. It has a single input layer and a single output layer.

## Creation

There are several ways to create a `SeriesNetwork` object:

- Load a pretrained network using `alexnet`, `darknet19`, `vgg16`, or `vgg19`. For an example, see “Load Pretrained AlexNet Convolutional Neural Network” on page 1-716.
- Import a pretrained network from Keras using `importKerasNetwork`. For an example, see “Import and Plot Keras Network” on page 1-493.
- Import a pretrained network from Caffe using `importCaffeNetwork`. For an example, see “Import Caffe Network” on page 1-473.
- Train or fine-tune a network using `trainNetwork`. For an example, see “Train Network for Image Classification” on page 1-717.

---

**Note** To learn about other pretrained networks, such as `googlenet` and `resnet50`, see “Pretrained Deep Neural Networks”.

---

## Properties

### Layers — Network layers

Layer array

Network layers, specified as a Layer array.

### InputNames — Network input layer names

cell array

Network input layer names, specified as a cell array of character vectors.

Data Types: `cell`

### OutputNames — Network output layer names

cell array

Network output layer names, specified as a cell array of character vectors.

Data Types: `cell`

## Object Functions

activations	Compute deep learning network layer activations
classify	Classify data using a trained deep learning neural network
predict	Predict responses using a trained deep learning neural network
predictAndUpdateState	Predict responses using a trained recurrent neural network and update the network state
classifyAndUpdateState	Classify data using a trained recurrent neural network and update the network state
resetState	Reset the state of a recurrent neural network
plot	Plot neural network layer graph

## Examples

### Load Pretrained AlexNet Convolutional Neural Network

Load a pretrained AlexNet convolutional neural network and examine the layers and classes.

Load the pretrained AlexNet network using `alexnet`. The output `net` is a `SeriesNetwork` object.

```
net = alexnet
```

```
net =
  SeriesNetwork with properties:

    Layers: [25x1 nnet.cnn.layer.Layer]
```

Using the `Layers` property, view the network architecture. The network comprises of 25 layers. There are 8 layers with learnable weights: 5 convolutional layers, and 3 fully connected layers.

```
net.Layers
```

```
ans =
  25x1 Layer array with layers:

   1  'data'      Image Input          227x227x3 images with 'zerocenter' normalizati
   2  'conv1'     Convolution          96 11x11x3 convolutions with stride [4 4] and
   3  'relu1'    ReLU                 ReLU
   4  'norm1'    Cross Channel Normalization cross channel normalization with 5 channels pe
   5  'pool1'    Max Pooling          3x3 max pooling with stride [2 2] and padding
   6  'conv2'    Grouped Convolution  2 groups of 128 5x5x48 convolutions with stride
   7  'relu2'    ReLU                 ReLU
   8  'norm2'    Cross Channel Normalization cross channel normalization with 5 channels pe
   9  'pool2'    Max Pooling          3x3 max pooling with stride [2 2] and padding
  10  'conv3'    Convolution          384 3x3x256 convolutions with stride [1 1] and
  11  'relu3'    ReLU                 ReLU
  12  'conv4'    Grouped Convolution  2 groups of 192 3x3x192 convolutions with stri
  13  'relu4'    ReLU                 ReLU
  14  'conv5'    Grouped Convolution  2 groups of 128 3x3x192 convolutions with stri
  15  'relu5'    ReLU                 ReLU
  16  'pool5'    Max Pooling          3x3 max pooling with stride [2 2] and padding
  17  'fc6'      Fully Connected      4096 fully connected layer
  18  'relu6'    ReLU                 ReLU
  19  'drop6'    Dropout              50% dropout
  20  'fc7'      Fully Connected      4096 fully connected layer
```

```

21 'relu7'      ReLU                ReLU
22 'drop7'     Dropout            50% dropout
23 'fc8'       Fully Connected    1000 fully connected layer
24 'prob'      Softmax            softmax
25 'output'    Classification Output crossentropyex with 'tench' and 999 other classes

```

You can view the names of the classes learned by the network by viewing the `Classes` property of the classification output layer (the final layer). View the first 10 classes by selecting the first 10 elements.

```
net.Layers(end).Classes(1:10)
```

```
ans = 10x1 categorical array
    tench
  goldfish
great white shark
  tiger shark
  hammerhead
  electric ray
  stingray
    cock
    hen
  ostrich

```

## Import Layers from Caffe Network

Specify the example file `'digitsnet.prototxt'` to import.

```
protofile = 'digitsnet.prototxt';
```

Import the network layers.

```
layers = importCaffeLayers(protofile)
```

```
layers =
    1x7 Layer array with layers:
    1 'testdata'  Image Input          28x28x1 images
    2 'conv1'     Convolution          20 5x5x1 convolutions with stride [1 1] and padding [0 0]
    3 'relu1'     ReLU                 ReLU
    4 'pool1'     Max Pooling          2x2 max pooling with stride [2 2] and padding [0 0]
    5 'ip1'       Fully Connected      10 fully connected layer
    6 'loss'      Softmax              softmax
    7 'output'    Classification Output crossentropyex with 'class1', 'class2', and 8 other classes

```

## Train Network for Image Classification

Load the data as an `ImageDatastore` object.

```
digitDatasetPath = fullfile(matlabroot,'toolbox','nnet', ...
    'nndemos','nndatasets','DigitDataset');
imds = imageDatastore(digitDatasetPath, ...
    'IncludeSubfolders',true, ...
    'LabelSource','foldernames');
```

The datastore contains 10,000 synthetic images of digits from 0 to 9. The images are generated by applying random transformations to digit images created with different fonts. Each digit image is 28-by-28 pixels. The datastore contains an equal number of images per category.

Display some of the images in the datastore.

```
figure
numImages = 10000;
perm = randperm(numImages,20);
for i = 1:20
    subplot(4,5,i);
    imshow(imds.Files{perm(i)});
end
```

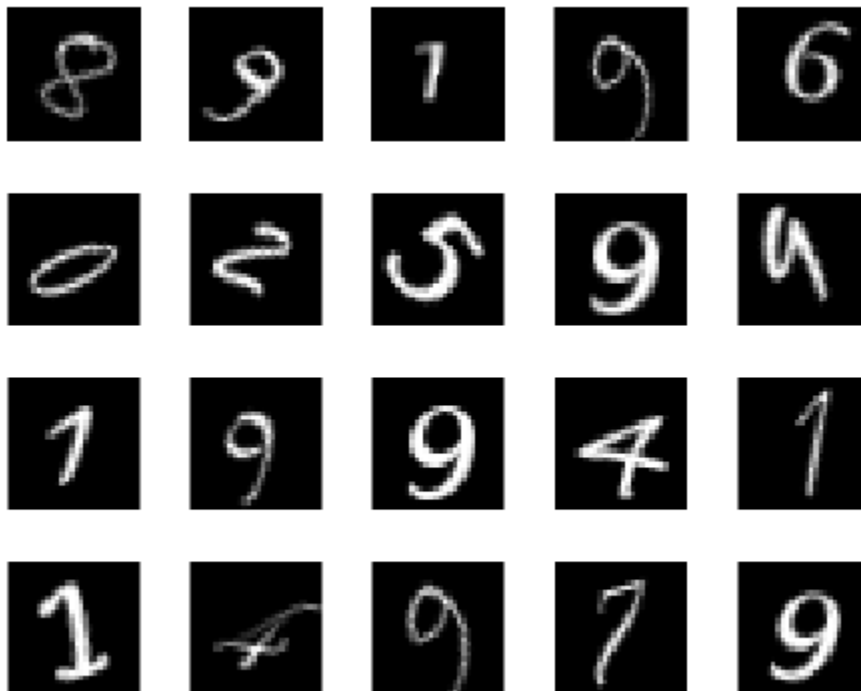

Divide the datastore so that each category in the training set has 750 images and the testing set has the remaining images from each label.

```
numTrainingFiles = 750;
[imdsTrain,imdsTest] = splitEachLabel(imds,numTrainingFiles,'randomize');
```

`splitEachLabel` splits the image files in `digitData` into two new datastores, `imdsTrain` and `imdsTest`.

Define the convolutional neural network architecture.

```
layers = [ ...
    imageInputLayer([28 28 1])
```



```
convolution2dLayer(5,20)
reluLayer
maxPooling2dLayer(2,'Stride',2)
fullyConnectedLayer(10)
softmaxLayer
classificationLayer];
```

Set the options to the default settings for the stochastic gradient descent with momentum. Set the maximum number of epochs at 20, and start the training with an initial learning rate of 0.0001.

```
options = trainingOptions('sgdm', ...
    'MaxEpochs',20,...
    'InitialLearnRate',1e-4, ...
    'Verbose',false, ...
    'Plots','training-progress');
```

Train the network.

```
net = trainNetwork(imdsTrain, layers, options);
```

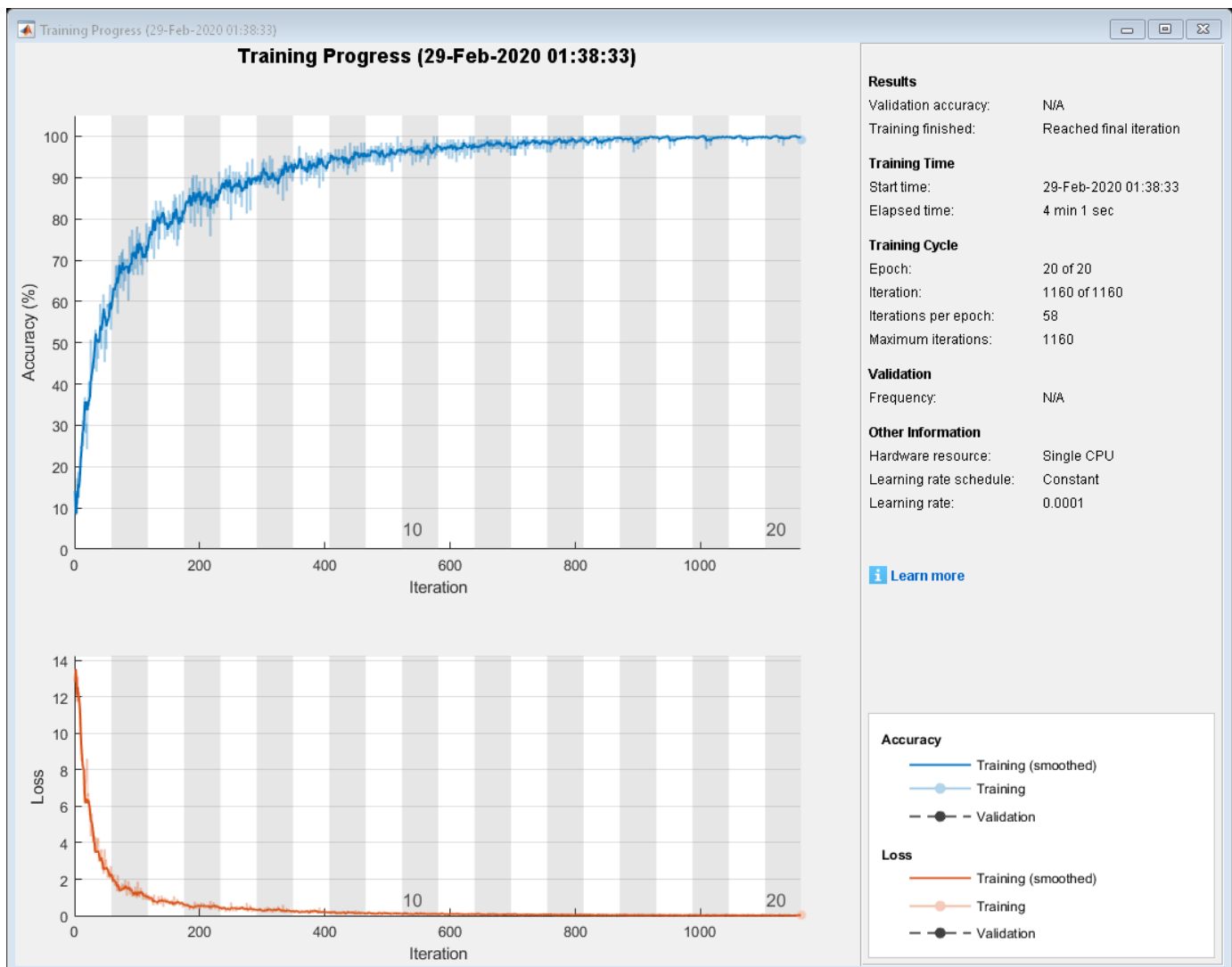

Run the trained network on the test set, which was not used to train the network, and predict the image labels (digits).

```
YPred = classify(net, imdsTest);  
YTest = imdsTest.Labels;
```

Calculate the accuracy. The accuracy is the ratio of the number of true labels in the test data matching the classifications from `classify` to the number of images in the test data.

```
accuracy = sum(YPred == YTest)/numel(YTest)
```

```
accuracy = 0.9412
```

## Extended Capabilities

### C/C++ Code Generation

Generate C and C++ code using MATLAB® Coder™.

Usage notes and limitations:

- Only the `activations` and `predict` object functions are supported.
- To create a `SeriesNetwork` object for code generation, see “Load Pretrained Networks for Code Generation” (MATLAB Coder).

### GPU Code Generation

Generate CUDA® code for NVIDIA® GPUs using GPU Coder™.

Usage notes and limitations:

- Only the `activations`, `classify`, `predict`, `predictAndUpdateState`, and `resetState` object functions are supported.
- To create a `SeriesNetwork` object for code generation, see “Load Pretrained Networks for Code Generation” (GPU Coder).

## See Also

[DAGNetwork](#) | [alexnet](#) | [analyzeNetwork](#) | [assembleNetwork](#) | [classify](#) | [darknet19](#) | [importCaffeNetwork](#) | [plot](#) | [predict](#) | [trainNetwork](#) | [trainingOptions](#) | [vgg16](#) | [vgg19](#)

### Topics

“Create Simple Deep Learning Network for Classification”  
“Train Convolutional Neural Network for Regression”  
“Sequence Classification Using Deep Learning”  
“Deep Learning in MATLAB”  
“Specify Layers of Convolutional Neural Network”  
“Define Custom Deep Learning Layers”  
“Long Short-Term Memory Networks”

### Introduced in R2016a

## setL2Factor

**Package:** `nnet.cnn.layer`

Set L2 regularization factor of layer learnable parameter

### Syntax

```
layer = setL2Factor(layer,parameterName,factor)
```

### Description

`layer = setL2Factor(layer,parameterName,factor)` sets the L2 regularization factor of the parameter with the name `parameterName` in `layer` to `factor`.

For built-in layers, you can set the L2 regularization factor directly by using the corresponding property. For example, for a `convolution2dLayer` layer, the syntax `layer = setL2Factor(layer,'Weights',factor)` is equivalent to `layer.WeightL2Factor = factor`.

### Examples

#### Set and Get L2 Regularization Factor of Learnable Parameter

Set and get the L2 regularization factor of a learnable parameter of a layer.

Define a custom PReLU layer. To create this layer, save the file `preluLayer.m` in the current folder.

Create a layer array including a custom layer `preluLayer`.

```
layers = [ ...
    imageInputLayer([28 28 1])
    convolution2dLayer(5,20)
    batchNormalizationLayer
    preluLayer(20,'prelu')
    fullyConnectedLayer(10)
    softmaxLayer
    classificationLayer];
```

Set the L2 regularization factor of the 'Alpha' learnable parameter of the `preluLayer` to 2.

```
layers(4) = setL2Factor(layers(4),'Alpha',2);
```

View the updated L2 regularization factor.

```
factor = getL2Factor(layers(4),'Alpha')
```

```
factor = 2
```

## Input Arguments

### **layer** — Input layer

scalar Layer object

Input layer, specified as a scalar Layer object.

### **parameterName** — Parameter name

character vector | string scalar

Parameter name, specified as a character vector or a string scalar.

### **factor** — L2 regularization factor

nonnegative scalar

L2 regularization factor for the parameter, specified as a nonnegative scalar.

The software multiplies this factor with the global L2 regularization factor to determine the L2 regularization factor for the specified parameter. For example, if **factor** is 2, then the L2 regularization for the specified parameter is twice the global L2 regularization factor. You can specify the global L2 regularization factor using the `trainingOptions` function.

Example: 2

## See Also

`getL2Factor` | `getLearnRateFactor` | `setLearnRateFactor` | `trainNetwork` | `trainingOptions`

## Topics

“Deep Learning in MATLAB”

“Specify Layers of Convolutional Neural Network”

“Define Custom Deep Learning Layers”

## Introduced in R2017b

# setLearnRateFactor

**Package:** nnet.cnn.layer

Set learn rate factor of layer learnable parameter

## Syntax

```
layer = setLearnRateFactor(layer,parameterName,factor)
```

## Description

`layer = setLearnRateFactor(layer,parameterName,factor)` sets the learn rate factor of the parameter with the name `parameterName` in `layer` to `factor`.

For built-in layers, you can set the learn rate factor directly by using the corresponding property. For example, for a `convolution2dLayer` layer, the syntax `layer = setLearnRateFactor(layer,'Weights',factor)` is equivalent to `layer.WeightLearnRateFactor = factor`.

## Examples

### Set and Get Learning Rate Factor of Learnable Parameter

Set and get the learning rate factor of a learnable parameter of a custom PReLU layer.

Define a custom PReLU layer. To create this layer, save the file `preluLayer.m` in the current folder.

Create a layer array including the custom layer `preluLayer`.

```
layers = [ ...
    imageInputLayer([28 28 1])
    convolution2dLayer(5,20)
    batchNormalizationLayer
    preluLayer(20,'prelu')
    fullyConnectedLayer(10)
    softmaxLayer
    classificationLayer];
```

Set the learn rate factor of the 'Alpha' learnable parameter of the `preluLayer` to 2.

```
layers(4) = setLearnRateFactor(layers(4),'Alpha',2);
```

View the updated learn rate factor.

```
factor = getLearnRateFactor(layers(4),'Alpha')
```

```
factor = 2
```

## Input Arguments

### **layer** — Input layer

scalar Layer object

Input layer, specified as a scalar Layer object.

### **parameterName** — Parameter name

character vector | string scalar

Parameter name, specified as a character vector or a string scalar.

### **factor** — Learning rate factor

nonnegative scalar

Learning rate factor for the parameter, specified as a nonnegative scalar.

The software multiplies this factor by the global learning rate to determine the learning rate for the specified parameter. For example, if `factor` is 2, then the learning rate for the specified parameter is twice the current global learning rate. The software determines the global learning rate based on the settings specified with the `trainingOptions` function.

Example: 2

## See Also

`getL2Factor` | `getLearnRateFactor` | `setL2Factor` | `trainNetwork` | `trainingOptions`

## Topics

“Deep Learning in MATLAB”

“Specify Layers of Convolutional Neural Network”

“Define Custom Deep Learning Layers”

## Introduced in R2017b

# sgdmupdate

Update parameters using stochastic gradient descent with momentum (SGDM)

## Syntax

```
[dlnet,vel] = sgdmupdate(dlnet,grad,vel)
[params,vel] = sgdmupdate(params,grad,vel)
[___] = sgdmupdate(___ learnRate,momentum)
```

## Description

Update the network learnable parameters in a custom training loop using the stochastic gradient descent with momentum (SGDM) algorithm.

---

**Note** This function applies the SGDM optimization algorithm to update network parameters in custom training loops that use networks defined as `dlnetwork` objects or model functions. If you want to train a network defined as a `Layer` array or as a `LayerGraph`, use the following functions:

- Create a `TrainingOptionsSGDM` object using the `trainingOptions` function.
  - Use the `TrainingOptionsSGDM` object with the `trainNetwork` function.
- 

`[dlnet,vel] = sgdmupdate(dlnet,grad,vel)` updates the learnable parameters of the network `dlnet` using the SGDM algorithm. Use this syntax in a training loop to iteratively update a network defined as a `dlnetwork` object.

`[params,vel] = sgdmupdate(params,grad,vel)` updates the learnable parameters in `params` using the SGDM algorithm. Use this syntax in a training loop to iteratively update the learnable parameters of a network defined using functions.

`[___] = sgdmupdate(___ learnRate,momentum)` also specifies values to use for the global learning rate and momentum, in addition to the input arguments in previous syntaxes.

## Examples

### Update Learnable Parameters Using sgdmupdate

Perform a single SGDM update step with a global learning rate of `0.05` and momentum of `0.95`.

Create the parameters and parameter gradients as numeric arrays.

```
params = rand(3,3,4);
grad = ones(3,3,4);
```

Initialize the parameter velocities for the first iteration.

```
vel = [];
```

Specify custom values for the global learning rate and momentum.

```
learnRate = 0.05;  
momentum = 0.95;
```

Update the learnable parameters using `sgdupdate`.

```
[params,vel] = sgdupdate(params,grad,vel,learnRate,momentum);
```

### **Train Network Using `sgdupdate`**

Use `sgdupdate` to train a network using the SGDM algorithm.

#### **Load Training Data**

Load the digits training data.

```
[XTrain,YTrain] = digitTrain4DArrayData;  
classes = categories(YTrain);  
numClasses = numel(classes);
```

#### **Define Network**

Define the network architecture and specify the average image value using the 'Mean' option in the image input layer.

```
layers = [  
    imageInputLayer([28 28 1], 'Name','input','Mean',mean(XTrain,4))  
    convolution2dLayer(5,20,'Name','conv1')  
    reluLayer('Name','relu1')  
    convolution2dLayer(3,20,'Padding',1,'Name','conv2')  
    reluLayer('Name','relu2')  
    convolution2dLayer(3,20,'Padding',1,'Name','conv3')  
    reluLayer('Name','relu3')  
    fullyConnectedLayer(numClasses,'Name','fc')];  
lgraph = layerGraph(layers);
```

Create a `dlnetwork` object from the layer graph.

```
dlnet = dlnetwork(lgraph);
```

#### **Define Model Gradients Function**

Create the helper function `modelGradients`, listed at the end of the example. The function takes a `dlnetwork` object `dlnet` and a mini-batch of input data `dX` with corresponding labels `Y`, and returns the loss and the gradients of the loss with respect to the learnable parameters in `dlnet`.

#### **Specify Training Options**

Specify the options to use during training.

```
miniBatchSize = 128;  
numEpochs = 20;  
numObservations = numel(YTrain);  
numIterationsPerEpoch = floor(numObservations./miniBatchSize);
```



Train on a GPU, if one is available. Using a GPU requires Parallel Computing Toolbox™ and a CUDA® enabled NVIDIA® GPU with compute capability 3.0 or higher.

```
executionEnvironment = "auto";
```

Initialize the velocity parameter.

```
vel = [];
```

Initialize the training progress plot.

```
plots = "training-progress";
if plots == "training-progress"
    iteration = 1;
    figure
    lineLossTrain = animatedline;
    xlabel("Total Iterations")
    ylabel("Loss")
end
```

### Train Network

Train the model using a custom training loop. For each epoch, shuffle the data and loop over mini-batches of data. Update the network parameters using the `sgdmupdate` function. At the end of each epoch, display the training progress.

```
for epoch = 1:numEpochs
    % Shuffle data.
    idx = randperm(numel(YTrain));
    XTrain = XTrain(:,:, :,idx);
    YTrain = YTrain(idx);

    for i = 1:numIterationsPerEpoch

        % Read mini-batch of data and convert the labels to dummy
        % variables.
        idx = (i-1)*miniBatchSize+1:i*miniBatchSize;
        X = XTrain(:,:, :,idx);

        Y = zeros(numClasses, miniBatchSize, 'single');
        for c = 1:numClasses
            Y(c,YTrain(idx)==classes(c)) = 1;
        end

        % Convert mini-batch of data to a darray.
        dlX = darray(single(X), 'SSCB');

        % If training on a GPU, then convert data to a gpuArray.
        if (executionEnvironment == "auto" && canUseGPU) || executionEnvironment == "gpu"
            dlX = gpuArray(dlX);
        end

        % Evaluate the model gradients and loss using dlfeval and the
        % modelGradients helper function.
        [grad,loss] = dlfeval(@modelGradients,dlnet,dlX,Y);

        % Update the network parameters using the SGDM optimizer.
        [dlnet,vel] = sgdmupdate(dlnet,grad,vel);
    end
end
```

```

% Display the training progress.
if plots == "training-progress"
    addpoints(lineLossTrain,iteration,double(gather(extractdata(loss))))
    title("Loss During Training: Epoch - " + epoch + "; Iteration - " + i)
    drawnow
    iteration = iteration + 1;
end
end
end
end

```

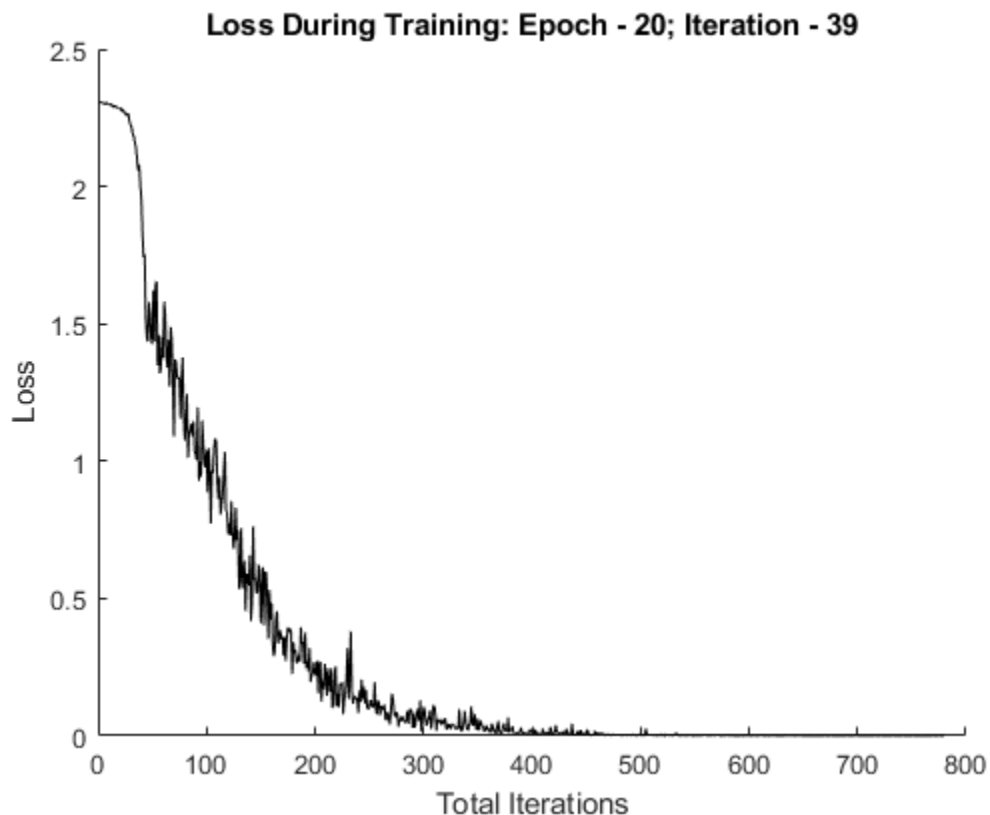

### Test the Network

Test the classification accuracy of the model by comparing the predictions on a test set with the true labels.

```
[XTest, YTest] = digitTest4DArrayData;
```

Convert the data to a `darray` with the dimension format 'SSCB'. For GPU prediction, also convert the data to a `gpuArray`.

```

dLXTest = darray(XTest, 'SSCB');
if (executionEnvironment == "auto" && canUseGPU) || executionEnvironment == "gpu"
    dLXTest = gpuArray(dLXTest);
end

```

To classify images using a `dlnetwork` object, use the `predict` function and find the classes with the highest scores.

```
dLYPred = predict(dlnet,dLXTest);
[~,idx] = max(extractdata(dLYPred),[],1);
YPred = classes(idx);
```

Evaluate the classification accuracy.

```
accuracy = mean(YPred==YTest)
```

```
accuracy = 0.9914
```

### Model Gradients Function

The `modelGradients` helper function takes a `dlnetwork` object `dlnet` and a mini-batch of input data `dLX` with corresponding labels `Y`, and returns the loss and the gradients of the loss with respect to the learnable parameters in `dlnet`. To compute the gradients automatically, use the `dlgradient` function.

```
function [gradients,loss] = modelGradients(dlnet,dLX,Y)

    dLYPred = forward(dlnet,dLX);
    dLYPred = softmax(dLYPred);

    loss = crossentropy(dLYPred,Y);
    gradients = dlgradient(loss,dlnet.Learnables);

end
```

## Input Arguments

### `dlnet` — Network

`dlnetwork` object

Network, specified as a `dlnetwork` object.

The function updates the `dlnet.Learnables` property of the `dlnetwork` object. `dlnet.Learnables` is a table with three variables:

- `Layer` — Layer name, specified as a string scalar.
- `Parameter` — Parameter name, specified as a string scalar.
- `Value` — Value of parameter, specified as a cell array containing a `dlarray`.

The input argument `grad` must be a table of the same form as `dlnet.Learnables`.

### `params` — Network learnable parameters

`dlarray` | numeric array | cell array | structure | table

Network learnable parameters, specified as a `dlarray`, a numeric array, a cell array, a structure, or a table.

If you specify `params` as a table, it must contain the following three variables.

- `Layer` — Layer name, specified as a string scalar.
- `Parameter` — Parameter name, specified as a string scalar.
- `Value` — Value of parameter, specified as a cell array containing a `dlarray`.

You can specify `params` as a container of learnable parameters for your network using a cell array, structure, or table, or nested cell arrays or structures. The learnable parameters inside the cell array, structure, or table must be `dlnarray` or numeric values of data type `double` or `single`.

The input argument `grad` must be provided with exactly the same data type, ordering, and fields (for structures) or variables (for tables) as `params`.

Data Types: `single` | `double` | `struct` | `table` | `cell`

**grad — Gradients of the loss**

`dlnarray` | numeric array | cell array | structure | table

Gradients of the loss, specified as a `dlnarray`, a numeric array, a cell array, a structure, or a table.

The exact form of `grad` depends on the input network or learnable parameters. The following table shows the required format for `grad` for possible inputs to `sgdmupdate`.

Input	Learnable Parameters	Gradients
<code>dlnet</code>	Table <code>dlnet.Learnables</code> containing <code>Layer</code> , <code>Parameter</code> , and <code>Value</code> variables. The <code>Value</code> variable consists of cell arrays that contain each learnable parameter as a <code>dlnarray</code> .	Table with the same data type, variables, and ordering as <code>dlnet.Learnables</code> . <code>grad</code> must have a <code>Value</code> variable consisting of cell arrays that contain the gradient of each learnable parameter.
<code>params</code>	<code>dlnarray</code>	<code>dlnarray</code> with the same data type and ordering as <code>params</code>
	Numeric array	Numeric array with the same data type and ordering as <code>params</code>
	Cell array	Cell array with the same data types, structure, and ordering as <code>params</code>
	Structure	Structure with the same data types, fields, and ordering as <code>params</code>
	Table with <code>Layer</code> , <code>Parameter</code> , and <code>Value</code> variables. The <code>Value</code> variable must consist of cell arrays that contain each learnable parameter as a <code>dlnarray</code> .	Table with the same data types, variables, and ordering as <code>params</code> . <code>grad</code> must have a <code>Value</code> variable consisting of cell arrays that contain the gradient of each learnable parameter.

You can obtain `grad` from a call to `dlfeval` that evaluates a function that contains a call to `dlgradient`. For more information, see “Use Automatic Differentiation In Deep Learning Toolbox”.

**vel — Parameter velocities**

`[]` | `dlnarray` | numeric array | cell array | structure | table

Parameter velocities, specified as an empty array, a `dlnarray`, a numeric array, a cell array, a structure, or a table.

The exact form of `vel` depends on the input network or learnable parameters. The following table shows the required format for `vel` for possible inputs to `sgdmupdate`.

Input	Learnable Parameters	Velocities
<code>dlnet</code>	Table <code>dlnet.Learnables</code> containing <code>Layer</code> , <code>Parameter</code> , and <code>Value</code> variables. The <code>Value</code> variable consists of cell arrays that contain each learnable parameter as a <code>dlarray</code> .	Table with the same data type, variables, and ordering as <code>dlnet.Learnables</code> . <code>vel</code> must have a <code>Value</code> variable consisting of cell arrays that contain the velocity of each learnable parameter.
<code>params</code>	<code>dlarray</code>	<code>dlarray</code> with the same data type and ordering as <code>params</code>
	Numeric array	Numeric array with the same data type and ordering as <code>params</code>
	Cell array	Cell array with the same data types, structure, and ordering as <code>params</code>
	Structure	Structure with the same data types, fields, and ordering as <code>params</code>
	Table with <code>Layer</code> , <code>Parameter</code> , and <code>Value</code> variables. The <code>Value</code> variable must consist of cell arrays that contain each learnable parameter as a <code>dlarray</code> .	Table with the same data types, variables, and ordering as <code>params</code> . <code>vel</code> must have a <code>Value</code> variable consisting of cell arrays that contain the velocity of each learnable parameter.

If you specify `vel` as an empty array, the function assumes no previous velocities and runs in the same way as for the first update in a series of iterations. To update the learnable parameters iteratively, use the `vel` output of a previous call to `sgdmupdate` as the `vel` input.

### LearnRate — Global learning rate

0.01 (default) | positive scalar

Learning rate, specified as a positive scalar. The default value of `LearnRate` is 0.01.

If you specify the network parameters as a `dlnetwork` object, the learning rate for each parameter is the global learning rate multiplied by the corresponding learning rate factor property defined in the network layers.

### momentum — Momentum

0.9 (default) | positive scalar between 0 and 1

Momentum, specified as a positive scalar between 0 and 1. The default value of `momentum` is 0.9.

## Output Arguments

### `dlnet` — Updated network

`dlnetwork` object

Network, returned as a `dlnetwork` object.

The function updates the `dlnet.Learnables` property of the `dlnetwork` object.

**params — Updated network learnable parameters**

`dlarray` | numeric array | cell array | structure | table

Updated network learnable parameters, returned as a `dlarray`, a numeric array, a cell array, a structure, or a table with a `Value` variable containing the updated learnable parameters of the network.

**vel — Updated parameter velocities**

`dlarray` | numeric array | cell array | structure | table

Updated parameter velocities, returned as a `dlarray`, a numeric array, a cell array, a structure, or a table.

## More About

### Stochastic Gradient Descent with Momentum

The function uses the stochastic gradient descent with momentum algorithm to update the learnable parameters. For more information, see the definition of the stochastic gradient descent with momentum algorithm under “Stochastic Gradient Descent” on page 1-800 on the `trainingOptions` reference page.

## Extended Capabilities

### GPU Arrays

Accelerate code by running on a graphics processing unit (GPU) using Parallel Computing Toolbox™.

Usage notes and limitations:

- When at least one of the following input arguments is a `gpuArray` or a `dlarray` with underlying data of type `gpuArray`, this function runs on the GPU.
  - `grad`
  - `params`

For more information, see “Run MATLAB Functions on a GPU” (Parallel Computing Toolbox).

## See Also

`adamupdate` | `dlarray` | `dlfeval` | `dlgradient` | `dlnetwork` | `dlupdate` | `forward` | `rmspropupdate`

### Topics

“Define Custom Training Loops, Loss Functions, and Networks”

“Specify Training Options in Custom Training Loop”

“Train Network Using Custom Training Loop”

### Introduced in R2019b

# shuffle

Shuffle data in `augmentedImageDatastore`

## Syntax

```
auimds2 = shuffle(auimds)
```

## Description

`auimds2 = shuffle(auimds)` returns an `augmentedImageDatastore` object containing a random ordering of the data from augmented image datastore `auimds`.

## Input Arguments

### **auimds** — Augmented image datastore

`augmentedImageDatastore`

Augmented image datastore, specified as an `augmentedImageDatastore` object.

## Output Arguments

### **auimds2** — Output datastore

`augmentedImageDatastore` object

Output datastore, returned as an `augmentedImageDatastore` object containing randomly ordered files from `auimds`.

## See Also

`read` | `readByIndex` | `readall`

**Introduced in R2018a**

## shufflenet

Pretrained ShuffleNet convolutional neural network

### Syntax

```
net = shufflenet
```

### Description

ShuffleNet is a convolutional neural network that is trained on more than a million images from the ImageNet database [1]. The network can classify images into 1000 object categories, such as keyboard, mouse, pencil, and many animals. As a result, the network has learned rich feature representations for a wide range of images. The network has an image input size of 224-by-224. For more pretrained networks in MATLAB, see “Pretrained Deep Neural Networks”.

You can use `classify` to classify new images using the ShuffleNet model. Follow the steps of “Classify Image Using GoogLeNet” and replace GoogLeNet with ShuffleNet.

To retrain the network on a new classification task, follow the steps of “Train Deep Learning Network to Classify New Images” and load ShuffleNet instead of GoogLeNet.

`net = shufflenet` returns a pretrained ShuffleNet convolutional neural network.

This function requires the *Deep Learning Toolbox Model for ShuffleNet Network* support package. If this support package is not installed, then the function provides a download link.

### Examples

#### Download ShuffleNet Support Package

Download and install the *Deep Learning Toolbox Model for ShuffleNet Network* support package.

Type `shufflenet` at the command line.

```
shufflenet
```

If the *Deep Learning Toolbox Model for ShuffleNet Network* support package is not installed, then the function provides a link to the required support package in the Add-On Explorer. To install the support package, click the link, and then click **Install**. Check that the installation is successful by typing `shufflenet` at the command line. If the required support package is installed, then the function returns a DAGNetwork object.

```
shufflenet
```

```
ans =
```

```
    DAGNetwork with properties:
```



```
Layers: [173x1 nnet.cnn.layer.Layer]  
Connections: [188x2 table]
```

## Transfer Learning with ShuffleNet

You can use transfer learning to retrain the network to classify a new set of images.

Open the example “Train Deep Learning Network to Classify New Images”. The original example uses the GoogLeNet pretrained network. To perform transfer learning using a different network, load your desired pretrained network and follow the steps in the example.

Load the ShuffleNet network instead of GoogLeNet.

```
net = shufflenet
```

Follow the remaining steps in the example to retrain your network. You must replace the last learnable layer and the classification layer in your network with new layers for training. The example shows you how to find which layers to replace.

## Output Arguments

### **net** — Pretrained ShuffleNet convolutional neural network

DAGNetwork object

Pretrained ShuffleNet convolutional neural network, returned as a DAGNetwork object.

## References

[1] *ImageNet*. <http://www.image-net.org>

[2] Zhang, Xiangyu, Xinyu Zhou, Mengxiao Lin, and Jian Sun. "ShuffleNet: An Extremely Efficient Convolutional Neural Network for Mobile Devices." *arXiv preprint arXiv:1707.01083v2* (2017).

## See Also

DAGNetwork | densenet201 | googlenet | inceptionresnetv2 | layerGraph | nasnetlarge | nasnetmobile | plot | resnet101 | resnet50 | squeezenet | trainNetwork | vgg16 | vgg19

## Topics

“Deep Learning in MATLAB”

“Pretrained Deep Neural Networks”

“Classify Image Using GoogLeNet”

“Train Deep Learning Network to Classify New Images”

“Train Residual Network for Image Classification”

## Introduced in R2019a

## sigmoid

Apply sigmoid activation

### Syntax

```
dLY = sigmoid(dLX)
```

### Description

The sigmoid activation operation applies the sigmoid function to the input data.

This operation is equivalent to

$$f(x) = \frac{1}{1 + e^{-x}}$$

`dLY = sigmoid(dLX)` computes the sigmoid activation of the input `dLX` by applying the sigmoid transfer function. All values in `dLY` are between 0 and 1.

### Examples

#### Apply Sigmoid Activation

Use the `sigmoid` function to set all values in the input data to a value between 0 and 1.

Create the input data as a single observation of random values with a height and width of seven and 32 channels.

```
height = 7;  
width = 7;  
channels = 32;  
observations = 1;  
  
X = randn(height,width,channels,observations);  
dLX = dLarray(X, 'SSCB');
```

Compute the sigmoid activation.

```
dLY = sigmoid(dLX);
```

All values in `dLY` now range between 0 and 1.

### Input Arguments

#### dLX — Input data

`dLarray`

Input data, specified as a `dLarray` with or without dimension labels.

Data Types: `single` | `double`

## Output Arguments

### **dLY — Sigmoid activations**

`dLarray`

Sigmoid activations, returned as a `dLarray`. All values in `dLY` are between 0 and 1. The output `dLY` has the same underlying data type as the input `dLX`.

If the input data `dLX` is a formatted `dLarray`, `dLY` has the same dimension labels as `dLX`. If the input data is not a formatted `dLarray`, `dLY` is an unformatted `dLarray` with the same dimension order as the input data.

## Extended Capabilities

### **GPU Arrays**

Accelerate code by running on a graphics processing unit (GPU) using Parallel Computing Toolbox™.

Usage notes and limitations:

- When the input argument `dLX` is a `dLarray` with underlying data of type `gpuArray`, this function runs on the GPU.

For more information, see “Run MATLAB Functions on a GPU” (Parallel Computing Toolbox).

## See Also

`batchnorm` | `dLarray` | `dLfeval` | `dLgradient` | `leakyrelu` | `relu`

### **Topics**

“Define Custom Training Loops, Loss Functions, and Networks”

“Train Network Using Model Function”

### **Introduced in R2019b**

## softmax

Apply softmax activation to channel dimension

### Syntax

```
dLY = softmax(dLX)
dLY = softmax(dLX, 'DataFormat', FMT)
```

### Description

The softmax activation operation applies the softmax function to the channel dimension of the input data.

The softmax function normalizes the value of the input data across the channel dimension such that it sums to one. You can regard the output of the softmax function as a probability distribution.

---

**Note** This function applies the softmax operation to `dLarray` data. If you want to apply softmax within a `layerGraph` object or `Layer` array, use the following layer:

- `softmaxLayer`
- 

`dLY = softmax(dLX)` computes the softmax activation of the input `dLX` by applying the softmax transfer function to the channel dimension of the input data. All values in `dLY` are between 0 and 1, and sum to 1. The input `dLX` is a formatted `dLarray` with dimension labels. The output `dLY` is a formatted `dLarray` with the same dimension labels as `dLX`.

`dLY = softmax(dLX, 'DataFormat', FMT)` also specifies dimension format `FMT` when `dLX` is not a formatted `dLarray`. The output `dLY` is an unformatted `dLarray` with the same dimension order as `dLX`.

### Examples

#### Apply Softmax Activation

Use the `softmax` function to set all values in the input data to values between 0 and 1 that sum to 1 over all channels.

Create the input classification data as two observations of random variables. The data can be in any of 10 categories.

```
numCategories = 10;
observations = 2;

X = rand(numCategories, observations);
dLX = dLarray(X, 'CB');
```

Compute the `softmax` activation.

```

dLY = softmax(dLX);
totalProb = sum(dLY,1)

dLY =

    10(C) x 2(B) dlarray

    0.1151    0.0578
    0.1261    0.1303
    0.0579    0.1285
    0.1270    0.0802
    0.0959    0.1099
    0.0562    0.0569
    0.0673    0.0753
    0.0880    0.1233
    0.1328    0.1090
    0.1337    0.1288
totalProb =

    1(C) x 2(B) dlarray

    1.0000    1.0000

```

All values in `dLY` range between 0 and 1. The values over all channels sum to 1 for each observation.

## Input Arguments

### **dLX** — Input data

`dlarray`

Input data, specified as a `dlarray` with or without dimension labels. When `dLX` is not a formatted `dlarray`, you must specify the dimension label format using `'DataFormat', FMT`.

`dLX` must contain a `'C'` channel dimension.

Data Types: `single` | `double`

### **FMT** — Dimension order of unformatted data

`char array` | `string`

Dimension order of unformatted input data, specified as the comma-separated pair consisting of `'DataFormat'` and a character array or string `FMT` that provides a label for each dimension of the data. Each character in `FMT` must be one of the following:

- `'S'` — Spatial
- `'C'` — Channel
- `'B'` — Batch (for example, samples and observations)
- `'T'` — Time (for example, sequences)
- `'U'` — Unspecified

You can specify multiple dimensions labeled `'S'` or `'U'`. You can use the labels `'C'`, `'B'`, and `'T'` at most once.

You must specify `'DataFormat', FMT` when the input data `dLX` is not a formatted `dlarray`.

Example: `'DataFormat', 'SSCB'`

Data Types: `char` | `string`

## Output Arguments

### **dLY — Softmax activations**

`dLarray`

Softmax activations, returned as a `dLarray`. All values in `dLY` are between 0 and 1. The output `dLY` has the same underlying data type as the input `dLX`.

If the input data `dLX` is a formatted `dLarray`, `dLY` has the same dimension labels as `dLX`. If the input data is not a formatted `dLarray`, `dLY` is an unformatted `dLarray` with the same dimension order as the input data.

## More About

### **Softmax Activation**

The `softmax` function normalizes the input across the channel dimension, such that it sums to one. For more information, see the definition of “Softmax Layer” on page 1-742 on the `softmaxLayer` reference page.

## Extended Capabilities

### **GPU Arrays**

Accelerate code by running on a graphics processing unit (GPU) using Parallel Computing Toolbox™.

Usage notes and limitations:

- When the input argument `dLX` is a `dLarray` with underlying data of type `gpuArray`, this function runs on the GPU.

For more information, see “Run MATLAB Functions on a GPU” (Parallel Computing Toolbox).

## See Also

`batchnorm` | `crossentropy` | `dLarray` | `dLfeval` | `dLgradient` | `fullyconnect` | `relu`

### **Topics**

“Define Custom Training Loops, Loss Functions, and Networks”

“Train Network Using Model Function”

“Make Predictions Using Model Function”

“Train Network with Multiple Outputs”

### **Introduced in R2019b**

# softmaxLayer

Softmax layer

## Description

A softmax layer applies a softmax function to the input.

## Creation

### Syntax

```
layer = softmaxLayer  
layer = softmaxLayer('Name',Name)
```

### Description

`layer = softmaxLayer` creates a softmax layer.

`layer = softmaxLayer('Name',Name)` creates a softmax layer and sets the optional `Name` property using a name-value pair. For example, `softmaxLayer('Name','sm1')` creates a softmax layer with the name 'sm1'. Enclose the property name in single quotes.

## Properties

### Name — Layer name

`''` (default) | character vector | string scalar

Layer name, specified as a character vector or a string scalar. To include a layer in a layer graph, you must specify a nonempty unique layer name. If you train a series network with the layer and `Name` is set to `''`, then the software automatically assigns a name to the layer at training time.

Data Types: `char` | `string`

### NumInputs — Number of inputs

1 (default)

Number of inputs of the layer. This layer accepts a single input only.

Data Types: `double`

### InputNames — Input names

`{'in'}` (default)

Input names of the layer. This layer accepts a single input only.

Data Types: `cell`

### NumOutputs — Number of outputs

1 (default)

Number of outputs of the layer. This layer has a single output only.

Data Types: double

### OutputNames — Output names

{ 'out' } (default)

Output names of the layer. This layer has a single output only.

Data Types: cell

## Examples

### Create Softmax Layer

Create a softmax layer with the name 'sm1'.

```
layer = softmaxLayer('Name','sm1')
```

```
layer =  
    SoftmaxLayer with properties:
```

```
    Name: 'sm1'
```

Include a softmax layer in a Layer array.

```
layers = [ ...  
    imageInputLayer([28 28 1])  
    convolution2dLayer(5,20)  
    reluLayer  
    maxPooling2dLayer(2,'Stride',2)  
    fullyConnectedLayer(10)  
    softmaxLayer  
    classificationLayer]
```

```
layers =  
    7x1 Layer array with layers:
```

1	''	Image Input	28x28x1 images with 'zerocenter' normalization
2	''	Convolution	20 5x5 convolutions with stride [1 1] and padding [0 0 0 0]
3	''	ReLU	ReLU
4	''	Max Pooling	2x2 max pooling with stride [2 2] and padding [0 0 0 0]
5	''	Fully Connected	10 fully connected layer
6	''	Softmax	softmax
7	''	Classification Output	crossentropyex

## More About

### Softmax Layer

A softmax layer applies a softmax function to the input.

For classification problems, a softmax layer and then a classification layer must follow the final fully connected layer.



The output unit activation function is the softmax function:

$$y_r(x) = \frac{\exp(a_r(x))}{\sum_{j=1}^k \exp(a_j(x))},$$

where  $0 \leq y_r \leq 1$  and  $\sum_{j=1}^k y_j = 1$ .

The softmax function is the output unit activation function after the last fully connected layer for multi-class classification problems:

$$P(c_r|x, \theta) = \frac{P(x, \theta|c_r)P(c_r)}{\sum_{j=1}^k P(x, \theta|c_j)P(c_j)} = \frac{\exp(a_r(x, \theta))}{\sum_{j=1}^k \exp(a_j(x, \theta))},$$

where  $0 \leq P(c_r|x, \theta) \leq 1$  and  $\sum_{j=1}^k P(c_j|x, \theta) = 1$ . Moreover,  $a_r = \ln(P(x, \theta|c_r)P(c_r))$ ,  $P(x, \theta|c_r)$  is the conditional probability of the sample given class  $r$ , and  $P(c_r)$  is the class prior probability.

The softmax function is also known as the *normalized exponential* and can be considered the multi-class generalization of the logistic sigmoid function [1].

## References

[1] Bishop, C. M. *Pattern Recognition and Machine Learning*. Springer, New York, NY, 2006.

## Extended Capabilities

### GPU Code Generation

Generate CUDA® code for NVIDIA® GPUs using GPU Coder™.

## See Also

`classificationLayer` | `convolution2dLayer` | `fullyConnectedLayer` | `trainNetwork`

### Topics

“Create Simple Deep Learning Network for Classification”

“Train Convolutional Neural Network for Regression”

“Deep Learning in MATLAB”

“Specify Layers of Convolutional Neural Network”

“List of Deep Learning Layers”

### Introduced in R2016a

## sortClasses

**Package:** `mlearnlib.graphics.chart`

Sort classes of confusion matrix chart

### Syntax

```
sortClasses(cm,order)
```

### Description

`sortClasses(cm,order)` sorts the classes of the confusion matrix chart `cm` in the order specified by `order`. You can sort the classes in their natural order, by the values along the diagonal of the confusion matrix, or in fixed order that you specify.

### Examples

#### Sort Classes in a Fixed Order

Load a sample of predicted and true labels for a classification problem. `trueLabels` are the true labels for an image classification problem and `predictedLabels` are the predictions of a convolutional neural network. Create a confusion matrix chart.

```
load('Cifar10Labels.mat','trueLabels','predictedLabels');  
figure  
cm = confusionchart(trueLabels,predictedLabels);
```

True Class	airplane	923	4	21	8	4	1	5	5	23	6
	automobile	5	972	2					1	5	15
	bird	26	2	892	30	13	8	17	5	4	3
	cat	12	4	32	826	24	48	30	12	5	7
	deer	5	1	28	24	898	13	14	14	2	1
	dog	7	2	28	111	18	801	13	17		3
	frog	5		16	27	3	4	943	1	1	
	horse	9	1	14	13	22	17	3	915	2	4
	ship	37	10	4	4		1	2	1	931	10
	truck	20	39	3	3			2	1	9	923
		airplane	automobile	bird	cat	deer	dog	frog	horse	ship	truck
		Predicted Class									

Reorder the classes of the confusion matrix chart so that the classes are in a fixed order.

```
sortClasses(cm, ...
  ["cat" "dog" "horse" "deer" "bird" "frog", ...
  "airplane" "ship" "automobile" "truck"])
```

	cat	dog	horse	deer	bird	frog	airplane	ship	automobile	truck
True Class	cat	dog	horse	deer	bird	frog	airplane	ship	automobile	truck
	826	48	12	24	32	30	12	5	4	7
	111	801	17	18	28	13	7		2	3
	13	17	915	22	14	3	9	2	1	4
	24	13	14	898	28	14	5	2	1	1
	30	8	5	13	892	17	26	4	2	3
	27	4	1	3	16	943	5	1		
	8	1	5	4	21	5	923	23	4	6
	4	1	1		4	2	37	931	10	10
			1		2		5	5	972	15
	3		1		3	2	20	9	39	923
	cat	dog	horse	deer	bird	frog	airplane	ship	automobile	truck
	Predicted Class									

### Sort Classes by Precision or Recall

Load a sample of predicted and true labels for a classification problem. `trueLabels` are the true labels for an image classification problem and `predictedLabels` are the predictions of a convolutional neural network. Create a confusion matrix chart with column and row summaries

```
load('Cifar10Labels.mat','trueLabels','predictedLabels');
figure
cm = confusionchart(trueLabels,predictedLabels, ...
    'ColumnSummary','column-normalized', ...
    'RowSummary','row-normalized');
```

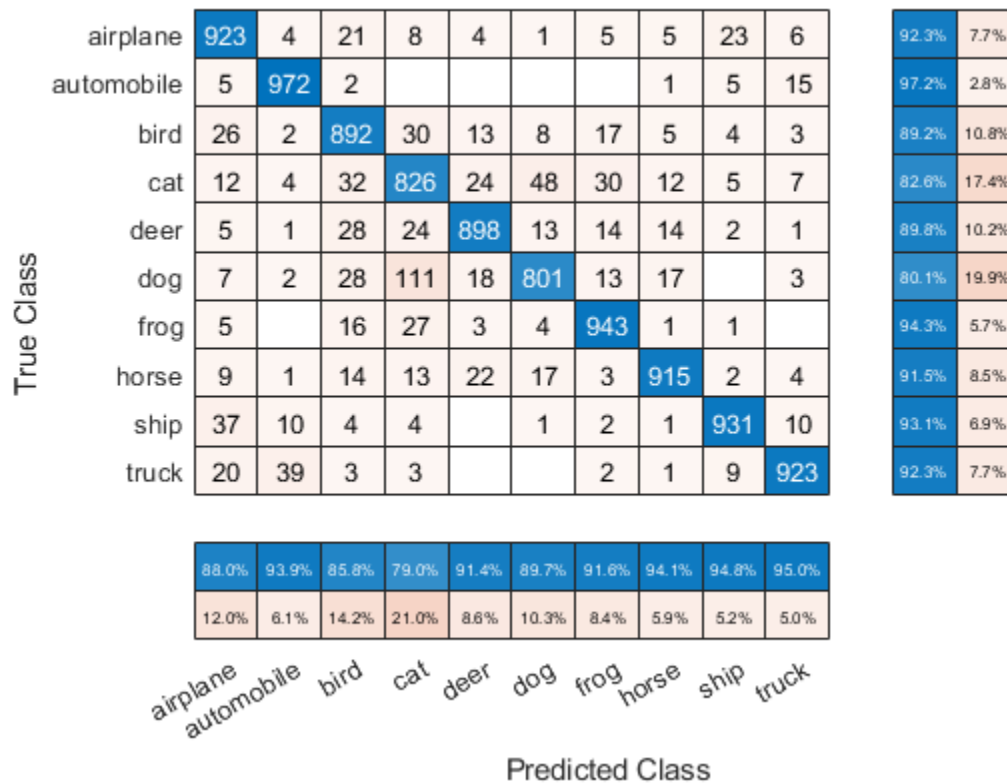

To sort the classes of the confusion matrix by class-wise recall (true positive rate), normalize the cell values across each row, that is, by the number of observations that have the same true class. Sort the classes by the corresponding diagonal cell values and reset the normalization of the cell values. The classes are now sorted such that the percentages in the blue cells in the row summaries to the right are decreasing.

```

cm.Normalization = 'row-normalized';
sortClasses(cm, 'descending-diagonal');
cm.Normalization = 'absolute';
  
```

True Class	automobile	972		5	5	15	1		2			97.2%	2.8%
	frog		943	1	5		1	3	16	27	4	94.3%	5.7%
	ship	10	2	931	37	10	1		4	4	1	93.1%	6.9%
	airplane	4	5	23	923	6	5	4	21	8	1	92.3%	7.7%
	truck	39	2	9	20	923	1		3	3		92.3%	7.7%
	horse	1	3	2	9	4	915	22	14	13	17	91.5%	8.5%
	deer	1	14	2	5	1	14	898	28	24	13	89.8%	10.2%
	bird	2	17	4	26	3	5	13	892	30	8	89.2%	10.8%
	cat	4	30	5	12	7	12	24	32	826	48	82.6%	17.4%
	dog	2	13		7	3	17	18	28	111	801	80.1%	19.9%

  

93.9%	91.6%	94.8%	88.0%	95.0%	94.1%	91.4%	85.8%	79.0%	89.7%
6.1%	8.4%	5.2%	12.0%	5.0%	5.9%	8.6%	14.2%	21.0%	10.3%
automobile	frog	ship	airplane	truck	horse	deer	bird	cat	dog

Predicted Class

To sort the classes by class-wise precision (positive predictive value), normalize the cell values across each column, that is, by the number of observations that have the same predicted class. Sort the classes by the corresponding diagonal cell values and reset the normalization of the cell values. The classes are now sorted such that the percentages in the blue cells in the column summaries at the bottom are decreasing.

```
cm.Normalization = 'column-normalized';
sortClasses(cm, 'descending-diagonal');
cm.Normalization = 'absolute';
```

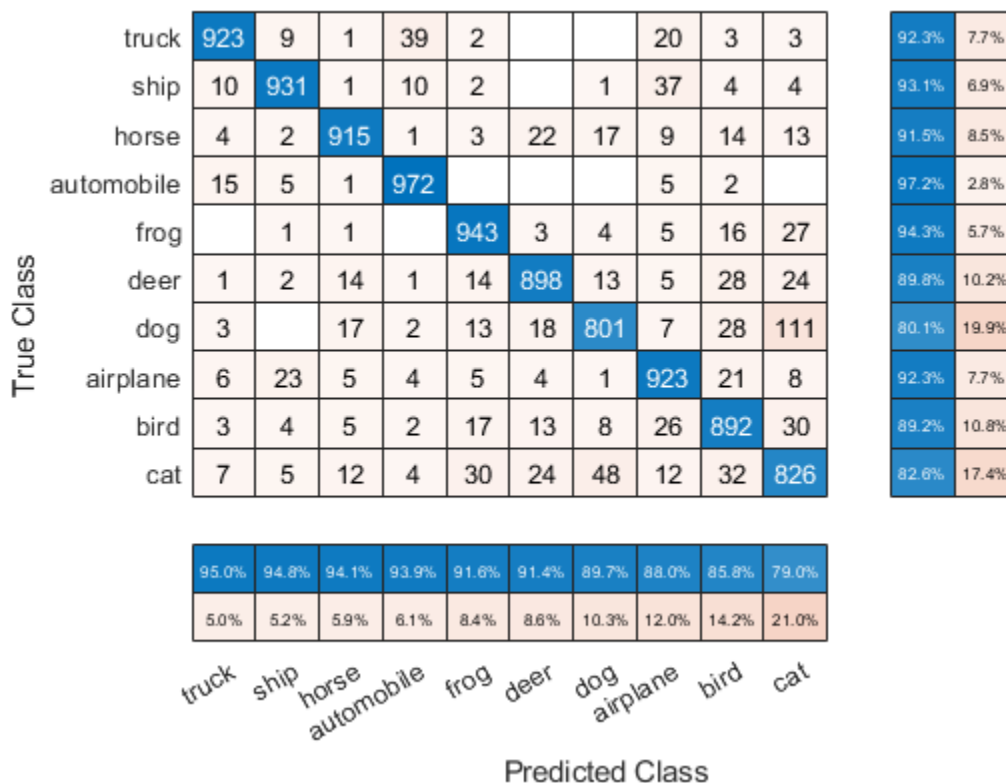

## Input Arguments

### cm – Confusion matrix chart

ConfusionMatrixChart object

Confusion matrix chart, specified as a ConfusionMatrixChart object. To create a confusion matrix chart, use confusionchart,

### order – Order in which to sort classes

'auto' | 'ascending-diagonal' | 'descending-diagonal' | array

Order in which to sort the classes of the confusion matrix chart, specified as one of these values:

- 'auto' — Sorts the classes into their natural order as defined by the sort function. For example, if the class labels of the confusion matrix chart are a string vector, then sort alphabetically. If the class labels are an ordinal categorical vector, then use the order of the class labels.
- 'ascending-diagonal' — Sort the classes so that the values along the diagonal of the confusion matrix increase from top left to bottom right.
- 'descending-diagonal' — Sort the classes so that the values along the diagonal of the confusion matrix decrease from top left to bottom right.
- 'cluster' (Requires Statistics and Machine Learning Toolbox) — Sort the classes to cluster similar classes. You can customize clustering by using the pdist, linkage, and optimalleaforder functions. For details, see “Sort Classes to Cluster Similar Classes” (Statistics and Machine Learning Toolbox).

- **Array** — Sort the classes in a unique order specified by a categorical vector, numeric vector, string vector, character array, cell array of character vectors, or logical vector. The array must be a permutation of the `ClassLabels` property of the confusion matrix chart.

Example: `sortClasses(cm, 'ascending-diagonal')`

Example: `sortClasses(cm, ["owl", "cat", "toad"])`

## See Also

### Functions

`categorical` | `confusionchart`

### Properties

`ConfusionMatrixChart` Properties

### Topics

“Deep Learning in MATLAB”

**Introduced in R2018b**



# squeezeNet

SqueezeNet convolutional neural network

## Syntax

```
net = squeezeNet
net = squeezeNet('Weights','imagenet')
```

```
lgraph = squeezeNet('Weights','none')
```

## Description

SqueezeNet is a convolutional neural network that is 18 layers deep. You can load a pretrained version of the network trained on more than a million images from the ImageNet database [1]. The pretrained network can classify images into 1000 object categories, such as keyboard, mouse, pencil, and many animals. As a result, the network has learned rich feature representations for a wide range of images. This function returns a SqueezeNet v1.1 network, which has similar accuracy to SqueezeNet v1.0 but requires fewer floating-point operations per prediction [3]. The network has an image input size of 227-by-227. For more pretrained networks in MATLAB, see “Pretrained Deep Neural Networks”.

You can use `classify` to classify new images using the SqueezeNet network. For an example, see “Classify Image Using SqueezeNet” on page 1-769.

You can retrain a SqueezeNet network to perform a new task using transfer learning. For an example, see “Interactive Transfer Learning Using SqueezeNet” on page 1-752.

`net = squeezeNet` returns a SqueezeNet network trained on the ImageNet data set.

`net = squeezeNet('Weights','imagenet')` returns a SqueezeNet network trained on the ImageNet data set. This syntax is equivalent to `net = squeezeNet`.

`lgraph = squeezeNet('Weights','none')` returns the untrained SqueezeNet network architecture.

## Examples

### Load SqueezeNet Network

Load a pretrained SqueezeNet network.

```
net = squeezeNet
```

```
net =
```

```
DAGNetwork with properties:
```

```
    Layers: [68x1 nnet.cnn.layer.Layer]
Connections: [75x2 table]
```

This function returns a `DAGNetwork` object.

SqueezeNet is included within Deep Learning Toolbox. To load other networks, use functions such as `googlenet` to get links to download pretrained networks from the Add-On Explorer.

## Interactive Transfer Learning Using SqueezeNet

This example shows how to fine-tune a pretrained SqueezeNet network to classify a new collection of images. This process is called transfer learning and is usually much faster and easier than training a new network, because you can apply learned features to a new task using a smaller number of training images. To prepare a network for transfer learning interactively, use Deep Network Designer.

### Extract Data

In the workspace, extract the MathWorks Merch data set. This is a small data set containing 75 images of MathWorks merchandise, belonging to five different classes (*cap*, *cube*, *playing cards*, *screwdriver*, and *torch*).

```
unzip("MerchData.zip");
```

### Open SqueezeNet in Deep Network Designer

Open Deep Network Designer.

```
deepNetworkDesigner
```

Select **SqueezeNet** from the list of pretrained networks and click **Open**.

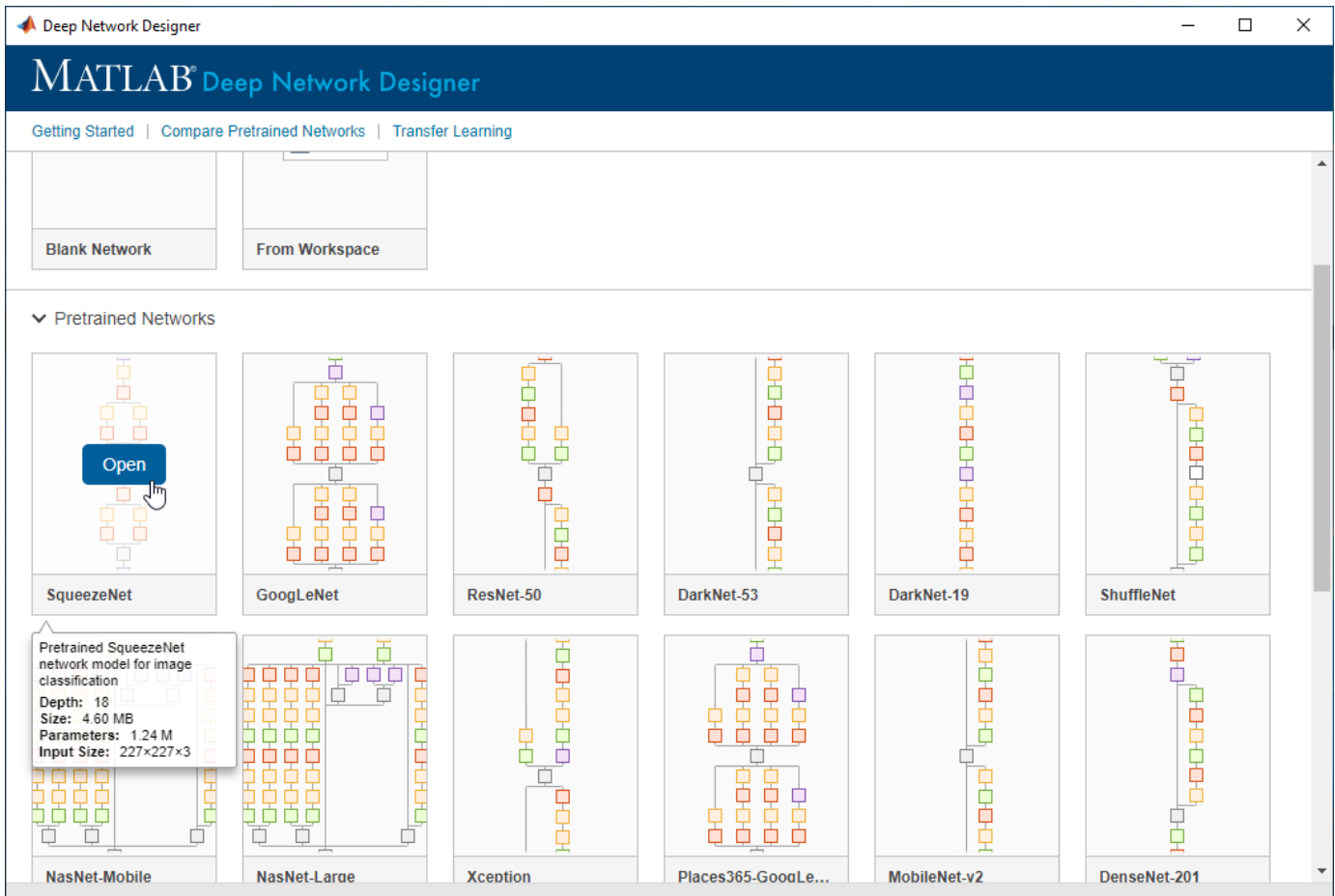

Deep Network Designer displays a zoomed-out view of the whole network in the **Designer** pane.

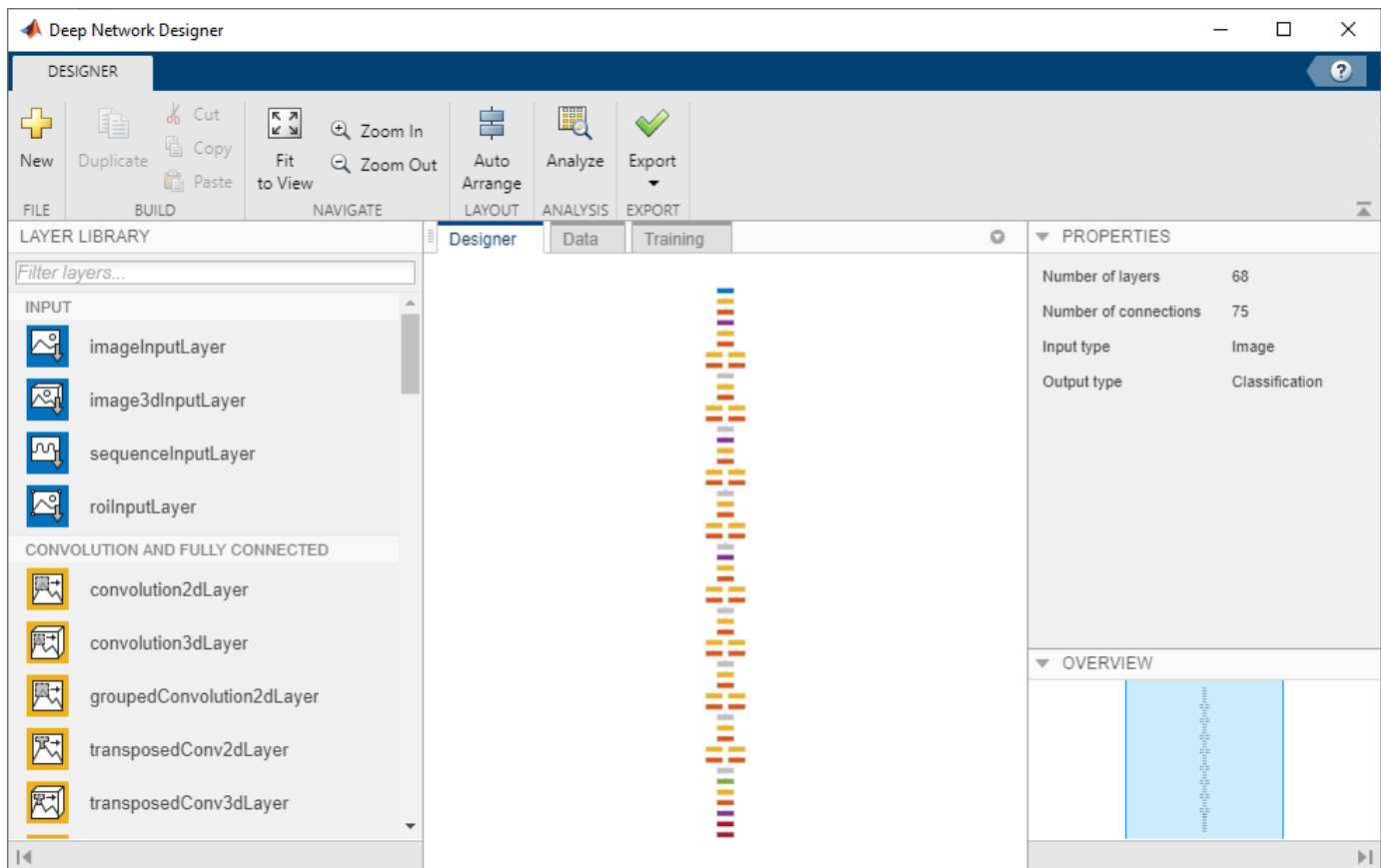

Explore the network plot. To zoom in with the mouse, use **Ctrl**+scroll wheel. To pan, use the arrow keys, or hold down the scroll wheel and drag the mouse. Select a layer to view its properties. Deselect all layers to view the network summary in the **Properties** pane.

### Import Data

To load the data into Deep Network Designer, on the **Data** tab, click **Import Data**. The Import Data dialog box opens.

In the **Data source** list, select **Folder**. Click **Browse** and select the extracted MerchData folder.

Divide the data into 70% training data and 30% validation data.

Specify augmentation operations to perform on the training images. For this example, apply a random reflection in the x-axis, a random rotation from the range  $[-90,90]$  degrees, and a random rescaling from the range  $[1,2]$ . Data augmentation helps prevent the network from overfitting and memorizing the exact details of the training images.

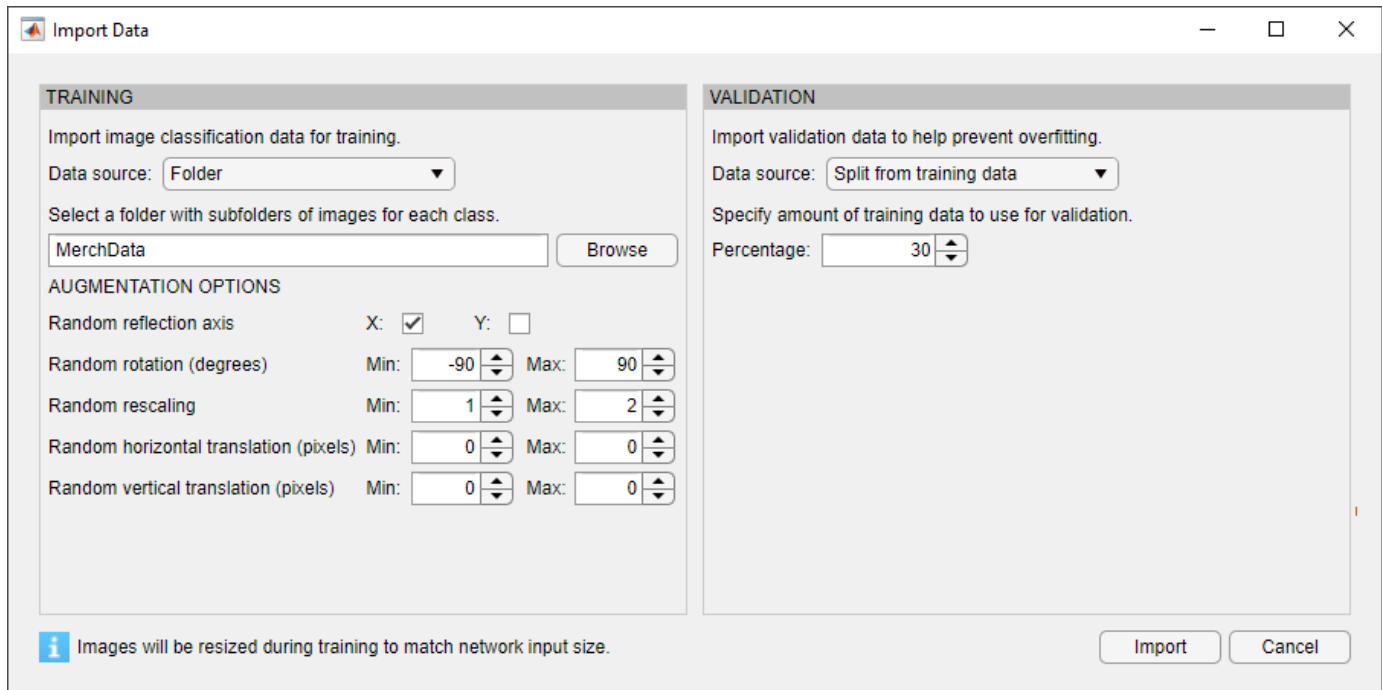

Click **Import** to import the data into Deep Network Designer.

### Visualize Data

Using Deep Network Designer, you can visually inspect the distribution of the training and validation data in the **Data** pane. You can see that, in this example, there are five classes in the data set.



### Edit Network for Transfer Learning

The convolutional layers of the network extract image features that the last learnable layer and the final classification layer use to classify the input image. These two layers, 'conv10' and 'ClassificationLayer\_predictions' in SqueezeNet, contain information on how to combine the features that the network extracts into class probabilities, a loss value, and predicted labels. To retrain a pretrained network to classify new images, replace these two layers with new layers adapted to the new data set.

In most networks, the last layer with learnable weights is a fully connected layer. In some networks, such as SqueezeNet, the last learnable layer is the final convolutional layer instead. In this case, replace the convolutional layer with a new convolutional layer with the number of filters equal to the number of classes.

In the **Designer** pane, drag a new `convolutional2dLayer` onto the canvas. To match the original convolutional layer, set `FilterSize` to 1,1. Change `NumFilters` to the number of classes in the new data, in this example, 5.

Change the learning rates so that learning is faster in the new layer than in the transferred layers by setting `WeightLearnRateFactor` and `BiasLearnRateFactor` to 10. Delete the last 2-D convolutional layer and connect your new layer instead.

The screenshot shows the MATLAB Designer interface with the 'Training' tab selected. The main canvas displays a vertical sequence of layers: 'drop9 dropoutLayer', 'conv convolution2d...', 'relu\_conv10 reluLayer', 'pool10 globalAverage...', 'prob softmaxLayer', and 'Classification... classificationLa...'. The 'conv convolution2d...' layer is highlighted with a blue border. To the right, the 'PROPERTIES' panel for the 'convolution2dLayer' is open, showing various parameters. Several parameters are highlighted with orange boxes: 'FilterSize' (1,1), 'NumFilters' (5), 'WeightLearnRateFactor' (10), and 'BiasLearnRateFactor' (10). Other parameters include 'Stride' (1,1), 'DilationFactor' (1,1), 'Padding' (same), 'Weights' ([]), 'Bias' ([]), 'WeightL2Factor' (1), 'BiasL2Factor' (0), 'WeightsInitializer' (glorot), and 'BiasInitializer' (zeros). The 'OVERVIEW' section is partially visible at the bottom of the properties panel.

Property	Value
Name	conv
FilterSize	1,1
NumFilters	5
Stride	1,1
DilationFactor	1,1
Padding	same
Weights	[]
Bias	[]
WeightLearnRateFactor	10
WeightL2Factor	1
BiasLearnRateFactor	10
BiasL2Factor	0
WeightsInitializer	glorot
BiasInitializer	zeros

Replace the output layer. Scroll to the end of the **Layer Library** and drag a new **classificationLayer** onto the canvas. Delete the original output layer and connect your new layer instead.

The screenshot displays the MATLAB Deep Learning Designer interface. On the left, the 'Designer' tab is active, showing a vertical flow of layers: dropoutLayer, convolution2dLayer, reluLayer, globalAveragePooling2dLayer, softmaxLayer, and classificationLayer. The classificationLayer is highlighted in blue. On the right, the 'PROPERTIES' panel for the selected classificationLayer is shown, with the following settings:

Property	Value
Name	classoutput
Classes	auto
OutputSize	auto
LossFunction	crossentropyex

Below the properties panel, there is an 'OVERVIEW' section with a right-pointing arrow.

### Check Network

To make sure your edited network is ready for training, click **Analyze**, and ensure the Deep Learning Network Analyzer reports zero errors.



Deep Learning Network Analyzer

Network from Deep Network Designer

Analysis date: 15-Jan-2020 16:20:48

68 layers 0 warnings 0 errors

	Name	Type	Activations	Learnables
1	data 227x227x3 images with 'zerocenter' nor...	Image Input	227x227x3	-
2	conv1 64 3x3x3 convolutions with stride [2 2] a...	Convolution	113x113x64	Weights 3x3x3x64 Bias 1x1x64
3	relu_conv1 ReLU	ReLU	113x113x64	-
4	pool1 3x3 max pooling with stride [2 2] and pa...	Max Pooling	56x56x64	-
5	fire2-squeeze1x1 16 1x1x64 convolutions with stride [1 1] ...	Convolution	56x56x16	Weights 1x1x64x16 Bias 1x1x16
6	fire2-relu_squeeze1x1 ReLU	ReLU	56x56x16	-
7	fire2-expand3x3 64 3x3x16 convolutions with stride [1 1] ...	Convolution	56x56x64	Weights 3x3x16x64 Bias 1x1x64
8	fire2-expand1x1 64 1x1x16 convolutions with stride [1 1] ...	Convolution	56x56x64	Weights 1x1x16x64 Bias 1x1x64
9	fire2-relu_expand1x1 ReLU	ReLU	56x56x64	-
10	fire2-relu_expand3x3 ReLU	ReLU	56x56x64	-
11	fire2-concat Depth concatenation of 2 inputs	Depth concatenation	56x56x128	-
12	fire3-squeeze1x1 16 1x1x128 convolutions with stride [1 1]...	Convolution	56x56x16	Weights 1x1x128x16 Bias 1x1x16
13	fire3-relu_squeeze1x1 ReLU	ReLU	56x56x16	-
14	fire3-expand1x1	Convolution	56x56x64	Weights 1x1x16x64

## Train Network

Specify training options. Select the **Training** tab and click **Training Options**.

- Set `InitialLearnRate` to a small value to slow down learning in the transferred layers.
- Specify `ValidationFrequency` so that the accuracy on the validation data is calculated once every epoch.
- Specify a small number of epochs. An epoch is a full training cycle on the entire training data set. For transfer learning, you do not need to train for as many epochs.
- Specify the mini-batch size, that is, how many images to use in each iteration. To ensure the whole data set is used during each epoch, set the mini-batch size to evenly divide the number of training samples.

For this example, set `InitialLearnRate` to 0.0001, `ValidationFrequency` to 5, and `MaxEpochs` to 8. As there are 55 observations, set `MiniBatchSize` to 11.

SOLVER	
Solver	sgdm
InitialLearnRate	0.0001
BASIC	
ValidationFrequency	5
MaxEpochs	8
MiniBatchSize	11
ExecutionEnvironment	auto
ADVANCED	
L2Regularization	0.0001
GradientThresholdMethod	l2norm
GradientThreshold	Inf
ValidationPatience	Inf
Shuffle	every-epoch
CheckpointPath	
LearnRateSchedule	none
LearnRateDropFactor	0.1
LearnRateDropPeriod	10
ResetInputNormalization	<input checked="" type="checkbox"/>
Momentum	0.9

Close

To train the network with the specified training options, click **Close** and then click **Train**.

Deep Network Designer allows you to visualize and monitor training progress. You can then edit the training options and retrain the network, if required.

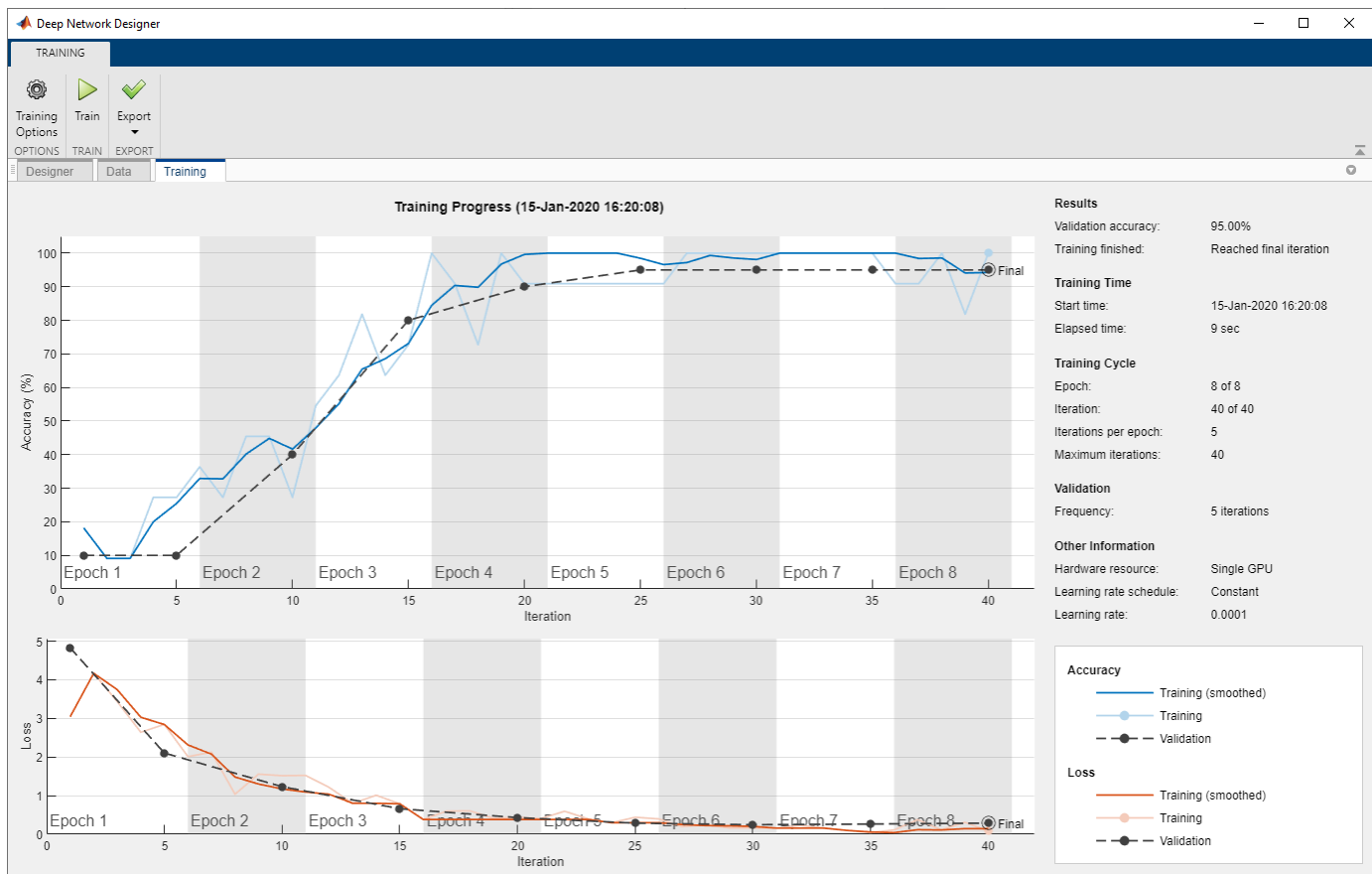

## Export Results and Generate MATLAB Code

To export the network architecture with the trained weights, on the **Training** tab, select **Export > Export Trained Network and Results**. Deep Network Designer exports the trained network as the variable `trainedNetwork_1` and the training info as the variable `trainInfoStruct_1`.

```
trainInfoStruct_1
```

```
trainInfoStruct_1 = struct with fields:
```

```
    TrainingLoss: [1x40 double]
```

```
    TrainingAccuracy: [1x40 double]
```

```
    ValidationLoss: [4.8267 NaN NaN NaN 2.1034 NaN NaN NaN NaN 1.2332 NaN NaN NaN NaN 0
```

```
    ValidationAccuracy: [10 NaN NaN NaN 10 NaN NaN NaN NaN 40 NaN NaN NaN NaN 80 NaN NaN NaN
```

```
    BaseLearnRate: [1x40 double]
```

```
    FinalValidationLoss: 0.2893
```

```
    FinalValidationAccuracy: 95
```

You can also generate MATLAB code, which recreates the network and the training options used. On the **Training** tab, select **Export > Generate Code for Training**. Examine the MATLAB code to learn how to programmatically prepare the data for training, create the network architecture, and train the network.

## Classify New Image

Load a new image to classify using the trained network.

```
I = imread("MerchDataTest.jpg");
```

Deep Network Designer resizes the images during training to match the network input size. To view the network input size, go to the **Designer** pane and select the `imageInputLayer` (first layer). This network has an input size of 227-by-227.

The screenshot shows the Deep Network Designer interface. On the left, a network diagram is displayed with two layers: 'data imageInputLayer' (highlighted with a blue border) and 'conv1 convolution2dL...' (highlighted with a yellow border). An arrow points from the first layer to the second. On the right, the 'PROPERTIES' pane is open for the 'imageInputLayer'. The 'InputSize' property is highlighted with a red border and shows the value '227,227,3'. Other properties include 'Normalization' (zerocenter), 'NormalizationDimension' (auto), 'Mean' ([1x1x3 single]), 'StandardDeviation' ([]), 'Min' ([]), and 'Max' ([]).

Resize the test image to match the network input size.

```
I = imresize(I, [227 227]);
```

Classify the test image using the trained network.

```
[YPred,probs] = classify(trainedNetwork_1,I);
imshow(I)
label = YPred;
title(string(label) + ", " + num2str(100*max(probs),3) + "%");
```



## Programmatic Transfer Learning Using SqueezeNet

This example shows how to fine-tune a pretrained SqueezeNet convolutional neural network to perform classification on a new collection of images.

SqueezeNet has been trained on over a million images and can classify images into 1000 object categories (such as keyboard, coffee mug, pencil, and many animals). The network has learned rich feature representations for a wide range of images. The network takes an image as input and outputs a label for the object in the image together with the probabilities for each of the object categories.

Transfer learning is commonly used in deep learning applications. You can take a pretrained network and use it as a starting point to learn a new task. Fine-tuning a network with transfer learning is usually much faster and easier than training a network with randomly initialized weights from scratch. You can quickly transfer learned features to a new task using a smaller number of training images.

### Reuse Pretrained Network

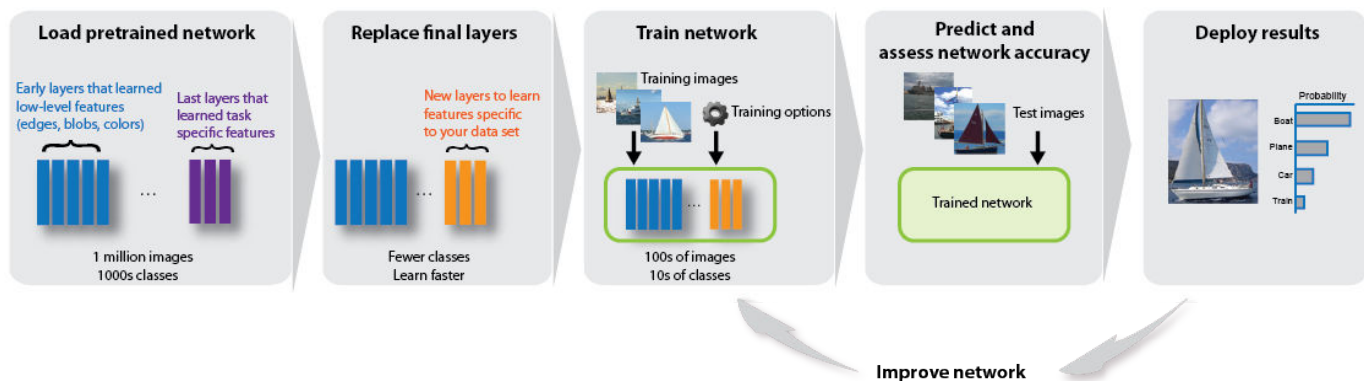

## Load Data

Unzip and load the new images as an image datastore. `imageDatastore` automatically labels the images based on folder names and stores the data as an `ImageDatastore` object. An image datastore enables you to store large image data, including data that does not fit in memory, and efficiently read batches of images during training of a convolutional neural network.

```
unzip('MerchData.zip');
imds = imageDatastore('MerchData', ...
    'IncludeSubfolders',true, ...
    'LabelSource','foldernames');
```

Divide the data into training and validation data sets. Use 70% of the images for training and 30% for validation. `splitEachLabel` splits the `images` datastore into two new datastores.

```
[imdsTrain,imdsValidation] = splitEachLabel(imds,0.7,'randomized');
```

This very small data set now contains 55 training images and 20 validation images. Display some sample images.

```
numTrainImages = numel(imdsTrain.Labels);
idx = randperm(numTrainImages,16);

I = imtile(imds, 'Frames', idx);

figure
imshow(I)
```

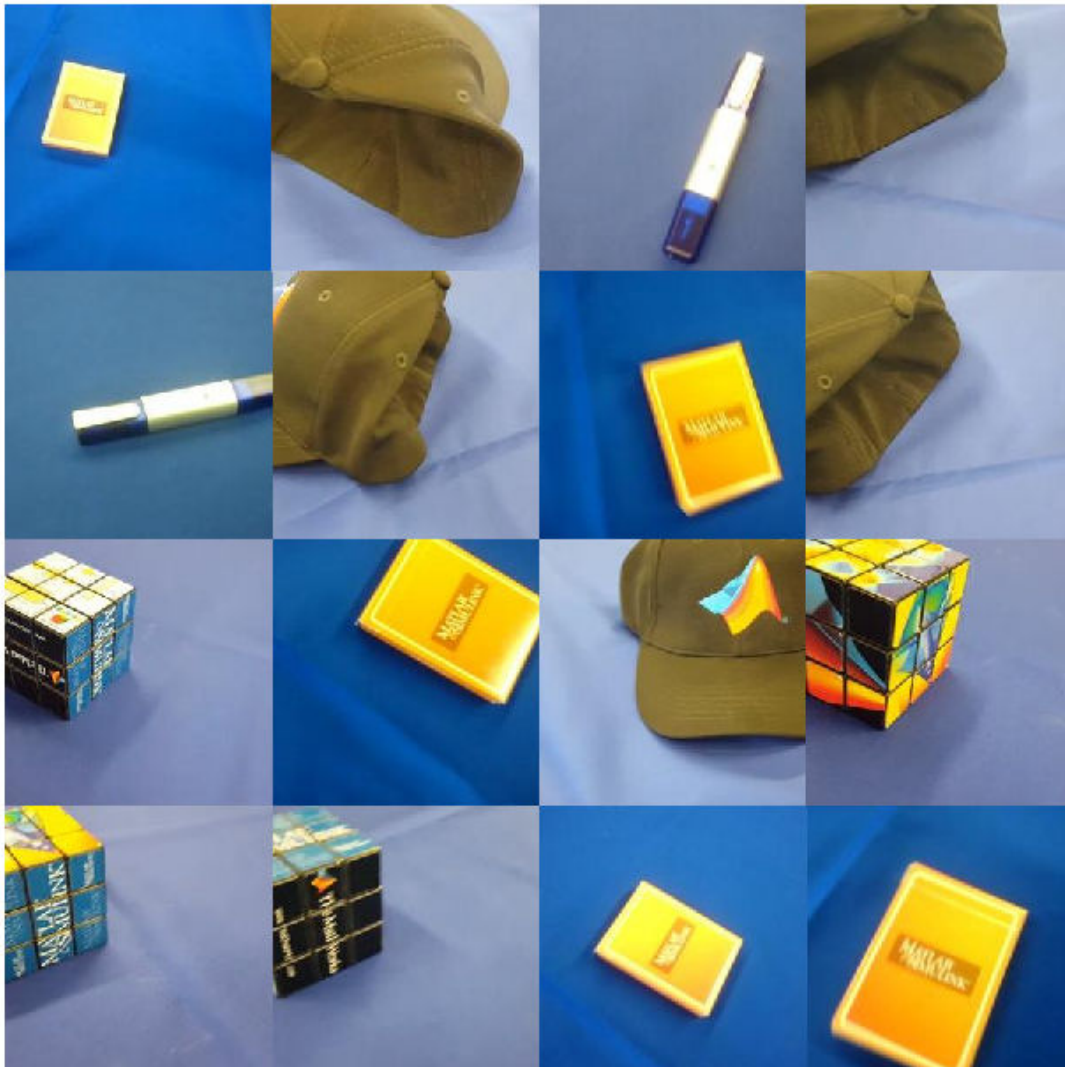

### Load Pretrained Network

Load the pretrained SqueezeNet neural network.

```
net = squeezenet;
```

Use `analyzeNetwork` to display an interactive visualization of the network architecture and detailed information about the network layers.

```
analyzeNetwork(net)
```

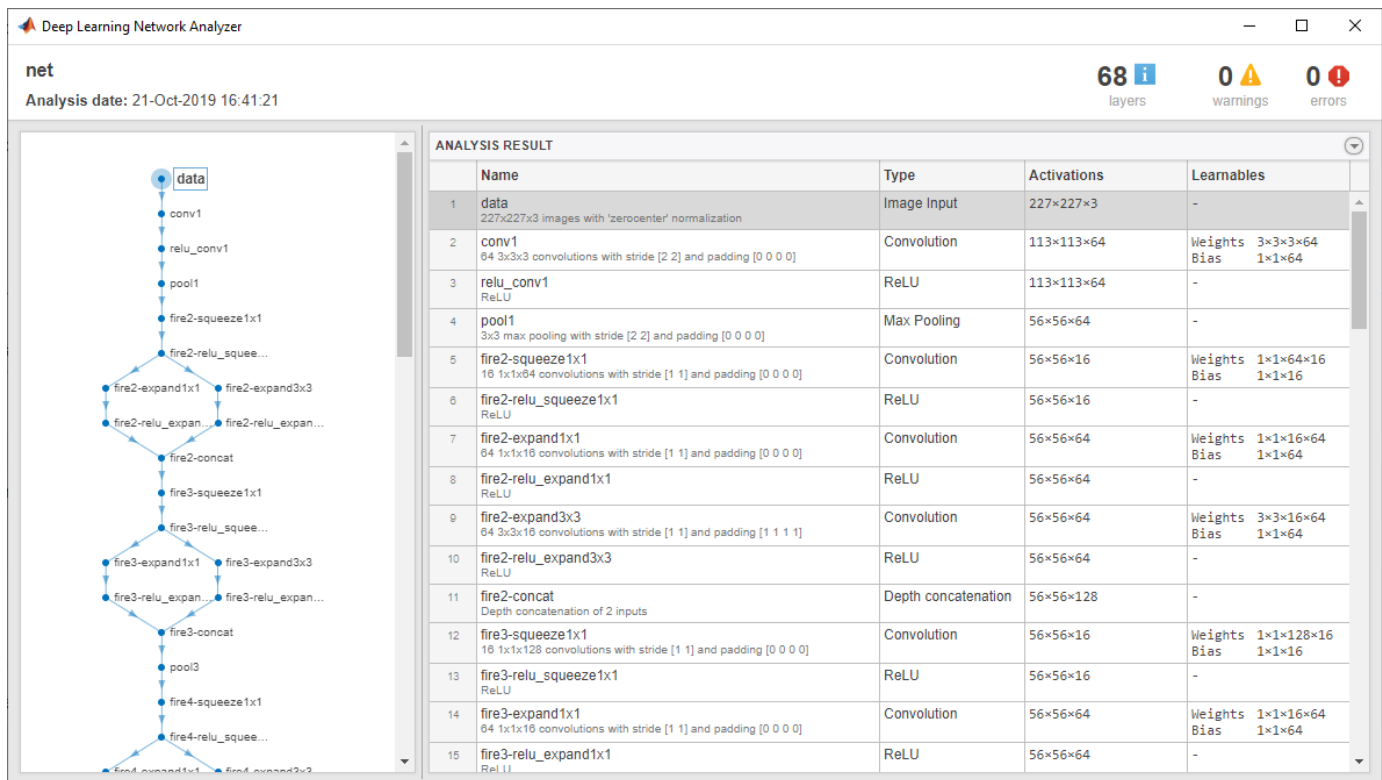

The first layer, the image input layer, requires input images of size 227-by-227-by-3, where 3 is the number of color channels.

```
inputSize = net.Layers(1).InputSize
```

```
inputSize = 1x3
```

```
    227    227    3
```

## Replace Final Layers

The convolutional layers of the network extract image features that the last learnable layer and the final classification layer use to classify the input image. These two layers, 'conv10' and 'ClassificationLayer\_predictions' in SqueezeNet, contain information on how to combine the features that the network extracts into class probabilities, a loss value, and predicted labels. To retrain a pretrained network to classify new images, replace these two layers with new layers adapted to the new data set.

Extract the layer graph from the trained network.

```
lgraph = layerGraph(net);
```

Find the names of the two layers to replace. You can do this manually or you can use the supporting function `findLayersToReplace` to find these layers automatically.

```
[learnableLayer,classLayer] = findLayersToReplace(lgraph);
```

```
ans =  
    1x2 Layer array with layers:
```



```

1  'conv10'          Convolution          1000 1x1x512 convolutions w
2  'ClassificationLayer_predictions'  Classification Output  crossentropyex with 'tench'

```

In most networks, the last layer with learnable weights is a fully connected layer. In some networks, such as SqueezeNet, the last learnable layer is a 1-by-1 convolutional layer instead. In this case, replace the convolutional layer with a new convolutional layer with the number of filters equal to the number of classes. To learn faster in the new layers than in the transferred layers, increase the `WeightLearnRateFactor` and `BiasLearnRateFactor` values of the convolutional layer.

```

numClasses = numel(categories(imdsTrain.Labels))

numClasses = 5

newConvLayer = convolution2dLayer([1, 1],numClasses,'WeightLearnRateFactor',10,'BiasLearnRateFactor',10);
lgraph = replaceLayer(lgraph,'conv10',newConvLayer);

```

The classification layer specifies the output classes of the network. Replace the classification layer with a new one without class labels. `trainNetwork` automatically sets the output classes of the layer at training time.

```

newClassificationLayer = classificationLayer('Name','new_classoutput');
lgraph = replaceLayer(lgraph,'ClassificationLayer_predictions',newClassificationLayer);

```

## Train Network

The network requires input images of size 227-by-227-by-3, but the images in the image datastores have different sizes. Use an augmented image datastore to automatically resize the training images. Specify additional augmentation operations to perform on the training images: randomly flip the training images along the vertical axis, and randomly translate them up to 30 pixels horizontally and vertically. Data augmentation helps prevent the network from overfitting and memorizing the exact details of the training images.

```

pixelRange = [-30 30];
imageAugmenter = imageDataAugmenter( ...
    'RandXReflection',true, ...
    'RandXTranslation',pixelRange, ...
    'RandYTranslation',pixelRange);
augImdsTrain = augmentedImageDatastore(inputSize(1:2),imdsTrain, ...
    'DataAugmentation',imageAugmenter);

```

To automatically resize the validation images without performing further data augmentation, use an augmented image datastore without specifying any additional preprocessing operations.

```

augImdsValidation = augmentedImageDatastore(inputSize(1:2),imdsValidation);

```

Specify the training options. For transfer learning, keep the features from the early layers of the pretrained network (the transferred layer weights). To slow down learning in the transferred layers, set the initial learning rate to a small value. In the previous step, you increased the learning rate factors for the convolutional layer to speed up learning in the new final layers. This combination of learning rate settings results in fast learning only in the new layers and slower learning in the other layers. When performing transfer learning, you do not need to train for as many epochs. An epoch is a full training cycle on the entire training data set. Specify the mini-batch size to be 11 so that in each epoch you consider all of the data. The software validates the network every `ValidationFrequency` iterations during training.

```

options = trainingOptions('sgdm', ...
    'MiniBatchSize',11, ...

```

```

'MaxEpochs',7, ...
'InitialLearnRate',2e-4, ...
'Shuffle','every-epoch', ...
'ValidationData',augimdsValidation, ...
'ValidationFrequency',3, ...
'Verbose',false, ...
'Plots','training-progress');

```

Train the network that consists of the transferred and new layers. By default, `trainNetwork` uses a GPU if one is available (requires Parallel Computing Toolbox™ and a CUDA® enabled GPU with compute capability 3.0 or higher). Otherwise, it uses a CPU. You can also specify the execution environment by using the 'ExecutionEnvironment' name-value pair argument of `trainingOptions`.

```
netTransfer = trainNetwork(augimdsTrain,lgraph,options);
```

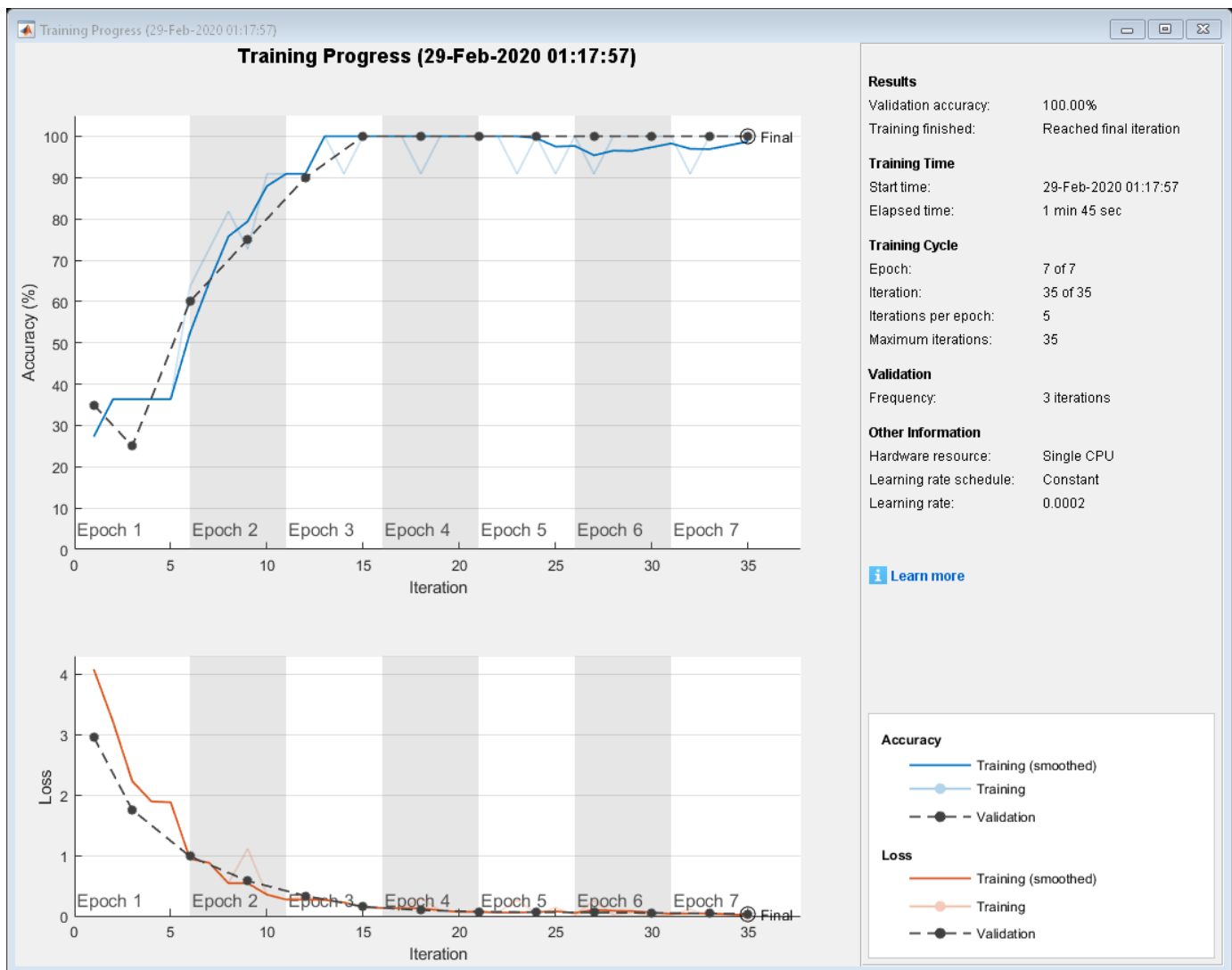

## Classify Validation Images

Classify the validation images using the fine-tuned network.

```
[YPred,scores] = classify(netTransfer,augimdsValidation);
```

Display four sample validation images with their predicted labels.

```
idx = randperm(numel(imdsValidation.Files),4);
figure
for i = 1:4
    subplot(2,2,i)
    I = readimage(imdsValidation,idx(i));
    imshow(I)
    label = YPred(idx(i));
    title(string(label));
end
```

**MathWorks Playing Cards**



**MathWorks Playing Cards**



**MathWorks Cube**



**MathWorks Cube**



Calculate the classification accuracy on the validation set. Accuracy is the fraction of labels that the network predicts correctly.

```
YValidation = imdsValidation.Labels;
accuracy = mean(YPred == YValidation)
```

```
accuracy = 1
```

For tips on improving classification accuracy, see “Deep Learning Tips and Tricks”.

### Classify Image Using SqueezeNet

Read, resize, and classify an image using SqueezeNet.

First, load a pretrained SqueezeNet model.

```
net = squeezenet;
```

Read the image using `imread`.

```
I = imread('peppers.png');  
figure  
imshow(I)
```



The pretrained model requires the image size to be the same as the input size of the network. Determine the input size of the network using the `InputSize` property of the first layer of the network.

```
sz = net.Layers(1).InputSize
```

```
sz = 1×3
```

```
227 227 3
```

Crop the image to the input size of the network. Alternatively, you can resize the image using `imresize`.

```
I = I(1:sz(1),1:sz(2),1:sz(3));  
figure  
imshow(I)
```



Classify the image using `classify`.

```
label = classify(net,I)  
  
label = categorical  
      bell pepper
```

Show the image and classification result together.

```
figure  
imshow(I)  
title(label)
```

**bell pepper**

### Feature Extraction Using SqueezeNet

This example shows how to extract learned image features from a pretrained convolutional neural network, and use those features to train an image classifier. Feature extraction is the easiest and fastest way to use the representational power of pretrained deep networks. For example, you can train a support vector machine (SVM) using `fitcecoc` (Statistics and Machine Learning Toolbox™) on the extracted features. Because feature extraction only requires a single pass through the data, it is a good starting point if you do not have a GPU to accelerate network training with.

#### Load Data

Unzip and load the sample images as an image datastore. `imageDatastore` automatically labels the images based on folder names and stores the data as an `ImageDatastore` object. An image datastore lets you store large image data, including data that does not fit in memory. Split the data into 70% training and 30% test data.

```
unzip('MerchData.zip');  
  
imds = imageDatastore('MerchData', ...  
    'IncludeSubfolders',true, ...  
    'LabelSource','foldernames');  
  
[imdsTrain,imdsTest] = splitEachLabel(imds,0.7,'randomized');
```

This very small data set now has 55 training images and 20 validation images. Display some sample images.

```
numImagesTrain = numel(imdsTrain.Labels);  
idx = randperm(numImagesTrain,16);  
  
I = imtile(imds, 'Frames', idx);
```

figure  
imshow(I)

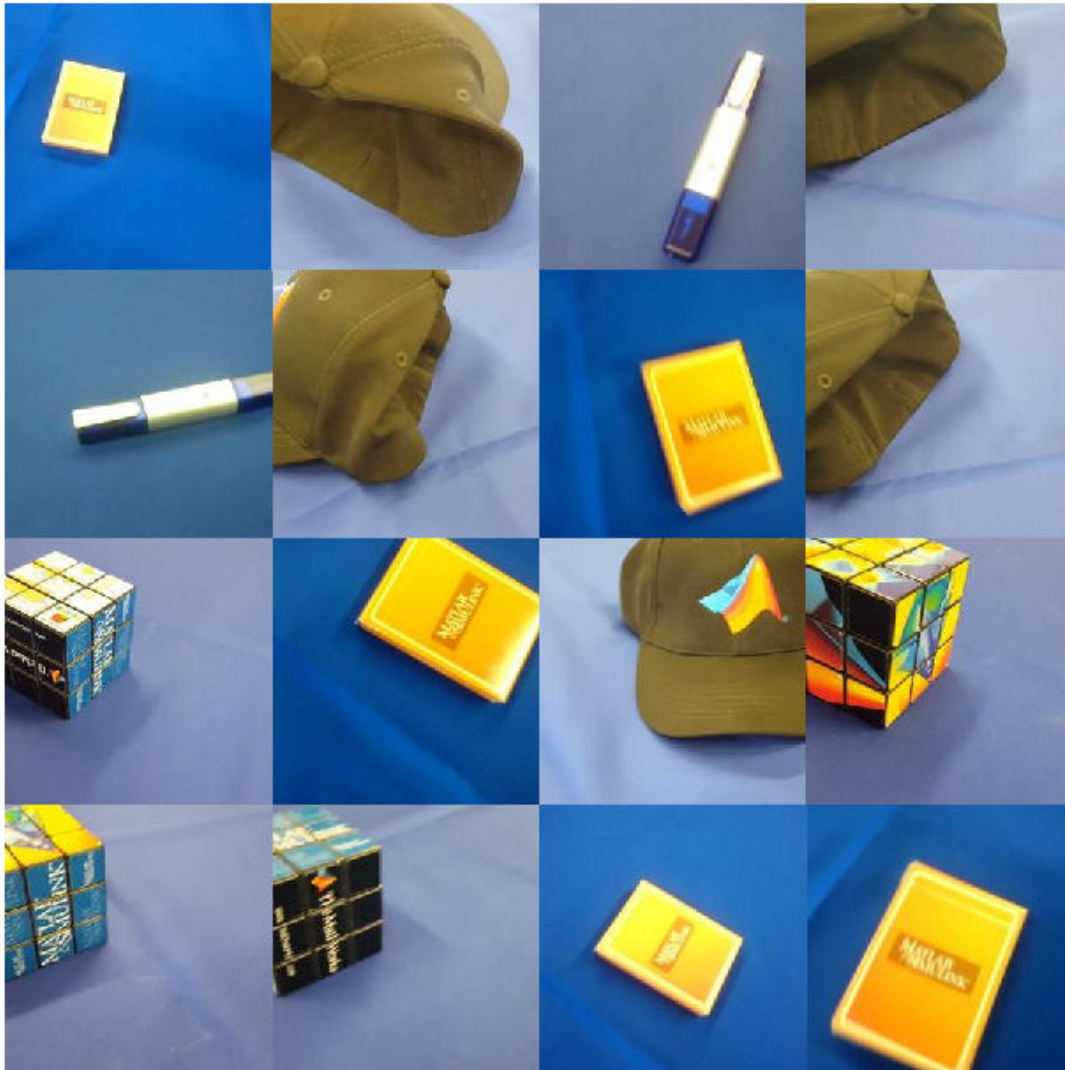

### Load Pretrained Network

Load a pretrained SqueezeNet network. SqueezeNet is trained on more than a million images and can classify images into 1000 object categories, for example, keyboard, mouse, pencil, and many animals. As a result, the model has learned rich feature representations for a wide range of images.

```
net = squeezeNet;
```

Analyze the network architecture.



analyzeNetwork(net)

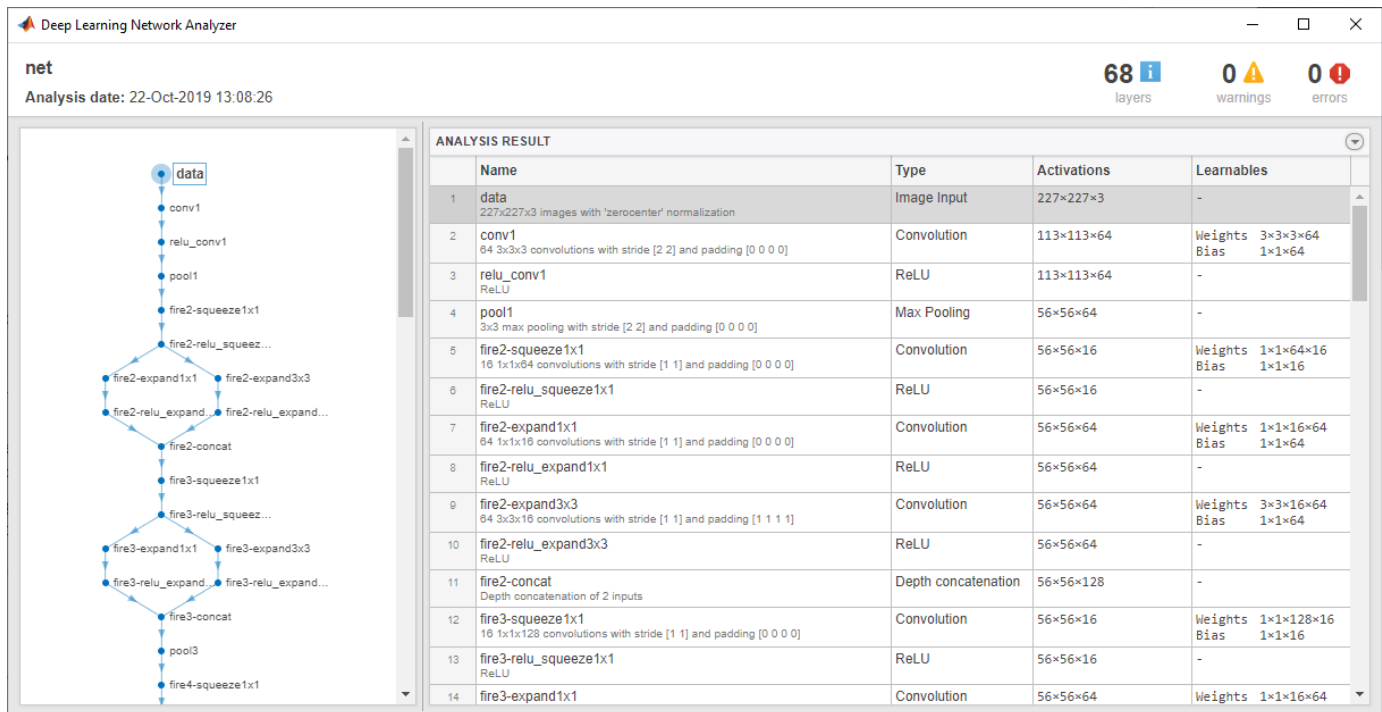

The first layer, the image input layer, requires input images of size 227-by-227-by-3, where 3 is the number of color channels.

```
inputSize = net.Layers(1).InputSize
```

```
inputSize = 1×3
```

```
227 227 3
```

### Extract Image Features

The network constructs a hierarchical representation of input images. Deeper layers contain higher level features, constructed using the lower level features of earlier layers. To get the feature representations of the training and test images, use `activations` on the global average pooling layer 'pool10'. To get a lower level representation of the images, use an earlier layer in the network.

The network requires input images of size 227-by-227-by-3, but the images in the image datastores have different sizes. To automatically resize the training and test images before they are input to the network, create augmented image datastores, specify the desired image size, and use these datastores as input arguments to `activations`.

```
augimdsTrain = augmentedImageDatastore(inputSize(1:2), imdsTrain);
augimdsTest = augmentedImageDatastore(inputSize(1:2), imdsTest);
```

```
layer = 'pool10';
featuresTrain = activations(net, augimdsTrain, layer, 'OutputAs', 'rows');
featuresTest = activations(net, augimdsTest, layer, 'OutputAs', 'rows');
```



Extract the class labels from the training and test data.

```
YTrain = imdsTrain.Labels;  
YTest = imdsTest.Labels;
```

### Fit Image Classifier

Use the features extracted from the training images as predictor variables and fit a multiclass support vector machine (SVM) using `fitcecoc` (Statistics and Machine Learning Toolbox).

```
mdl = fitcecoc(featuresTrain,YTrain);
```

### Classify Test Images

Classify the test images using the trained SVM model and the features extracted from the test images.

```
YPred = predict(mdl,featuresTest);
```

Display four sample test images with their predicted labels.

```
idx = [1 5 10 15];  
figure  
for i = 1:numel(idx)  
    subplot(2,2,i)  
    I = readimage(imdsTest,idx(i));  
    label = YPred(idx(i));  
  
    imshow(I)  
    title(label)  
end
```

**MathWorks Cap**



**MathWorks Cube**



**MathWorks Playing Cards**



**MathWorks Screwdriver**



Calculate the classification accuracy on the test set. Accuracy is the fraction of labels that the network predicts correctly.

```
accuracy = mean(YPred == YTest)
```

```
accuracy = 1
```

This SVM has high accuracy. If the accuracy is not high enough using feature extraction, then try transfer learning instead.

## Output Arguments

**net** — Pretrained SqueezeNet convolutional neural network

DAGNetwork object

Pretrained SqueezeNet convolutional neural network, returned as a DAGNetwork object.

**lgraph** — Untrained SqueezeNet convolutional neural network architecture

LayerGraph object

Untrained SqueezeNet convolutional neural network architecture, returned as a LayerGraph object.

## References

[1] *ImageNet*. <http://www.image-net.org>

[2] Iandola, Forrest N., Song Han, Matthew W. Moskewicz, Khalid Ashraf, William J. Dally, and Kurt Keutzer. "SqueezeNet: AlexNet-level accuracy with 50x fewer parameters and <0.5 MB model size." Preprint, submitted November 4, 2016. <https://arxiv.org/abs/1602.07360>.

[3] Iandola, Forrest N. "SqueezeNet." <https://github.com/forresti/SqueezeNet>.

## Extended Capabilities

### C/C++ Code Generation

Generate C and C++ code using MATLAB® Coder™.

For code generation, load the network by passing the `squeezenet` function to `coder.loadDeepLearningNetwork`. For example: `net = coder.loadDeepLearningNetwork('squeezenet')`.

For more information, see "Load Pretrained Networks for Code Generation" (MATLAB Coder).

The syntax `squeezenet('Weights','none')` is not supported for code generation.

### GPU Code Generation

Generate CUDA® code for NVIDIA® GPUs using GPU Coder™.

Usage notes and limitations:

- For code generation, you can load the network by using the syntax `net = squeezenet` or by passing the `squeezenet` function to `coder.loadDeepLearningNetwork`. For example: `net = coder.loadDeepLearningNetwork('squeezenet')`.

For more information, see "Load Pretrained Networks for Code Generation" (GPU Coder).

- The syntax `squeezenet('Weights','none')` is not supported for GPU code generation.

## See Also

DAGNetwork | **Deep Network Designer** | alexnet | densenet201 | googlenet | inceptionresnetv2 | inceptionv3 | layerGraph | plot | resnet101 | resnet18 | resnet50 | trainNetwork | vgg16 | vgg19

## Topics

"Deep Learning in MATLAB"

"Pretrained Deep Neural Networks"

"Classify Image Using GoogLeNet"

"Train Deep Learning Network to Classify New Images"

"Train Residual Network for Image Classification"

## Introduced in R2018a

## stripdims

Remove dlarray labels

### Syntax

```
y = stripdims(dlX)
```

### Description

`y = stripdims(dlX)` returns the dlarray `dlX` without any labels.

### Examples

#### Remove Labels from dlarray

Create a labeled dlarray.

```
dlX = dlarray(randn(3,2,1,2), 'SSTU')
```

```
dlX =  
  3(S) x 2(S) x 1(T) x 2(U) dlarray
```

```
(:,:,1,1) =
```

```
    0.5377    0.8622  
    1.8339    0.3188  
   -2.2588   -1.3077
```

```
(:,:,1,2) =
```

```
   -0.4336    2.7694  
    0.3426   -1.3499  
    3.5784    3.0349
```

Create an array that is the same as `dlX` but has no labels.

```
y = stripdims(dlX)
```

```
y =  
  3x2x1x2 dlarray
```

```
(:,:,1,1) =
```

```
    0.5377    0.8622  
    1.8339    0.3188  
   -2.2588   -1.3077
```

```
(:, :, 1, 2) =
    -0.4336    2.7694
     0.3426   -1.3499
     3.5784    3.0349
```

## Input Arguments

### **d1X** — Input d1array

d1array object

Input d1array, specified as a d1array object.

Example: `d1X = d1array(randn(3,4), 'ST')`

## Output Arguments

### **y** — Unlabeled d1array

unlabeled d1array object

Unlabeled d1array, returned as an unlabeled d1array object that is the same as the input array d1X, but without any labels. If d1X is unlabeled, then `y = d1X`.

## Tips

- Use `stripdims` to ensure that a d1array behaves like a numeric array of the same size, without any special behavior due to dimension labels.
- `ndims(d1X)` can decrease after a `stripdims` call because the function removes trailing singleton labels.

```
d1X = d1array(ones(3,2), 'SCB');
ndims(d1X)
```

```
ans =
```

```
3
```

```
d1X = stripdims(d1X);
ndims(d1X)
```

```
ans =
```

```
2
```

## See Also

`dims` | `d1array` | `finddim`

**Introduced in R2019b**

# **tanhLayer**

Hyperbolic tangent (tanh) layer

## **Description**

A hyperbolic tangent (tanh) activation layer applies the tanh function on the layer inputs.

## **Creation**

### **Syntax**

```
layer = tanhLayer  
layer = tanhLayer('Name',Name)
```

### **Description**

`layer = tanhLayer` creates a hyperbolic tangent layer.

`layer = tanhLayer('Name',Name)` additionally specifies the optional `Name` property. For example, `tanhLayer('Name','tanh1')` creates a tanh layer with the name 'tanh1'.

## **Properties**

### **Name — Layer name**

' ' (default) | character vector | string scalar

Layer name, specified as a character vector or a string scalar. To include a layer in a layer graph, you must specify a nonempty unique layer name. If you train a series network with the layer and `Name` is set to ' ', then the software automatically assigns a name to the layer at training time.

Data Types: `char` | `string`

### **NumInputs — Number of inputs**

1 (default)

Number of inputs of the layer. This layer accepts a single input only.

Data Types: `double`

### **InputNames — Input names**

{'in'} (default)

Input names of the layer. This layer accepts a single input only.

Data Types: `cell`

### **NumOutputs — Number of outputs**

1 (default)

Number of outputs of the layer. This layer has a single output only.

Data Types: double

### OutputNames — Output names

{ 'out' } (default)

Output names of the layer. This layer has a single output only.

Data Types: cell

## Examples

### Create Hyperbolic Tangent Layer

Create a hyperbolic tangent (tanh) layer with the name 'tanh1'.

```
layer = tanhLayer('Name','tanh1')
```

```
layer =  
    TanhLayer with properties:
```

```
    Name: 'tanh1'
```

```
    Show all properties
```

Include a tanh layer in a Layer array.

```
layers = [  
    imageInputLayer([28 28 1])  
    convolution2dLayer(3,16)  
    batchNormalizationLayer  
    tanhLayer  
  
    maxPooling2dLayer(2,'Stride',2)  
    convolution2dLayer(3,32)  
    batchNormalizationLayer  
    tanhLayer  
  
    fullyConnectedLayer(10)  
    softmaxLayer  
    classificationLayer]
```

```
layers =  
    11x1 Layer array with layers:
```

1	''	Image Input	28x28x1 images with 'zerocenter' normalization
2	''	Convolution	16 3x3 convolutions with stride [1 1] and padding [0 0 0 0]
3	''	Batch Normalization	Batch normalization
4	''	Tanh	Hyperbolic tangent
5	''	Max Pooling	2x2 max pooling with stride [2 2] and padding [0 0 0 0]
6	''	Convolution	32 3x3 convolutions with stride [1 1] and padding [0 0 0 0]
7	''	Batch Normalization	Batch normalization
8	''	Tanh	Hyperbolic tangent
9	''	Fully Connected	10 fully connected layer
10	''	Softmax	softmax
11	''	Classification Output	crossentropyex

## **Extended Capabilities**

### **GPU Code Generation**

Generate CUDA® code for NVIDIA® GPUs using GPU Coder™.

### **See Also**

`batchNormalizationLayer` | `clippedReluLayer` | `leakyReluLayer` | `reluLayer` | `trainNetwork`

### **Topics**

[“Create Simple Deep Learning Network for Classification”](#)

[“Train Convolutional Neural Network for Regression”](#)

[“Deep Learning in MATLAB”](#)

[“Specify Layers of Convolutional Neural Network”](#)

[“List of Deep Learning Layers”](#)

### **Introduced in R2019a**



# trainingOptions

Options for training deep learning neural network

## Syntax

```
options = trainingOptions(solverName)
options = trainingOptions(solverName,Name,Value)
```

## Description

`options = trainingOptions(solverName)` returns training options for the optimizer specified by `solverName`. To train a network, use the training options as an input argument to the `trainNetwork` function.

`options = trainingOptions(solverName,Name,Value)` returns training options with additional options specified by one or more name-value pair arguments.

## Examples

### Specify Training Options

Create a set of options for training a network using stochastic gradient descent with momentum. Reduce the learning rate by a factor of 0.2 every 5 epochs. Set the maximum number of epochs for training to 20, and use a mini-batch with 64 observations at each iteration. Turn on the training progress plot.

```
options = trainingOptions('sgdm', ...
    'LearnRateSchedule','piecewise', ...
    'LearnRateDropFactor',0.2, ...
    'LearnRateDropPeriod',5, ...
    'MaxEpochs',20, ...
    'MiniBatchSize',64, ...
    'Plots','training-progress')
```

```
options =
  TrainingOptionsSGDM with properties:
        Momentum: 0.9000
      InitialLearnRate: 0.0100
    LearnRateSchedule: 'piecewise'
  LearnRateDropFactor: 0.2000
  LearnRateDropPeriod: 5
      L2Regularization: 1.0000e-04
  GradientThresholdMethod: 'l2norm'
      GradientThreshold: Inf
          MaxEpochs: 20
      MiniBatchSize: 64
            Verbose: 1
  VerboseFrequency: 50
      ValidationData: []
```

```
ValidationFrequency: 50
ValidationPatience: Inf
    Shuffle: 'once'
CheckpointPath: ''
ExecutionEnvironment: 'auto'
    WorkerLoad: []
    OutputFcn: []
    Plots: 'training-progress'
    SequenceLength: 'longest'
SequencePaddingValue: 0
SequencePaddingDirection: 'right'
DispatchInBackground: 0
ResetInputNormalization: 1
```

## Monitor Deep Learning Training Progress

When you train networks for deep learning, it is often useful to monitor the training progress. By plotting various metrics during training, you can learn how the training is progressing. For example, you can determine if and how quickly the network accuracy is improving, and whether the network is starting to overfit the training data.

When you specify 'training-progress' as the 'Plots' value in `trainingOptions` and start network training, `trainNetwork` creates a figure and displays training metrics at every iteration. Each iteration is an estimation of the gradient and an update of the network parameters. If you specify validation data in `trainingOptions`, then the figure shows validation metrics each time `trainNetwork` validates the network. The figure plots the following:

- **Training accuracy** — Classification accuracy on each individual mini-batch.
- **Smoothed training accuracy** — Smoothed training accuracy, obtained by applying a smoothing algorithm to the training accuracy. It is less noisy than the unsmoothed accuracy, making it easier to spot trends.
- **Validation accuracy** — Classification accuracy on the entire validation set (specified using `trainingOptions`).
- **Training loss, smoothed training loss, and validation loss** — The loss on each mini-batch, its smoothed version, and the loss on the validation set, respectively. If the final layer of your network is a `classificationLayer`, then the loss function is the cross entropy loss. For more information about loss functions for classification and regression problems, see “Output Layers”.

For regression networks, the figure plots the root mean square error (RMSE) instead of the accuracy.

The figure marks each training **Epoch** using a shaded background. An epoch is a full pass through the entire data set.

During training, you can stop training and return the current state of the network by clicking the stop button in the top-right corner. For example, you might want to stop training when the accuracy of the network reaches a plateau and it is clear that the accuracy is no longer improving. After you click the stop button, it can take a while for the training to complete. Once training is complete, `trainNetwork` returns the trained network.

When training finishes, view the **Results** showing the final validation accuracy and the reason that training finished. The final validation metrics are labeled **Final** in the plots. If your network contains

batch normalization layers, then the final validation metrics are often different from the validation metrics evaluated during training. This is because batch normalization layers in the final network perform different operations than during training.

On the right, view information about the training time and settings. To learn more about training options, see “Set Up Parameters and Train Convolutional Neural Network”.

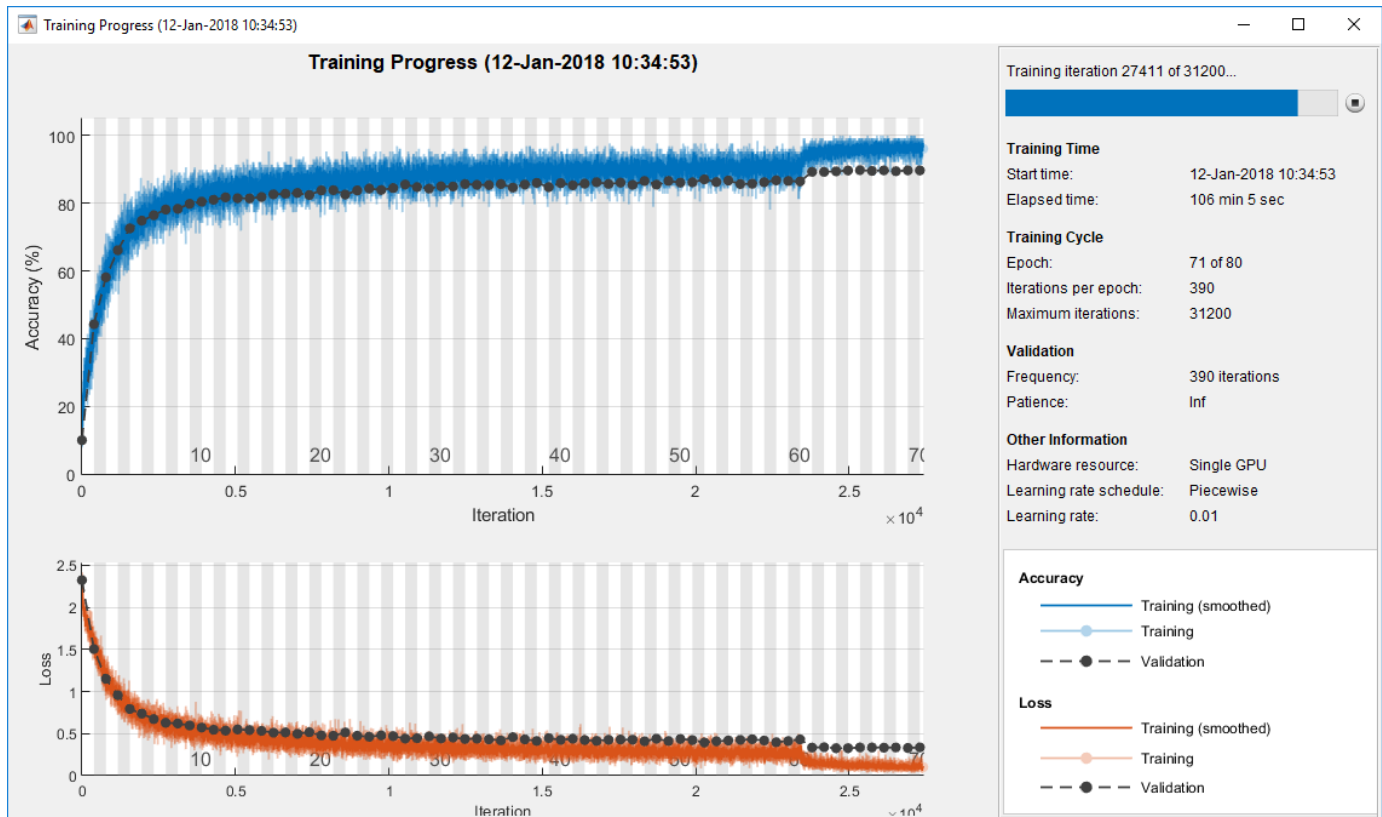

## Plot Training Progress During Training

Train a network and plot the training progress during training.

Load the training data, which contains 5000 images of digits. Set aside 1000 of the images for network validation.

```
[XTrain,YTrain] = digitTrain4DArrayData;
```

```
idx = randperm(size(XTrain,4),1000);
XValidation = XTrain(:,:,,idx);
XTrain(:,:,,idx) = [];
YValidation = YTrain(idx);
YTrain(idx) = [];
```

Construct a network to classify the digit image data.

```
layers = [
    imageInputLayer([28 28 1])
    convolution2dLayer(3,8,'Padding','same')
```

```
batchNormalizationLayer
reluLayer

maxPooling2dLayer(2, 'Stride', 2)

convolution2dLayer(3, 16, 'Padding', 'same')
batchNormalizationLayer
reluLayer

maxPooling2dLayer(2, 'Stride', 2)

convolution2dLayer(3, 32, 'Padding', 'same')
batchNormalizationLayer
reluLayer

fullyConnectedLayer(10)
softmaxLayer
classificationLayer];
```

Specify options for network training. To validate the network at regular intervals during training, specify validation data. Choose the 'ValidationFrequency' value so that the network is validated about once per epoch. To plot training progress during training, specify 'training-progress' as the 'Plots' value.

```
options = trainingOptions('sgdm', ...
    'MaxEpochs', 8, ...
    'ValidationData', {XValidation, YValidation}, ...
    'ValidationFrequency', 30, ...
    'Verbose', false, ...
    'Plots', 'training-progress');
```

Train the network.

```
net = trainNetwork(XTrain, YTrain, layers, options);
```

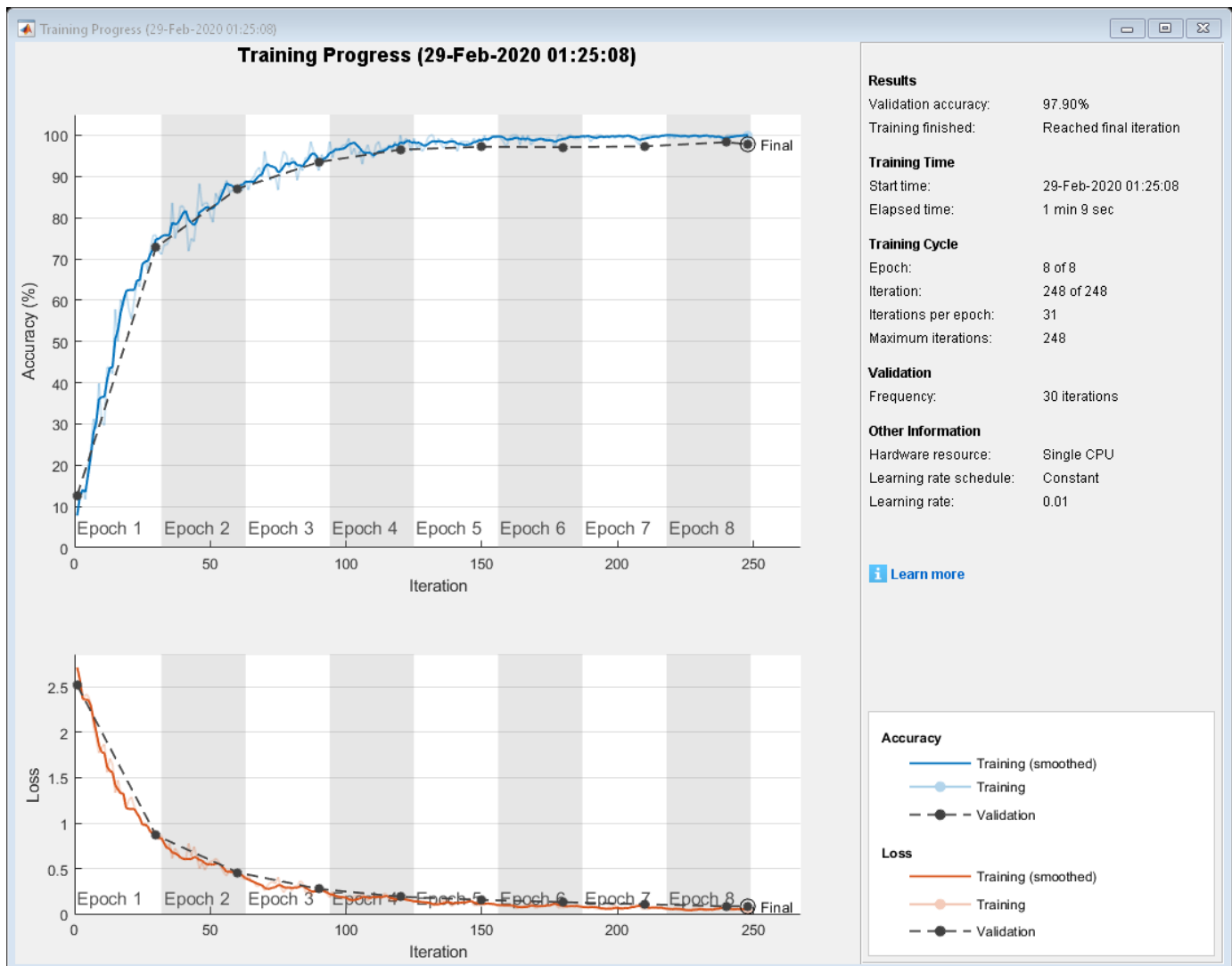

## Input Arguments

### **solverName** — Solver for training network

'sgdm' | 'rmsprop' | 'adam'

Solver for training network, specified as one of the following:

- 'sgdm' — Use the stochastic gradient descent with momentum (SGDM) optimizer. You can specify the momentum value using the 'Momentum' name-value pair argument.
- 'rmsprop' — Use the RMSProp optimizer. You can specify the decay rate of the squared gradient moving average using the 'SquaredGradientDecayFactor' name-value pair argument.
- 'adam' — Use the Adam optimizer. You can specify the decay rates of the gradient and squared gradient moving averages using the 'GradientDecayFactor' and 'SquaredGradientDecayFactor' name-value pair arguments, respectively.

For more information about the different solvers, see “Stochastic Gradient Descent” on page 1-800.

### **Name-Value Pair Arguments**

Specify optional comma-separated pairs of `Name`, `Value` arguments. `Name` is the argument name and `Value` is the corresponding value. `Name` must appear inside quotes. You can specify several name and value pair arguments in any order as `Name1, Value1, ..., NameN, ValueN`.

Example:

```
'InitialLearnRate', 0.03, 'L2Regularization', 0.0005, 'LearnRateSchedule', 'piecewise'
```

specifies the initial learning rate as 0.03 and the  $L_2$  regularization factor as 0.0005, and instructs the software to drop the learning rate every given number of epochs by multiplying with a certain factor.

### **Plots and Display**

#### **Plots — Plots to display during network training**

'none' (default) | 'training-progress'

Plots to display during network training, specified as the comma-separated pair consisting of 'Plots' and one of the following:

- 'none' — Do not display plots during training.
- 'training-progress' — Plot training progress. The plot shows mini-batch loss and accuracy, validation loss and accuracy, and additional information on the training progress. The plot has a stop button  in the top-right corner. Click the button to stop training and return the current state of the network. For more information on the training progress plot, see “Monitor Deep Learning Training Progress” on page 1-784.

Example: 'Plots', 'training-progress'

#### **Verbose — Indicator to display training progress information**

1 (true) (default) | 0 (false)

Indicator to display training progress information in the command window, specified as the comma-separated pair consisting of 'Verbose' and either 1 (true) or 0 (false).

The verbose output displays the following information:

**Classification Networks**

<b>Field</b>	<b>Description</b>
Epoch	Epoch number. An epoch corresponds to a full pass of the data.
Iteration	Iteration number. An iteration corresponds to a mini-batch.
Time Elapsed	Time elapsed in hours, minutes, and seconds.
Mini-batch Accuracy	Classification accuracy on the mini-batch.
Validation Accuracy	Classification accuracy on the validation data. If you do not specify validation data, then the function does not display this field.
Mini-batch Loss	Loss on the mini-batch. If the output layer is a <code>ClassificationOutputLayer</code> object, then the loss is the cross entropy loss for multi-class classification problems with mutually exclusive classes.
Validation Loss	Loss on the validation data. If the output layer is a <code>ClassificationOutputLayer</code> object, then the loss is the cross entropy loss for multi-class classification problems with mutually exclusive classes. If you do not specify validation data, then the function does not display this field.
Base Learning Rate	Base learning rate. The software multiplies the learn rate factors of the layers by this value.

## Regression Networks

Field	Description
Epoch	Epoch number. An epoch corresponds to a full pass of the data.
Iteration	Iteration number. An iteration corresponds to a mini-batch.
Time Elapsed	Time elapsed in hours, minutes, and seconds.
Mini-batch RMSE	Root-mean-squared-error (RMSE) on the mini-batch.
Validation RMSE	RMSE on the validation data. If you do not specify validation data, then the software does not display this field.
Mini-batch Loss	Loss on the mini-batch. If the output layer is a <code>RegressionOutputLayer</code> object, then the loss is the half-mean-squared-error.
Validation Loss	Loss on the validation data. If the output layer is a <code>RegressionOutputLayer</code> object, then the loss is the half-mean-squared-error. If you do not specify validation data, then the software does not display this field.
Base Learning Rate	Base learning rate. The software multiplies the learn rate factors of the layers by this value.

To specify validation data, use the 'ValidationData' name-value pair.

Example: 'Verbose', false

### VerboseFrequency — Frequency of verbose printing

50 (default) | positive integer

Frequency of verbose printing, which is the number of iterations between printing to the command window, specified as the comma-separated pair consisting of 'VerboseFrequency' and a positive integer. This option only has an effect when the 'Verbose' value equals true.

If you validate the network during training, then `trainNetwork` also prints to the command window every time validation occurs.

Example: 'VerboseFrequency', 100

### Mini-Batch Options

#### MaxEpochs — Maximum number of epochs

30 (default) | positive integer

Maximum number of epochs to use for training, specified as the comma-separated pair consisting of 'MaxEpochs' and a positive integer.

An iteration is one step taken in the gradient descent algorithm towards minimizing the loss function using a mini-batch. An epoch is the full pass of the training algorithm over the entire training set.

Example: 'MaxEpochs', 20



**MiniBatchSize — Size of mini-batch**

128 (default) | positive integer

Size of the mini-batch to use for each training iteration, specified as the comma-separated pair consisting of 'MiniBatchSize' and a positive integer. A mini-batch is a subset of the training set that is used to evaluate the gradient of the loss function and update the weights. See “Stochastic Gradient Descent” on page 1-800.

Example: 'MiniBatchSize',256

**Shuffle — Option for data shuffling**

'once' (default) | 'never' | 'every-epoch'

Option for data shuffling, specified as the comma-separated pair consisting of 'Shuffle' and one of the following:

- 'once' — Shuffle the training and validation data once before training.
- 'never' — Do not shuffle the data.
- 'every-epoch' — Shuffle the training data before each training epoch, and shuffle the validation data before each network validation. If the mini-batch size does not evenly divide the number of training samples, then `trainNetwork` discards the training data that does not fit into the final complete mini-batch of each epoch. To avoid discarding the same data every epoch, set the 'Shuffle' value to 'every-epoch'.

Example: 'Shuffle', 'every-epoch'

**Validation****ValidationData — Data to use for validation during training**

image datastore | datastore | table | cell array

Data to use for validation during training, specified as an image datastore, a datastore that returns data in a two-column table or two-column cell array, a table, or a cell array. The format of the validation data depends on the type of task and correspond to valid inputs to the `trainNetwork` function.

This option supports networks with a single input only.

**Image Data**

For image data, specify the validation data as one of the following:

Input	Description	More Information
Image datastore	ImageDatastore object with categorical labels.	imds argument of <code>trainNetwork</code>

Input		Description	More Information
Datastore		Datastore that returns data in a two-column table or two-column cell array, where the two columns specify the network inputs and expected responses, respectively.	ds argument of <code>trainNetwork</code>
Table		Table, where the first column contains either image paths or images, and the subsequent columns contain the responses.	tbl argument of <code>trainNetwork</code>
Cell array {X,Y}	X	Numeric array of images.	X argument of <code>trainNetwork</code>
	Y	Categorical vector of labels, matrix of numeric responses, or array of images.	Y argument of <code>trainNetwork</code>

### Sequence and Time Series Data

For sequence and time series data, specify the validation data as one of the following:

Input		Description	More Information
Cell array {sequences,Y}	sequences	Cell array of sequences or time series data.	sequences argument of <code>trainNetwork</code>
	Y	Categorical vector of labels, cell array of categorical sequences, matrix of numeric responses, or cell array of numeric sequences.	Y argument of <code>trainNetwork</code>
Table		Table containing absolute or relative file paths to a MAT files containing sequence or time series data.	tbl argument of <code>trainNetwork</code>

During training, `trainNetwork` calculates the validation accuracy and validation loss on the validation data. To specify the validation frequency, use the 'ValidationFrequency' name-value pair argument. You can also use the validation data to stop training automatically when the validation loss stops decreasing. To turn on automatic validation stopping, use the 'ValidationPatience' name-value pair argument.

If your network has layers that behave differently during prediction than during training (for example, dropout layers), then the validation accuracy can be higher than the training (mini-batch) accuracy.

The validation data is shuffled according to the 'Shuffle' value. If the 'Shuffle' value equals 'every-epoch', then the validation data is shuffled before each network validation.

### **ValidationFrequency — Frequency of network validation**

50 (default) | positive integer

Frequency of network validation in number of iterations, specified as the comma-separated pair consisting of 'ValidationFrequency' and a positive integer.

The 'ValidationFrequency' value is the number of iterations between evaluations of validation metrics. To specify validation data, use the 'ValidationData' name-value pair argument.

Example: 'ValidationFrequency',20

### **ValidationPatience — Patience of validation stopping**

Inf (default) | positive integer

Patience of validation stopping of network training, specified as the comma-separated pair consisting of 'ValidationPatience' and a positive integer or Inf.

The 'ValidationPatience' value is the number of times that the loss on the validation set can be larger than or equal to the previously smallest loss before network training stops. To turn on automatic validation stopping, specify a positive integer as the 'ValidationPatience' value. If you use the default value of Inf, then the training stops after the maximum number of epochs. To specify validation data, use the 'ValidationData' name-value pair argument.

Example: 'ValidationPatience',5

## **Solver Options**

### **InitialLearnRate — Initial learning rate**

0.001 | 0.01 | positive scalar

Initial learning rate used for training, specified as the comma-separated pair consisting of 'InitialLearnRate' and a positive scalar. The default value is 0.01 for the 'sgdm' solver and 0.001 for the 'rmsprop' and 'adam' solvers. If the learning rate is too low, then training takes a long time. If the learning rate is too high, then training might reach a suboptimal result or diverge.

Example: 'InitialLearnRate',0.03

Data Types: single | double

### **LearnRateSchedule — Option for dropping learning rate during training**

'none' (default) | 'piecewise'

Option for dropping the learning rate during training, specified as the comma-separated pair consisting of 'LearnRateSchedule' and one of the following:

- 'none' — The learning rate remains constant throughout training.
- 'piecewise' — The software updates the learning rate every certain number of epochs by multiplying with a certain factor. Use the `LearnRateDropFactor` name-value pair argument to specify the value of this factor. Use the `LearnRateDropPeriod` name-value pair argument to specify the number of epochs between multiplications.

Example: 'LearnRateSchedule','piecewise'

**LearnRateDropPeriod — Number of epochs for dropping the learning rate**

10 (default) | positive integer

Number of epochs for dropping the learning rate, specified as the comma-separated pair consisting of 'LearnRateDropPeriod' and a positive integer. This option is valid only when the value of LearnRateSchedule is 'piecewise'.

The software multiplies the global learning rate with the drop factor every time the specified number of epochs passes. Specify the drop factor using the LearnRateDropFactor name-value pair argument.

Example: 'LearnRateDropPeriod',3

**LearnRateDropFactor — Factor for dropping the learning rate**

0.1 (default) | scalar from 0 to 1

Factor for dropping the learning rate, specified as the comma-separated pair consisting of 'LearnRateDropFactor' and a scalar from 0 to 1. This option is valid only when the value of LearnRateSchedule is 'piecewise'.

LearnRateDropFactor is a multiplicative factor to apply to the learning rate every time a certain number of epochs passes. Specify the number of epochs using the LearnRateDropPeriod name-value pair argument.

Example: 'LearnRateDropFactor',0.1

Data Types: single | double

**L2Regularization — Factor for L<sub>2</sub> regularization**

0.0001 (default) | nonnegative scalar

Factor for L<sub>2</sub> regularization (weight decay), specified as the comma-separated pair consisting of 'L2Regularization' and a nonnegative scalar. For more information, see “L2 Regularization” on page 1-803.

You can specify a multiplier for the L<sub>2</sub> regularization for network layers with learnable parameters. For more information, see “Set Up Parameters in Convolutional and Fully Connected Layers”.

Example: 'L2Regularization',0.0005

Data Types: single | double

**Momentum — Contribution of previous step**

0.9 (default) | scalar from 0 to 1

Contribution of the parameter update step of the previous iteration to the current iteration of stochastic gradient descent with momentum, specified as the comma-separated pair consisting of 'Momentum' and a scalar from 0 to 1. A value of 0 means no contribution from the previous step, whereas a value of 1 means maximal contribution from the previous step.

To specify the 'Momentum' value, you must set solverName to be 'sgdm'. The default value works well for most problems. For more information about the different solvers, see “Stochastic Gradient Descent” on page 1-800.

Example: 'Momentum',0.95

Data Types: single | double

**GradientDecayFactor — Decay rate of gradient moving average**

0.9 (default) | nonnegative scalar less than 1

Decay rate of gradient moving average for the Adam solver, specified as the comma-separated pair consisting of 'GradientDecayFactor' and a nonnegative scalar less than 1. The gradient decay rate is denoted by  $\beta_1$  in [4].

To specify the 'GradientDecayFactor' value, you must set `solverName` to be 'adam'. The default value works well for most problems. For more information about the different solvers, see “Stochastic Gradient Descent” on page 1-800.

Example: 'GradientDecayFactor',0.95

Data Types: single | double

**SquaredGradientDecayFactor — Decay rate of squared gradient moving average**

0.9 | 0.999 | nonnegative scalar less than 1

Decay rate of squared gradient moving average for the Adam and RMSProp solvers, specified as the comma-separated pair consisting of 'SquaredGradientDecayFactor' and a nonnegative scalar less than 1. The squared gradient decay rate is denoted by  $\beta_2$  in [4].

To specify the 'SquaredGradientDecayFactor' value, you must set `solverName` to be 'adam' or 'rmsprop'. Typical values of the decay rate are 0.9, 0.99, and 0.999, corresponding to averaging lengths of 10, 100, and 1000 parameter updates, respectively. The default value is 0.999 for the Adam solver. The default value is 0.9 for the RMSProp solver.

For more information about the different solvers, see “Stochastic Gradient Descent” on page 1-800.

Example: 'SquaredGradientDecayFactor',0.99

Data Types: single | double

**Epsilon — Denominator offset**10<sup>-8</sup> (default) | positive scalar

Denominator offset for Adam and RMSProp solvers, specified as the comma-separated pair consisting of 'Epsilon' and a positive scalar. The solver adds the offset to the denominator in the network parameter updates to avoid division by zero.

To specify the 'Epsilon' value, you must set `solverName` to be 'adam' or 'rmsprop'. The default value works well for most problems. For more information about the different solvers, see “Stochastic Gradient Descent” on page 1-800.

Example: 'Epsilon',1e-6

Data Types: single | double

**ResetInputNormalization — Option to reset input layer normalization**

true (default) | false

Option to reset input layer normalization, specified as one of the following:

- `true` - Reset the input layer normalization statistics and recalculate them at training time.
- `false` - Calculate normalization statistics at training time when they are empty.

## Gradient Clipping

### GradientThreshold — Gradient threshold

Inf (default) | positive scalar

Gradient threshold, specified as the comma-separated pair consisting of 'GradientThreshold' and Inf or a positive scalar. If the gradient exceeds the value of GradientThreshold, then the gradient is clipped according to GradientThresholdMethod.

Example: 'GradientThreshold',6

### GradientThresholdMethod — Gradient threshold method

'l2norm' (default) | 'global-l2norm' | 'absolute-value'

Gradient threshold method used to clip gradient values that exceed the gradient threshold, specified as the comma-separated pair consisting of 'GradientThresholdMethod' and one of the following:

- 'l2norm' — If the  $L_2$  norm of the gradient of a learnable parameter is larger than GradientThreshold, then scale the gradient so that the  $L_2$  norm equals GradientThreshold.
- 'global-l2norm' — If the global  $L_2$  norm,  $L$ , is larger than GradientThreshold, then scale all gradients by a factor of GradientThreshold/ $L$ . The global  $L_2$  norm considers all learnable parameters.
- 'absolute-value' — If the absolute value of an individual partial derivative in the gradient of a learnable parameter is larger than GradientThreshold, then scale the partial derivative to have magnitude equal to GradientThreshold and retain the sign of the partial derivative.

For more information, see Gradient Clipping on page 1-802.

Example: 'GradientThresholdMethod', 'global-l2norm'

## Sequence Options

### SequenceLength — Option to pad, truncate, or split input sequences

'longest' (default) | 'shortest' | positive integer

Option to pad, truncate, or split input sequences, specified as one of the following:

- 'longest' — Pad sequences in each mini-batch to have the same length as the longest sequence. This option does not discard any data, though padding can introduce noise to the network.
- 'shortest' — Truncate sequences in each mini-batch to have the same length as the shortest sequence. This option ensures that no padding is added, at the cost of discarding data.
- Positive integer — For each mini-batch, pad the sequences to the nearest multiple of the specified length that is greater than the longest sequence length in the mini-batch, and then split the sequences into smaller sequences of the specified length. If splitting occurs, then the software creates extra mini-batches. Use this option if the full sequences do not fit in memory. Alternatively, try reducing the number of sequences per mini-batch by setting the 'MiniBatchSize' option to a lower value.

To learn more about the effect of padding, truncating, and splitting the input sequences, see “Sequence Padding, Truncation, and Splitting”.

Example: 'SequenceLength', 'shortest'

### SequencePaddingDirection — Direction of padding or truncation

'right' (default) | 'left'

Direction of padding or truncation, specified as one of the following:

- `'right'` — Pad or truncate sequences on the right. The sequences start at the same time step and the software truncates or adds padding to the end of the sequences.
- `'left'` — Pad or truncate sequences on the left. The software truncates or adds padding to the start of the sequences so that the sequences end at the same time step.

Because LSTM layers process sequence data one time step at a time, when the layer `OutputMode` property is `'last'`, any padding in the final time steps can negatively influence the layer output. To pad or truncate sequence data on the left, set the `'SequencePaddingDirection'` option to `'left'`.

For sequence-to-sequence networks (when the `OutputMode` property is `'sequence'` for each LSTM layer), any padding in the first time steps can negatively influence the predictions for the earlier time steps. To pad or truncate sequence data on the right, set the `'SequencePaddingDirection'` option to `'right'`.

To learn more about the effect of padding, truncating, and splitting the input sequences, see “Sequence Padding, Truncation, and Splitting”.

### **SequencePaddingValue — Value to pad input sequences**

0 (default) | scalar

Value by which to pad input sequences, specified as a scalar. The option is valid only when `SequenceLength` is `'longest'` or a positive integer. Do not pad sequences with NaN, because doing so can propagate errors throughout the network.

Example: `'SequencePaddingValue', -1`

### **Hardware Options**

#### **ExecutionEnvironment — Hardware resource for training network**

`'auto'` (default) | `'cpu'` | `'gpu'` | `'multi-gpu'` | `'parallel'`

Hardware resource for training network, specified as one of the following:

- `'auto'` — Use a GPU if one is available. Otherwise, use the CPU.
- `'cpu'` — Use the CPU.
- `'gpu'` — Use the GPU.
- `'multi-gpu'` — Use multiple GPUs on one machine, using a local parallel pool based on your default cluster profile. If there is no current parallel pool, the software starts a parallel pool with pool size equal to the number of available GPUs.
- `'parallel'` — Use a local or remote parallel pool based on your default cluster profile. If there is no current parallel pool, the software starts one using the default cluster profile. If the pool has access to GPUs, then only workers with a unique GPU perform training computation. If the pool does not have GPUs, then training takes place on all available CPU workers instead.

For more information on when to use the different execution environments, see “Scale Up Deep Learning in Parallel and in the Cloud”.

GPU, multi-GPU, and parallel options require Parallel Computing Toolbox. To use a GPU for deep learning, you must also have a CUDA enabled NVIDIA GPU with compute capability 3.0 or higher. If you choose one of these options and Parallel Computing Toolbox or a suitable GPU is not available, then the software returns an error.

To see an improvement in performance when training in parallel, try scaling up the `MiniBatchSize` and `InitialLearnRate` training options by the number of GPUs.

Training long short-term memory networks supports single CPU or single GPU training only.

Datstores used for multi-GPU training or parallel training must be partitionable. For more information, see “Use Datastore for Parallel Training and Background Dispatching”.

If you use the `'multi-gpu'` option with a partitionable input datastore and the `'DispatchInBackground'` option, then the software starts a parallel pool with size equal to the default pool size. Workers with unique GPUs perform training computation. The remaining workers are used for background dispatch.

Example: `'ExecutionEnvironment','cpu'`

### **WorkerLoad — Parallel worker load division**

scalar from 0 to 1 | positive integer | numeric vector

Parallel worker load division between GPUs or CPUs, specified as the comma-separated pair consisting of `'WorkerLoad'` and one of the following:

- Scalar from 0 to 1 — Fraction of workers on each machine to use for network training computation. If you train the network using data in a mini-batch datastore with background dispatch enabled, then the remaining workers fetch and preprocess data in the background.
- Positive integer — Number of workers on each machine to use for network training computation. If you train the network using data in a mini-batch datastore with background dispatch enabled, then the remaining workers fetch and preprocess data in the background.
- Numeric vector — Network training load for each worker in the parallel pool. For a vector  $W$ , worker  $i$  gets a fraction  $W(i)/\text{sum}(W)$  of the work (number of examples per mini-batch). If you train a network using data in a mini-batch datastore with background dispatch enabled, then you can assign a worker load of 0 to use that worker for fetching data in the background. The specified vector must contain one value per worker in the parallel pool.

If the parallel pool has access to GPUs, then workers without a unique GPU are never used for training computation. The default for pools with GPUs is to use all workers with a unique GPU for training computation, and the remaining workers for background dispatch. If the pool does not have access to GPUs and CPUs are used for training, then the default is to use one worker per machine for background data dispatch.

### **DispatchInBackground — Use background dispatch**

false (default) | true

Use background dispatch (asynchronous prefetch queuing) to read training data from datstores, specified as `false` or `true`. Background dispatch requires Parallel Computing Toolbox.

`DispatchInBackground` is only supported for datstores that are partitionable. For more information, see “Use Datastore for Parallel Training and Background Dispatching”.

### **Checkpoints**

#### **CheckpointPath — Path for saving checkpoint networks**

' ' (default) | character vector

Path for saving the checkpoint networks, specified as the comma-separated pair consisting of `'CheckpointPath'` and a character vector.



- If you do not specify a path (that is, you use the default ' '), then the software does not save any checkpoint networks.
- If you specify a path, then `trainNetwork` saves checkpoint networks to this path after every epoch and assigns a unique name to each network. You can then load any checkpoint network and resume training from that network.

If the folder does not exist, then you must first create it before specifying the path for saving the checkpoint networks. If the path you specify does not exist, then `trainingOptions` returns an error.

For more information about saving network checkpoints, see “Save Checkpoint Networks and Resume Training”.

Example: 'CheckpointPath', 'C:\Temp\checkpoint'

Data Types: char

### OutputFcn — Output functions

function handle | cell array of function handles

Output functions to call during training, specified as the comma-separated pair consisting of 'OutputFcn' and a function handle or cell array of function handles. `trainNetwork` calls the specified functions once before the start of training, after each iteration, and once after training has finished. `trainNetwork` passes a structure containing information in the following fields:

Field	Description
Epoch	Current epoch number
Iteration	Current iteration number
TimeSinceStart	Time in seconds since the start of training
TrainingLoss	Current mini-batch loss
ValidationLoss	Loss on the validation data
BaseLearnRate	Current base learning rate
TrainingAccuracy	Accuracy on the current mini-batch (classification networks)
TrainingRMSE	RMSE on the current mini-batch (regression networks)
ValidationAccuracy	Accuracy on the validation data (classification networks)
ValidationRMSE	RMSE on the validation data (regression networks)
State	Current training state, with a possible value of "start", "iteration", or "done"

If a field is not calculated or relevant for a certain call to the output functions, then that field contains an empty array.

You can use output functions to display or plot progress information, or to stop training. To stop training early, make your output function return `true`. If any output function returns `true`, then training finishes and `trainNetwork` returns the latest network. For an example showing how to use output functions, see “Customize Output During Deep Learning Network Training”.

Data Types: `function_handle` | `cell`

## Output Arguments

### options — Training options

`TrainingOptionsSGDM` | `TrainingOptionsRMSProp` | `TrainingOptionsADAM`

Training options, returned as a `TrainingOptionsSGDM`, `TrainingOptionsRMSProp`, or `TrainingOptionsADAM` object. To train a neural network, use the training options as an input argument to the `trainNetwork` function.

If `solverName` equals `'sgdm'`, `'rmsprop'`, or `'adam'`, then the training options are returned as a `TrainingOptionsSGDM`, `TrainingOptionsRMSProp`, or `TrainingOptionsADAM` object, respectively.

You can edit training option properties of `TrainingOptionsSGDM`, `TrainingOptionsADAM`, and `TrainingOptionsRMSProp` objects directly. For example, to change the mini-batch size after using the `trainingOptions` function, you can edit the `MiniBatchSize` property directly:

```
options = trainingOptions('sgdm');  
options.MiniBatchSize = 64;
```

## Tips

- For most deep learning tasks, you can use a pretrained network and adapt it to your own data. For an example showing how to use transfer learning to retrain a convolutional neural network to classify a new set of images, see “Train Deep Learning Network to Classify New Images”. Alternatively, you can create and train networks from scratch using `layerGraph` objects with the `trainNetwork` and `trainingOptions` functions.

If the `trainingOptions` function does not provide the training options that you need for your task, then you can create a custom training loop using automatic differentiation. To learn more, see “Define Custom Training Loops”.

## Algorithms

### Initial Weights and Biases

For convolutional and fully connected layers, the initialization for the weights and biases are given by the `WeightsInitializer` and `BiasInitializer` properties of the layers, respectively. For examples showing how to change the initialization for the weights and biases, see “Specify Initial Weights and Biases in Convolutional Layer” on page 1-221 and “Specify Initial Weights and Biases in Fully Connected Layer” on page 1-398.

### Stochastic Gradient Descent

The standard gradient descent algorithm updates the network parameters (weights and biases) to minimize the loss function by taking small steps at each iteration in the direction of the negative gradient of the loss,

$$\theta_{\ell+1} = \theta_{\ell} - \alpha \nabla E(\theta_{\ell}),$$

where  $\ell$  is the iteration number,  $\alpha > 0$  is the learning rate,  $\theta$  is the parameter vector, and  $E(\theta)$  is the loss function. In the standard gradient descent algorithm, the gradient of the loss function,  $\nabla E(\theta)$ , is

evaluated using the entire training set, and the standard gradient descent algorithm uses the entire data set at once.

By contrast, at each iteration the *stochastic* gradient descent algorithm evaluates the gradient and updates the parameters using a subset of the training data. A different subset, called a mini-batch, is used at each iteration. The full pass of the training algorithm over the entire training set using mini-batches is one *epoch*. Stochastic gradient descent is stochastic because the parameter updates computed using a mini-batch is a noisy estimate of the parameter update that would result from using the full data set. You can specify the mini-batch size and the maximum number of epochs by using the 'MiniBatchSize' and 'MaxEpochs' name-value pair arguments, respectively.

### Stochastic Gradient Descent with Momentum

The stochastic gradient descent algorithm can oscillate along the path of steepest descent towards the optimum. Adding a momentum term to the parameter update is one way to reduce this oscillation [2]. The stochastic gradient descent with momentum (SGDM) update is

$$\theta_{\ell+1} = \theta_{\ell} - \alpha \nabla E(\theta_{\ell}) + \gamma(\theta_{\ell} - \theta_{\ell-1}),$$

where  $\gamma$  determines the contribution of the previous gradient step to the current iteration. You can specify this value using the 'Momentum' name-value pair argument. To train a neural network using the stochastic gradient descent with momentum algorithm, specify `solverName` as 'sgdm'. To specify the initial value of the learning rate  $\alpha$ , use the 'InitialLearnRate' name-value pair argument. You can also specify different learning rates for different layers and parameters. For more information, see "Set Up Parameters in Convolutional and Fully Connected Layers".

### RMSProp

Stochastic gradient descent with momentum uses a single learning rate for all the parameters. Other optimization algorithms seek to improve network training by using learning rates that differ by parameter and can automatically adapt to the loss function being optimized. RMSProp (root mean square propagation) is one such algorithm. It keeps a moving average of the element-wise squares of the parameter gradients,

$$v_{\ell} = \beta_2 v_{\ell-1} + (1 - \beta_2) [\nabla E(\theta_{\ell})]^2$$

$\beta_2$  is the decay rate of the moving average. Common values of the decay rate are 0.9, 0.99, and 0.999. The corresponding averaging lengths of the squared gradients equal  $1/(1-\beta_2)$ , that is, 10, 100, and 1000 parameter updates, respectively. You can specify  $\beta_2$  by using the 'SquaredGradientDecayFactor' name-value pair argument. The RMSProp algorithm uses this moving average to normalize the updates of each parameter individually,

$$\theta_{\ell+1} = \theta_{\ell} - \frac{\alpha \nabla E(\theta_{\ell})}{\sqrt{v_{\ell} + \epsilon}}$$

where the division is performed element-wise. Using RMSProp effectively decreases the learning rates of parameters with large gradients and increases the learning rates of parameters with small gradients.  $\epsilon$  is a small constant added to avoid division by zero. You can specify  $\epsilon$  by using the 'Epsilon' name-value pair argument, but the default value usually works well. To use RMSProp to train a neural network, specify `solverName` as 'rmsprop'.

**Adam**

Adam (derived from *adaptive moment estimation*) [4] uses a parameter update that is similar to RMSProp, but with an added momentum term. It keeps an element-wise moving average of both the parameter gradients and their squared values,

$$m_\ell = \beta_1 m_{\ell-1} + (1 - \beta_1) \nabla E(\theta_\ell)$$

$$v_\ell = \beta_2 v_{\ell-1} + (1 - \beta_2) [\nabla E(\theta_\ell)]^2$$

You can specify the  $\beta_1$  and  $\beta_2$  decay rates using the 'GradientDecayFactor' and 'SquaredGradientDecayFactor' name-value pair arguments, respectively. Adam uses the moving averages to update the network parameters as

$$\theta_{\ell+1} = \theta_\ell - \frac{\alpha m_\ell}{\sqrt{v_\ell} + \epsilon}$$

If gradients over many iterations are similar, then using a moving average of the gradient enables the parameter updates to pick up momentum in a certain direction. If the gradients contain mostly noise, then the moving average of the gradient becomes smaller, and so the parameter updates become smaller too. You can specify  $\epsilon$  by using the 'Epsilon' name-value pair argument. The default value usually works well, but for certain problems a value as large as 1 works better. To use Adam to train a neural network, specify `solverName` as 'adam'. The full Adam update also includes a mechanism to correct a bias that appears in the beginning of training. For more information, see [4].

Specify the learning rate  $\alpha$  for all optimization algorithms using the 'InitialLearnRate' name-value pair argument. The effect of the learning rate is different for the different optimization algorithms, so the optimal learning rates are also different in general. You can also specify learning rates that differ by layers and by parameter. For more information, see “Set Up Parameters in Convolutional and Fully Connected Layers”.

**Gradient Clipping**

If the gradients increase in magnitude exponentially, then the training is unstable and can diverge within a few iterations. This “gradient explosion” is indicated by a training loss that goes to NaN or Inf. Gradient clipping helps prevent gradient explosion by stabilizing the training at higher learning rates and in the presence of outliers [3]. Gradient clipping enables networks to be trained faster, and does not usually impact the accuracy of the learned task.

There are two types of gradient clipping.

- Norm-based gradient clipping rescales the gradient based on a threshold, and does not change the direction of the gradient. The 'l2norm' and 'global-l2norm' values of `GradientThresholdMethod` are norm-based gradient clipping methods.
- Value-based gradient clipping clips any partial derivative greater than the threshold, which can result in the gradient arbitrarily changing direction. Value-based gradient clipping can have unpredictable behavior, but sufficiently small changes do not cause the network to diverge. The 'absolute-value' value of `GradientThresholdMethod` is a value-based gradient clipping method.

For examples, see “Time Series Forecasting Using Deep Learning” and “Sequence-to-Sequence Classification Using Deep Learning”.

## L<sub>2</sub> Regularization

Adding a regularization term for the weights to the loss function  $E(\theta)$  is one way to reduce overfitting [1], [2]. The regularization term is also called *weight decay*. The loss function with the regularization term takes the form

$$E_R(\theta) = E(\theta) + \lambda\Omega(w),$$

where  $w$  is the weight vector,  $\lambda$  is the regularization factor (coefficient), and the regularization function  $\Omega(w)$  is

$$\Omega(w) = \frac{1}{2}w^T w.$$

Note that the biases are not regularized [2]. You can specify the regularization factor  $\lambda$  by using the 'L2Regularization' name-value pair argument. You can also specify different regularization factors for different layers and parameters. For more information, see “Set Up Parameters in Convolutional and Fully Connected Layers”.

The loss function that the software uses for network training includes the regularization term. However, the loss value displayed in the command window and training progress plot during training is the loss on the data only and does not include the regularization term.

## Compatibility Considerations

### 'ValidationPatience' training option default is Inf

*Behavior changed in R2018b*

Starting in R2018b, the default value of the 'ValidationPatience' training option is Inf, which means that automatic stopping via validation is turned off. This behavior prevents the training from stopping before sufficiently learning from the data.

In previous versions, the default value is 5. To reproduce this behavior, set the 'ValidationPatience' option to 5.

### Different file name for checkpoint networks

*Behavior changed in R2018b*

Starting in R2018b, when saving checkpoint networks, the software assigns file names beginning with `net_checkpoint_`. In previous versions, the software assigns file names beginning with `convnet_checkpoint_`.

If you have code that saves and loads checkpoint networks, then update your code to load files with the new name.

## References

- [1] Bishop, C. M. *Pattern Recognition and Machine Learning*. Springer, New York, NY, 2006.
- [2] Murphy, K. P. *Machine Learning: A Probabilistic Perspective*. The MIT Press, Cambridge, Massachusetts, 2012.

[3] Pascanu, R., T. Mikolov, and Y. Bengio. "On the difficulty of training recurrent neural networks". *Proceedings of the 30th International Conference on Machine Learning*. Vol. 28(3), 2013, pp. 1310-1318.

[4] Kingma, Diederik, and Jimmy Ba. "Adam: A method for stochastic optimization." *arXiv preprint arXiv:1412.6980* (2014).

## **See Also**

**Deep Network Designer** | `analyzeNetwork` | `trainNetwork`

### **Topics**

"Create Simple Deep Learning Network for Classification"

"Transfer Learning Using AlexNet"

"Resume Training from Checkpoint Network"

"Deep Learning with Big Data on CPUs, GPUs, in Parallel, and on the Cloud"

"Specify Layers of Convolutional Neural Network"

"Set Up Parameters and Train Convolutional Neural Network"

"Define Custom Training Loops, Loss Functions, and Networks"

**Introduced in R2016a**

# TrainingOptionsADAM

Training options for Adam optimizer

## Description

Training options for Adam (adaptive moment estimation) optimizer, including learning rate information,  $L_2$  regularization factor, and mini-batch size.

## Creation

Create a `TrainingOptionsADAM` object using `trainingOptions` and specifying 'adam' as the `solverName` input argument.

## Properties

### Plots and Display

#### Plots — Plots to display during network training

'none' | 'training-progress'

Plots to display during network training, specified as one of the following:

- 'none' — Do not display plots during training.
- 'training-progress' — Plot training progress. The plot shows mini-batch loss and accuracy, validation loss and accuracy, and additional information on the training progress. The plot has a stop button  in the top-right corner. Click the button to stop training and return the current state of the network.

#### Verbose — Indicator to display training progress information

1 | 0

Indicator to display training progress information in the command window, specified as 1 (true) or 0 (false).

The displayed information includes the epoch number, iteration number, time elapsed, mini-batch loss, mini-batch accuracy, and base learning rate. When you train a regression network, root mean square error (RMSE) is shown instead of accuracy. If you validate the network during training, then the displayed information also includes the validation loss and validation accuracy (or RMSE).

Data Types: `logical`

#### VerboseFrequency — Frequency of verbose printing

positive integer

Frequency of verbose printing, which is the number of iterations between printing to the command window, specified as a positive integer. This property only has an effect when the `Verbose` value equals `true`.

If you validate the network during training, then `trainNetwork` prints to the command window every time validation occurs.

### Mini-Batch Options

#### MaxEpochs — Maximum number of epochs

positive integer

Maximum number of epochs to use for training, specified as a positive integer.

An iteration is one step taken in the gradient descent algorithm towards minimizing the loss function using a mini-batch. An epoch is the full pass of the training algorithm over the entire training set.

#### MiniBatchSize — Size of mini-batch

positive integer

Size of the mini-batch to use for each training iteration, specified as a positive integer. A mini-batch is a subset of the training set that is used to evaluate the gradient of the loss function and update the weights.

#### Shuffle — Option for data shuffling

'once' | 'never' | 'every-epoch'

Option for data shuffling, specified as one of the following:

- 'once' — Shuffle the training and validation data once before training.
- 'never' — Do not shuffle the data.
- 'every-epoch' — Shuffle the training data before each training epoch, and shuffle the validation data before each network validation. If the mini-batch size does not evenly divide the number of training samples, then `trainNetwork` discards the training data that does not fit into the final complete mini-batch of each epoch. Set the `Shuffle` value to 'every-epoch' to avoid discarding the same data every epoch.

### Validation

#### ValidationData — Data to use for validation during training

image datastore | datastore | table | cell array

Data to use for validation during training, specified as an image datastore, a datastore that returns data in a two-column table or two-column cell array, a table, or a cell array. The format of the validation data depends on the type of task and correspond to valid inputs to the `trainNetwork` function.

This option supports networks with a single input only.

#### Image Data

For image data, specify the validation data as one of the following:

Input	Description	More Information
Image datastore	ImageDatastore object with categorical labels.	imds argument of <code>trainNetwork</code>



Input		Description	More Information
Datastore		Datastore that returns data in a two-column table or two-column cell array, where the two columns specify the network inputs and expected responses, respectively.	ds argument of <code>trainNetwork</code>
Table		Table, where the first column contains either image paths or images, and the subsequent columns contain the responses.	tbl argument of <code>trainNetwork</code>
Cell array {X,Y}	X	Numeric array of images.	X argument of <code>trainNetwork</code>
	Y	Categorical vector of labels, matrix of numeric responses, or array of images.	Y argument of <code>trainNetwork</code>

### Sequence and Time Series Data

For sequence and time series data, specify the validation data as one of the following:

Input		Description	More Information
Cell array {sequences,Y}	sequences	Cell array of sequences or time series data.	sequences argument of <code>trainNetwork</code>
	Y	Categorical vector of labels, cell array of categorical sequences, matrix of numeric responses, or cell array of numeric sequences.	Y argument of <code>trainNetwork</code>
Table		Table containing absolute or relative file paths to a MAT files containing sequence or time series data.	tbl argument of <code>trainNetwork</code>

During training, `trainNetwork` calculates the validation accuracy and validation loss on the validation data. To specify the validation frequency, use the 'ValidationFrequency' name-value pair argument. You can also use the validation data to stop training automatically when the validation loss stops decreasing. To turn on automatic validation stopping, use the 'ValidationPatience' name-value pair argument.

If your network has layers that behave differently during prediction than during training (for example, dropout layers), then the validation accuracy can be higher than the training (mini-batch) accuracy.

The validation data is shuffled according to the 'Shuffle' value. If the 'Shuffle' value equals 'every-epoch', then the validation data is shuffled before each network validation.

**ValidationFrequency — Frequency of network validation**

positive integer

Frequency of network validation in number of iterations, specified as a positive integer.

The `ValidationFrequency` value is the number of iterations between evaluations of validation metrics.

**ValidationPatience — Patience of validation stopping**

positive integer | Inf

Patience of validation stopping of network training, specified as a positive integer or Inf.

The 'ValidationPatience' value is the number of times that the loss on the validation set can be larger than or equal to the previously smallest loss before network training stops.

**Solver Options****InitialLearnRate — Initial learning rate**

positive scalar

Initial learning rate used for training, specified as a positive scalar. If the learning rate is too low, then training takes a long time. If the learning rate is too high, then training can reach a suboptimal result.

**LearnRateScheduleSettings — Settings for learning rate schedule**

structure

Settings for the learning rate schedule, specified as a structure. `LearnRateScheduleSettings` has the field `Method`, which specifies the type of method for adjusting the learning rate. The possible methods are:

- 'none' — The learning rate is constant throughout training.
- 'piecewise' — The learning rate drops periodically during training.

If `Method` is 'piecewise', then `LearnRateScheduleSettings` contains two more fields:

- `DropRateFactor` — The multiplicative factor by which the learning rate drops during training
- `DropPeriod` — The number of epochs that passes between adjustments to the learning rate during training

Specify the settings for the learning schedule rate using `trainingOptions`.

Data Types: `struct`

**L2Regularization — Factor for L<sub>2</sub> regularizer**

nonnegative scalar

Factor for L<sub>2</sub> regularizer (weight decay), specified as a nonnegative scalar.

You can specify a multiplier for the L<sub>2</sub> regularizer for network layers with learnable parameters.

**GradientDecayFactor — Decay rate of gradient moving average**

scalar from 0 to 1

Decay rate of gradient moving average, specified as a scalar from 0 to 1. For more information about the different solvers, see “Stochastic Gradient Descent” on page 1-800.

**SquaredGradientDecayFactor — Decay rate of squared gradient moving average**

scalar from 0 to 1

Decay rate of squared gradient moving average, specified as a scalar from 0 to 1. For more information about the different solvers, see “Stochastic Gradient Descent” on page 1-800.

**Epsilon — Denominator offset**

positive scalar

Denominator offset, specified as a positive scalar. The solver adds the offset to the denominator in the network parameter updates to avoid division by zero.

**ResetInputNormalization — Option to reset input layer normalization**

true (default) | false

Option to reset input layer normalization, specified as one of the following:

- true - Reset the input layer normalization statistics and recalculate them at training time.
- false - Calculate normalization statistics at training time when they are empty.

**Gradient Clipping****GradientThreshold — Gradient threshold**

positive scalar | Inf

Positive threshold for the gradient, specified as positive scalar or Inf. When the gradient exceeds the value of GradientThreshold, then the gradient is clipped according to GradientThresholdMethod.

**GradientThresholdMethod — Gradient threshold method**

'l2norm' | 'global-l2norm' | 'absolutevalue'

Gradient threshold method used to clip gradient values that exceed the gradient threshold, specified as one of the following:

- 'l2norm' — If the  $L_2$  norm of the gradient of a learnable parameter is larger than GradientThreshold, then scale the gradient so that the  $L_2$  norm equals GradientThreshold.
- 'global-l2norm' — If the global  $L_2$  norm,  $L$ , is larger than GradientThreshold, then scale all gradients by a factor of GradientThreshold/ $L$ . The global  $L_2$  norm considers all learnable parameters.
- 'absolute-value' — If the absolute value of an individual partial derivative in the gradient of a learnable parameter is larger than GradientThreshold, then scale the partial derivative to have magnitude equal to GradientThreshold and retain the sign of the partial derivative.

For more information, see Gradient Clipping on page 1-802.

## Sequence Options

### SequenceLength — Option to pad or truncate sequences

'longest' | 'shortest' | positive integer

Option to pad, truncate, or split input sequences, specified as one of the following:

- 'longest' — Pad sequences in each mini-batch to have the same length as the longest sequence. This option does not discard any data, though padding can introduce noise to the network.
- 'shortest' — Truncate sequences in each mini-batch to have the same length as the shortest sequence. This option ensures that no padding is added, at the cost of discarding data.
- Positive integer — For each mini-batch, pad the sequences to the nearest multiple of the specified length that is greater than the longest sequence length in the mini-batch, and then split the sequences into smaller sequences of the specified length. If splitting occurs, then the software creates extra mini-batches. Use this option if the full sequences do not fit in memory. Alternatively, try reducing the number of sequences per mini-batch by setting the 'MiniBatchSize' option to a lower value.

To learn more about the effect of padding, truncating, and splitting the input sequences, see “Sequence Padding, Truncation, and Splitting”.

### SequencePaddingDirection — Direction of padding or truncation

'right' (default) | 'left'

Direction of padding or truncation, specified as one of the following:

- 'right' — Pad or truncate sequences on the right. The sequences start at the same time step and the software truncates or adds padding to the end of the sequences.
- 'left' — Pad or truncate sequences on the left. The software truncates or adds padding to the start of the sequences so that the sequences end at the same time step.

Because LSTM layers process sequence data one time step at a time, when the layer `OutputMode` property is 'last', any padding in the final time steps can negatively influence the layer output. To pad or truncate sequence data on the left, set the 'SequencePaddingDirection' option to 'left'.

For sequence-to-sequence networks (when the `OutputMode` property is 'sequence' for each LSTM layer), any padding in the first time steps can negatively influence the predictions for the earlier time steps. To pad or truncate sequence data on the right, set the 'SequencePaddingDirection' option to 'right'.

To learn more about the effect of padding, truncating, and splitting the input sequences, see “Sequence Padding, Truncation, and Splitting”.

### SequencePaddingValue — Value to pad sequences

scalar

Value by which to pad input sequences, specified as a scalar. The option is valid only when `SequenceLength` is 'longest' or a positive integer. Do not pad sequences with NaN, because doing so can propagate errors throughout the network.

## Hardware Options

### ExecutionEnvironment — Hardware resource for training network

'auto' | 'cpu' | 'gpu' | 'multi-gpu' | 'parallel'

Hardware resource for training network, specified as one of the following:

- 'auto' — Use a GPU if one is available. Otherwise, use the CPU.
- 'cpu' — Use the CPU.
- 'gpu' — Use the GPU.
- 'multi-gpu' — Use multiple GPUs on one machine, using a local parallel pool based on your default cluster profile. If there is no current parallel pool, the software starts a parallel pool with pool size equal to the number of available GPUs.
- 'parallel' — Use a local or remote parallel pool based on your default cluster profile. If there is no current parallel pool, the software starts one using the default cluster profile. If the pool has access to GPUs, then only workers with a unique GPU perform training computation. If the pool does not have GPUs, then training takes place on all available CPU workers instead.

For more information on when to use the different execution environments, see “Scale Up Deep Learning in Parallel and in the Cloud”.

GPU, multi-GPU, and parallel options require Parallel Computing Toolbox. To use a GPU for deep learning, you must also have a CUDA enabled NVIDIA GPU with compute capability 3.0 or higher. If you choose one of these options and Parallel Computing Toolbox or a suitable GPU is not available, then the software returns an error.

To see an improvement in performance when training in parallel, try scaling up the `MiniBatchSize` and `InitialLearnRate` training options by the number of GPUs.

Training long short-term memory networks supports single CPU or single GPU training only.

Specify the execution environment using `trainingOptions`.

Data Types: char | string

### WorkerLoad — Parallel worker load division

scalar from 0 to 1 | positive integer | numeric vector

Worker load division for GPUs or CPUs, specified as a scalar from 0 to 1, a positive integer, or a numeric vector. This property has an effect only when the `ExecutionEnvironment` value equals 'multi-gpu' or 'parallel'.

## Checkpoints

### CheckpointPath — Path for saving checkpoint networks

character vector

Path where checkpoint networks are saved, specified as a character vector.

Data Types: char

### OutputFcn — Output functions

function handle | cell array of function handles

Output functions to call during training, specified as a function handle or cell array of function handles. `trainNetwork` calls the specified functions once before the start of training, after each iteration, and once after training has finished. `trainNetwork` passes a structure containing information in the following fields:

Field	Description
Epoch	Current epoch number
Iteration	Current iteration number
TimeSinceStart	Time in seconds since the start of training
TrainingLoss	Current mini-batch loss
ValidationLoss	Loss on the validation data
BaseLearnRate	Current base learning rate
TrainingAccuracy	Accuracy on the current mini-batch (classification networks)
TrainingRMSE	RMSE on the current mini-batch (regression networks)
ValidationAccuracy	Accuracy on the validation data (classification networks)
ValidationRMSE	RMSE on the validation data (regression networks)
State	Current training state, with a possible value of "start", "iteration", or "done".

If a field is not calculated or relevant for a certain call to the output functions, then that field contains an empty array.

You can use output functions to display or plot progress information, or to stop training. To stop training early, make your output function return `true`. If any output function returns `true`, then training finishes and `trainNetwork` returns the latest network. For an example showing how to use output functions, see “Customize Output During Deep Learning Network Training” .

Data Types: `function_handle` | `cell`

## Examples

### Create Training Options for the Adam Optimizer

Create a set of options for training a neural network using the Adam optimizer. Set the maximum number of epochs for training to 20, and use a mini-batch with 64 observations at each iteration. Specify the learning rate and the decay rate of the moving average of the squared gradient. Turn on the training progress plot.

```
options = trainingOptions('adam', ...
    'InitialLearnRate',3e-4, ...
    'SquaredGradientDecayFactor',0.99, ...
    'MaxEpochs',20, ...
    'MiniBatchSize',64, ...
    'Plots','training-progress')
```

```
options =
    TrainingOptionsADAM with properties:
```

```

    GradientDecayFactor: 0.9000
  SquaredGradientDecayFactor: 0.9900
    Epsilon: 1.0000e-08
    InitialLearnRate: 3.0000e-04
    LearnRateSchedule: 'none'
    LearnRateDropFactor: 0.1000
    LearnRateDropPeriod: 10
    L2Regularization: 1.0000e-04
  GradientThresholdMethod: 'l2norm'
    GradientThreshold: Inf
    MaxEpochs: 20
    MiniBatchSize: 64
    Verbose: 1
    VerboseFrequency: 50
    ValidationData: []
  ValidationFrequency: 50
  ValidationPatience: Inf
    Shuffle: 'once'
    CheckpointPath: ''
  ExecutionEnvironment: 'auto'
    WorkerLoad: []
    OutputFcn: []
    Plots: 'training-progress'
    SequenceLength: 'longest'
  SequencePaddingValue: 0
  SequencePaddingDirection: 'right'
  DispatchInBackground: 0
  ResetInputNormalization: 1

```

## References

- [1] Kingma, Diederik, and Jimmy Ba. "Adam: A method for stochastic optimization." *arXiv preprint arXiv:1412.6980* (2014).

## See Also

`trainNetwork` | `trainingOptions`

## Topics

- "Create Simple Deep Learning Network for Classification"
- "Transfer Learning Using AlexNet"
- "Resume Training from Checkpoint Network"
- "Deep Learning with Big Data on CPUs, GPUs, in Parallel, and on the Cloud"
- "Specify Layers of Convolutional Neural Network"
- "Set Up Parameters and Train Convolutional Neural Network"

## Introduced in R2018a

# TrainingOptionsRMSProp

Training options for RMSProp optimizer

## Description

Training options for RMSProp (root mean square propagation) optimizer, including learning rate information,  $L_2$  regularization factor, and mini-batch size.

## Creation

Create a `TrainingOptionsRMSProp` object using `trainingOptions` and specifying 'rmsprop' as the `solverName` input argument.

## Properties

### Plots and Display

#### Plots — Plots to display during network training

'none' | 'training-progress'

Plots to display during network training, specified as one of the following:

- 'none' — Do not display plots during training.
- 'training-progress' — Plot training progress. The plot shows mini-batch loss and accuracy, validation loss and accuracy, and additional information on the training progress. The plot has a stop button  in the top-right corner. Click the button to stop training and return the current state of the network.

#### Verbose — Indicator to display training progress information

1 | 0

Indicator to display training progress information in the command window, specified as 1 (true) or 0 (false).

The displayed information includes the epoch number, iteration number, time elapsed, mini-batch loss, mini-batch accuracy, and base learning rate. When you train a regression network, root mean square error (RMSE) is shown instead of accuracy. If you validate the network during training, then the displayed information also includes the validation loss and validation accuracy (or RMSE).

Data Types: `logical`

#### VerboseFrequency — Frequency of verbose printing

positive integer

Frequency of verbose printing, which is the number of iterations between printing to the command window, specified as a positive integer. This property only has an effect when the `Verbose` value equals `true`.



If you validate the network during training, then `trainNetwork` prints to the command window every time validation occurs.

### Mini-Batch Options

#### MaxEpochs — Maximum number of epochs

positive integer

Maximum number of epochs to use for training, specified as a positive integer.

An iteration is one step taken in the gradient descent algorithm towards minimizing the loss function using a mini-batch. An epoch is the full pass of the training algorithm over the entire training set.

#### MiniBatchSize — Size of mini-batch

positive integer

Size of the mini-batch to use for each training iteration, specified as a positive integer. A mini-batch is a subset of the training set that is used to evaluate the gradient of the loss function and update the weights.

#### Shuffle — Option for data shuffling

'once' | 'never' | 'every-epoch'

Option for data shuffling, specified as one of the following:

- 'once' — Shuffle the training and validation data once before training.
- 'never' — Do not shuffle the data.
- 'every-epoch' — Shuffle the training data before each training epoch, and shuffle the validation data before each network validation. If the mini-batch size does not evenly divide the number of training samples, then `trainNetwork` discards the training data that does not fit into the final complete mini-batch of each epoch. Set the `Shuffle` value to 'every-epoch' to avoid discarding the same data every epoch.

### Validation

#### ValidationData — Data to use for validation during training

image datastore | datastore | table | cell array

Data to use for validation during training, specified as an image datastore, a datastore that returns data in a two-column table or two-column cell array, a table, or a cell array. The format of the validation data depends on the type of task and correspond to valid inputs to the `trainNetwork` function.

This option supports networks with a single input only.

#### Image Data

For image data, specify the validation data as one of the following:

Input	Description	More Information
Image datastore	ImageDatastore object with categorical labels.	imds argument of <code>trainNetwork</code>

Input		Description	More Information
Datastore		Datastore that returns data in a two-column table or two-column cell array, where the two columns specify the network inputs and expected responses, respectively.	ds argument of <code>trainNetwork</code>
Table		Table, where the first column contains either image paths or images, and the subsequent columns contain the responses.	tbl argument of <code>trainNetwork</code>
Cell array {X,Y}	X	Numeric array of images.	X argument of <code>trainNetwork</code>
	Y	Categorical vector of labels, matrix of numeric responses, or array of images.	Y argument of <code>trainNetwork</code>

**Sequence and Time Series Data**

For sequence and time series data, specify the validation data as one of the following:

Input		Description	More Information
Cell array {sequences,Y}	sequences	Cell array of sequences or time series data.	sequences argument of <code>trainNetwork</code>
	Y	Categorical vector of labels, cell array of categorical sequences, matrix of numeric responses, or cell array of numeric sequences.	Y argument of <code>trainNetwork</code>
Table		Table containing absolute or relative file paths to a MAT files containing sequence or time series data.	tbl argument of <code>trainNetwork</code>

During training, `trainNetwork` calculates the validation accuracy and validation loss on the validation data. To specify the validation frequency, use the 'ValidationFrequency' name-value pair argument. You can also use the validation data to stop training automatically when the validation loss stops decreasing. To turn on automatic validation stopping, use the 'ValidationPatience' name-value pair argument.

If your network has layers that behave differently during prediction than during training (for example, dropout layers), then the validation accuracy can be higher than the training (mini-batch) accuracy.

The validation data is shuffled according to the 'Shuffle' value. If the 'Shuffle' value equals 'every-epoch', then the validation data is shuffled before each network validation.

### **ValidationFrequency — Frequency of network validation**

positive integer

Frequency of network validation in number of iterations, specified as a positive integer.

The ValidationFrequency value is the number of iterations between evaluations of validation metrics.

### **ValidationPatience — Patience of validation stopping**

positive integer | Inf

Patience of validation stopping of network training, specified as a positive integer or Inf.

The 'ValidationPatience' value is the number of times that the loss on the validation set can be larger than or equal to the previously smallest loss before network training stops.

## **Solver Options**

### **InitialLearnRate — Initial learning rate**

positive scalar

Initial learning rate used for training, specified as a positive scalar. If the learning rate is too low, then training takes a long time. If the learning rate is too high, then training can reach a suboptimal result.

### **LearnRateScheduleSettings — Settings for learning rate schedule**

structure

Settings for the learning rate schedule, specified as a structure. LearnRateScheduleSettings has the field Method, which specifies the type of method for adjusting the learning rate. The possible methods are:

- 'none' — The learning rate is constant throughout training.
- 'piecewise' — The learning rate drops periodically during training.

If Method is 'piecewise', then LearnRateScheduleSettings contains two more fields:

- DropRateFactor — The multiplicative factor by which the learning rate drops during training
- DropPeriod — The number of epochs that passes between adjustments to the learning rate during training

Specify the settings for the learning schedule rate using trainingOptions.

Data Types: struct

### **L2Regularization — Factor for L<sub>2</sub> regularizer**

nonnegative scalar

Factor for L<sub>2</sub> regularizer (weight decay), specified as a nonnegative scalar.

You can specify a multiplier for the L<sub>2</sub> regularizer for network layers with learnable parameters.

**SquaredGradientDecayFactor — Decay rate of squared gradient moving average**

scalar from 0 to 1

Decay rate of squared gradient moving average, specified as a scalar from 0 to 1. For more information about the different solvers, see “Stochastic Gradient Descent” on page 1-800.

**Epsilon — Denominator offset**

positive scalar

Denominator offset, specified as a positive scalar. The solver adds the offset to the denominator in the network parameter updates to avoid division by zero.

**ResetInputNormalization — Option to reset input layer normalization**

true (default) | false

Option to reset input layer normalization, specified as one of the following:

- true - Reset the input layer normalization statistics and recalculate them at training time.
- false - Calculate normalization statistics at training time when they are empty.

**Gradient Clipping****GradientThreshold — Gradient threshold**

positive scalar | Inf

Positive threshold for the gradient, specified as positive scalar or Inf. When the gradient exceeds the value of GradientThreshold, then the gradient is clipped according to GradientThresholdMethod.

**GradientThresholdMethod — Gradient threshold method**

'l2norm' | 'global-l2norm' | 'absolutevalue'

Gradient threshold method used to clip gradient values that exceed the gradient threshold, specified as one of the following:

- 'l2norm' — If the  $L_2$  norm of the gradient of a learnable parameter is larger than GradientThreshold, then scale the gradient so that the  $L_2$  norm equals GradientThreshold.
- 'global-l2norm' — If the global  $L_2$  norm,  $L$ , is larger than GradientThreshold, then scale all gradients by a factor of GradientThreshold/ $L$ . The global  $L_2$  norm considers all learnable parameters.
- 'absolute-value' — If the absolute value of an individual partial derivative in the gradient of a learnable parameter is larger than GradientThreshold, then scale the partial derivative to have magnitude equal to GradientThreshold and retain the sign of the partial derivative.

For more information, see Gradient Clipping on page 1-802.

**Sequence Options****SequenceLength — Option to pad or truncate sequences**

'longest' | 'shortest' | positive integer

Option to pad, truncate, or split input sequences, specified as one of the following:

- 'longest' — Pad sequences in each mini-batch to have the same length as the longest sequence. This option does not discard any data, though padding can introduce noise to the network.

- `'shortest'` — Truncate sequences in each mini-batch to have the same length as the shortest sequence. This option ensures that no padding is added, at the cost of discarding data.
- Positive integer — For each mini-batch, pad the sequences to the nearest multiple of the specified length that is greater than the longest sequence length in the mini-batch, and then split the sequences into smaller sequences of the specified length. If splitting occurs, then the software creates extra mini-batches. Use this option if the full sequences do not fit in memory. Alternatively, try reducing the number of sequences per mini-batch by setting the `'MiniBatchSize'` option to a lower value.

To learn more about the effect of padding, truncating, and splitting the input sequences, see “Sequence Padding, Truncation, and Splitting”.

### SequencePaddingDirection — Direction of padding or truncation

`'right'` (default) | `'left'`

Direction of padding or truncation, specified as one of the following:

- `'right'` — Pad or truncate sequences on the right. The sequences start at the same time step and the software truncates or adds padding to the end of the sequences.
- `'left'` — Pad or truncate sequences on the left. The software truncates or adds padding to the start of the sequences so that the sequences end at the same time step.

Because LSTM layers process sequence data one time step at a time, when the layer `OutputMode` property is `'last'`, any padding in the final time steps can negatively influence the layer output. To pad or truncate sequence data on the left, set the `'SequencePaddingDirection'` option to `'left'`.

For sequence-to-sequence networks (when the `OutputMode` property is `'sequence'` for each LSTM layer), any padding in the first time steps can negatively influence the predictions for the earlier time steps. To pad or truncate sequence data on the right, set the `'SequencePaddingDirection'` option to `'right'`.

To learn more about the effect of padding, truncating, and splitting the input sequences, see “Sequence Padding, Truncation, and Splitting”.

### SequencePaddingValue — Value to pad sequences

scalar

Value by which to pad input sequences, specified as a scalar. The option is valid only when `SequenceLength` is `'longest'` or a positive integer. Do not pad sequences with NaN, because doing so can propagate errors throughout the network.

## Hardware Options

### ExecutionEnvironment — Hardware resource for training network

`'auto'` | `'cpu'` | `'gpu'` | `'multi-gpu'` | `'parallel'`

Hardware resource for training network, specified as one of the following:

- `'auto'` — Use a GPU if one is available. Otherwise, use the CPU.
- `'cpu'` — Use the CPU.
- `'gpu'` — Use the GPU.

- 'multi-gpu' — Use multiple GPUs on one machine, using a local parallel pool based on your default cluster profile. If there is no current parallel pool, the software starts a parallel pool with pool size equal to the number of available GPUs.
- 'parallel' — Use a local or remote parallel pool based on your default cluster profile. If there is no current parallel pool, the software starts one using the default cluster profile. If the pool has access to GPUs, then only workers with a unique GPU perform training computation. If the pool does not have GPUs, then training takes place on all available CPU workers instead.

For more information on when to use the different execution environments, see “Scale Up Deep Learning in Parallel and in the Cloud”.

GPU, multi-GPU, and parallel options require Parallel Computing Toolbox. To use a GPU for deep learning, you must also have a CUDA enabled NVIDIA GPU with compute capability 3.0 or higher. If you choose one of these options and Parallel Computing Toolbox or a suitable GPU is not available, then the software returns an error.

To see an improvement in performance when training in parallel, try scaling up the `MiniBatchSize` and `InitialLearnRate` training options by the number of GPUs.

Training long short-term memory networks supports single CPU or single GPU training only.

Specify the execution environment using `trainingOptions`.

Data Types: char | string

#### **WorkerLoad — Parallel worker load division**

scalar from 0 to 1 | positive integer | numeric vector

Worker load division for GPUs or CPUs, specified as a scalar from 0 to 1, a positive integer, or a numeric vector. This property has an effect only when the `ExecutionEnvironment` value equals 'multi-gpu' or 'parallel'.

#### **Checkpoints**

##### **CheckpointPath — Path for saving checkpoint networks**

character vector

Path where checkpoint networks are saved, specified as a character vector.

Data Types: char

##### **OutputFcn — Output functions**

function handle | cell array of function handles

Output functions to call during training, specified as a function handle or cell array of function handles. `trainNetwork` calls the specified functions once before the start of training, after each iteration, and once after training has finished. `trainNetwork` passes a structure containing information in the following fields:

Field	Description
Epoch	Current epoch number
Iteration	Current iteration number
TimeSinceStart	Time in seconds since the start of training

Field	Description
TrainingLoss	Current mini-batch loss
ValidationLoss	Loss on the validation data
BaseLearnRate	Current base learning rate
TrainingAccuracy	Accuracy on the current mini-batch (classification networks)
TrainingRMSE	RMSE on the current mini-batch (regression networks)
ValidationAccuracy	Accuracy on the validation data (classification networks)
ValidationRMSE	RMSE on the validation data (regression networks)
State	Current training state, with a possible value of "start", "iteration", or "done".

If a field is not calculated or relevant for a certain call to the output functions, then that field contains an empty array.

You can use output functions to display or plot progress information, or to stop training. To stop training early, make your output function return `true`. If any output function returns `true`, then training finishes and `trainNetwork` returns the latest network. For an example showing how to use output functions, see “Customize Output During Deep Learning Network Training” .

Data Types: `function_handle` | `cell`

## Examples

### Create Training Options for the RMSProp Optimizer

Create a set of options for training a neural network using the RMSProp optimizer. Set the maximum number of epochs for training to 20, and use a mini-batch with 64 observations at each iteration. Specify the learning rate and the decay rate of the moving average of the squared gradient. Turn on the training progress plot.

```
options = trainingOptions('rmsprop', ...
    'InitialLearnRate',3e-4, ...
    'SquaredGradientDecayFactor',0.99, ...
    'MaxEpochs',20, ...
    'MiniBatchSize',64, ...
    'Plots','training-progress')
```

```
options =
    TrainingOptionsRMSProp with properties:

        SquaredGradientDecayFactor: 0.9900
                Epsilon: 1.0000e-08
        InitialLearnRate: 3.0000e-04
        LearnRateSchedule: 'none'
        LearnRateDropFactor: 0.1000
        LearnRateDropPeriod: 10
                L2Regularization: 1.0000e-04
        GradientThresholdMethod: 'l2norm'
```

```
GradientThreshold: Inf
  MaxEpochs: 20
  MiniBatchSize: 64
  Verbose: 1
  VerboseFrequency: 50
  ValidationData: []
ValidationFrequency: 50
ValidationPatience: Inf
  Shuffle: 'once'
  CheckpointPath: ''
ExecutionEnvironment: 'auto'
  WorkerLoad: []
  OutputFcn: []
  Plots: 'training-progress'
  SequenceLength: 'longest'
SequencePaddingValue: 0
SequencePaddingDirection: 'right'
DispatchInBackground: 0
ResetInputNormalization: 1
```

## See Also

[trainNetwork](#) | [trainingOptions](#)

## Topics

“Create Simple Deep Learning Network for Classification”

“Transfer Learning Using AlexNet”

“Resume Training from Checkpoint Network”

“Deep Learning with Big Data on CPUs, GPUs, in Parallel, and on the Cloud”

“Specify Layers of Convolutional Neural Network”

“Set Up Parameters and Train Convolutional Neural Network”

**Introduced in R2018a**



# TrainingOptionsSGDM

Training options for stochastic gradient descent with momentum

## Description

Training options for stochastic gradient descent with momentum, including learning rate information,  $L_2$  regularization factor, and mini-batch size.

## Creation

Create a `TrainingOptionsSGDM` object using `trainingOptions` and specifying 'sgdm' as the `solverName` input argument.

## Properties

### Plots and Display

#### Plots — Plots to display during network training

'none' | 'training-progress'

Plots to display during network training, specified as one of the following:

- 'none' — Do not display plots during training.
- 'training-progress' — Plot training progress. The plot shows mini-batch loss and accuracy, validation loss and accuracy, and additional information on the training progress. The plot has a stop button  in the top-right corner. Click the button to stop training and return the current state of the network.

#### Verbose — Indicator to display training progress information

1 | 0

Indicator to display training progress information in the command window, specified as 1 (true) or 0 (false).

The displayed information includes the epoch number, iteration number, time elapsed, mini-batch loss, mini-batch accuracy, and base learning rate. When you train a regression network, root mean square error (RMSE) is shown instead of accuracy. If you validate the network during training, then the displayed information also includes the validation loss and validation accuracy (or RMSE).

Data Types: `logical`

#### VerboseFrequency — Frequency of verbose printing

positive integer

Frequency of verbose printing, which is the number of iterations between printing to the command window, specified as a positive integer. This property only has an effect when the `Verbose` value equals `true`.

If you validate the network during training, then `trainNetwork` prints to the command window every time validation occurs.

### Mini-Batch Options

#### MaxEpochs — Maximum number of epochs

positive integer

Maximum number of epochs to use for training, specified as a positive integer.

An iteration is one step taken in the gradient descent algorithm towards minimizing the loss function using a mini-batch. An epoch is the full pass of the training algorithm over the entire training set.

#### MiniBatchSize — Size of mini-batch

positive integer

Size of the mini-batch to use for each training iteration, specified as a positive integer. A mini-batch is a subset of the training set that is used to evaluate the gradient of the loss function and update the weights.

#### Shuffle — Option for data shuffling

'once' | 'never' | 'every-epoch'

Option for data shuffling, specified as one of the following:

- 'once' — Shuffle the training and validation data once before training.
- 'never' — Do not shuffle the data.
- 'every-epoch' — Shuffle the training data before each training epoch, and shuffle the validation data before each network validation. If the mini-batch size does not evenly divide the number of training samples, then `trainNetwork` discards the training data that does not fit into the final complete mini-batch of each epoch. Set the `Shuffle` value to 'every-epoch' to avoid discarding the same data every epoch.

### Validation

#### ValidationData — Data to use for validation during training

image datastore | datastore | table | cell array

Data to use for validation during training, specified as an image datastore, a datastore that returns data in a two-column table or two-column cell array, a table, or a cell array. The format of the validation data depends on the type of task and correspond to valid inputs to the `trainNetwork` function.

This option supports networks with a single input only.

#### Image Data

For image data, specify the validation data as one of the following:

Input	Description	More Information
Image datastore	ImageDatastore object with categorical labels.	imds argument of <code>trainNetwork</code>

Input		Description	More Information
Datastore		Datastore that returns data in a two-column table or two-column cell array, where the two columns specify the network inputs and expected responses, respectively.	ds argument of <code>trainNetwork</code>
Table		Table, where the first column contains either image paths or images, and the subsequent columns contain the responses.	tbl argument of <code>trainNetwork</code>
Cell array {X,Y}	X	Numeric array of images.	X argument of <code>trainNetwork</code>
	Y	Categorical vector of labels, matrix of numeric responses, or array of images.	Y argument of <code>trainNetwork</code>

### Sequence and Time Series Data

For sequence and time series data, specify the validation data as one of the following:

Input		Description	More Information
Cell array {sequences,Y}	sequences	Cell array of sequences or time series data.	sequences argument of <code>trainNetwork</code>
	Y	Categorical vector of labels, cell array of categorical sequences, matrix of numeric responses, or cell array of numeric sequences.	Y argument of <code>trainNetwork</code>
Table		Table containing absolute or relative file paths to a MAT files containing sequence or time series data.	tbl argument of <code>trainNetwork</code>

During training, `trainNetwork` calculates the validation accuracy and validation loss on the validation data. To specify the validation frequency, use the 'ValidationFrequency' name-value pair argument. You can also use the validation data to stop training automatically when the validation loss stops decreasing. To turn on automatic validation stopping, use the 'ValidationPatience' name-value pair argument.

If your network has layers that behave differently during prediction than during training (for example, dropout layers), then the validation accuracy can be higher than the training (mini-batch) accuracy.

The validation data is shuffled according to the 'Shuffle' value. If the 'Shuffle' value equals 'every-epoch', then the validation data is shuffled before each network validation.

**ValidationFrequency — Frequency of network validation**

positive integer

Frequency of network validation in number of iterations, specified as a positive integer.

The `ValidationFrequency` value is the number of iterations between evaluations of validation metrics.

**ValidationPatience — Patience of validation stopping**

positive integer | Inf

Patience of validation stopping of network training, specified as a positive integer or Inf.

The 'ValidationPatience' value is the number of times that the loss on the validation set can be larger than or equal to the previously smallest loss before network training stops.

**Solver Options****InitialLearnRate — Initial learning rate**

positive scalar

Initial learning rate used for training, specified as a positive scalar. If the learning rate is too low, then training takes a long time. If the learning rate is too high, then training can reach a suboptimal result.

**LearnRateScheduleSettings — Settings for learning rate schedule**

structure

Settings for the learning rate schedule, specified as a structure. `LearnRateScheduleSettings` has the field `Method`, which specifies the type of method for adjusting the learning rate. The possible methods are:

- 'none' — The learning rate is constant throughout training.
- 'piecewise' — The learning rate drops periodically during training.

If `Method` is 'piecewise', then `LearnRateScheduleSettings` contains two more fields:

- `DropRateFactor` — The multiplicative factor by which the learning rate drops during training
- `DropPeriod` — The number of epochs that passes between adjustments to the learning rate during training

Specify the settings for the learning schedule rate using `trainingOptions`.

Data Types: `struct`

**L2Regularization — Factor for L<sub>2</sub> regularizer**

nonnegative scalar

Factor for L<sub>2</sub> regularizer (weight decay), specified as a nonnegative scalar.

You can specify a multiplier for the L<sub>2</sub> regularizer for network layers with learnable parameters.

**Momentum — Contribution of previous gradient step**

scalar from 0 to 1

Contribution of the gradient step from the previous iteration to the current iteration of the training, specified as a scalar value from 0 to 1. A value of 0 means no contribution from the previous step, whereas a value of 1 means maximal contribution from the previous step. For more information about the different solvers, see “Stochastic Gradient Descent” on page 1-800.

**Gradient Clipping****GradientThreshold — Gradient threshold**

positive scalar | Inf

Positive threshold for the gradient, specified as positive scalar or Inf. When the gradient exceeds the value of GradientThreshold, then the gradient is clipped according to GradientThresholdMethod.

**GradientThresholdMethod — Gradient threshold method**

'l2norm' | 'global-l2norm' | 'absolutevalue'

Gradient threshold method used to clip gradient values that exceed the gradient threshold, specified as one of the following:

- 'l2norm' — If the  $L_2$  norm of the gradient of a learnable parameter is larger than GradientThreshold, then scale the gradient so that the  $L_2$  norm equals GradientThreshold.
- 'global-l2norm' — If the global  $L_2$  norm,  $L$ , is larger than GradientThreshold, then scale all gradients by a factor of GradientThreshold/ $L$ . The global  $L_2$  norm considers all learnable parameters.
- 'absolute-value' — If the absolute value of an individual partial derivative in the gradient of a learnable parameter is larger than GradientThreshold, then scale the partial derivative to have magnitude equal to GradientThreshold and retain the sign of the partial derivative.

For more information, see Gradient Clipping on page 1-802.

**ResetInputNormalization — Option to reset input layer normalization**

true (default) | false

Option to reset input layer normalization, specified as one of the following:

- true - Reset the input layer normalization statistics and recalculate them at training time.
- false - Calculate normalization statistics at training time when they are empty.

**Sequence Options****SequenceLength — Option to pad or truncate sequences**

'longest' | 'shortest' | positive integer

Option to pad, truncate, or split input sequences, specified as one of the following:

- 'longest' — Pad sequences in each mini-batch to have the same length as the longest sequence. This option does not discard any data, though padding can introduce noise to the network.
- 'shortest' — Truncate sequences in each mini-batch to have the same length as the shortest sequence. This option ensures that no padding is added, at the cost of discarding data.

- Positive integer — For each mini-batch, pad the sequences to the nearest multiple of the specified length that is greater than the longest sequence length in the mini-batch, and then split the sequences into smaller sequences of the specified length. If splitting occurs, then the software creates extra mini-batches. Use this option if the full sequences do not fit in memory. Alternatively, try reducing the number of sequences per mini-batch by setting the 'MiniBatchSize' option to a lower value.

To learn more about the effect of padding, truncating, and splitting the input sequences, see “Sequence Padding, Truncation, and Splitting”.

### **SequencePaddingDirection — Direction of padding or truncation**

'right' (default) | 'left'

Direction of padding or truncation, specified as one of the following:

- 'right' — Pad or truncate sequences on the right. The sequences start at the same time step and the software truncates or adds padding to the end of the sequences.
- 'left' — Pad or truncate sequences on the left. The software truncates or adds padding to the start of the sequences so that the sequences end at the same time step.

Because LSTM layers process sequence data one time step at a time, when the layer `OutputMode` property is 'last', any padding in the final time steps can negatively influence the layer output. To pad or truncate sequence data on the left, set the 'SequencePaddingDirection' option to 'left'.

For sequence-to-sequence networks (when the `OutputMode` property is 'sequence' for each LSTM layer), any padding in the first time steps can negatively influence the predictions for the earlier time steps. To pad or truncate sequence data on the right, set the 'SequencePaddingDirection' option to 'right'.

To learn more about the effect of padding, truncating, and splitting the input sequences, see “Sequence Padding, Truncation, and Splitting”.

### **SequencePaddingValue — Value to pad sequences**

scalar

Value by which to pad input sequences, specified as a scalar. The option is valid only when `SequenceLength` is 'longest' or a positive integer. Do not pad sequences with NaN, because doing so can propagate errors throughout the network.

## **Hardware Options**

### **ExecutionEnvironment — Hardware resource for training network**

'auto' | 'cpu' | 'gpu' | 'multi-gpu' | 'parallel'

Hardware resource for training network, specified as one of the following:

- 'auto' — Use a GPU if one is available. Otherwise, use the CPU.
- 'cpu' — Use the CPU.
- 'gpu' — Use the GPU.
- 'multi-gpu' — Use multiple GPUs on one machine, using a local parallel pool based on your default cluster profile. If there is no current parallel pool, the software starts a parallel pool with pool size equal to the number of available GPUs.

- `'parallel'` — Use a local or remote parallel pool based on your default cluster profile. If there is no current parallel pool, the software starts one using the default cluster profile. If the pool has access to GPUs, then only workers with a unique GPU perform training computation. If the pool does not have GPUs, then training takes place on all available CPU workers instead.

For more information on when to use the different execution environments, see “Scale Up Deep Learning in Parallel and in the Cloud”.

GPU, multi-GPU, and parallel options require Parallel Computing Toolbox. To use a GPU for deep learning, you must also have a CUDA enabled NVIDIA GPU with compute capability 3.0 or higher. If you choose one of these options and Parallel Computing Toolbox or a suitable GPU is not available, then the software returns an error.

To see an improvement in performance when training in parallel, try scaling up the `MiniBatchSize` and `InitialLearnRate` training options by the number of GPUs.

Training long short-term memory networks supports single CPU or single GPU training only.

Specify the execution environment using `trainingOptions`.

Data Types: `char` | `string`

#### **WorkerLoad — Parallel worker load division**

scalar from 0 to 1 | positive integer | numeric vector

Worker load division for GPUs or CPUs, specified as a scalar from 0 to 1, a positive integer, or a numeric vector. This property has an effect only when the `ExecutionEnvironment` value equals `'multi-gpu'` or `'parallel'`.

### **Checkpoints**

#### **CheckpointPath — Path for saving checkpoint networks**

character vector

Path where checkpoint networks are saved, specified as a character vector.

Data Types: `char`

#### **OutputFcn — Output functions**

function handle | cell array of function handles

Output functions to call during training, specified as a function handle or cell array of function handles. `trainNetwork` calls the specified functions once before the start of training, after each iteration, and once after training has finished. `trainNetwork` passes a structure containing information in the following fields:

Field	Description
Epoch	Current epoch number
Iteration	Current iteration number
TimeSinceStart	Time in seconds since the start of training
TrainingLoss	Current mini-batch loss
ValidationLoss	Loss on the validation data

Field	Description
BaseLearnRate	Current base learning rate
TrainingAccuracy	Accuracy on the current mini-batch (classification networks)
TrainingRMSE	RMSE on the current mini-batch (regression networks)
ValidationAccuracy	Accuracy on the validation data (classification networks)
ValidationRMSE	RMSE on the validation data (regression networks)
State	Current training state, with a possible value of "start", "iteration", or "done".

If a field is not calculated or relevant for a certain call to the output functions, then that field contains an empty array.

You can use output functions to display or plot progress information, or to stop training. To stop training early, make your output function return `true`. If any output function returns `true`, then training finishes and `trainNetwork` returns the latest network. For an example showing how to use output functions, see “Customize Output During Deep Learning Network Training” .

Data Types: `function_handle` | `cell`

## Examples

### Specify Training Options

Create a set of options for training a network using stochastic gradient descent with momentum. Reduce the learning rate by a factor of 0.2 every 5 epochs. Set the maximum number of epochs for training to 20, and use a mini-batch with 64 observations at each iteration. Turn on the training progress plot.

```
options = trainingOptions('sgdm', ...
    'LearnRateSchedule','piecewise', ...
    'LearnRateDropFactor',0.2, ...
    'LearnRateDropPeriod',5, ...
    'MaxEpochs',20, ...
    'MiniBatchSize',64, ...
    'Plots','training-progress')
```

```
options =
    TrainingOptionsSGDM with properties:

        Momentum: 0.9000
        InitialLearnRate: 0.0100
        LearnRateSchedule: 'piecewise'
        LearnRateDropFactor: 0.2000
        LearnRateDropPeriod: 5
        L2Regularization: 1.0000e-04
        GradientThresholdMethod: 'l2norm'
        GradientThreshold: Inf
```



```
    MaxEpochs: 20
    MiniBatchSize: 64
    Verbose: 1
    VerboseFrequency: 50
    ValidationData: []
    ValidationFrequency: 50
    ValidationPatience: Inf
    Shuffle: 'once'
    CheckpointPath: ''
    ExecutionEnvironment: 'auto'
    WorkerLoad: []
    OutputFcn: []
    Plots: 'training-progress'
    SequenceLength: 'longest'
    SequencePaddingValue: 0
    SequencePaddingDirection: 'right'
    DispatchInBackground: 0
    ResetInputNormalization: 1
```

## See Also

[trainNetwork](#) | [trainingOptions](#)

## Topics

“Create Simple Deep Learning Network for Classification”

“Transfer Learning Using AlexNet”

“Resume Training from Checkpoint Network”

“Deep Learning with Big Data on CPUs, GPUs, in Parallel, and on the Cloud”

“Specify Layers of Convolutional Neural Network”

“Set Up Parameters and Train Convolutional Neural Network”

**Introduced in R2016a**

## trainNetwork

Train neural network for deep learning

### Syntax

```
net = trainNetwork(imds, layers, options)
net = trainNetwork(ds, layers, options)

net = trainNetwork(X, Y, layers, options)
net = trainNetwork(sequences, Y, layers, options)

net = trainNetwork(tbl, layers, options)
net = trainNetwork(tbl, responseName, layers, options)

[net, info] = trainNetwork( ___ )
```

### Description

Use `trainNetwork` to train a convolutional neural network (ConvNet, CNN), a long short-term memory (LSTM) network, or a bidirectional LSTM (BiLSTM) network for deep learning classification and regression problems. You can train a network on either a CPU or a GPU. For image classification and image regression, you can train using multiple GPUs or in parallel. Using GPU, multi-GPU, and parallel options requires Parallel Computing Toolbox. To use a GPU for deep learning, you must also have a CUDA enabled NVIDIA GPU with compute capability 3.0 or higher. Specify training options, including options for the execution environment, by using `trainingOptions`.

`net = trainNetwork(imds, layers, options)` trains a network for image classification problems. The image datastore `imds` stores the input image data, `layers` defines the network architecture, and `options` defines the training options.

`net = trainNetwork(ds, layers, options)` trains a network using the datastore `ds`. For networks with multiple inputs, use this syntax with a combined or transformed datastore.

`net = trainNetwork(X, Y, layers, options)` trains a network for image classification and regression problems. The numeric array `X` contains the predictor variables and `Y` contains the categorical labels or numeric responses.

`net = trainNetwork(sequences, Y, layers, options)` trains a network for sequence classification and regression problems (for example, an LSTM or BiLSTM network), where `sequences` contains sequence or time series predictors and `Y` contains the responses. For classification problems, `Y` is a categorical vector or a cell array of categorical sequences. For regression problems, `Y` is a matrix of targets or a cell array of numeric sequences.

`net = trainNetwork(tbl, layers, options)` trains a network for classification and regression problems. The table `tbl` contains numeric data or file paths to the data. The predictors must be in the first column of `tbl`. For information on the targets or response variables, see “tbl” on page 1-0 .

`net = trainNetwork(tbl, responseName, layers, options)` trains a network for classification and regression problems. The predictors must be in the first column of `tbl`. The `responseName` argument specifies the response variables in `tbl`.

[net,info] = trainNetwork( \_\_\_ ) also returns information on the training using any of the input arguments in the previous syntaxes.

## Examples

### Train Network for Image Classification

Load the data as an ImageDatastore object.

```
digitDatasetPath = fullfile(matlabroot,'toolbox','nnet', ...  
    'nndemos','nndatasets','DigitDataset');  
imds = imageDatastore(digitDatasetPath, ...  
    'IncludeSubfolders',true, ...  
    'LabelSource','foldernames');
```

The datastore contains 10,000 synthetic images of digits from 0 to 9. The images are generated by applying random transformations to digit images created with different fonts. Each digit image is 28-by-28 pixels. The datastore contains an equal number of images per category.

Display some of the images in the datastore.

```
figure  
numImages = 10000;  
perm = randperm(numImages,20);  
for i = 1:20  
    subplot(4,5,i);  
    imshow(imds.Files{perm(i)});  
end
```

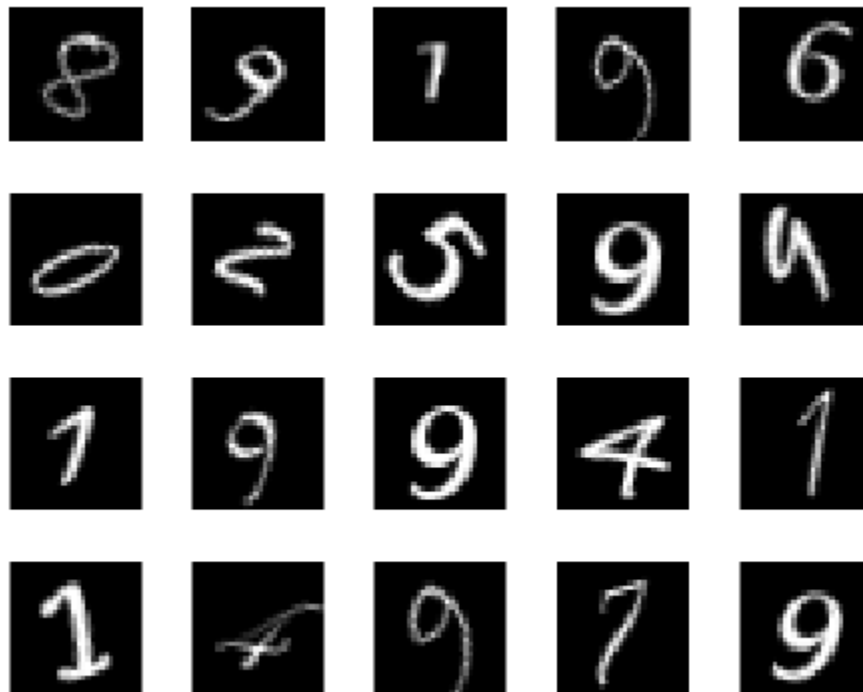

Divide the datastore so that each category in the training set has 750 images and the testing set has the remaining images from each label.

```
numTrainingFiles = 750;
[imdsTrain,imdsTest] = splitEachLabel(imds,numTrainingFiles,'randomize');
```

`splitEachLabel` splits the image files in `digitData` into two new datastores, `imdsTrain` and `imdsTest`.

Define the convolutional neural network architecture.

```
layers = [ ...
    imageInputLayer([28 28 1])
    convolution2dLayer(5,20)
    reluLayer
    maxPooling2dLayer(2,'Stride',2)
    fullyConnectedLayer(10)
    softmaxLayer
    classificationLayer];
```

Set the options to the default settings for the stochastic gradient descent with momentum. Set the maximum number of epochs at 20, and start the training with an initial learning rate of 0.0001.

```
options = trainingOptions('sgdm', ...
    'MaxEpochs',20,...
    'InitialLearnRate',1e-4, ...
    'Verbose',false, ...
    'Plots','training-progress');
```

Train the network.

```
net = trainNetwork(imdsTrain, layers, options);
```

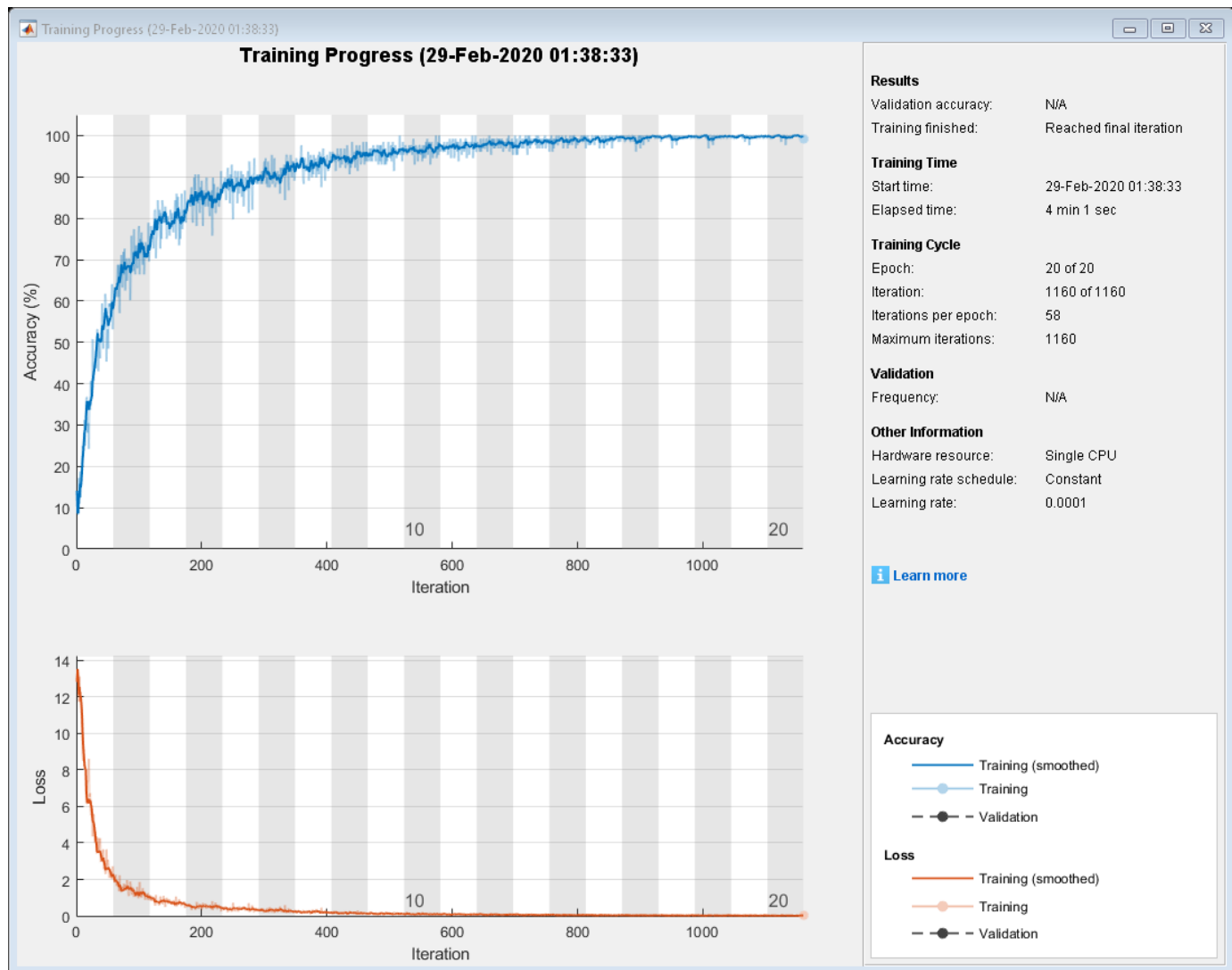

Run the trained network on the test set, which was not used to train the network, and predict the image labels (digits).

```
YPred = classify(net, imdsTest);
YTest = imdsTest.Labels;
```

Calculate the accuracy. The accuracy is the ratio of the number of true labels in the test data matching the classifications from `classify` to the number of images in the test data.

```
accuracy = sum(YPred == YTest)/numel(YTest)
```

```
accuracy = 0.9412
```

## Train Network with Augmented Images

Train a convolutional neural network using augmented image data. Data augmentation helps prevent the network from overfitting and memorizing the exact details of the training images.

Load the sample data, which consists of synthetic images of handwritten digits.

```
[XTrain,YTrain] = digitTrain4DArrayData;
```

`digitTrain4DArrayData` loads the digit training set as 4-D array data. `XTrain` is a 28-by-28-by-1-by-5000 array, where:

- 28 is the height and width of the images.
- 1 is the number of channels.
- 5000 is the number of synthetic images of handwritten digits.

`YTrain` is a categorical vector containing the labels for each observation.

Set aside 1000 of the images for network validation.

```
idx = randperm(size(XTrain,4),1000);  
XValidation = XTrain(:,:,,idx);  
XTrain(:,:,,idx) = [];  
YValidation = YTrain(idx);  
YTrain(idx) = [];
```

Create an `imageDataAugmenter` object that specifies preprocessing options for image augmentation, such as resizing, rotation, translation, and reflection. Randomly translate the images up to three pixels horizontally and vertically, and rotate the images with an angle up to 20 degrees.

```
imageAugmenter = imageDataAugmenter( ...  
    'RandRotation',[-20,20], ...  
    'RandXTranslation',[-3 3], ...  
    'RandYTranslation',[-3 3])
```

```
imageAugmenter =  
    imageDataAugmenter with properties:
```

```
    FillValue: 0  
    RandXReflection: 0  
    RandYReflection: 0  
    RandRotation: [-20 20]  
    RandScale: [1 1]  
    RandXScale: [1 1]  
    RandYScale: [1 1]  
    RandXShear: [0 0]  
    RandYShear: [0 0]  
    RandXTranslation: [-3 3]  
    RandYTranslation: [-3 3]
```

Create an `augmentedImageDatastore` object to use for network training and specify the image output size. During training, the datastore performs image augmentation and resizes the images. The datastore augments the images without saving any images to memory. `trainNetwork` updates the network parameters and then discards the augmented images.

```
imageSize = [28 28 1];  
augimds = augmentedImageDatastore(imageSize,XTrain,YTrain,'DataAugmentation',imageAugmenter);
```

Specify the convolutional neural network architecture.

```
layers = [  
    imageInputLayer(imageSize)  
  
    convolution2dLayer(3,8,'Padding','same')  
    batchNormalizationLayer  
    reluLayer  
  
    maxPooling2dLayer(2,'Stride',2)  
  
    convolution2dLayer(3,16,'Padding','same')  
    batchNormalizationLayer  
    reluLayer  
  
    maxPooling2dLayer(2,'Stride',2)  
  
    convolution2dLayer(3,32,'Padding','same')  
    batchNormalizationLayer  
    reluLayer  
  
    fullyConnectedLayer(10)  
    softmaxLayer  
    classificationLayer];
```

Specify training options for stochastic gradient descent with momentum.

```
opts = trainingOptions('sgdm', ...  
    'MaxEpochs',15, ...  
    'Shuffle','every-epoch', ...  
    'Plots','training-progress', ...  
    'Verbose',false, ...  
    'ValidationData',{XValidation,YValidation});
```

Train the network. Because the validation images are not augmented, the validation accuracy is higher than the training accuracy.

```
net = trainNetwork(augimds,layers,opts);
```

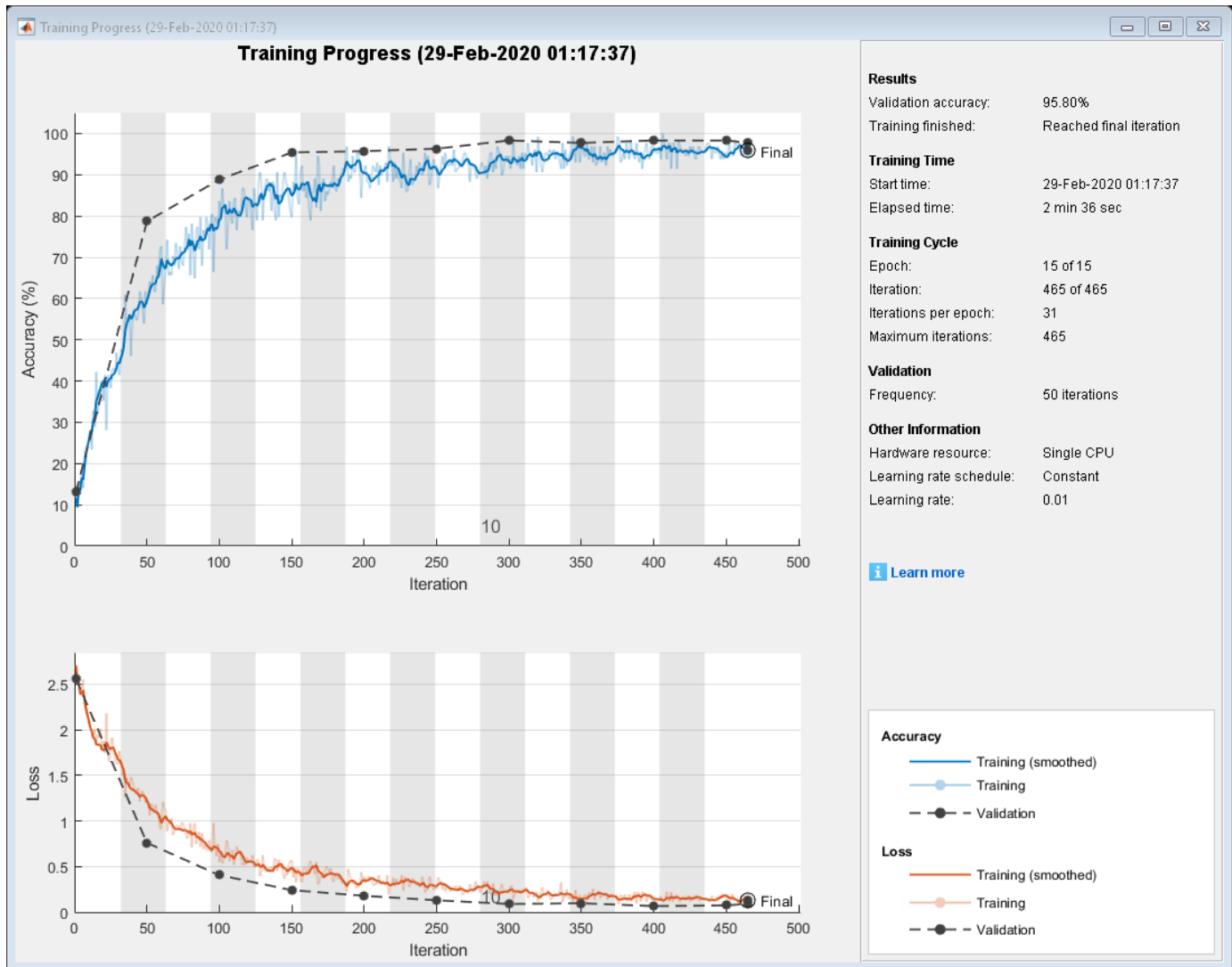

### Train Network for Image Regression

Load the sample data, which consists of synthetic images of handwritten digits. The third output contains the corresponding angles in degrees by which each image has been rotated.

Load the training images as 4-D arrays using `digitTrain4DArrayData`. The output `XTrain` is a 28-by-28-by-1-by-5000 array, where:

- 28 is the height and width of the images.
- 1 is the number of channels.
- 5000 is the number of synthetic images of handwritten digits.

`YTrain` contains the rotation angles in degrees.

```
[XTrain,~,YTrain] = digitTrain4DArrayData;
```



Display 20 random training images using imshow.

```
figure
numTrainImages = numel(YTrain);
idx = randperm(numTrainImages,20);
for i = 1:numel(idx)
    subplot(4,5,i)
    imshow(XTrain(:,:, :,idx(i)))
end
```

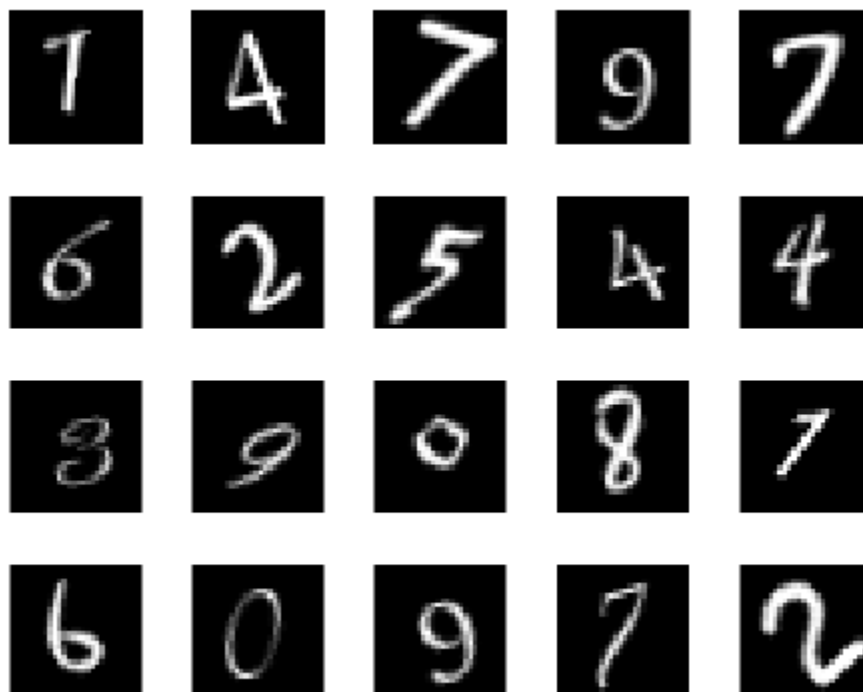

Specify the convolutional neural network architecture. For regression problems, include a regression layer at the end of the network.

```
layers = [ ...
    imageInputLayer([28 28 1])
    convolution2dLayer(12,25)
    reluLayer
    fullyConnectedLayer(1)
    regressionLayer];
```

Specify the network training options. Set the initial learn rate to 0.001.

```
options = trainingOptions('sgdm', ...
    'InitialLearnRate',0.001, ...
    'Verbose',false, ...
    'Plots','training-progress');
```

Train the network.

```
net = trainNetwork(XTrain,YTrain,layers,options);
```

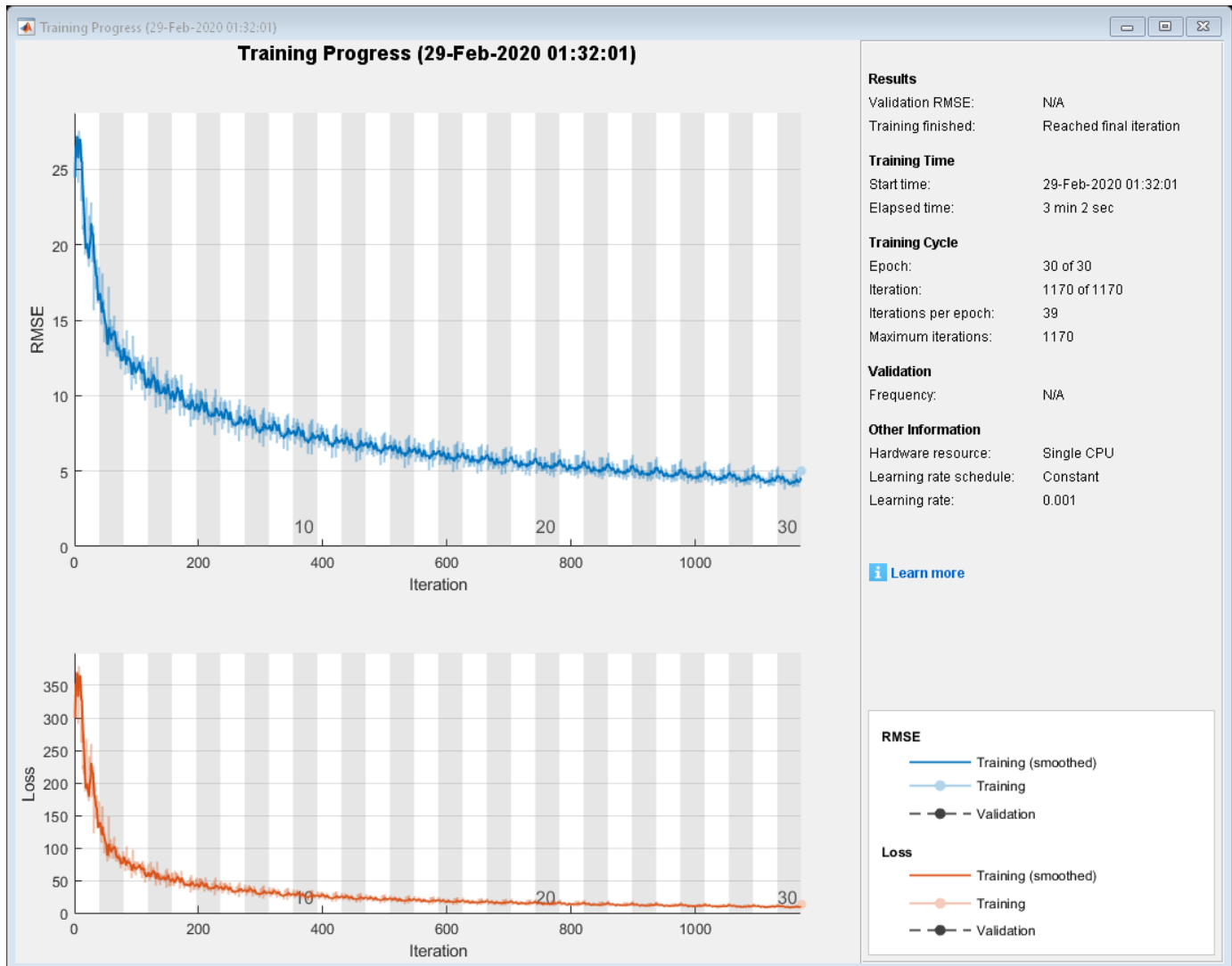

Test the performance of the network by evaluating the prediction accuracy of the test data. Use `predict` to predict the angles of rotation of the validation images.

```
[XTest,~ ,YTest] = digitTest4DArrayData;
YPred = predict(net,XTest);
```

Evaluate the performance of the model by calculating the root-mean-square error (RMSE) of the predicted and actual angles of rotation.

```
rmse = sqrt(mean((YTest - YPred).^2))
```

```
rmse = single
    6.0655
```

## Train Network for Sequence Classification

Train a deep learning LSTM network for sequence-to-label classification.

Load the Japanese Vowels data set as described in [1] and [2]. `XTrain` is a cell array containing 270 sequences of varying length with a feature dimension of 12. `Y` is a categorical vector of labels 1,2,...,9. The entries in `XTrain` are matrices with 12 rows (one row for each feature) and a varying number of columns (one column for each time step).

```
[XTrain,YTrain] = japaneseVowelsTrainData;
```

Visualize the first time series in a plot. Each line corresponds to a feature.

```
figure
plot(XTrain{1}')
title("Training Observation 1")
numFeatures = size(XTrain{1},1);
legend("Feature " + string(1:numFeatures), 'Location', 'northeastoutside')
```

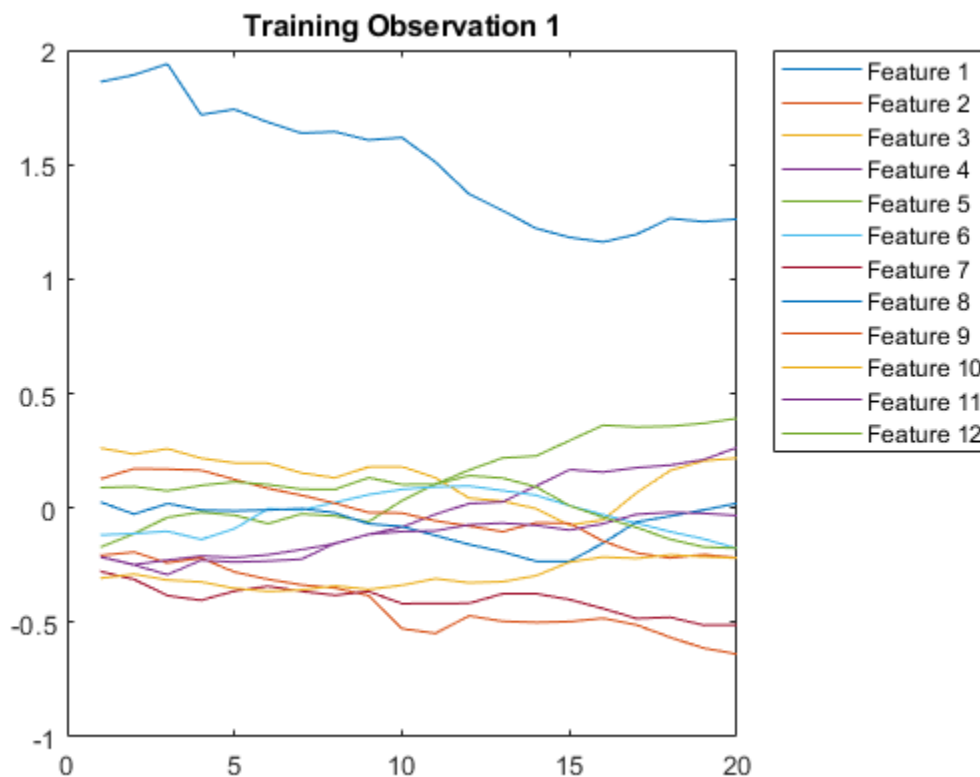

Define the LSTM network architecture. Specify the input size as 12 (the number of features of the input data). Specify an LSTM layer to have 100 hidden units and to output the last element of the sequence. Finally, specify nine classes by including a fully connected layer of size 9, followed by a softmax layer and a classification layer.

```
inputSize = 12;
numHiddenUnits = 100;
numClasses = 9;
```

```
layers = [ ...  
    sequenceInputLayer(inputSize)  
    lstmLayer(numHiddenUnits,'OutputMode','last')  
    fullyConnectedLayer(numClasses)  
    softmaxLayer  
    classificationLayer]
```

```
layers =  
    5x1 Layer array with layers:
```

1	''	Sequence Input	Sequence input with 12 dimensions
2	''	LSTM	LSTM with 100 hidden units
3	''	Fully Connected	9 fully connected layer
4	''	Softmax	softmax
5	''	Classification Output	crossentropyex

Specify the training options. Specify the solver as 'adam' and 'GradientThreshold' as 1. Set the mini-batch size to 27 and set the maximum number of epochs to 100.

Because the mini-batches are small with short sequences, the CPU is better suited for training. Set 'ExecutionEnvironment' to 'cpu'. To train on a GPU, if available, set 'ExecutionEnvironment' to 'auto' (the default value).

```
maxEpochs = 100;  
miniBatchSize = 27;  
  
options = trainingOptions('adam', ...  
    'ExecutionEnvironment','cpu', ...  
    'MaxEpochs',maxEpochs, ...  
    'MiniBatchSize',miniBatchSize, ...  
    'GradientThreshold',1, ...  
    'Verbose',false, ...  
    'Plots','training-progress');
```

Train the LSTM network with the specified training options.

```
net = trainNetwork(XTrain,YTrain,layers,options);
```

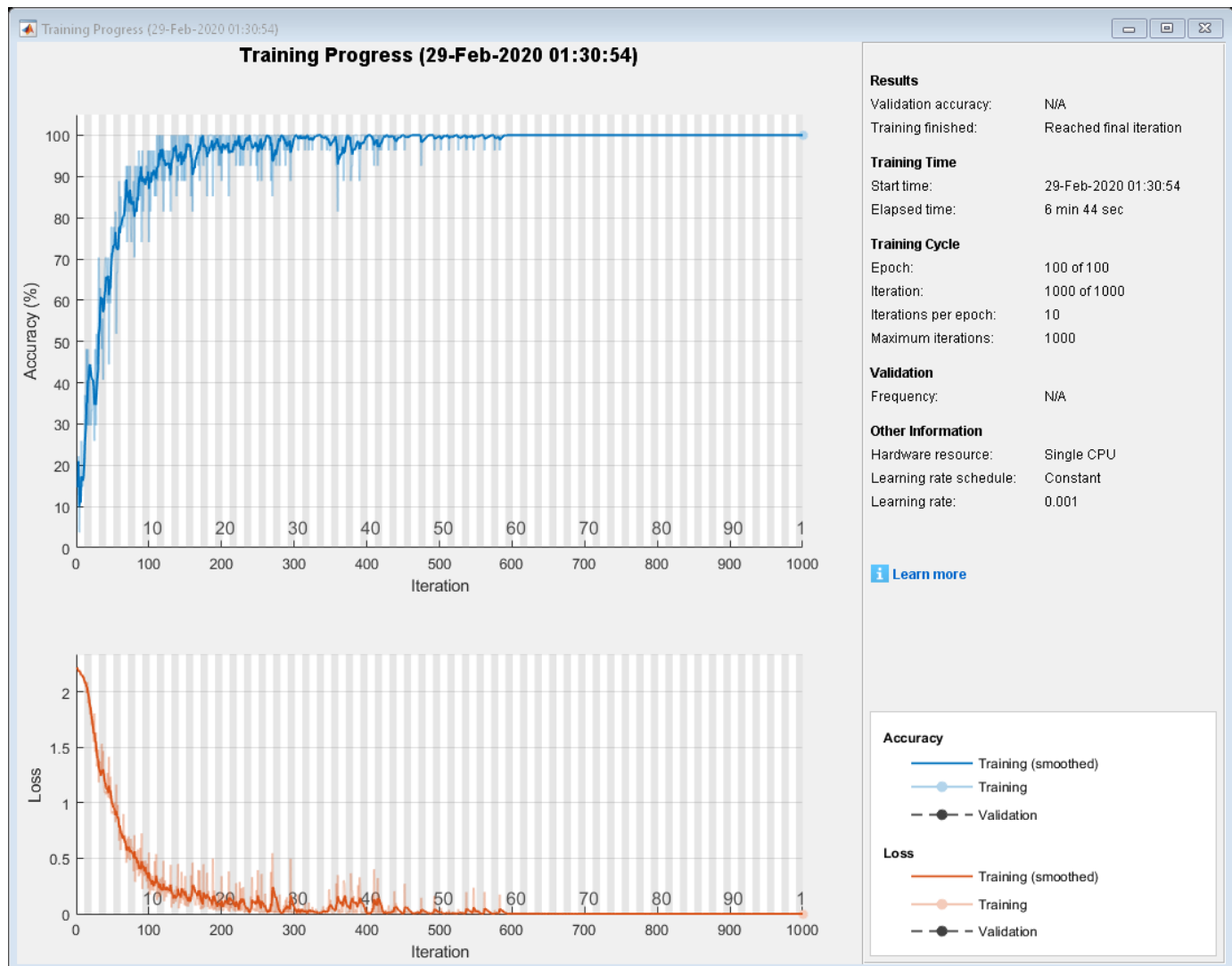

Load the test set and classify the sequences into speakers.

```
[XTest,YTest] = japaneseVowelsTestData;
```

Classify the test data. Specify the same mini-batch size used for training.

```
YPred = classify(net,XTest,'MiniBatchSize',miniBatchSize);
```

Calculate the classification accuracy of the predictions.

```
acc = sum(YPred == YTest)./numel(YTest)
```

```
acc = 0.9486
```

## Input Arguments

**imds** — Image datastore

ImageDatastore object

Image datastore, specified as an `ImageDatastore` object.

`ImageDatastore` allows batch reading of JPG or PNG image files using prefetching. If you use a custom function for reading the images, then `ImageDatastore` does not prefetch.

**Tip** Use `augmentedImageDatastore` for efficient preprocessing of images for deep learning including image resizing.

Do not use the `readFcn` option of `imageDatastore` as this option is usually significantly slower.

## ds – Datastore

`datastore`

Datastore for out-of-memory data and preprocessing.

For networks with a single input, the table or cell array returned by the datastore has two columns that specify the network inputs and expected responses, respectively.

For networks with multiple inputs, the datastore must be a combined or transformed datastore that returns a cell array with  $(\text{numInputs}+1)$  columns containing the predictors and the responses, where `numInputs` is the number of network inputs and `numResponses` is the number of responses. For `i` less than or equal to `numInputs`, the `i`th element of the cell array corresponds to the input layers `InputNames(i)`, where `layers` is the layer graph defining the network architecture. The last column of the cell array corresponds to the responses.

The table below lists the datastores that are directly compatible with `trainNetwork`. You can use other built-in datastores for training deep learning networks by using the `transform` and `combine` functions. These functions can convert the data read from datastores to the table or cell array format required by `trainNetwork`. For more information, see “Datastores for Deep Learning”.

Type of Datastore	Description
<code>CombinedDatastore</code>	Horizontally concatenate the data read from two or more underlying datastores.
<code>TransformedDatastore</code>	Transform batches of read data from an underlying datastore according to your own preprocessing pipeline.
<code>AugmentedImageDatastore</code>	Apply random affine geometric transformations, including resizing, rotation, reflection, shear, and translation, for training deep neural networks.
<code>PixelLabelImageDatastore</code>	Apply identical affine geometric transformations to images and corresponding ground truth labels for training semantic segmentation networks (requires Computer Vision Toolbox).
<code>RandomPatchExtractionDatastore</code>	Extract pairs of random patches from images or pixel label images (requires Image Processing Toolbox™). You optionally can apply identical random affine geometric transformations to the pairs of patches.
<code>DenoisingImageDatastore</code>	Apply randomly generated Gaussian noise for training denoising networks (requires Image Processing Toolbox).
Custom mini-batch datastore	Create mini-batches of sequence, time series, or text data. For details, see “Develop Custom Mini-Batch Datastore”.

**X – Image data**

numeric array

Image data, specified as a numeric array. The size of the array depends on the type of image input:

Input	Description
2-D images	A $h$ -by- $w$ -by- $c$ -by- $N$ numeric array, where $h$ , $w$ , and $c$ are the height, width, and number of channels of the images, respectively, and $N$ is the number of images.
3-D images	A $h$ -by- $w$ -by- $d$ -by- $c$ -by- $N$ numeric array, where $h$ , $w$ , $d$ , and $c$ are the height, width, depth, and number of channels of the images, respectively, and $N$ is the number of images.

If the array contains NaNs, then they are propagated through the network.

**sequences – Sequence or time series data**

cell array of numeric arrays | numeric array | datastore

Sequence or time series data, specified as an  $N$ -by-1 cell array of numeric arrays, where  $N$  is the number of observations, a numeric array representing a single sequence, or a datastore.

For cell array or numeric array input, the dimensions of the numeric arrays containing the sequences depend on the type of data.

Input	Description
Vector sequences	$c$ -by- $s$ matrices, where $c$ is the number of features of the sequences and $s$ is the sequence length.
2-D image sequences	$h$ -by- $w$ -by- $c$ -by- $s$ arrays, where $h$ , $w$ , and $c$ correspond to the height, width, and number of channels of the images, respectively, and $s$ is the sequence length.
3-D image sequences	$h$ -by- $w$ -by- $d$ -by- $c$ -by- $s$ , where $h$ , $w$ , $d$ , and $c$ correspond to the height, width, depth, and number of channels of the 3-D images, respectively, and $s$ is the sequence length.

For datastore input, the datastore must return data as a cell array of sequences or a table whose first column contains sequences. The dimensions of the sequence data must correspond to the table above.

**Y – Responses**

categorical vector of labels | numeric array | cell array of categorical sequences | cell array of numeric sequences

Responses, specified as a categorical vector of labels, a numeric array, a cell array of categorical sequences, or cell array of numeric sequences. The format of  $Y$  depends on the type of task. Responses must not contain NaNs.

**Classification**

Task	Format
Image classification	$N$ -by-1 categorical vector of labels, where $N$ is the number of observations.
Sequence-to-label classification	
Sequence-to-sequence classification	$N$ -by-1 cell array of categorical sequences of labels, where $N$ is the number of observations. Each sequence has the same number of time steps as the corresponding input sequence after applying the <code>SequenceLength</code> option to each mini-batch independently.

For sequence-to-sequence classification problems with one observation, `sequences` can also be a vector. In this case, `Y` must be a categorical sequence of labels.

**Regression**

Task	Format
2-D image regression	<ul style="list-style-type: none"> <li><math>N</math>-by-<math>R</math> matrix, where <math>N</math> is the number of images and <math>R</math> is the number of responses.</li> <li><math>h</math>-by-<math>w</math>-by-<math>c</math>-by-<math>N</math> numeric array, where <math>h</math>, <math>w</math>, and <math>c</math> are the height, width, and number of channels of the images, respectively, and <math>N</math> is the number of images.</li> </ul>
3-D image regression	<ul style="list-style-type: none"> <li><math>N</math>-by-<math>R</math> matrix, where <math>N</math> is the number of images and <math>R</math> is the number of responses.</li> <li><math>h</math>-by-<math>w</math>-by-<math>d</math>-by-<math>c</math>-by-<math>N</math> numeric array, where <math>h</math>, <math>w</math>, <math>d</math>, and <math>c</math> are the height, width, depth, and number of channels of the images, respectively, and <math>N</math> is the number of images.</li> </ul>
Sequence-to-one regression	$N$ -by- $R$ matrix, where $N$ is the number of sequences and $R$ is the number of responses.
Sequence-to-sequence regression	$N$ -by-1 cell array of numeric sequences, where $N$ is the number of sequences. The sequences are matrices with $R$ rows, where $R$ is the number of responses. Each sequence has the same number of time steps as the corresponding input sequence after applying the <code>SequenceLength</code> option to each mini-batch independently.

For sequence-to-sequence regression problems with one observation, `sequences` can be a matrix. In this case, `Y` must be a matrix of responses.

Normalizing the responses often helps to stabilize and speed up training of neural networks for regression. For more information, see “Train Convolutional Neural Network for Regression”.

**tbl — Input data**  
table

Input data, specified as a table containing predictors in the first column and responses in the remaining column or columns. Each row in the table corresponds to an observation.



The arrangement of predictors and responses in the table columns depends on the type of problem.

### Classification

Task	Predictors	Responses
Image classification	<ul style="list-style-type: none"> <li>Absolute or relative file path to an image, specified as a character vector</li> <li>Image specified as a 3-D numeric array</li> </ul>	Categorical label
Sequence-to-label classification	Absolute or relative file path to a MAT file containing sequence or time series data.  The MAT file must contain a time series represented by a matrix with rows corresponding to data points and columns corresponding to time steps.	Categorical label
Sequence-to-sequence classification		Absolute or relative file path to a MAT file. The MAT file must contain a time series represented by a categorical vector, with entries corresponding to labels for each time step.

For classification problems, if you do not specify `responseName`, then the function, by default, uses the responses in the second column of `tbl`.

### Regression

Task	Predictors	Responses
Image regression	<ul style="list-style-type: none"> <li>Absolute or relative file path to an image, specified as a character vector</li> <li>Image specified as a 3-D numeric array</li> </ul>	<ul style="list-style-type: none"> <li>One or more columns of scalar values</li> <li>Numeric vector</li> <li>1-by-1 cell array containing a 3-D numeric array</li> </ul>
Sequence-to-one regression	Absolute or relative file path to a MAT file containing sequence or time series data.  The MAT file must contain a time series represented by a matrix with rows corresponding to data points and columns corresponding to time steps.	<ul style="list-style-type: none"> <li>One or more columns of scalar values</li> <li>Numeric vector</li> </ul>
Sequence-to-sequence regression		Absolute or relative file path to a MAT file. The MAT file must contain a time series represented by a matrix, where rows correspond to responses and columns correspond to time steps.

For regression problems, if you do not specify `responseName`, then the function, by default, uses the remaining columns of `tbl`. Normalizing the responses often helps to stabilize and speed up training of neural networks for regression. For more information, see “Train Convolutional Neural Network for Regression”.

Responses cannot contain NaNs. If the predictor data contains NaNs, then they are propagated through the training. However, in most cases, the training fails to converge.

Data Types: `table`

**responseName — Names of response variables in the input table**

character vector | cell array of character vectors | string array

Names of the response variables in the input table, specified as a character vector, cell array of character vectors, or a string array. For problems with one response, `responseName` is the corresponding variable name in `tbl`. For regression problems with multiple response variables, `responseName` is an array of the corresponding variable names in `tbl`.

Data Types: `char` | `cell` | `string`**layers — Network layers**

Layer array | LayerGraph object

Network layers, specified as a Layer array or a LayerGraph object.

To create a network with all layers connected sequentially, you can use a Layer array as the input argument. In this case, the returned network is a SeriesNetwork object.

A directed acyclic graph (DAG) network has a complex structure in which layers can have multiple inputs and outputs. To create a DAG network, specify the network architecture as a LayerGraph object and then use that layer graph as the input argument to `trainNetwork`.

For a list of built-in layers, see “List of Deep Learning Layers”.

**options — Training options**

TrainingOptionsSGDM | TrainingOptionsRMSProp | TrainingOptionsADAM

Training options, specified as a TrainingOptionsSGDM, TrainingOptionsRMSProp, or TrainingOptionsADAM object returned by the `trainingOptions` function. To specify solver and other options for network training, use `trainingOptions`.

**Output Arguments****net — Trained network**

SeriesNetwork object | DAGNetwork object

Trained network, returned as a SeriesNetwork object or a DAGNetwork object.

If you train the network using a Layer array as the `layers` input argument, then `net` is a SeriesNetwork object. If you train the network using a LayerGraph object as the input argument, then `net` is a DAGNetwork object.

**info — Training information**

structure

Training information, returned as a structure, where each field is a scalar or a numeric vector with one element per training iteration.

For classification problems, `info` contains the following fields:

- `TrainingLoss` — Loss function values
- `TrainingAccuracy` — Training accuracies
- `ValidationLoss` — Loss function values

- `ValidationAccuracy` — Validation accuracies
- `BaseLearnRate` — Learning rates
- `FinalValidationLoss` — Final validation loss
- `FinalValidationAccuracy` — Final validation accuracy

For regression problems, `info` contains the following fields:

- `TrainingLoss` — Loss function values
- `TrainingRMSE` — Training RMSE values
- `ValidationLoss` — Loss function values
- `ValidationRMSE` — Validation RMSE values
- `BaseLearnRate` — Learning rates
- `FinalValidationLoss` — Final validation loss
- `FinalValidationRMSE` — Final validation RMSE

The structure only contains the fields `ValidationLoss`, `ValidationAccuracy`, `ValidationRMSE`, `FinalValidationLoss`, `FinalValidationAccuracy` and `FinalValidationRMSE` when `options` specifies validation data. The `'ValidationFrequency'` option of `trainingOptions` determines which iterations the software calculates validation metrics. For iterations when the software does not calculate validation metrics, the corresponding values in the structure are NaN.

If your network contains batch normalization layers, then the final validation metrics are often different from the validation metrics evaluated during training. This is because batch normalization layers in the final network perform different operations than during training.

## More About

### Save Checkpoint Networks and Resume Training

Deep Learning Toolbox enables you to save networks as `.mat` files after each epoch during training. This periodic saving is especially useful when you have a large network or a large data set, and training takes a long time. If the training is interrupted for some reason, you can resume training from the last saved checkpoint network. If you want `trainNetwork` to save checkpoint networks, then you must specify the name of the path by using the `'CheckpointPath'` name-value pair argument of `trainingOptions`. If the path that you specify does not exist, then `trainingOptions` returns an error.

`trainNetwork` automatically assigns unique names to checkpoint network files. In the example name, `net_checkpoint__351__2018_04_12__18_09_52.mat`, 351 is the iteration number, 2018\_04\_12 is the date, and 18\_09\_52 is the time at which `trainNetwork` saves the network. You can load a checkpoint network file by double-clicking it or using the load command at the command line. For example:

```
load net_checkpoint__351__2018_04_12__18_09_52.mat
```

You can then resume training by using the layers of the network as an input argument to `trainNetwork`. For example:

```
trainNetwork(XTrain,YTrain,net.Layers,options)
```

You must manually specify the training options and the input data, because the checkpoint network does not contain this information. For an example, see “Resume Training from Checkpoint Network”.

## Floating-Point Arithmetic

All functions for deep learning training, prediction, and validation in Deep Learning Toolbox perform computations using single-precision, floating-point arithmetic. Functions for deep learning include `trainNetwork`, `predict`, `classify`, and `activations`. The software uses single-precision arithmetic when you train networks using both CPUs and GPUs.

## References

- [1] Kudo, M., J. Toyama, and M. Shimbo. "Multidimensional Curve Classification Using Passing-Through Regions." *Pattern Recognition Letters*. Vol. 20, No. 11-13, pp. 1103-1111.
- [2] Kudo, M., J. Toyama, and M. Shimbo. *Japanese Vowels Data Set*. <https://archive.ics.uci.edu/ml/datasets/Japanese+Vowels>

## Extended Capabilities

### Automatic Parallel Support

Accelerate code by automatically running computation in parallel using Parallel Computing Toolbox™.

To run computation in parallel, set the 'ExecutionEnvironment' option to 'multi-gpu' or 'parallel'.

Use `trainingOptions` to set the 'ExecutionEnvironment' and supply the options to `trainNetwork`. If you do not set 'ExecutionEnvironment', then `trainNetwork` runs on a GPU if available.

For details, see “Scale Up Deep Learning in Parallel and in the Cloud”.

## See Also

`DAGNetwork` | **Deep Network Designer** | `LayerGraph` | `SeriesNetwork` | `analyzeNetwork` | `assembleNetwork` | `classify` | `predict` | `trainingOptions`

## Topics

- “Create Simple Deep Learning Network for Classification”
- “Transfer Learning Using AlexNet”
- “Train Convolutional Neural Network for Regression”
- “Sequence Classification Using Deep Learning”
- “Deep Learning in MATLAB”
- “Define Custom Deep Learning Layers”
- “List of Deep Learning Layers”

## Introduced in R2016a

# transposedConv2dLayer

Transposed 2-D convolution layer

## Syntax

```
layer = transposedConv2dLayer(filterSize,numFilters)
layer = transposedConv2dLayer(filterSize,numFilters,Name,Value)
```

## Description

A transposed 2-D convolution layer upsamples feature maps.

This layer is sometimes incorrectly known as a "deconvolution" or "deconv" layer. This layer is the transpose of convolution and does not perform deconvolution.

`layer = transposedConv2dLayer(filterSize,numFilters)` returns a transposed 2-D convolution layer and sets the `filterSize` and `numFilters` properties.

`layer = transposedConv2dLayer(filterSize,numFilters,Name,Value)` returns a transposed 2-D convolutional layer and specifies additional options using one or more name-value pair arguments.

## Examples

### Create Transposed Convolutional Layer

Create a transposed convolutional layer with 96 filters, each with a height and width of 11. Use a stride of 4 in the horizontal and vertical directions.

```
layer = transposedConv2dLayer(11,96,'Stride',4);
```

## Input Arguments

### **filterSize** — Height and width of filters

vector of two positive integers

Height and width of the filters, specified as a vector of two positive integers  $[h \ w]$ , where  $h$  is the height and  $w$  is the width. `FilterSize` defines the size of the local regions to which the neurons connect in the input.

If you set `FilterSize` using an input argument, then you can specify `FilterSize` as scalar to use the same value for both dimensions.

Example: `[5 5]` specifies filters of height 5 and width 5.

### **numFilters** — Number of filters

positive integer

Number of filters, specified as a positive integer. This number corresponds to the number of neurons in the layer that connect to the same region in the input. This parameter determines the number of channels (feature maps) in the output of the convolutional layer.

Example: 96

### **Name-Value Pair Arguments**

Specify optional comma-separated pairs of `Name`, `Value` arguments. `Name` is the argument name and `Value` is the corresponding value. `Name` must appear inside quotes. You can specify several name and value pair arguments in any order as `Name1, Value1, . . . , NameN, ValueN`.

Example: 'Cropping', 1

### **Transposed Convolution**

#### **Stride — Up-sampling factor**

1 (default) | vector of two positive integers | positive integer

Up-sampling factor of the input, specified as one of the following:

- A vector of two positive integers [a b], where a is the vertical stride and b is the horizontal stride.
- A positive integer the corresponds to both the vertical and horizontal stride.

Example: 'Stride', [2 1]

#### **Cropping — Output size reduction**

0 (default) | 'same' | nonnegative integer | vector of two nonnegative integers

Output size reduction, specified as one of the following:

- 'same' - Set the cropping so that the output size equals `inputSize .* Stride`, where `inputSize` is the height and width of the layer input. If you set the 'Cropping' option to 'same', then the software automatically sets the `CroppingMode` property of the layer to 'same'.

The software trims an equal amount from the top and bottom, and the left and right, if possible. If the vertical crop amount has an odd value, then the software trims an extra row from the bottom. If the horizontal crop amount has an odd value, then the software trims an extra column from the right.

- A positive integer - Crop the specified amount of data from all the edges.
- A vector of nonnegative integers [a b] - Crop a from the top and bottom and crop b from the left and right.
- A vector [t b l r] - Crop t, b, l, r from the top, bottom, left, and right of the input, respectively.

If you set the 'Cropping' option to a numeric value, then the software automatically sets the `CroppingMode` property of the layer to 'manual'.

Example: [1 2]

#### **NumChannels — Number of channels for each filter**

'auto' (default) | positive integer

Number of channels for each filter, specified as 'NumChannels' and 'auto' or a positive integer.

This parameter must be equal to the number of channels of the input to this convolutional layer. For example, if the input is a color image, then the number of channels for the input must be 3. If the number of filters for the convolutional layer prior to the current layer is 16, then the number of channels for this layer must be 16.

### Parameters and Initialization

#### WeightsInitializer — Function to initialize weights

'glorot' (default) | 'he' | 'narrow-normal' | 'zeros' | 'ones' | function handle

Function to initialize the weights, specified as one of the following:

- 'glorot' - Initialize the weights with the Glorot initializer [1] (also known as Xavier initializer). The Glorot initializer independently samples from a uniform distribution with zero mean and variance  $2/(\text{numIn} + \text{numOut})$ , where  $\text{numIn} = \text{filterSize}(1) * \text{filterSize}(2) * \text{NumChannels}$ ,  $\text{numOut} = \text{filterSize}(1) * \text{filterSize}(2) * \text{numFilters}$ , and  $\text{NumChannels}$  is the number of input channels.
- 'he' - Initialize the weights with the He initializer [2]. The He initializer samples from a normal distribution with zero mean and variance  $2/\text{numIn}$ , where  $\text{numIn} = \text{filterSize}(1) * \text{filterSize}(2) * \text{NumChannels}$  and  $\text{NumChannels}$  is the number of input channels.
- 'narrow-normal' - Initialize the weights by independently sampling from a normal distribution with zero mean and standard deviation 0.01.
- 'zeros' - Initialize the weights with zeros.
- 'ones' - Initialize the weights with ones.
- Function handle - Initialize the weights with a custom function. If you specify a function handle, then the function must be of the form  $\text{weights} = \text{func}(\text{sz})$ , where  $\text{sz}$  is the size of the weights. For an example, see “Specify Custom Weight Initialization Function”.

The layer only initializes the weights when the **Weights** property is empty.

Data Types: char | string | function\_handle

#### BiasInitializer — Function to initialize bias

'zeros' (default) | 'narrow-normal' | 'ones' | function handle

Function to initialize the bias, specified as one of the following:

- 'zeros' - Initialize the bias with zeros.
- 'ones' - Initialize the bias with ones.
- 'narrow-normal' - Initialize the bias by independently sampling from a normal distribution with zero mean and standard deviation 0.01.
- Function handle - Initialize the bias with a custom function. If you specify a function handle, then the function must be of the form  $\text{bias} = \text{func}(\text{sz})$ , where  $\text{sz}$  is the size of the bias.

The layer only initializes the bias when the **Bias** property is empty.

Data Types: char | string | function\_handle

#### Weights — Layer weights

[] (default) | numeric array

Layer weights for the convolutional layer, specified as a numeric array.

The layer weights are learnable parameters. You can specify the initial value for the weights directly using the `Weights` property of the layer. When training a network, if the `Weights` property of the layer is nonempty, then `trainNetwork` uses the `Weights` property as the initial value. If the `Weights` property is empty, then `trainNetwork` uses the initializer specified by the `WeightsInitializer` property of the layer.

At training time, `Weights` is a `filterSize(1)-by-filterSize(2)-by-numFilters-by-NumChannels` array.

Data Types: `single` | `double`

### **Bias — Layer biases**

`[]` (default) | numeric array

Layer biases for the convolutional layer, specified as a numeric array.

The layer biases are learnable parameters. When training a network, if `Bias` is nonempty, then `trainNetwork` uses the `Bias` property as the initial value. If `Bias` is empty, then `trainNetwork` uses the initializer specified by `BiasInitializer`.

At training time, `Bias` is a `1-by-1-by-numFilters` array.

Data Types: `single` | `double`

### **Learn Rate and Regularization**

#### **WeightLearnRateFactor — Learning rate factor for weights**

`1` (default) | nonnegative scalar

Learning rate factor for the weights, specified as a nonnegative scalar.

The software multiplies this factor by the global learning rate to determine the learning rate for the weights in this layer. For example, if `WeightLearnRateFactor` is 2, then the learning rate for the weights in this layer is twice the current global learning rate. The software determines the global learning rate based on the settings specified with the `trainingOptions` function.

Example: 2

#### **BiasLearnRateFactor — Learning rate factor for biases**

`1` (default) | nonnegative scalar

Learning rate factor for the biases, specified as a nonnegative scalar.

The software multiplies this factor by the global learning rate to determine the learning rate for the biases in this layer. For example, if `BiasLearnRateFactor` is 2, then the learning rate for the biases in the layer is twice the current global learning rate. The software determines the global learning rate based on the settings specified with the `trainingOptions` function.

Example: 2

#### **WeightL2Factor — L2 regularization factor for weights**

`1` (default) | nonnegative scalar

L2 regularization factor for the weights, specified as a nonnegative scalar.



The software multiplies this factor by the global L2 regularization factor to determine the L2 regularization for the weights in this layer. For example, if `WeightL2Factor` is 2, then the L2 regularization for the weights in this layer is twice the global L2 regularization factor. You can specify the global L2 regularization factor using the `trainingOptions` function.

Example: 2

### **BiasL2Factor — L2 regularization factor for biases**

0 (default) | nonnegative scalar

L2 regularization factor for the biases, specified as a nonnegative scalar.

The software multiplies this factor by the global L2 regularization factor to determine the L2 regularization for the biases in this layer. For example, if `BiasL2Factor` is 2, then the L2 regularization for the biases in this layer is twice the global L2 regularization factor. You can specify the global L2 regularization factor using the `trainingOptions` function.

Example: 2

### **Layer**

#### **Name — Layer name**

' ' (default) | character vector | string scalar

Layer name, specified as a character vector or a string scalar. To include a layer in a layer graph, you must specify a nonempty unique layer name. If you train a series network with the layer and `Name` is set to ' ', then the software automatically assigns a name to the layer at training time.

Data Types: `char` | `string`

## **Output Arguments**

### **layer — Transposed 2-D convolution layer**

`TransposedConvolution2DLayer` object

Transposed 2-D convolution layer, returned as a `TransposedConvolution2DLayer` object.

## **Compatibility Considerations**

### **Default weights initialization is Glorot**

*Behavior changed in R2019a*

Starting in R2019a, the software, by default, initializes the layer weights of this layer using the Glorot initializer. This behavior helps stabilize training and usually reduces the training time of deep networks.

In previous releases, the software, by default, initializes the layer weights by sampling from a normal distribution with zero mean and variance 0.01. To reproduce this behavior, set the `'WeightsInitializer'` option of the layer to `'narrow-normal'`.

## **References**

- [1] Glorot, Xavier, and Yoshua Bengio. "Understanding the difficulty of training deep feedforward neural networks." In *Proceedings of the thirteenth international conference on artificial intelligence and statistics*, pp. 249-256. 2010.

[2] He, Kaiming, Xiangyu Zhang, Shaoqing Ren, and Jian Sun. "Delving deep into rectifiers: Surpassing human-level performance on imagenet classification." In *Proceedings of the IEEE international conference on computer vision*, pp. 1026-1034. 2015.

## **Extended Capabilities**

### **GPU Code Generation**

Generate CUDA® code for NVIDIA® GPUs using GPU Coder™.

### **See Also**

[SoftmaxLayer](#) | [TransposedConvolution2DLayer](#) | [averagePooling2dLayer](#) | [maxPooling2dLayer](#)

### **Topics**

["Create Simple Deep Learning Network for Classification"](#)

["Deep Learning in MATLAB"](#)

["Compare Layer Weight Initializers"](#)

["List of Deep Learning Layers"](#)

### **Introduced in R2017b**

# transposedConv3dLayer

Transposed 3-D convolution layer

## Syntax

```
layer = transposedConv3dLayer(filterSize,numFilters)
layer = transposedConv3dLayer(filterSize,numFilters,Name,Value)
```

## Description

A transposed 3-D convolution layer upsamples three-dimensional feature maps.

This layer is sometimes incorrectly known as a "deconvolution" or "deconv" layer. This layer is the transpose of convolution and does not perform deconvolution.

`layer = transposedConv3dLayer(filterSize,numFilters)` returns a transposed 3-D convolution layer and sets the `FilterSize` and `NumFilters` properties.

`layer = transposedConv3dLayer(filterSize,numFilters,Name,Value)` returns a transposed 3-D convolutional layer and specifies additional options using one or more name-value pair arguments.

## Examples

### Create Transposed 3-D Convolutional Layer

Create a transposed 3-D convolutional layer with 32 filters, each with a height, width, and depth of 11. Use a stride of 4 in the horizontal and vertical directions and 2 along the depth.

```
layer = transposedConv3dLayer(11,32,'Stride',[4 4 2])
```

```
layer =
  TransposedConvolution3DLayer with properties:
```

```
    Name: ''
```

```
Hyperparameters
```

```
  FilterSize: [11 11 11]
  NumChannels: 'auto'
  NumFilters: 32
  Stride: [4 4 2]
  CroppingMode: 'manual'
  CroppingSize: [2x3 double]
```

```
Learnable Parameters
```

```
  Weights: []
  Bias: []
```

```
Show all properties
```

## Input Arguments

### **filterSize** — Height, width, and depth of filters

vector of three positive integers

Height, width, and depth of the filters, specified as a vector [h w d] of three positive integers, where h is the height, w is the width, and d is the depth. `FilterSize` defines the size of the local regions to which the neurons connect in the input.

If you set `FilterSize` using an input argument, then you can specify `FilterSize` as scalar to use the same value for all three dimensions.

Example: [5 5 5] specifies filters with a height, width, and depth of 5.

### **numFilters** — Number of filters

positive integer

Number of filters, specified as a positive integer. This number corresponds to the number of neurons in the convolutional layer that connect to the same region in the input. This parameter determines the number of channels (feature maps) in the output of the convolutional layer.

Example: 96

## Name-Value Pair Arguments

Specify optional comma-separated pairs of `Name`, `Value` arguments. `Name` is the argument name and `Value` is the corresponding value. `Name` must appear inside quotes. You can specify several name and value pair arguments in any order as `Name1, Value1, ..., NameN, ValueN`.

Example: 'Cropping', 1

## Transposed Convolution

### **Stride** — Step size for traversing input

[1 1 1] (default) | vector of three positive integers

Step size for traversing the input in three dimensions, specified as a vector [a b c] of three positive integers, where a is the vertical step size, b is the horizontal step size, and c is the step size along the depth. When creating the layer, you can specify `Stride` as a scalar to use the same value for step sizes in all three directions.

Example: [2 3 1] specifies a vertical step size of 2, a horizontal step size of 3, and a step size along the depth of 1.

### **Cropping** — Output size reduction

0 (default) | 'same' | vector of nonnegative integers | matrix of nonnegative integers

Output size reduction, specified as one of the following:

- 'same' - Set the cropping so that the output size equals `inputSize .* Stride`, where `inputSize` is the height, width, and depth of the layer input. If you set the 'Cropping' option to 'same', then the software automatically sets the `CroppingMode` property of the layer to 'same'.

The software trims an equal amount from the top and bottom, the left and right, and the front and back, if possible. If the vertical crop amount has an odd value, then the software trims an extra row from the bottom. If the horizontal crop amount has an odd value, then the software trims an

extra column from the right. If the depth crop amount has an odd value, then the software trims an extra plane from the back.

- A positive integer - Crop the specified amount of data from all the edges.
- A vector of nonnegative integers [a b c] - Crop a from the top and bottom, crop b from the left and right, and crop c from the front and back.
- a matrix of nonnegative integers [t l f; b r bk] of nonnegative integers — Crop t, l, f, b, r, bk from the top, left, front, bottom, right, and back of the input, respectively.

Example: [1 2 2]

### **NumChannels — Number of channels for each filter**

'auto' (default) | positive integer

Number of channels for each filter, specified as 'NumChannels' and 'auto' or a positive integer.

This parameter must be equal to the number of channels of the input to this convolutional layer. For example, if the input is a color image, then the number of channels for the input must be 3. If the number of filters for the convolutional layer prior to the current layer is 16, then the number of channels for this layer must be 16.

### **Parameters and Initialization**

#### **WeightsInitializer — Function to initialize weights**

'glorot' (default) | 'he' | 'narrow-normal' | 'zeros' | 'ones' | function handle

Function to initialize the weights, specified as one of the following:

- 'glorot' - Initialize the weights with the Glorot initializer [1] (also known as Xavier initializer). The Glorot initializer independently samples from a uniform distribution with zero mean and variance  $2/(\text{numIn} + \text{numOut})$ , where  $\text{numIn} = \text{filterSize}(1) * \text{filterSize}(2) * \text{filterSize}(3) * \text{NumChannels}$ ,  $\text{numOut} = \text{filterSize}(1) * \text{filterSize}(2) * \text{filterSize}(3) * \text{numFilters}$ , and NumChannels is the number of input channels.
- 'he' - Initialize the weights with the He initializer [2]. The He initializer samples from a normal distribution with zero mean and variance  $2/\text{numIn}$ , where  $\text{numIn} = \text{filterSize}(1) * \text{filterSize}(2) * \text{filterSize}(3) * \text{NumChannels}$  and NumChannels is the number of input channels.
- 'narrow-normal' - Initialize the weights by independently sampling from a normal distribution with zero mean and standard deviation 0.01.
- 'zeros' - Initialize the weights with zeros.
- 'ones' - Initialize the weights with ones.
- Function handle - Initialize the weights with a custom function. If you specify a function handle, then the function must be of the form  $\text{weights} = \text{func}(\text{sz})$ , where sz is the size of the weights. For an example, see "Specify Custom Weight Initialization Function".

The layer only initializes the weights when the Weights property is empty.

Data Types: char | string | function\_handle

#### **BiasInitializer — Function to initialize bias**

'zeros' (default) | 'narrow-normal' | 'ones' | function handle

Function to initialize the bias, specified as one of the following:

- 'zeros' - Initialize the bias with zeros.
- 'ones' - Initialize the bias with ones.
- 'narrow-normal' - Initialize the bias by independently sampling from a normal distribution with zero mean and standard deviation 0.01.
- Function handle - Initialize the bias with a custom function. If you specify a function handle, then the function must be of the form `bias = func(sz)`, where `sz` is the size of the bias.

The layer only initializes the bias when the `Bias` property is empty.

Data Types: `char` | `string` | `function_handle`

### **Weights — Layer weights**

`[]` (default) | numeric array

Layer weights for the transposed convolutional layer, specified as a numeric array.

The layer weights are learnable parameters. You can specify the initial value for the weights directly using the `Weights` property of the layer. When training a network, if the `Weights` property of the layer is nonempty, then `trainNetwork` uses the `Weights` property as the initial value. If the `Weights` property is empty, then `trainNetwork` uses the initializer specified by the `WeightsInitializer` property of the layer.

At training time, `Weights` is a `FilterSize(1)-by-FilterSize(2)-by-FilterSize(3)-by-numFilters-by-NumChannels` array.

Data Types: `single` | `double`

### **Bias — Layer biases**

`[]` (default) | numeric array

Layer biases for the transposed convolutional layer, specified as a numeric array.

The layer biases are learnable parameters. When training a network, if `Bias` is nonempty, then `trainNetwork` uses the `Bias` property as the initial value. If `Bias` is empty, then `trainNetwork` uses the initializer specified by `BiasInitializer`.

At training time, `Bias` 1-by-1-by-1-by-`numFilters` array.

Data Types: `single` | `double`

### **Learn Rate and Regularization**

#### **WeightLearnRateFactor — Learning rate factor for weights**

1 (default) | nonnegative scalar

Learning rate factor for the weights, specified as a nonnegative scalar.

The software multiplies this factor by the global learning rate to determine the learning rate for the weights in this layer. For example, if `WeightLearnRateFactor` is 2, then the learning rate for the weights in this layer is twice the current global learning rate. The software determines the global learning rate based on the settings specified with the `trainingOptions` function.

Example: 2

#### **BiasLearnRateFactor — Learning rate factor for biases**

1 (default) | nonnegative scalar

Learning rate factor for the biases, specified as a nonnegative scalar.

The software multiplies this factor by the global learning rate to determine the learning rate for the biases in this layer. For example, if `BiasLearnRateFactor` is 2, then the learning rate for the biases in the layer is twice the current global learning rate. The software determines the global learning rate based on the settings specified with the `trainingOptions` function.

Example: 2

### **WeightL2Factor — L2 regularization factor for weights**

1 (default) | nonnegative scalar

L2 regularization factor for the weights, specified as a nonnegative scalar.

The software multiplies this factor by the global L2 regularization factor to determine the L2 regularization for the weights in this layer. For example, if `WeightL2Factor` is 2, then the L2 regularization for the weights in this layer is twice the global L2 regularization factor. You can specify the global L2 regularization factor using the `trainingOptions` function.

Example: 2

### **BiasL2Factor — L2 regularization factor for biases**

0 (default) | nonnegative scalar

L2 regularization factor for the biases, specified as a nonnegative scalar.

The software multiplies this factor by the global L2 regularization factor to determine the L2 regularization for the biases in this layer. For example, if `BiasL2Factor` is 2, then the L2 regularization for the biases in this layer is twice the global L2 regularization factor. You can specify the global L2 regularization factor using the `trainingOptions` function.

Example: 2

## **Layer**

### **Name — Layer name**

' ' (default) | character vector | string scalar

Layer name, specified as a character vector or a string scalar. To include a layer in a layer graph, you must specify a nonempty unique layer name. If you train a series network with the layer and `Name` is set to ' ', then the software automatically assigns a name to the layer at training time.

Data Types: char | string

## **Output Arguments**

### **layer — Transposed 3-D convolution layer**

`TransposedConvolution3DLayer` object

Transposed 3-D convolution layer, returned as a `TransposedConvolution3DLayer` object.

## **References**

- [1] Glorot, Xavier, and Yoshua Bengio. "Understanding the difficulty of training deep feedforward neural networks." In *Proceedings of the thirteenth international conference on artificial intelligence and statistics*, pp. 249-256. 2010.

[2] He, Kaiming, Xiangyu Zhang, Shaoqing Ren, and Jian Sun. "Delving deep into rectifiers: Surpassing human-level performance on imagenet classification." In *Proceedings of the IEEE international conference on computer vision*, pp. 1026-1034. 2015.

### **See Also**

[SoftmaxLayer](#) | [TransposedConvolution3dLayer](#) | [averagePooling3dLayer](#) | [maxPooling3dLayer](#) | [transposedConv2dLayer](#)

### **Topics**

["3-D Brain Tumor Segmentation Using Deep Learning"](#)

["Deep Learning in MATLAB"](#)

["Specify Layers of Convolutional Neural Network"](#)

["List of Deep Learning Layers"](#)

**Introduced in R2019a**



# TransposedConvolution2DLayer

Transposed 2-D convolution layer

## Description

A transposed 2-D convolution layer upsamples feature maps.

This layer is sometimes incorrectly known as a "deconvolution" or "deconv" layer. This layer is the transpose of convolution and does not perform deconvolution.

## Creation

Create a transposed convolution 2-D output layer using `transposedConv2dLayer`.

## Properties

### Transposed Convolution

#### FilterSize — Height and width of filters

vector of two positive integers

Height and width of the filters, specified as a vector of two positive integers  $[h \ w]$ , where  $h$  is the height and  $w$  is the width. `FilterSize` defines the size of the local regions to which the neurons connect in the input.

If you set `FilterSize` using an input argument, then you can specify `FilterSize` as scalar to use the same value for both dimensions.

Example: `[5 5]` specifies filters of height 5 and width 5.

#### NumFilters — Number of filters

positive integer

Number of filters, specified as a positive integer. This number corresponds to the number of neurons in the convolutional layer that connect to the same region in the input. This parameter determines the number of channels (feature maps) in the output of the convolutional layer.

Example: 96

#### Stride — Step size for traversing input

`[1 1]` (default) | vector of two positive integers

Step size for traversing the input vertically and horizontally, specified as a vector  $[a \ b]$  of two positive integers, where  $a$  is the vertical step size and  $b$  is the horizontal step size. When creating the layer, you can specify `Stride` as a scalar to use the same value for both step sizes.

Example: `[2 3]` specifies a vertical step size of 2 and a horizontal step size of 3.

#### CroppingMode — Method to determine cropping size

'manual' (default) | 'same'

Method to determine cropping size, specified as 'manual' or same.

The software automatically sets the value of `CroppingMode` based on the 'Cropping' value you specify when creating the layer.

- If you set the 'Cropping' option to a numeric value, then the software automatically sets the `CroppingMode` property of the layer to 'manual'.
- If you set the 'Cropping' option to 'same', then the software automatically sets the `CroppingMode` property of the layer to 'same' and set the cropping so that the output size equals `inputSize .* Stride`, where `inputSize` is the height and width of the layer input.

To specify the cropping size, use the 'Cropping' option of `transposedConv2dLayer`.

### **CroppingSize — Output size reduction**

[0 0 0 0] (default) | vector of four nonnegative integers

Output size reduction, specified as a vector of four nonnegative integers [t b l r], where t, b, l, r are the amounts to crop from the top, bottom, left, and right, respectively.

To specify the cropping size manually, use the 'Cropping' option of `transposedConv2dLayer`.

Example: [0 1 0 1]

### **Cropping — Output size reduction**

[0 0] (default) | vector of two nonnegative integers

---

**Note** `Cropping` property will be removed in a future release. Use `CroppingSize` instead. To specify the cropping size manually, use the 'Cropping' option of `transposedConv2dLayer`.

---

Output size reduction, specified as a vector of two nonnegative integers [a b], where a corresponds to the cropping from the top and bottom and b corresponds to the cropping from the left and right.

To specify the cropping size manually, use the 'Cropping' option of `transposedConv2dLayer`.

Example: [0 1]

### **NumChannels — Number of channels for each filter**

'auto' (default) | integer

Number of channels for each filter, specified as 'NumChannels' and 'auto' or an integer.

This parameter must be equal to the number of channels of the input to this convolutional layer. For example, if the input is a color image, then the number of channels for the input must be 3. If the number of filters for the convolutional layer prior to the current layer is 16, then the number of channels for this layer must be 16.

### **Parameters and Initialization**

#### **WeightsInitializer — Function to initialize weights**

'glorot' (default) | 'he' | 'narrow-normal' | 'zeros' | 'ones' | function handle

Function to initialize the weights, specified as one of the following:

- 'glorot' - Initialize the weights with the Glorot initializer [1] (also known as Xavier initializer). The Glorot initializer independently samples from a uniform distribution with zero mean and

variance  $2/(\text{numIn} + \text{numOut})$ , where  $\text{numIn} = \text{FilterSize}(1) * \text{FilterSize}(2) * \text{NumChannels}$  and  $\text{numOut} = \text{FilterSize}(1) * \text{FilterSize}(2) * \text{NumFilters}$ .

- 'he' - Initialize the weights with the He initializer [2]. The He initializer samples from a normal distribution with zero mean and variance  $2/\text{numIn}$ , where  $\text{numIn} = \text{FilterSize}(1) * \text{FilterSize}(2) * \text{NumChannels}$ .
- 'narrow-normal' - Initialize the weights by independently sampling from a normal distribution with zero mean and standard deviation 0.01.
- 'zeros' - Initialize the weights with zeros.
- 'ones' - Initialize the weights with ones.
- Function handle - Initialize the weights with a custom function. If you specify a function handle, then the function must be of the form `weights = func(sz)`, where `sz` is the size of the weights. For an example, see “Specify Custom Weight Initialization Function”.

The layer only initializes the weights when the `Weights` property is empty.

Data Types: `char` | `string` | `function_handle`

### **BiasInitializer – Function to initialize bias**

'zeros' (default) | 'narrow-normal' | 'ones' | function handle

Function to initialize the bias, specified as one of the following:

- 'zeros' - Initialize the bias with zeros.
- 'ones' - Initialize the bias with ones.
- 'narrow-normal' - Initialize the bias by independently sampling from a normal distribution with zero mean and standard deviation 0.01.
- Function handle - Initialize the bias with a custom function. If you specify a function handle, then the function must be of the form `bias = func(sz)`, where `sz` is the size of the bias.

The layer only initializes the bias when the `Bias` property is empty.

Data Types: `char` | `string` | `function_handle`

### **Weights – Layer weights**

[] (default) | numeric array

Layer weights for the convolutional layer, specified as a `FilterSize(1)`-by-`FilterSize(2)`-by-`NumFilters`-by-`NumChannels` array.

The layer weights are learnable parameters. You can specify the initial value for the weights directly using the `Weights` property of the layer. When training a network, if the `Weights` property of the layer is nonempty, then `trainNetwork` uses the `Weights` property as the initial value. If the `Weights` property is empty, then `trainNetwork` uses the initializer specified by the `WeightsInitializer` property of the layer.

Data Types: `single` | `double`

### **Bias – Layer biases**

[] (default) | numeric array

Layer biases for the convolutional layer, specified as a numeric array.

The layer biases are learnable parameters. When training a network, if `Bias` is nonempty, then `trainNetwork` uses the `Bias` property as the initial value. If `Bias` is empty, then `trainNetwork` uses the initializer specified by `BiasInitializer`.

At training time, `Bias` is a 1-by-1-by-`NumFilters` array.

Data Types: `single` | `double`

### **Learn Rate and Regularization**

#### **WeightLearnRateFactor — Learning rate factor for weights**

1 (default) | nonnegative scalar

Learning rate factor for the weights, specified as a nonnegative scalar.

The software multiplies this factor by the global learning rate to determine the learning rate for the weights in this layer. For example, if `WeightLearnRateFactor` is 2, then the learning rate for the weights in this layer is twice the current global learning rate. The software determines the global learning rate based on the settings specified with the `trainingOptions` function.

Example: 2

#### **BiasLearnRateFactor — Learning rate factor for biases**

1 (default) | nonnegative scalar

Learning rate factor for the biases, specified as a nonnegative scalar.

The software multiplies this factor by the global learning rate to determine the learning rate for the biases in this layer. For example, if `BiasLearnRateFactor` is 2, then the learning rate for the biases in the layer is twice the current global learning rate. The software determines the global learning rate based on the settings specified with the `trainingOptions` function.

Example: 2

#### **WeightL2Factor — L2 regularization factor for weights**

1 (default) | nonnegative scalar

L2 regularization factor for the weights, specified as a nonnegative scalar.

The software multiplies this factor by the global L2 regularization factor to determine the L2 regularization for the weights in this layer. For example, if `WeightL2Factor` is 2, then the L2 regularization for the weights in this layer is twice the global L2 regularization factor. You can specify the global L2 regularization factor using the `trainingOptions` function.

Example: 2

#### **BiasL2Factor — L2 regularization factor for biases**

0 (default) | nonnegative scalar

L2 regularization factor for the biases, specified as a nonnegative scalar.

The software multiplies this factor by the global L2 regularization factor to determine the L2 regularization for the biases in this layer. For example, if `BiasL2Factor` is 2, then the L2 regularization for the biases in this layer is twice the global L2 regularization factor. You can specify the global L2 regularization factor using the `trainingOptions` function.

Example: 2

## Layer

### Name — Layer name

' ' (default) | character vector | string scalar

Layer name, specified as a character vector or a string scalar. To include a layer in a layer graph, you must specify a nonempty unique layer name. If you train a series network with the layer and Name is set to ' ', then the software automatically assigns a name to the layer at training time.

Data Types: char | string

### NumInputs — Number of inputs

1 (default)

Number of inputs of the layer. This layer accepts a single input only.

Data Types: double

### InputNames — Input names

{ 'in' } (default)

Input names of the layer. This layer accepts a single input only.

Data Types: cell

### NumOutputs — Number of outputs

1 (default)

Number of outputs of the layer. This layer has a single output only.

Data Types: double

### OutputNames — Output names

{ 'out' } (default)

Output names of the layer. This layer has a single output only.

Data Types: cell

## Examples

### Create Transposed Convolutional Layer

Create a transposed convolutional layer with 96 filters, each with a height and width of 11. Use a stride of 4 in the horizontal and vertical directions.

```
layer = transposedConv2dLayer(11,96,'Stride',4);
```

## Compatibility Considerations

### Default weights initialization is Glorot

*Behavior changed in R2019a*

Starting in R2019a, the software, by default, initializes the layer weights of this layer using the Glorot initializer. This behavior helps stabilize training and usually reduces the training time of deep networks.

In previous releases, the software, by default, initializes the layer weights by sampling from a normal distribution with zero mean and variance 0.01. To reproduce this behavior, set the 'WeightsInitializer' option of the layer to 'narrow-normal'.

### **Cropping property of TransposedConvolution2DLayer will be removed**

*Not recommended starting in R2019a*

Cropping property of TransposedConvolution2DLayer will be removed, use CroppingSize instead. To update your code, replace all instances of the Cropping property with CroppingSize.

## **References**

- [1] Glorot, Xavier, and Yoshua Bengio. "Understanding the difficulty of training deep feedforward neural networks." In *Proceedings of the thirteenth international conference on artificial intelligence and statistics*, pp. 249-256. 2010.
- [2] He, Kaiming, Xiangyu Zhang, Shaoqing Ren, and Jian Sun. "Delving deep into rectifiers: Surpassing human-level performance on imagenet classification." In *Proceedings of the IEEE international conference on computer vision*, pp. 1026-1034. 2015.

## **See Also**

averagePooling2dLayer | convolution2dLayer | maxPooling2dLayer |  
transposedConv2dLayer

## **Topics**

- "Create Simple Deep Learning Network for Classification"
- "Deep Learning in MATLAB"
- "Specify Layers of Convolutional Neural Network"
- "List of Deep Learning Layers"
- "Compare Layer Weight Initializers"

## **Introduced in R2017b**

# TransposedConvolution3dLayer

Transposed 3-D convolution layer

## Description

A transposed 3-D convolution layer upsamples three-dimensional feature maps.

This layer is sometimes incorrectly known as a "deconvolution" or "deconv" layer. This layer is the transpose of convolution and does not perform deconvolution.

## Creation

Create a transposed convolution 3-D output layer using `transposedConv3dLayer`.

## Properties

### Transposed Convolution

#### FilterSize — Height, width, and depth of filters

vector of three positive integers

Height, width, and depth of the filters, specified as a vector `[h w d]` of three positive integers, where `h` is the height, `w` is the width, and `d` is the depth. `FilterSize` defines the size of the local regions to which the neurons connect in the input.

When creating the layer, you can specify `FilterSize` as a scalar to use the same value for the height, width, and depth.

Example: `[5 5 5]` specifies filters with a height, width, and depth of 5.

#### NumFilters — Number of filters

positive integer

Number of filters, specified as a positive integer. This number corresponds to the number of neurons in the convolutional layer that connect to the same region in the input. This parameter determines the number of channels (feature maps) in the output of the convolutional layer.

Example: 96

#### Stride — Step size for traversing input

`[1 1 1]` (default) | vector of three positive integers

Step size for traversing the input in three dimensions, specified as a vector `[a b c]` of three positive integers, where `a` is the vertical step size, `b` is the horizontal step size, and `c` is the step size along the depth. When creating the layer, you can specify `Stride` as a scalar to use the same value for step sizes in all three directions.

Example: `[2 3 1]` specifies a vertical step size of 2, a horizontal step size of 3, and a step size along the depth of 1.

**CroppingMode — Method to determine cropping size**`'manual'` (default) | `'same'`

Method to determine cropping size, specified as `'manual'` or `'same'`.

The software automatically sets the value of `CroppingMode` based on the `'Cropping'` value you specify when creating the layer.

- If you set the `'Cropping'` option to a numeric value, then the software automatically sets the `CroppingMode` property of the layer to `'manual'`.
- If you set the `'Cropping'` option to `'same'`, then the software automatically sets the `CroppingMode` property of the layer to `'same'` and set the cropping so that the output size equals `inputSize .* Stride`, where `inputSize` is the height, width, and depth of the layer input.

To specify the cropping size, use the `'Cropping'` option of `transposedConv3dLayer`.

**CroppingSize — Output size reduction**`[0 0 0;0 0 0]` (default) | matrix of nonnegative integers

Output size reduction, specified as a matrix of nonnegative integers `[t l f; b r bk]`, `t`, `l`, `f`, `b`, `r`, `bk` are the amounts to crop from the top, left, front, bottom, right, and back of the input, respectively.

To specify the cropping size manually, use the `'Cropping'` option of `transposedConv2dLayer`.

Example: `[0 1 0 1 0 1]`

**NumChannels — Number of channels for each filter**`'auto'` (default) | integer

Number of channels for each filter, specified `'auto'` or an integer.

This parameter must be equal to the number of channels of the input to this convolutional layer. For example, if the input is a color image, then the number of channels for the input must be 3. If the number of filters for the convolutional layer prior to the current layer is 16, then the number of channels for this layer must be 16.

**Parameters and Initialization****WeightsInitializer — Function to initialize weights**`'glorot'` (default) | `'he'` | `'narrow-normal'` | `'zeros'` | `'ones'` | function handle

Function to initialize the weights, specified as one of the following:

- `'glorot'` - Initialize the weights with the Glorot initializer [1] (also known as Xavier initializer). The Glorot initializer independently samples from a uniform distribution with zero mean and variance  $2/(\text{numIn} + \text{numOut})$ , where  $\text{numIn} = \text{FilterSize}(1) * \text{FilterSize}(2) * \text{FilterSize}(3) * \text{NumChannels}$  and  $\text{numOut} = \text{FilterSize}(1) * \text{FilterSize}(2) * \text{FilterSize}(3) * \text{NumFilters}$ .
- `'he'` - Initialize the weights with the He initializer [2]. The He initializer samples from a normal distribution with zero mean and variance  $2/\text{numIn}$ , where  $\text{numIn} = \text{FilterSize}(1) * \text{FilterSize}(2) * \text{FilterSize}(3) * \text{NumChannels}$ .
- `'narrow-normal'` - Initialize the weights by independently sampling from a normal distribution with zero mean and standard deviation 0.01.



- 'zeros' - Initialize the weights with zeros.
- 'ones' - Initialize the weights with ones.
- Function handle - Initialize the weights with a custom function. If you specify a function handle, then the function must be of the form `weights = func(sz)`, where `sz` is the size of the weights. For an example, see “Specify Custom Weight Initialization Function”.

The layer only initializes the weights when the `Weights` property is empty.

Data Types: `char` | `string` | `function_handle`

### **BiasInitializer – Function to initialize bias**

'zeros' (default) | 'narrow-normal' | 'ones' | function handle

Function to initialize the bias, specified as one of the following:

- 'zeros' - Initialize the bias with zeros.
- 'ones' - Initialize the bias with ones.
- 'narrow-normal' - Initialize the bias by independently sampling from a normal distribution with zero mean and standard deviation 0.01.
- Function handle - Initialize the bias with a custom function. If you specify a function handle, then the function must be of the form `bias = func(sz)`, where `sz` is the size of the bias.

The layer only initializes the bias when the `Bias` property is empty.

Data Types: `char` | `string` | `function_handle`

### **Weights – Layer weights**

[] (default) | numeric array

Layer weights for the transposed convolutional layer, specified as a numeric array.

The layer weights are learnable parameters. You can specify the initial value for the weights directly using the `Weights` property of the layer. When training a network, if the `Weights` property of the layer is nonempty, then `trainNetwork` uses the `Weights` property as the initial value. If the `Weights` property is empty, then `trainNetwork` uses the initializer specified by the `WeightsInitializer` property of the layer.

At training time, `Weights` is a `FilterSize(1)-by-FilterSize(2)-by-FilterSize(3)-by-NumFilters-by-NumChannels` array.

Data Types: `single` | `double`

### **Bias – Layer biases**

[] (default) | numeric array

Layer biases for the transposed convolutional layer, specified as a numeric array.

The layer biases are learnable parameters. When training a network, if `Bias` is nonempty, then `trainNetwork` uses the `Bias` property as the initial value. If `Bias` is empty, then `trainNetwork` uses the initializer specified by `BiasInitializer`.

At training time, `Bias` is a `1-by-1-by-1-by-NumFilters` array.

Data Types: `single` | `double`

## Learn Rate and Regularization

### **WeightLearnRateFactor** — Learning rate factor for weights

1 (default) | nonnegative scalar

Learning rate factor for the weights, specified as a nonnegative scalar.

The software multiplies this factor by the global learning rate to determine the learning rate for the weights in this layer. For example, if `WeightLearnRateFactor` is 2, then the learning rate for the weights in this layer is twice the current global learning rate. The software determines the global learning rate based on the settings specified with the `trainingOptions` function.

Example: 2

### **BiasLearnRateFactor** — Learning rate factor for biases

1 (default) | nonnegative scalar

Learning rate factor for the biases, specified as a nonnegative scalar.

The software multiplies this factor by the global learning rate to determine the learning rate for the biases in this layer. For example, if `BiasLearnRateFactor` is 2, then the learning rate for the biases in the layer is twice the current global learning rate. The software determines the global learning rate based on the settings specified with the `trainingOptions` function.

Example: 2

### **WeightL2Factor** — L2 regularization factor for weights

1 (default) | nonnegative scalar

L2 regularization factor for the weights, specified as a nonnegative scalar.

The software multiplies this factor by the global L2 regularization factor to determine the L2 regularization for the weights in this layer. For example, if `WeightL2Factor` is 2, then the L2 regularization for the weights in this layer is twice the global L2 regularization factor. You can specify the global L2 regularization factor using the `trainingOptions` function.

Example: 2

### **BiasL2Factor** — L2 regularization factor for biases

0 (default) | nonnegative scalar

L2 regularization factor for the biases, specified as a nonnegative scalar.

The software multiplies this factor by the global L2 regularization factor to determine the L2 regularization for the biases in this layer. For example, if `BiasL2Factor` is 2, then the L2 regularization for the biases in this layer is twice the global L2 regularization factor. You can specify the global L2 regularization factor using the `trainingOptions` function.

Example: 2

## Layer

### **Name** — Layer name

' ' (default) | character vector | string scalar

Layer name, specified as a character vector or a string scalar. To include a layer in a layer graph, you must specify a nonempty unique layer name. If you train a series network with the layer and Name is set to '', then the software automatically assigns a name to the layer at training time.

Data Types: char | string

### **NumInputs — Number of inputs**

1 (default)

Number of inputs of the layer. This layer accepts a single input only.

Data Types: double

### **InputNames — Input names**

{'in'} (default)

Input names of the layer. This layer accepts a single input only.

Data Types: cell

### **NumOutputs — Number of outputs**

1 (default)

Number of outputs of the layer. This layer has a single output only.

Data Types: double

### **OutputNames — Output names**

{'out'} (default)

Output names of the layer. This layer has a single output only.

Data Types: cell

## **Examples**

### **Create Transposed 3-D Convolutional Layer**

Create a transposed 3-D convolutional layer with 32 filters, each with a height, width, and depth of 11. Use a stride of 4 in the horizontal and vertical directions and 2 along the depth.

```
layer = transposedConv3dLayer(11,32,'Stride',[4 4 2])
```

```
layer =  
    TransposedConvolution3DLayer with properties:
```

```
        Name: ''
```

```
    Hyperparameters
```

```
        FilterSize: [11 11 11]
```

```
        NumChannels: 'auto'
```

```
        NumFilters: 32
```

```
        Stride: [4 4 2]
```

```
        CroppingMode: 'manual'
```

```
        CroppingSize: [2x3 double]
```

```
    Learnable Parameters
```

```
Weights: []  
Bias: []
```

Show all properties

## References

- [1] Glorot, Xavier, and Yoshua Bengio. "Understanding the difficulty of training deep feedforward neural networks." In *Proceedings of the thirteenth international conference on artificial intelligence and statistics*, pp. 249-256. 2010.
- [2] He, Kaiming, Xiangyu Zhang, Shaoqing Ren, and Jian Sun. "Delving deep into rectifiers: Surpassing human-level performance on imagenet classification." In *Proceedings of the IEEE international conference on computer vision*, pp. 1026-1034. 2015.

## See Also

[averagePooling3dLayer](#) | [convolution3dLayer](#) | [maxPooling3dLayer](#) | [transposedConv2dLayer](#) | [transposedConv3dLayer](#)

## Topics

- "3-D Brain Tumor Segmentation Using Deep Learning"
- "Deep Learning in MATLAB"
- "Specify Layers of Convolutional Neural Network"
- "List of Deep Learning Layers"

## Introduced in R2019a

## vgg16

VGG-16 convolutional neural network

### Syntax

```
net = vgg16
net = vgg16('Weights','imagenet')

layers = vgg16('Weights','none')
```

### Description

VGG-16 is a convolutional neural network that is 16 layers deep. You can load a pretrained version of the network trained on more than a million images from the ImageNet database [1]. The pretrained network can classify images into 1000 object categories, such as keyboard, mouse, pencil, and many animals. As a result, the network has learned rich feature representations for a wide range of images. The network has an image input size of 224-by-224. For more pretrained networks in MATLAB, see “Pretrained Deep Neural Networks”.

You can use `classify` to classify new images using the VGG-16 network. Follow the steps of “Classify Image Using GoogLeNet” and replace GoogLeNet with VGG-16.

To retrain the network on a new classification task, follow the steps of “Train Deep Learning Network to Classify New Images” and load VGG-16 instead of GoogLeNet.

`net = vgg16` returns a VGG-16 network trained on the ImageNet data set.

This function requires Deep Learning Toolbox Model *for VGG-16 Network* support package. If this support package is not installed, then the function provides a download link.

`net = vgg16('Weights','imagenet')` returns a VGG-16 network trained on the ImageNet data set. This syntax is equivalent to `net = vgg16`.

`layers = vgg16('Weights','none')` returns the untrained VGG-16 network architecture. The untrained model does not require the support package.

### Examples

#### Download VGG-16 Support Package

Download and install Deep Learning Toolbox Model *for VGG-16 Network* support package.

Type `vgg16` at the command line.

```
vgg16
```

If Deep Learning Toolbox Model *for VGG-16 Network* support package is not installed, then the function provides a link to the required support package in the Add-On Explorer. To install the support package, click the link, and then click **Install**. Check that the installation is successful by typing `vgg16` at the command line.

```

vgg16
ans =
SeriesNetwork with properties:
  Layers: [41x1 nnet.cnn.layer.Layer]

```

### Load Pretrained VGG-16 Convolutional Neural Network

Load a pretrained VGG-16 convolutional neural network and examine the layers and classes.

Use `vgg16` to load the pretrained VGG-16 network. The output `net` is a `SeriesNetwork` object.

```

net = vgg16
net =
SeriesNetwork with properties:
  Layers: [41x1 nnet.cnn.layer.Layer]

```

View the network architecture using the `Layers` property. The network has 41 layers. There are 16 layers with learnable weights: 13 convolutional layers, and 3 fully connected layers.

```

net.Layers
ans =
41x1 Layer array with layers:
   1 'input'      Image Input      224x224x3 images with 'zerocenter' normalization
   2 'conv1_1'    Convolution      64 3x3x3 convolutions with stride [1 1] and padding
   3 'relu1_1'    ReLU
   4 'conv1_2'    Convolution      64 3x3x64 convolutions with stride [1 1] and padding
   5 'relu1_2'    ReLU
   6 'pool1'      Max Pooling      2x2 max pooling with stride [2 2] and padding [0 0]
   7 'conv2_1'    Convolution      128 3x3x64 convolutions with stride [1 1] and padding
   8 'relu2_1'    ReLU
   9 'conv2_2'    Convolution      128 3x3x128 convolutions with stride [1 1] and padding
  10 'relu2_2'    ReLU
  11 'pool2'      Max Pooling      2x2 max pooling with stride [2 2] and padding [0 0]
  12 'conv3_1'    Convolution      256 3x3x128 convolutions with stride [1 1] and padding
  13 'relu3_1'    ReLU
  14 'conv3_2'    Convolution      256 3x3x256 convolutions with stride [1 1] and padding
  15 'relu3_2'    ReLU
  16 'conv3_3'    Convolution      256 3x3x256 convolutions with stride [1 1] and padding
  17 'relu3_3'    ReLU
  18 'pool3'      Max Pooling      2x2 max pooling with stride [2 2] and padding [0 0]
  19 'conv4_1'    Convolution      512 3x3x256 convolutions with stride [1 1] and padding
  20 'relu4_1'    ReLU
  21 'conv4_2'    Convolution      512 3x3x512 convolutions with stride [1 1] and padding
  22 'relu4_2'    ReLU
  23 'conv4_3'    Convolution      512 3x3x512 convolutions with stride [1 1] and padding
  24 'relu4_3'    ReLU
  25 'pool4'      Max Pooling      2x2 max pooling with stride [2 2] and padding [0 0]
  26 'conv5_1'    Convolution      512 3x3x512 convolutions with stride [1 1] and padding
  27 'relu5_1'    ReLU

```

```

28 'conv5_2' Convolution 512 3x3x512 convolutions with stride [1 1] and pad
29 'relu5_2' ReLU ReLU
30 'conv5_3' Convolution 512 3x3x512 convolutions with stride [1 1] and pad
31 'relu5_3' ReLU ReLU
32 'pool5' Max Pooling 2x2 max pooling with stride [2 2] and padding [0 0]
33 'fc6' Fully Connected 4096 fully connected layer
34 'relu6' ReLU ReLU
35 'drop6' Dropout 50% dropout
36 'fc7' Fully Connected 4096 fully connected layer
37 'relu7' ReLU ReLU
38 'drop7' Dropout 50% dropout
39 'fc8' Fully Connected 1000 fully connected layer
40 'prob' Softmax softmax
41 'output' Classification Output crossentropyex with 'tench' and 999 other classes

```

To view the names of the classes learned by the network, you can view the `Classes` property of the classification output layer (the final layer). View the first 10 classes by specifying the first 10 elements.

```
net.Layers(end).Classes(1:10)
```

```
ans = 10x1 categorical array
    tench
  goldfish
great white shark
  tiger shark
  hammerhead
  electric ray
  stingray
    cock
    hen
  ostrich

```

## Output Arguments

### **net** — Pretrained VGG-16 convolutional neural network

SeriesNetwork object

Pretrained VGG-16 convolutional neural network returned as a `SeriesNetwork` object.

### **layers** — Untrained VGG-16 convolutional neural network architecture

Layer array

Untrained VGG-16 convolutional neural network architecture, returned as a `Layer` array.

## References

- [1] *ImageNet*. <http://www.image-net.org>
- [2] Russakovsky, O., Deng, J., Su, H., et al. "ImageNet Large Scale Visual Recognition Challenge." *International Journal of Computer Vision (IJCV)*. Vol 115, Issue 3, 2015, pp. 211-252
- [3] Simonyan, Karen, and Andrew Zisserman. "Very deep convolutional networks for large-scale image recognition." arXiv preprint arXiv:1409.1556 (2014).

[4] *Very Deep Convolutional Networks for Large-Scale Visual Recognition* [http://www.robots.ox.ac.uk/~vgg/research/very\\_deep/](http://www.robots.ox.ac.uk/~vgg/research/very_deep/)

## Extended Capabilities

### C/C++ Code Generation

Generate C and C++ code using MATLAB® Coder™.

For code generation, you can load the network by using the syntax `net = vgg16` or by passing the `vgg16` function to `coder.loadDeepLearningNetwork`. For example: `net = coder.loadDeepLearningNetwork('vgg16')`

For more information, see “Load Pretrained Networks for Code Generation” (MATLAB Coder).

The syntax `vgg16('Weights', 'none')` is not supported for code generation.

### GPU Code Generation

Generate CUDA® code for NVIDIA® GPUs using GPU Coder™.

Usage notes and limitations:

- For code generation, you can load the network by using the syntax `net = vgg16` or by passing the `vgg16` function to `coder.loadDeepLearningNetwork`. For example: `net = coder.loadDeepLearningNetwork('vgg16')`

For more information, see “Load Pretrained Networks for Code Generation” (GPU Coder).

- The syntax `vgg16('Weights', 'none')` is not supported for GPU code generation.

## See Also

`alexnet` | `densenet201` | `googlenet` | `inceptionresnetv2` | `resnet101` | `resnet18` | `resnet50` | `squeezenet` | `vgg19`

### Topics

“Deep Learning in MATLAB”

“Pretrained Deep Neural Networks”

“Classify Image Using GoogLeNet”

“Transfer Learning Using AlexNet”

“Visualize Activations of a Convolutional Neural Network”

### Introduced in R2017a



# vgg19

VGG-19 convolutional neural network

## Syntax

```
net = vgg19
net = vgg19('Weights','imagenet')

layers = vgg19('Weights','none')
```

## Description

VGG-19 is a convolutional neural network that is 19 layers deep. You can load a pretrained version of the network trained on more than a million images from the ImageNet database [1]. The pretrained network can classify images into 1000 object categories, such as keyboard, mouse, pencil, and many animals. As a result, the network has learned rich feature representations for a wide range of images. The network has an image input size of 224-by-224. For more pretrained networks in MATLAB, see “Pretrained Deep Neural Networks”.

You can use `classify` to classify new images using the VGG-19 network. Follow the steps of “Classify Image Using GoogLeNet” and replace GoogLeNet with VGG-19.

To retrain the network on a new classification task, follow the steps of “Train Deep Learning Network to Classify New Images” and load VGG-19 instead of GoogLeNet.

`net = vgg19` returns a VGG-19 network trained on the ImageNet data set.

This function requires Deep Learning Toolbox Model *for VGG-19 Network* support package. If this support package is not installed, then the function provides a download link.

`net = vgg19('Weights','imagenet')` returns a VGG-19 network trained on the ImageNet data set. This syntax is equivalent to `net = vgg19`.

`layers = vgg19('Weights','none')` returns the untrained VGG-19 network architecture. The untrained model does not require the support package.

## Examples

### Download VGG-19 Support Package

This example shows how to download and install Deep Learning Toolbox Model *for VGG-19 Network* support package.

Type `vgg19` at the command line.

```
vgg19
```

If Deep Learning Toolbox Model *for VGG-19 Network* support package is not installed, then the function provides a link to the required support package in the Add-On Explorer. To install the

support package, click the link, and then click **Install**. Check that the installation is successful by typing `vgg19` at the command line.

```
vgg19
```

```
ans =
```

```
SeriesNetwork with properties:
  Layers: [47x1 nnet.cnn.layer.Layer]
```

### Load Pretrained VGG-19 Convolutional Neural Network

Load a pretrained VGG-19 convolutional neural network and examine the layers and classes.

Use `vgg19` to load a pretrained VGG-19 network. The output `net` is a `SeriesNetwork` object.

```
net = vgg19
```

```
net =
```

```
SeriesNetwork with properties:
  Layers: [47x1 nnet.cnn.layer.Layer]
```

View the network architecture using the `Layers` property. The network has 47 layers. There are 19 layers with learnable weights: 16 convolutional layers, and 3 fully connected layers.

```
net.Layers
```

```
ans =
```

```
47x1 Layer array with layers:
   1 'input'      Image Input      224x224x3 images with 'zerocenter' normalization
   2 'conv1_1'    Convolution      64 3x3x3 convolutions with stride [1 1] and padding
   3 'relu_1'     ReLU             ReLU
   4 'conv1_2'    Convolution      64 3x3x64 convolutions with stride [1 1] and padding
   5 'relu_2'     ReLU             ReLU
   6 'pool1'      Max Pooling      2x2 max pooling with stride [2 2] and padding [0 0]
   7 'conv2_1'    Convolution      128 3x3x64 convolutions with stride [1 1] and padding
   8 'relu_2_1'   ReLU             ReLU
   9 'conv2_2'    Convolution      128 3x3x128 convolutions with stride [1 1] and padding
  10 'relu_2_2'   ReLU             ReLU
  11 'pool2'      Max Pooling      2x2 max pooling with stride [2 2] and padding [0 0]
  12 'conv3_1'    Convolution      256 3x3x128 convolutions with stride [1 1] and padding
  13 'relu_3_1'   ReLU             ReLU
  14 'conv3_2'    Convolution      256 3x3x256 convolutions with stride [1 1] and padding
  15 'relu_3_2'   ReLU             ReLU
  16 'conv3_3'    Convolution      256 3x3x256 convolutions with stride [1 1] and padding
  17 'relu_3_3'   ReLU             ReLU
  18 'conv3_4'    Convolution      256 3x3x256 convolutions with stride [1 1] and padding
  19 'relu_3_4'   ReLU             ReLU
  20 'pool3'      Max Pooling      2x2 max pooling with stride [2 2] and padding [0 0]
  21 'conv4_1'    Convolution      512 3x3x256 convolutions with stride [1 1] and padding
  22 'relu_4_1'   ReLU             ReLU
  23 'conv4_2'    Convolution      512 3x3x512 convolutions with stride [1 1] and padding
  24 'relu_4_2'   ReLU             ReLU
```

25	'conv4_3'	Convolution	512 3x3x512 convolutions with stride [1 1] and padding [1 1]
26	'relu4_3'	ReLU	ReLU
27	'conv4_4'	Convolution	512 3x3x512 convolutions with stride [1 1] and padding [1 1]
28	'relu4_4'	ReLU	ReLU
29	'pool4'	Max Pooling	2x2 max pooling with stride [2 2] and padding [0 0]
30	'conv5_1'	Convolution	512 3x3x512 convolutions with stride [1 1] and padding [1 1]
31	'relu5_1'	ReLU	ReLU
32	'conv5_2'	Convolution	512 3x3x512 convolutions with stride [1 1] and padding [1 1]
33	'relu5_2'	ReLU	ReLU
34	'conv5_3'	Convolution	512 3x3x512 convolutions with stride [1 1] and padding [1 1]
35	'relu5_3'	ReLU	ReLU
36	'conv5_4'	Convolution	512 3x3x512 convolutions with stride [1 1] and padding [1 1]
37	'relu5_4'	ReLU	ReLU
38	'pool5'	Max Pooling	2x2 max pooling with stride [2 2] and padding [0 0]
39	'fc6'	Fully Connected	4096 fully connected layer
40	'relu6'	ReLU	ReLU
41	'drop6'	Dropout	50% dropout
42	'fc7'	Fully Connected	4096 fully connected layer
43	'relu7'	ReLU	ReLU
44	'drop7'	Dropout	50% dropout
45	'fc8'	Fully Connected	1000 fully connected layer
46	'prob'	Softmax	softmax
47	'output'	Classification Output	crossentropyex with 'tench' and 999 other classes

To view the names of the classes learned by the network, you can view the `Classes` property of the classification output layer (the final layer). View the first 10 classes by specifying the first 10 elements.

```
net.Layers(end).Classes(1:10)
```

```
ans = 10x1 categorical array
    tench
  goldfish
great white shark
  tiger shark
  hammerhead
  electric ray
  stingray
    cock
    hen
  ostrich
```

## Output Arguments

### **net** — Pretrained VGG-19 convolutional neural network

SeriesNetwork object

Pretrained VGG-19 convolutional neural network returned as a SeriesNetwork object.

### **layers** — Untrained VGG-19 convolutional neural network architecture

Layer array

Untrained VGG-19 convolutional neural network architecture, returned as a Layer array.

## References

- [1] *ImageNet*. <http://www.image-net.org>
- [2] Russakovsky, O., Deng, J., Su, H., et al. "ImageNet Large Scale Visual Recognition Challenge." *International Journal of Computer Vision (IJCV)*. Vol 115, Issue 3, 2015, pp. 211-252
- [3] Simonyan, Karen, and Andrew Zisserman. "Very deep convolutional networks for large-scale image recognition." arXiv preprint arXiv:1409.1556 (2014).
- [4] *Very Deep Convolutional Networks for Large-Scale Visual Recognition* [http://www.robots.ox.ac.uk/~vgg/research/very\\_deep/](http://www.robots.ox.ac.uk/~vgg/research/very_deep/)

## Extended Capabilities

### C/C++ Code Generation

Generate C and C++ code using MATLAB® Coder™.

For code generation, you can load the network by using the syntax `net = vgg19` or by passing the `vgg19` function to `coder.loadDeepLearningNetwork`. For example: `net = coder.loadDeepLearningNetwork('vgg19')`

For more information, see "Load Pretrained Networks for Code Generation" (MATLAB Coder).

The syntax `vgg19('Weights', 'none')` is not supported for code generation.

### GPU Code Generation

Generate CUDA® code for NVIDIA® GPUs using GPU Coder™.

Usage notes and limitations:

- For code generation, you can load the network by using the syntax `net = vgg19` or by passing the `vgg19` function to `coder.loadDeepLearningNetwork`. For example: `net = coder.loadDeepLearningNetwork('vgg19')`

For more information, see "Load Pretrained Networks for Code Generation" (GPU Coder).

- The syntax `vgg19('Weights', 'none')` is not supported for GPU code generation.

## See Also

`alexnet` | `deepDreamImage` | `densenet201` | `googlenet` | `inceptionresnetv2` | `resnet101` | `resnet18` | `resnet50` | `squeezenet` | `vgg16`

### Topics

"Deep Learning in MATLAB"

"Pretrained Deep Neural Networks"

"Classify Image Using GoogLeNet"

"Transfer Learning Using AlexNet"

"Visualize Activations of a Convolutional Neural Network"

### Introduced in R2017a

# xception

Xception convolutional neural network

## Syntax

```
net = xception
net = xception('Weights','imagenet')

lgraph = xception('Weights','none')
```

## Description

Xception is a convolutional neural network that is 71 layers deep. You can load a pretrained version of the network trained on more than a million images from the ImageNet database [1]. The pretrained network can classify images into 1000 object categories, such as keyboard, mouse, pencil, and many animals. As a result, the network has learned rich feature representations for a wide range of images. The network has an image input size of 299-by-299. For more pretrained networks in MATLAB, see “Pretrained Deep Neural Networks”.

You can use `classify` to classify new images using the Xception model. Follow the steps of “Classify Image Using GoogLeNet” and replace GoogLeNet with Xception.

To retrain the network on a new classification task, follow the steps of “Train Deep Learning Network to Classify New Images” and load Xception instead of GoogLeNet.

`net = xception` returns an Xception network trained on the ImageNet data set.

This function requires the Deep Learning Toolbox Model *for Xception Network* support package. If this support package is not installed, then the function provides a download link.

`net = xception('Weights','imagenet')` returns an Xception network trained on the ImageNet data set. This syntax is equivalent to `net = xception`.

`lgraph = xception('Weights','none')` returns the untrained Xception network architecture. The untrained model does not require the support package.

## Examples

### Download Xception Support Package

Download and install the Deep Learning Toolbox Model *for Xception Network* support package.

Type `xception` at the command line.

```
xception
```

If the Deep Learning Toolbox Model *for Xception Network* support package is not installed, then the function provides a link to the required support package in the Add-On Explorer. To install the support package, click the link, and then click **Install**. Check that the installation is successful by

typing `xception` at the command line. If the required support package is installed, then the function returns a `DAGNetwork` object.

```
xception
ans =
    DAGNetwork with properties:
        Layers: [171x1 nnet.cnn.layer.Layer]
        Connections: [182x2 table]
```

## Output Arguments

### **net** — Pretrained Xception convolutional neural network

`DAGNetwork` object

Pretrained Xception convolutional neural network, returned as a `DAGNetwork` object.

### **lgraph** — Untrained Xception convolutional neural network architecture

`LayerGraph` object

Untrained Xception convolutional neural network architecture, returned as a `LayerGraph` object.

## References

[1] *ImageNet*. <http://www.image-net.org>

[2] Chollet, F., 2017. "Xception: Deep Learning with Depthwise Separable Convolutions." *arXiv preprint*, pp.1610-02357.

## Extended Capabilities

### **C/C++ Code Generation**

Generate C and C++ code using MATLAB® Coder™.

For code generation, you can load the network by using the syntax `net = xception` or by passing the `xception` function to `coder.loadDeepLearningNetwork`. For example: `net = coder.loadDeepLearningNetwork('xception')`

For more information, see "Load Pretrained Networks for Code Generation" (MATLAB Coder).

The syntax `xception('Weights', 'none')` is not supported for code generation.

### **GPU Code Generation**

Generate CUDA® code for NVIDIA® GPUs using GPU Coder™.

Usage notes and limitations:

- For code generation, you can load the network by using the syntax `net = xception` or by passing the `xception` function to `coder.loadDeepLearningNetwork`. For example: `net = coder.loadDeepLearningNetwork('xception')`

For more information, see "Load Pretrained Networks for Code Generation" (GPU Coder).

- The syntax `xception('Weights','none')` is not supported for GPU code generation.

## See Also

[DAGNetwork](#) | [alexnet](#) | [densenet201](#) | [googlenet](#) | [inceptionresnetv2](#) | [layerGraph](#) | [plot](#) | [resnet101](#) | [resnet50](#) | [squeezenet](#) | [trainNetwork](#) | [vgg16](#) | [vgg19](#)

## Topics

[“Deep Learning in MATLAB”](#)

[“Pretrained Deep Neural Networks”](#)

[“Classify Image Using GoogLeNet”](#)

[“Train Deep Learning Network to Classify New Images”](#)

[“Train Residual Network for Image Classification”](#)

## Introduced in R2019a





# Approximation, Clustering, and Control Functions

---

# adapt

Adapt neural network to data as it is simulated

## Syntax

```
[net,Y,E,Pf,Af,tr] = adapt(net,P,T,Pi,Ai)
```

## To Get Help

Type `help network/adapt`.

## Description

This function calculates network outputs and errors after each presentation of an input.

`[net,Y,E,Pf,Af,tr] = adapt(net,P,T,Pi,Ai)` takes

<code>net</code>	Network
<code>P</code>	Network inputs
<code>T</code>	Network targets (default = zeros)
<code>Pi</code>	Initial input delay conditions (default = zeros)
<code>Ai</code>	Initial layer delay conditions (default = zeros)

and returns the following after applying the adapt function `net.adaptFcn` with the adaption parameters `net.adaptParam`:

<code>net</code>	Updated network
<code>Y</code>	Network outputs
<code>E</code>	Network errors
<code>Pf</code>	Final input delay conditions
<code>Af</code>	Final layer delay conditions
<code>tr</code>	Training record (epoch and perf)

Note that `T` is optional and is only needed for networks that require targets. `Pi` and `Pf` are also optional and only need to be used for networks that have input or layer delays.

`adapt`'s signal arguments can have two formats: cell array or matrix.

The cell array format is easiest to describe. It is most convenient for networks with multiple inputs and outputs, and allows sequences of inputs to be presented,

<code>P</code>	<code>Ni-by-TS</code> cell array	Each element <code>P{i, ts}</code> is an <code>Ri-by-Q</code> matrix.
<code>T</code>	<code>Nt-by-TS</code> cell array	Each element <code>T{i, ts}</code> is a <code>Vi-by-Q</code> matrix.

$P_i$	$N_i$ -by-ID cell array	Each element $P_i\{i, k\}$ is an $R_i$ -by- $Q$ matrix.
$A_i$	$N_L$ -by-LD cell array	Each element $A_i\{i, k\}$ is an $S_i$ -by- $Q$ matrix.
$Y$	$N_o$ -by-TS cell array	Each element $Y\{i, ts\}$ is a $U_i$ -by- $Q$ matrix.
$E$	$N_o$ -by-TS cell array	Each element $E\{i, ts\}$ is a $U_i$ -by- $Q$ matrix.
$P_f$	$N_i$ -by-ID cell array	Each element $P_f\{i, k\}$ is an $R_i$ -by- $Q$ matrix.
$A_f$	$N_L$ -by-LD cell array	Each element $A_f\{i, k\}$ is an $S_i$ -by- $Q$ matrix.

where

$N_i$	=	<code>net.numInputs</code>
$N_L$	=	<code>net.numLayers</code>
$N_o$	=	<code>net.numOutputs</code>
ID	=	<code>net.numInputDelays</code>
LD	=	<code>net.numLayerDelays</code>
TS	=	Number of time steps
$Q$	=	Batch size
$R_i$	=	<code>net.inputs{i}.size</code>
$S_i$	=	<code>net.layers{i}.size</code>
$U_i$	=	<code>net.outputs{i}.size</code>

The columns of  $P_i$ ,  $P_f$ ,  $A_i$ , and  $A_f$  are ordered from oldest delay condition to most recent:

$P_i\{i, k\}$	=	Input $i$ at time $ts = k - ID$
$P_f\{i, k\}$	=	Input $i$ at time $ts = TS + k - ID$
$A_i\{i, k\}$	=	Layer output $i$ at time $ts = k - LD$
$A_f\{i, k\}$	=	Layer output $i$ at time $ts = TS + k - LD$

The matrix format can be used if only one time step is to be simulated ( $TS = 1$ ). It is convenient for networks with only one input and output, but can be used with networks that have more.

Each matrix argument is found by storing the elements of the corresponding cell array argument in a single matrix:

$P$	(sum of $R_i$ )-by- $Q$ matrix
$T$	(sum of $V_i$ )-by- $Q$ matrix
$P_i$	(sum of $R_i$ )-by-( $ID*Q$ ) matrix
$A_i$	(sum of $S_i$ )-by-( $LD*Q$ ) matrix
$Y$	(sum of $U_i$ )-by- $Q$ matrix
$E$	(sum of $U_i$ )-by- $Q$ matrix

Pf	(sum of Ri)-by-(ID*Q) matrix
Af	(sum of Si)-by-(LD*Q) matrix

## Examples

Here two sequences of 12 steps (where T1 is known to depend on P1) are used to define the operation of a filter.

```
p1 = {-1 0 1 0 1 1 -1 0 -1 1 0 1};
t1 = {-1 -1 1 1 1 2 0 -1 -1 0 1 1};
```

Here `linearlayer` is used to create a layer with an input range of `[-1 1]`, one neuron, input delays of 0 and 1, and a learning rate of 0.1. The linear layer is then simulated.

```
net = linearlayer([0 1],0.1);
```

Here the network adapts for one pass through the sequence.

The network's mean squared error is displayed. (Because this is the first call to `adapt`, the default `Pi` is used.)

```
[net,y,e,pf] = adapt(net,p1,t1);
mse(e)
```

Note that the errors are quite large. Here the network adapts to another 12 time steps (using the previous Pf as the new initial delay conditions).

```
p2 = {1 -1 -1 1 1 -1 0 0 0 1 -1 -1};
t2 = {2 0 -2 0 2 0 -1 0 0 1 0 -1};
[net,y,e,pf] = adapt(net,p2,t2,pf);
mse(e)
```

Here the network adapts for 100 passes through the entire sequence.

```
p3 = [p1 p2];
t3 = [t1 t2];
for i = 1:100
    [net,y,e] = adapt(net,p3,t3);
end
mse(e)
```

The error after 100 passes through the sequence is very small. The network has adapted to the relationship between the input and target signals.

## Algorithms

`adapt` calls the function indicated by `net.adaptFcn`, using the adaption parameter values indicated by `net.adaptParam`.

Given an input sequence with `TS` steps, the network is updated as follows: Each step in the sequence of inputs is presented to the network one at a time. The network's weight and bias values are updated after each step, before the next step in the sequence is presented. Thus the network is updated `TS` times.

## **See Also**

init | revert | sim | train

**Introduced before R2006a**

## adaptwb

Adapt network with weight and bias learning rules

### Syntax

```
[net,ar,Ac] = adapt(net,Pd,T,Ai)
```

### Description

This function is normally not called directly, but instead called indirectly through the function `adapt` after setting a network's adaption function (`net.adaptFcn`) to this function.

`[net,ar,Ac] = adapt(net,Pd,T,Ai)` takes these arguments,

net	Neural network
Pd	Delayed processed input states and inputs
T	Targets
Ai	Initial layer delay states

and returns

net	Neural network after adaption
ar	Adaption record
Ac	Combined initial layer states and layer outputs

### Examples

Linear layers use this adaption function. Here a linear layer with input delays of 0 and 1, and a learning rate of 0.5, is created and adapted to produce some target data `t` when given some input data `x`. The response is then plotted, showing the network's error going down over time.

```
x = {-1 0 1 0 1 1 -1 0 -1 1 0 1};
t = {-1 -1 1 1 1 2 0 -1 -1 0 1 1};
net = linearlayer([0 1],0.5);
net.adaptFcn
[net,y,e,xf] = adapt(net,x,t);
plotresponse(t,y)
```

### See Also

`adapt`

**Introduced in R2010b**

## adddelay

Add delay to neural network response

### Syntax

```
net = adddelay(net,n)
```

### Description

`net = adddelay(net,n)` takes these arguments,

net	Neural network
n	Number of delays

and returns the network with input delay connections increased, and output feedback delays decreased, by the specified number of delays `n`. The result is a network that behaves identically, except that outputs are produced `n` timesteps later.

If the number of delays `n` is not specified, a default of one delay is used.

### Examples

#### Time Delay Network

This example creates, trains, and simulates a time delay network in its original form, on an input time series `X` and target series `T`. Then the delay is removed and later added back. The first and third outputs will be identical, while the second result will include a new prediction for the following step.

```
[X,T] = simpleseries_dataset;
net1 = timedelaynet(1:2,20);
[Xs,Xi,Ai,Ts] = preparets(net1,X,T);
net1 = train(net1,Xs,Ts,Xi);
y1 = net1(Xs,Xi);
view(net1)
```

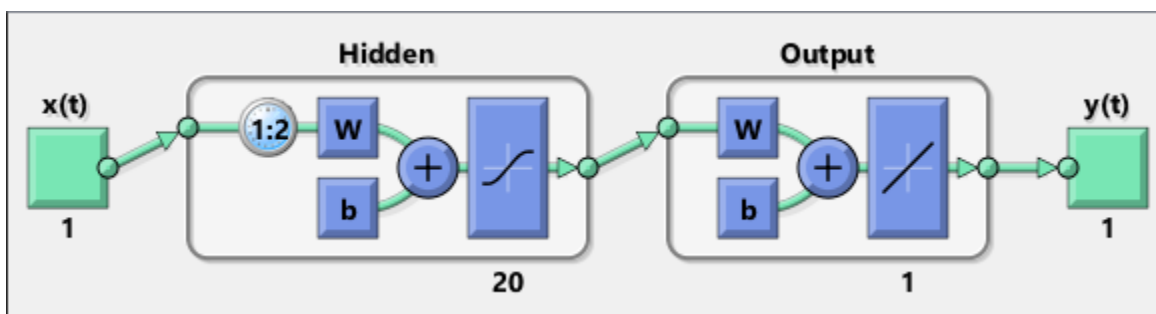

```
net2 = removedelay(net1);
[Xs,Xi,Ai,Ts] = preparets(net2,X,T);
y2 = net2(Xs,Xi);
view(net2)
```

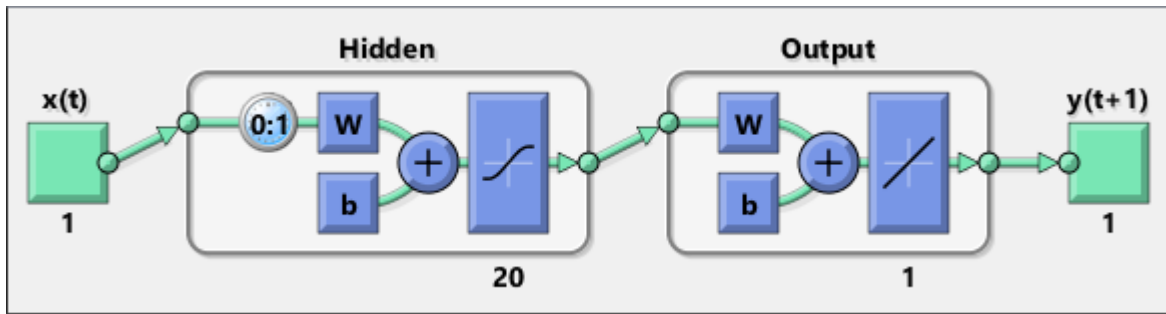

```
net3 = adddelay(net2);
[Xs,Xi,Ai,Ts] = preparets(net3,X,T);
y3 = net3(Xs,Xi);
view(net3)
```

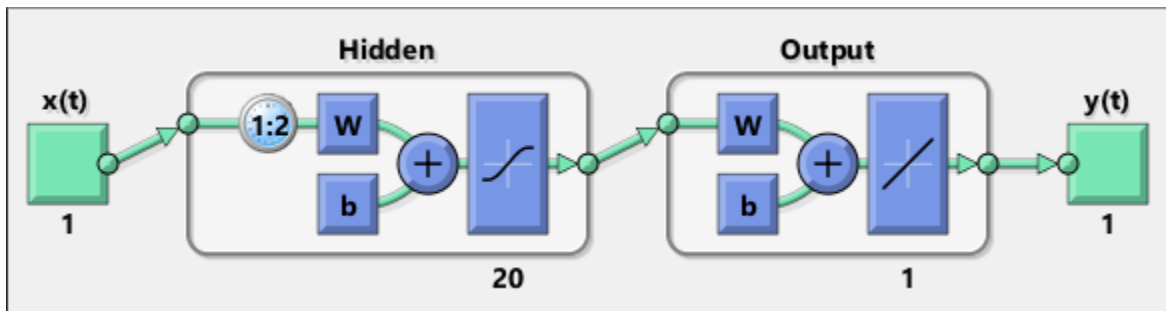

### See Also

[closeloop](#) | [openloop](#) | [removedelay](#)

Introduced in R2010b



## boxdist

Distance between two position vectors

### Syntax

```
d = boxdist(pos)
```

### Description

`boxdist` is a layer distance function that is used to find the distances between the layer's neurons, given their positions.

`d = boxdist(pos)` takes one argument,

<code>pos</code>	N-by-S matrix of neuron positions
------------------	-----------------------------------

and returns the S-by-S matrix of distances.

`boxdist` is most commonly used with layers whose topology function is `gridtop`.

### Examples

Here you define a random matrix of positions for 10 neurons arranged in three-dimensional space and then find their distances.

```
pos = rand(3,10);
d = boxdist(pos)
```

### Network Use

To change a network so that a layer's topology uses `boxdist`, set `net.layers{i}.distanceFcn` to `'boxdist'`.

In either case, call `sim` to simulate the network with `boxdist`.

### Algorithms

The box distance  $D$  between two position vectors  $P_i$  and  $P_j$  from a set of  $S$  vectors is

$$D_{ij} = \max(\text{abs}(P_i - P_j))$$

### See Also

`dist` | `linkdist` | `mandist` | `sim`

Introduced before R2006a

## bttderiv

Backpropagation through time derivative function

### Syntax

```
bttderiv('dperf_dwb',net,X,T,Xi,Ai,EW)
bttderiv('de_dwb',net,X,T,Xi,Ai,EW)
```

### Description

This function calculates derivatives using the chain rule from a network's performance back through the network, and in the case of dynamic networks, back through time.

`bttderiv('dperf_dwb',net,X,T,Xi,Ai,EW)` takes these arguments,

<code>net</code>	Neural network
<code>X</code>	Inputs, an $R \times Q$ matrix (or $N \times TS$ cell array of $R \times Q$ matrices)
<code>T</code>	Targets, an $S \times Q$ matrix (or $M \times TS$ cell array of $S \times Q$ matrices)
<code>Xi</code>	Initial input delay states (optional)
<code>Ai</code>	Initial layer delay states (optional)
<code>EW</code>	Error weights (optional)

and returns the gradient of performance with respect to the network's weights and biases, where  $R$  and  $S$  are the number of input and output elements and  $Q$  is the number of samples (and  $N$  and  $M$  are the number of input and output signals,  $R_i$  and  $S_i$  are the number of each input and outputs elements, and  $TS$  is the number of timesteps).

`bttderiv('de_dwb',net,X,T,Xi,Ai,EW)` returns the Jacobian of errors with respect to the network's weights and biases.

### Examples

Here a feedforward network is trained and both the gradient and Jacobian are calculated.

```
[x,t] = simplefit_dataset;
net = feedforwardnet(20);
net = train(net,x,t);
y = net(x);
perf = perform(net,t,y);
gwb = bttderiv('dperf_dwb',net,x,t)
jwb = bttderiv('de_dwb',net,x,t)
```

### See Also

`defaultderiv` | `fpderiv` | `num2deriv` | `num5deriv` | `staticderiv`

**Introduced in R2010b**

# cascadeforwardnet

Cascade-forward neural network

## Syntax

```
cascadeforwardnet(hiddenSizes,trainFcn)
```

## Description

Cascade-forward networks are similar to feed-forward networks, but include a connection from the input and every previous layer to following layers.

As with feed-forward networks, a two-or more layer cascade-network can learn any finite input-output relationship arbitrarily well given enough hidden neurons.

`cascadeforwardnet(hiddenSizes,trainFcn)` takes these arguments,

<code>hiddenSizes</code>	Row vector of one or more hidden layer sizes (default = 10)
<code>trainFcn</code>	Training function (default = 'trainlm')

and returns a new cascade-forward neural network.

## Examples

### Create and Train a Cascade Network

Here a cascade network is created and trained on a simple fitting problem.

```
[x,t] = simplefit_dataset;  
net = cascadeforwardnet(10);  
net = train(net,x,t);  
view(net)  
y = net(x);  
perf = perform(net,y,t)
```

```
perf =
```

```
1.9372e-05
```

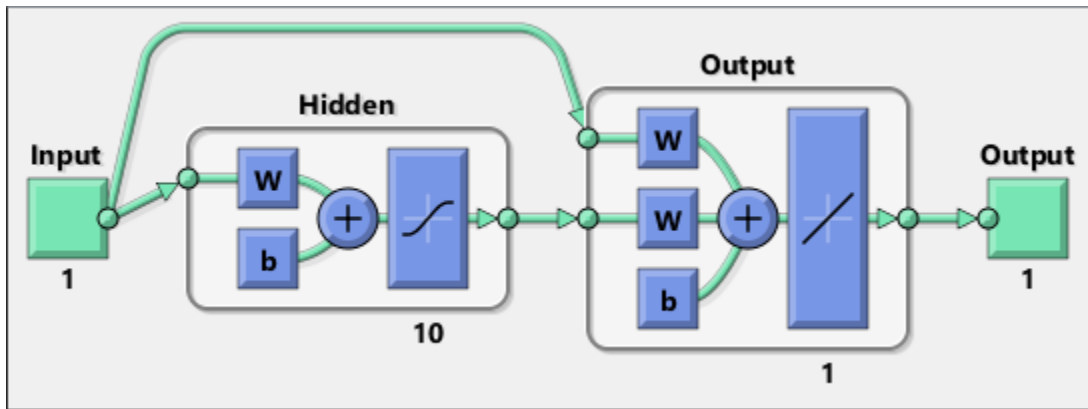

### See Also

feedforwardnet | network

### Topics

"Create, Configure, and Initialize Multilayer Shallow Neural Networks"

"Neural Network Object Properties"

"Neural Network Subobject Properties"

**Introduced in R2010b**

# catelements

Concatenate neural network data elements

## Syntax

```
catelements(x1,x2,...,xn)  
[x1; x2; ... xn]
```

## Description

`catelements(x1,x2,...,xn)` takes any number of neural network data values, and merges them along the element dimension (i.e., the matrix row dimension).

If all arguments are matrices, this operation is the same as `[x1; x2; ... xn]`.

If any argument is a cell array, then all non-cell array arguments are enclosed in cell arrays, and then the matrices in the same positions in each argument are concatenated.

## Examples

This code concatenates the elements of two matrix data values.

```
x1 = [1 2 3; 4 7 4]  
x2 = [5 8 2; 4 7 6; 2 9 1]  
y = catelements(x1,x2)
```

This code concatenates the elements of two cell array data values.

```
x1 = {[1:3; 4:6] [7:9; 10:12]; [13:15] [16:18]}  
x2 = {[2 1 3] [4 5 6]; [2 5 4] [9 7 5]}  
y = catelements(x1,x2)
```

## See Also

[catsamples](#) | [catsignals](#) | [cattimesteps](#) | [getelements](#) | [nndata](#) | [numelements](#) | [setelements](#)

**Introduced in R2010b**

## catsamples

Concatenate neural network data samples

### Syntax

```
catsamples(x1,x2,...,xn)
[x1 x2 ... xn]
catsamples(x1,x2,...,xn,'pad',v)
```

### Description

`catsamples(x1,x2,...,xn)` takes any number of neural network data values, and merges them along the samples dimension (i.e., the matrix column dimension).

If all arguments are matrices, this operation is the same as `[x1 x2 ... xn]`.

If any argument is a cell array, then all non-cell array arguments are enclosed in cell arrays, and then the matrices in the same positions in each argument are concatenated.

`catsamples(x1,x2,...,xn,'pad',v)` allows samples with varying numbers of timesteps (columns of cell arrays) to be concatenated by padding the shorter time series with the value `v`, until they are the same length as the longest series. If `v` is not specified, then the value `NaN` is used, which is often used to represent unknown or don't-care inputs or targets.

### Examples

This code concatenates the samples of two matrix data values.

```
x1 = [1 2 3; 4 7 4]
x2 = [5 8 2; 4 7 6]
y = catsamples(x1,x2)
```

This code concatenates the samples of two cell array data values.

```
x1 = {[1:3; 4:6] [7:9; 10:12]; [13:15] [16:18]}
x2 = {[2 1 3; 5 4 1] [4 5 6; 9 4 8]; [2 5 4] [9 7 5]}
y = catsamples(x1,x2)
```

Here the samples of two cell array data values, with unequal numbers of timesteps, are concatenated.

```
x1 = {1 2 3 4 5};
x2 = {10 11 12};
y = catsamples(x1,x2,'pad')
```

### See Also

[catelements](#) | [catsignals](#) | [cattimesteps](#) | [getsamples](#) | [nndata](#) | [numsamples](#) | [setsamples](#)

**Introduced in R2010b**

# catsignals

Concatenate neural network data signals

## Syntax

```
catsignals(x1,x2,...,xn)  
{x1; x2; ...; xn}
```

## Description

`catsignals(x1,x2,...,xn)` takes any number of neural network data values, and merges them along the element dimension (i.e., the cell row dimension).

If all arguments are matrices, this operation is the same as `{x1; x2; ...; xn}`.

If any argument is a cell array, then all non-cell array arguments are enclosed in cell arrays, and the cell arrays are concatenated as `[x1; x2; ...; xn]`.

## Examples

This code concatenates the signals of two matrix data values.

```
x1 = [1 2 3; 4 7 4]  
x2 = [5 8 2; 4 7 6]  
y = catsignals(x1,x2)
```

This code concatenates the signals of two cell array data values.

```
x1 = {[1:3; 4:6] [7:9; 10:12]; [13:15] [16:18]}  
x2 = {[2 1 3; 5 4 1] [4 5 6; 9 4 8]; [2 5 4] [9 7 5]}  
y = catsignals(x1,x2)
```

## See Also

[catelements](#) | [catsamples](#) | [cattimesteps](#) | [getsignals](#) | [nndata](#) | [numsignals](#) | [setsignals](#)

**Introduced in R2010b**

## cattimesteps

Concatenate neural network data timesteps

### Syntax

```
cattimesteps(x1,x2,...,xn)  
{x1 x2 ... xn}
```

### Description

`cattimesteps(x1,x2,...,xn)` takes any number of neural network data values, and merges them along the element dimension (i.e., the cell column dimension).

If all arguments are matrices, this operation is the same as `{x1 x2 ... xn}`.

If any argument is a cell array, all non-cell array arguments are enclosed in cell arrays, and the cell arrays are concatenated as `[x1 x2 ... xn]`.

### Examples

This code concatenates the elements of two matrix data values.

```
x1 = [1 2 3; 4 7 4]  
x2 = [5 8 2; 4 7 6]  
y = cattimesteps(x1,x2)
```

This code concatenates the elements of two cell array data values.

```
x1 = {[1:3; 4:6] [7:9; 10:12]; [13:15] [16:18]}  
x2 = {[2 1 3; 5 4 1] [4 5 6; 9 4 8]; [2 5 4] [9 7 5]}  
y = cattimesteps(x1,x2)
```

### See Also

`catelements` | `catsamples` | `catsignals` | `gettimesteps` | `nndata` | `numtimesteps` | `setimesteps`

**Introduced in R2010b**



# cellmat

Create cell array of matrices

## Syntax

```
cellmat(A,B,C,D,v)
```

## Description

`cellmat(A,B,C,D,v)` takes four integer values and one scalar value `v`, and returns an `A`-by-`B` cell array of `C`-by-`D` matrices of value `v`. If the value `v` is not specified, zero is used.

## Examples

Here two cell arrays of matrices are created.

```
cm1 = cellmat(2,3,5,4)
cm2 = cellmat(3,4,2,2,pi)
```

## See Also

`nndata`

**Introduced in R2010b**

## closeloop

Convert neural network open-loop feedback to closed loop

### Syntax

```
net = closeloop(net)
[net,xi,ai] = closeloop(net,xi,ai)
```

### Description

`net = closeloop(net)` takes a neural network and closes any open-loop feedback. For each feedback output `i` whose property `net.outputs{i}.feedbackMode` is 'open', it replaces its associated feedback input and their input weights with layer weight connections coming from the output. The `net.outputs{i}.feedbackMode` property is set to 'closed', and the `net.outputs{i}.feedbackInput` property is set to an empty matrix. Finally, the value of `net.outputs{i}.feedbackDelays` is added to the delays of the feedback layer weights (i.e., to the delays values of the replaced input weights).

`[net,xi,ai] = closeloop(net,xi,ai)` converts an open-loop network and its current input delay states `xi` and layer delay states `ai` to closed-loop form.

### Examples

#### Convert NARX Network to Closed-Loop Form

This example shows how to design a NARX network in open-loop form, then convert it to closed-loop form.

```
[X,T] = simplenarx_dataset;
net = narxnet(1:2,1:2,10);
[Xs,Xi,Ai,Ts] = preparets(net,X,{},T);
net = train(net,Xs,Ts,Xi,Ai);
view(net)
Yopen = net(Xs,Xi,Ai)
net = closeloop(net)
view(net)
[Xs,Xi,Ai,Ts] = preparets(net,X,{},T);
Yclosed = net(Xs,Xi,Ai);
```

#### Convert Delay States

For examples on using `closeloop` and `openloop` to implement multistep prediction, see `narxnet` and `narnet`.

### See Also

`narnet` | `narxnet` | `noloop` | `openloop`

**Introduced in R2010b**

## combvec

Create all combinations of vectors

### Syntax

```
combvec(A1,A2,...)
```

### Description

combvec(A1,A2,...) takes any number of inputs,

A1	Matrix of N1 (column) vectors
A2	Matrix of N2 (column) vectors

and returns a matrix of (N1\*N2\*...) column vectors, where the columns consist of all possibilities of A2 vectors, appended to A1 vectors.

### Examples

```
a1 = [1 2 3; 4 5 6];
a2 = [7 8; 9 10];
a3 = combvec(a1,a2)
```

a3 =

```

     1     2     3     1     2     3
     4     5     6     4     5     6
     7     7     7     8     8     8
     9     9     9    10    10    10
```

**Introduced before R2006a**

## compet

Competitive transfer function

### Graph and Symbol

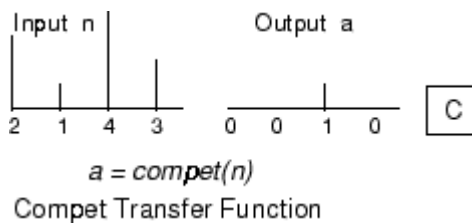

### Syntax

```
A = compet(N,FP)
info = compet('code')
```

### Description

`compet` is a neural transfer function. Transfer functions calculate a layer's output from its net input.

$A = \text{compet}(N, FP)$  takes  $N$  and optional function parameters,

$N$	S-by-Q matrix of net input (column) vectors
$FP$	Struct of function parameters (ignored)

and returns the S-by-Q matrix  $A$  with a 1 in each column where the same column of  $N$  has its maximum value, and 0 elsewhere.

`info = compet('code')` returns information according to the code string specified:

`compet('name')` returns the name of this function.

`compet('output',FP)` returns the [min max] output range.

`compet('active',FP)` returns the [min max] active input range.

`compet('fullderiv')` returns 1 or 0, depending on whether  $dA_{dN}$  is S-by-S-by-Q or S-by-Q.

`compet('fpnames')` returns the names of the function parameters.

`compet('fpdefaults')` returns the default function parameters.

### Examples

Here you define a net input vector  $N$ , calculate the output, and plot both with bar graphs.

```
n = [0; 1; -0.5; 0.5];
a = compet(n);
```

```
subplot(2,1,1), bar(n), ylabel('n')  
subplot(2,1,2), bar(a), ylabel('a')
```

Assign this transfer function to layer *i* of a network.

```
net.layers{i}.transferFcn = 'compet';
```

## **See Also**

`sim` | `softmax`

**Introduced before R2006a**

## competlayer

Competitive layer

### Syntax

```
competlayer(numClasses, kohonenLR, conscienceLR)
```

### Description

Competitive layers learn to classify input vectors into a given number of classes, according to similarity between vectors, with a preference for equal numbers of vectors per class.

`competlayer(numClasses, kohonenLR, conscienceLR)` takes these arguments,

<code>numClasses</code>	Number of classes to classify inputs (default = 5)
<code>kohonenLR</code>	Learning rate for Kohonen weights (default = 0.01)
<code>conscienceLR</code>	Learning rate for conscience bias (default = 0.001)

and returns a competitive layer with `numClasses` neurons.

### Examples

#### Create and Train a Competitive Layer

Here a competitive layer is trained to classify 150 iris flowers into 6 classes.

```
inputs = iris_dataset;
net = competlayer(6);
net = train(net, inputs);
view(net)
outputs = net(inputs);
classes = vec2ind(outputs);
```

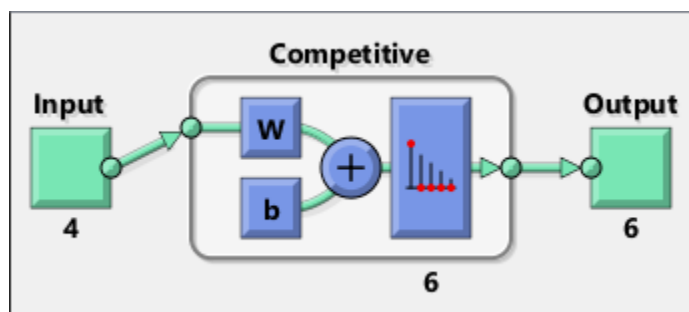

### See Also

`lvqnet` | `patternnet` | `selforgmap`

Introduced in R2010b

## con2seq

Convert concurrent vectors to sequential vectors

### Syntax

```
S = con2seq(b)
S = con2seq(b,TS)
```

### Description

Deep Learning Toolbox software arranges concurrent vectors with a matrix, and sequential vectors with a cell array (where the second index is the time step).

con2seq and seq2con allow concurrent vectors to be converted to sequential vectors, and back again.

`S = con2seq(b)` takes one input,

b	R-by-TS matrix
---	----------------

and returns one output,

S	1-by-TS cell array of R-by-1 vectors
---	--------------------------------------

`S = con2seq(b,TS)` can also convert multiple batches,

b	N-by-1 cell array of matrices with M*TS columns
TS	Time steps

and returns

S	N-by-TS cell array of matrices with M columns
---	---

### Examples

Here a batch of three values is converted to a sequence.

```
p1 = [1 4 2]
p2 = con2seq(p1)
```

Here, two batches of vectors are converted to two sequences with two time steps.

```
p1 = {[1 3 4 5; 1 1 7 4]; [7 3 4 4; 6 9 4 1]}
p2 = con2seq(p1,2)
```

### See Also

concur | seq2con

**Introduced before R2006a**



## concur

Create concurrent bias vectors

### Syntax

```
concur(B,Q)
```

### Description

```
concur(B,Q)
```

B	S-by-1 bias vector (or an N1-by-1 cell array of vectors)
Q	Concurrent size

and returns an S-by-B matrix of copies of B (or an N1-by-1 cell array of matrices).

### Examples

Here `concur` creates three copies of a bias vector.

```
b = [1; 3; 2; -1];
concur(b,3)
```

### Network Use

To calculate a layer's net input, the layer's weighted inputs must be combined with its biases. The following expression calculates the net input for a layer with the `netsum` net input function, two input weights, and a bias:

```
n = netsum(z1,z2,b)
```

The above expression works if Z1, Z2, and B are all S-by-1 vectors. However, if the network is being simulated by `sim` (or `adapt` or `train`) in response to Q concurrent vectors, then Z1 and Z2 will be S-by-Q matrices. Before B can be combined with Z1 and Z2, you must make Q copies of it.

```
n = netsum(z1,z2,concur(b,q))
```

### See Also

`con2seq` | `netprod` | `netsum` | `seq2con` | `sim`

**Introduced before R2006a**

## configure

Configure network inputs and outputs to best match input and target data

### Syntax

```
net = configure(net,x,t)
net = configure(net,x)
net = configure(net,'inputs',x,i)
net = configure(net,'outputs',t,i)
```

### Description

Configuration is the process of setting network input and output sizes and ranges, input preprocessing settings and output postprocessing settings, and weight initialization settings to match input and target data.

Configuration must happen before a network's weights and biases can be initialized. Unconfigured networks are automatically configured and initialized the first time `train` is called. Alternately, a network can be configured manually either by calling this function or by setting a network's input and output sizes, ranges, processing settings, and initialization settings properties manually.

`net = configure(net,x,t)` takes input data `x` and target data `t`, and configures the network's inputs and outputs to match.

`net = configure(net,x)` configures only inputs.

`net = configure(net,'inputs',x,i)` configures the inputs specified with the index vector `i`. If `i` is not specified all inputs are configured.

`net = configure(net,'outputs',t,i)` configures the outputs specified with the index vector `i`. If `i` is not specified all targets are configured.

### Examples

Here a feedforward network is created and manually configured for a simple fitting problem (as opposed to allowing `train` to configure it).

```
[x,t] = simplefit_dataset;
net = feedforwardnet(20); view(net)
net = configure(net,x,t); view(net)
```

### See Also

`init` | `isconfigured` | `train` | `unconfigure`

**Introduced in R2010b**

# confusion

Classification confusion matrix

## Syntax

```
[c,cm,ind,per] = confusion(targets,outputs)
```

## Description

[c,cm,ind,per] = confusion(targets,outputs) takes these values:

targets	S-by-Q matrix, where each column vector contains a single 1 value, with all other elements 0. The index of the 1 indicates which of S categories that vector represents.
outputs	S-by-Q matrix, where each column contains values in the range [0, 1]. The index of the largest element in the column indicates which of S categories that vector represents.

and returns these values:

c	Confusion value = fraction of samples misclassified
cm	S-by-S confusion matrix, where $cm(i, j)$ is the number of samples whose target is the $i$ th class that was classified as $j$
ind	S-by-S cell array, where $ind\{i, j\}$ contains the indices of samples with the $i$ th target class, but $j$ th output class
per	S-by-4 matrix, where each row summarizes four percentages associated with the $i$ th class: $per(i,1)$ false negative rate $= (\text{false negatives})/(\text{all output negatives})$ $per(i,2)$ false positive rate $= (\text{false positives})/(\text{all output positives})$ $per(i,3)$ true positive rate $= (\text{true positives})/(\text{all output positives})$ $per(i,4)$ true negative rate $= (\text{true negatives})/(\text{all output negatives})$

[c,cm,ind,per] = confusion(TARGETS,OUTPUTS) takes these values:

targets	1-by-Q vector of 1/0 values representing membership
outputs	S-by-Q matrix, of value in [0, 1] interval, where values greater than or equal to 0.5 indicate class membership

and returns these values:

c	Confusion value = fraction of samples misclassified
cm	2-by-2 confusion matrix

ind	2-by-2 cell array, where <code>ind{i,j}</code> contains the indices of samples whose target is 1 versus 0, and whose output was greater than or equal to 0.5 versus less than 0.5
per	2-by-4 matrix where each <code>i</code> th row represents the percentage of false negatives, false positives, true positives, and true negatives for the class and out-of-class

## Examples

```
[x,t] = simpleclass_dataset;  
net = patternnet(10);  
net = train(net,x,t);  
y = net(x);  
[c,cm,ind,per] = confusion(t,y)
```

## See Also

`plotconfusion` | `roc`

**Introduced in R2008a**

# convwf

Convolution weight function

## Syntax

```
Z = convwf(W,P)
dim = convwf('size',S,R,FP)
dw = convwf('dw',W,P,Z,FP)
info = convwf('code')
```

## Description

Weight functions apply weights to an input to get weighted inputs.

`Z = convwf(W,P)` returns the convolution of a weight matrix `W` and an input `P`.

`dim = convwf('size',S,R,FP)` takes the layer dimension `S`, input dimension `R`, and function parameters, and returns the weight size.

`dw = convwf('dw',W,P,Z,FP)` returns the derivative of `Z` with respect to `W`.

`info = convwf('code')` returns information about this function. The following codes are defined:

'deriv'	Name of derivative function
'fullderiv'	Reduced derivative = 2, full derivative = 1, linear derivative = 0
'pfullderiv'	Input: reduced derivative = 2, full derivative = 1, linear derivative = 0
'wfullderiv'	Weight: reduced derivative = 2, full derivative = 1, linear derivative = 0
'name'	Full name
'fpnames'	Returns names of function parameters
'fpdefaults'	Returns default function parameters

## Examples

Here you define a random weight matrix `W` and input vector `P` and calculate the corresponding weighted input `Z`.

```
W = rand(4,1);
P = rand(8,1);
Z = convwf(W,P)
```

## Network Use

To change a network so an input weight uses `convwf`, set `net.inputWeights{i,j}.weightFcn` to `'convwf'`. For a layer weight, set `net.layerWeights{i,j}.weightFcn` to `'convwf'`.

In either case, call `sim` to simulate the network with `convwf`.

**Introduced in R2006a**

# crossentropy

Neural network performance

## Syntax

```
perf = crossentropy(net,targets,outputs,perfWeights)
perf = crossentropy( ___,Name,Value)
```

## Description

`perf = crossentropy(net,targets,outputs,perfWeights)` calculates a network performance given targets and outputs, with optional performance weights and other parameters. The function returns a result that heavily penalizes outputs that are extremely inaccurate ( $y$  near  $1-t$ ), with very little penalty for fairly correct classifications ( $y$  near  $t$ ). Minimizing cross-entropy leads to good classifiers.

The cross-entropy for each pair of output-target elements is calculated as:  $ce = -t .* \log(y)$ .

The aggregate cross-entropy performance is the mean of the individual values:  $perf = \text{sum}(ce(:))/\text{numel}(ce)$ .

Special case ( $N = 1$ ): If an output consists of only one element, then the outputs and targets are interpreted as binary encoding. That is, there are two classes with targets of 0 and 1, whereas in 1-of- $N$  encoding, there are two or more classes. The binary cross-entropy expression is:  $ce = -t .* \log(y) - (1-t) .* \log(1-y)$ .

`perf = crossentropy( ___,Name,Value)` supports customization according to the specified name-value pair arguments.

## Examples

### Calculate Network Performance

This example shows how to design a classification network with cross-entropy and 0.1 regularization, then calculate performance on the whole dataset.

```
[x,t] = iris_dataset;
net = patternnet(10);
net.performParam.regularization = 0.1;
net = train(net,x,t);
y = net(x);
perf = crossentropy(net,t,y,{1},'regularization',0.1)

perf = 0.0267
```

### Set crossentropy as Performance Function

This example shows how to set up the network to use the `crossentropy` during training.

```
net = feedforwardnet(10);  
net.performFcn = 'crossentropy';  
net.performParam.regularization = 0.1;  
net.performParam.normalization = 'none';
```

## Input Arguments

### **net** — neural network

network object

Neural network, specified as a network object.

Example: `net = feedforwardnet(10);`

### **targets** — neural network target values

matrix or cell array of numeric values

Neural network target values, specified as a matrix or cell array of numeric values. Network target values define the desired outputs, and can be specified as an  $N$ -by- $Q$  matrix of  $Q$   $N$ -element vectors, or an  $M$ -by- $TS$  cell array where each element is an  $N_i$ -by- $Q$  matrix. In each of these cases,  $N$  or  $N_i$  indicates a vector length,  $Q$  the number of samples,  $M$  the number of signals for neural networks with multiple outputs, and  $TS$  is the number of time steps for time series data. `targets` must have the same dimensions as `outputs`.

The target matrix columns consist of all zeros and a single 1 in the position of the class being represented by that column vector. When  $N = 1$ , the software uses cross entropy for binary encoding, otherwise it uses cross entropy for 1-of- $N$  encoding. NaN values are allowed to indicate unknown or don't-care output values. The performance of NaN target values is ignored.

Data Types: `double` | `cell`

### **outputs** — neural network output values

matrix or cell array of numeric values

Neural network output values, specified as a matrix or cell array of numeric values. Network output values can be specified as an  $N$ -by- $Q$  matrix of  $Q$   $N$ -element vectors, or an  $M$ -by- $TS$  cell array where each element is an  $N_i$ -by- $Q$  matrix. In each of these cases,  $N$  or  $N_i$  indicates a vector length,  $Q$  the number of samples,  $M$  the number of signals for neural networks with multiple outputs and  $TS$  is the number of time steps for time series data. `outputs` must have the same dimensions as `targets`.

Outputs can include NaN to indicate unknown output values, presumably produced as a result of NaN input values (also representing unknown or don't-care values). The performance of NaN output values is ignored.

General case ( $N \geq 2$ ): The columns of the output matrix represent estimates of class membership, and should sum to 1. You can use the `softmax` transfer function to produce such output values. Use `patternnet` to create networks that are already set up to use cross-entropy performance with a softmax output layer.

Data Types: `double` | `cell`

### **perfWeights** — performance weights

{1} (default) | vector or cell array of numeric values

Performance weights, specified as a vector or cell array of numeric values. Performance weights are an optional argument defining the importance of each performance value, associated with each target



value, using values between 0 and 1. Performance values of 0 indicate targets to ignore, values of 1 indicate targets to be treated with normal importance. Values between 0 and 1 allow targets to be treated with relative importance.

Performance weights have many uses. They are helpful for classification problems, to indicate which classifications (or misclassifications) have relatively greater benefits (or costs). They can be useful in time series problems where obtaining a correct output on some time steps, such as the last time step, is more important than others. Performance weights can also be used to encourage a neural network to best fit samples whose targets are known most accurately, while giving less importance to targets which are known to be less accurate.

`perfWeights` can have the same dimensions as `targets` and `outputs`. Alternately, each dimension of the performance weights can either match the dimension of `targets` and `outputs`, or be 1. For instance, if `targets` is an N-by-Q matrix defining Q samples of N-element vectors, the performance weights can be N-by-Q indicating a different importance for each target value, or N-by-1 defining a different importance for each row of the targets, or 1-by-Q indicating a different importance for each sample, or be the scalar 1 (i.e. 1-by-1) indicating the same importance for all target values.

Similarly, if `outputs` and `targets` are cell arrays of matrices, the `perfWeights` can be a cell array of the same size, a row cell array (indicating the relative importance of each time step), a column cell array (indicating the relative importance of each neural network output), or a cell array of a single matrix or just the matrix (both cases indicating that all matrices have the same importance values).

For any problem, a `perfWeights` value of `{1}` (the default) or the scalar 1 indicates all performances have equal importance.

Data Types: `double` | `cell`

### Name-Value Pair Arguments

Specify optional comma-separated pairs of `Name`, `Value` arguments. `Name` is the argument name and `Value` is the corresponding value. `Name` must appear inside quotes. You can specify several name and value pair arguments in any order as `Name1, Value1, ..., NameN, ValueN`.

Example: `'normalization', 'standard'` specifies the inputs and targets to be normalized to the range (-1,+1).

### regularization — proportion of performance attributed to weight/bias values

0 (default) | numeric value in the range (0,1)

Proportion of performance attributed to weight/bias values, specified as a double between 0 (the default) and 1. A larger value penalizes the network for large weights, and the more likely the network function will avoid overfitting.

Example: `'regularization', 0`

Data Types: `single` | `double`

### normalization — Normalization mode for outputs, targets, and errors

'none' (default) | 'standard' | 'percent'

Normalization mode for outputs, targets, and errors, specified as `'none'`, `'standard'`, or `'percent'`. `'none'` performs no normalization. `'standard'` results in outputs and targets being normalized to (-1, +1), and therefore errors in the range (-2, +2). `'percent'` normalizes outputs and targets to (-0.5, 0.5) and errors to (-1, 1).

Example: `'normalization', 'standard'`

Data Types: char

## **Output Arguments**

### **perf — network performance**

double

Network performance, returned as a double in the range (0,1).

### **See Also**

mae | mse | patternnet | sae | softmax | sse

**Introduced in R2013b**

# defaultderiv

Default derivative function

## Syntax

```
defaultderiv('dperf_dwb',net,X,T,Xi,Ai,EW)
defaultderiv('de_dwb',net,X,T,Xi,Ai,EW)
```

## Description

This function chooses the recommended derivative algorithm for the type of network whose derivatives are being calculated. For static networks, `defaultderiv` calls `staticderiv`; for dynamic networks it calls `bttderiv` to calculate the gradient and `fpderiv` to calculate the Jacobian.

`defaultderiv('dperf_dwb',net,X,T,Xi,Ai,EW)` takes these arguments,

<code>net</code>	Neural network
<code>X</code>	Inputs, an R-by-Q matrix (or N-by-TS cell array of Ri-by-Q matrices)
<code>T</code>	Targets, an S-by-Q matrix (or M-by-TS cell array of Si-by-Q matrices)
<code>Xi</code>	Initial input delay states (optional)
<code>Ai</code>	Initial layer delay states (optional)
<code>EW</code>	Error weights (optional)

and returns the gradient of performance with respect to the network's weights and biases, where R and S are the number of input and output elements and Q is the number of samples (or N and M are the number of input and output signals, Ri and Si are the number of each input and outputs elements, and TS is the number of timesteps).

`defaultderiv('de_dwb',net,X,T,Xi,Ai,EW)` returns the Jacobian of errors with respect to the network's weights and biases.

## Examples

Here a feedforward network is trained and both the gradient and Jacobian are calculated.

```
[x,t] = simplefit_dataset;
net = feedforwardnet(10);
net = train(net,x,t);
y = net(x);
perf = perform(net,t,y);
dwb = defaultderiv('dperf_dwb',net,x,t)
```

## See Also

`bttderiv` | `fpderiv` | `num2deriv` | `num5deriv` | `staticderiv`

**Introduced in R2010b**

## dist

Euclidean distance weight function

### Syntax

```
Z = dist(W,P,FP)
dim = dist('size',S,R,FP)
dw = dist('dw',W,P,Z,FP)
D = dist(pos)
info = dist('code')
```

### Description

Weight functions apply weights to an input to get weighted inputs.

`Z = dist(W,P,FP)` takes these inputs,

W	S-by-R weight matrix
P	R-by-Q matrix of Q input (column) vectors
FP	Struct of function parameters (optional, ignored)

and returns the S-by-Q matrix of vector distances.

`dim = dist('size',S,R,FP)` takes the layer dimension S, input dimension R, and function parameters, and returns the weight size [S-by-R].

`dw = dist('dw',W,P,Z,FP)` returns the derivative of Z with respect to W.

`dist` is also a layer distance function which can be used to find the distances between neurons in a layer.

`D = dist(pos)` takes one argument,

pos	N-by-S matrix of neuron positions
-----	-----------------------------------

and returns the S-by-S matrix of distances.

`info = dist('code')` returns information about this function. The following codes are supported:

'deriv'	Name of derivative function
'fullderiv'	Full derivative = 1, linear derivative = 0
'pfullderiv'	Input: reduced derivative = 2, full derivative = 1, linear derivative = 0
'name'	Full name
'fpnames'	Returns names of function parameters
'fpdefaults'	Returns default function parameters

## Examples

Here you define a random weight matrix *W* and input vector *P* and calculate the corresponding weighted input *Z*.

```
W = rand(4,3);  
P = rand(3,1);  
Z = dist(W,P)
```

Here you define a random matrix of positions for 10 neurons arranged in three-dimensional space and find their distances.

```
pos = rand(3,10);  
D = dist(pos)
```

## Network Use

You can create a standard network that uses `dist` by calling `newpnn` or `newgrnn`.

To change a network so an input weight uses `dist`, set `net.inputWeights{i,j}.weightFcn` to `'dist'`. For a layer weight, set `net.layerWeights{i,j}.weightFcn` to `'dist'`.

To change a network so that a layer's topology uses `dist`, set `net.layers{i}.distanceFcn` to `'dist'`.

In either case, call `sim` to simulate the network with `dist`.

See `newpnn` or `newgrnn` for simulation examples.

## Algorithms

The Euclidean distance *d* between two vectors *X* and *Y* is

$$d = \text{sum}((x-y).^2).^0.5$$

## See Also

`dotprod` | `linkdist` | `mandist` | `negdist` | `normprod` | `sim`

**Introduced before R2006a**

## distdelaynet

Distributed delay network

### Syntax

```
distdelaynet(delays,hiddenSizes,trainFcn)
```

### Description

Distributed delay networks are similar to feedforward networks, except that each input and layer weights has a tap delay line associated with it. This allows the network to have a finite dynamic response to time series input data. This network is also similar to the time delay neural network (`timedelaynet`), which only has delays on the input weight.

`distdelaynet(delays,hiddenSizes,trainFcn)` takes these arguments,

<code>delays</code>	Row vector of increasing 0 or positive delays (default = 1:2)
<code>hiddenSizes</code>	Row vector of one or more hidden layer sizes (default = 10)
<code>trainFcn</code>	Training function (default = 'trainlm')

and returns a distributed delay neural network.

### Examples

#### Distributed Delay Network

Here a distributed delay neural network is used to solve a simple time series problem.

```
[X,T] = simpleseries_dataset;
net = distdelaynet({1:2,1:2},10);
[Xs,Xi,Ai,Ts] = preparets(net,X,T);
net = train(net,Xs,Ts,Xi,Ai);
view(net)
Y = net(Xs,Xi,Ai);
perf = perform(net,Y,Ts)
```

```
perf =
```

```
0.0323
```

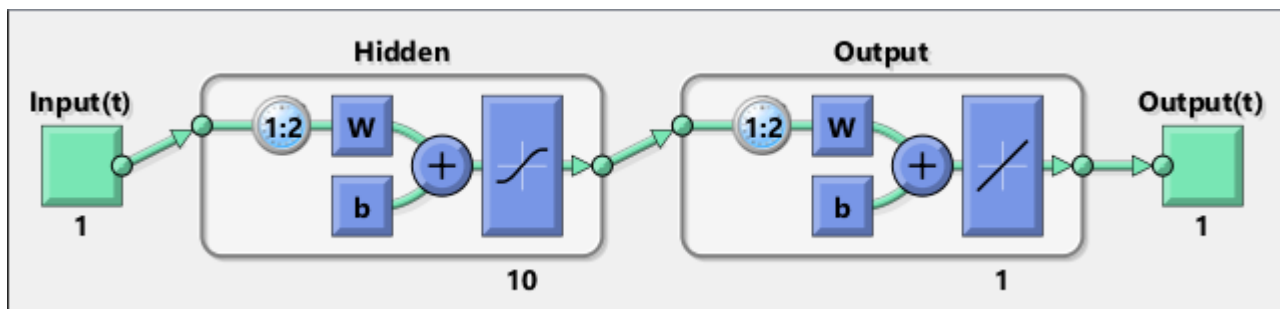

## **See Also**

narnet | narxnet | preparets | removedelay | timedelaynet

**Introduced in R2010b**

## divideblock

Divide targets into three sets using blocks of indices

### Syntax

```
[trainInd, valInd, testInd] = divideblock(Q, trainRatio, valRatio, testRatio)
```

### Description

`[trainInd, valInd, testInd] = divideblock(Q, trainRatio, valRatio, testRatio)` separates targets into three sets: training, validation, and testing. It takes the following inputs:

<code>Q</code>	Number of targets to divide up.
<code>trainRatio</code>	Ratio of targets for training. Default = 0.7.
<code>valRatio</code>	Ratio of targets for validation. Default = 0.15.
<code>testRatio</code>	Ratio of targets for testing. Default = 0.15.

and returns

<code>trainInd</code>	Training indices
<code>valInd</code>	Validation indices
<code>testInd</code>	Test indices

### Examples

```
[trainInd, valInd, testInd] = divideblock(3000, 0.6, 0.2, 0.2);
```

### Network Use

Here are the network properties that define which data division function to use, what its parameters are, and what aspects of targets are divided up, when `train` is called.

```
net.divideFcn  
net.divideParam  
net.divideMode
```

### See Also

`divideind` | `divideint` | `dividerand` | `dividetrain`

**Introduced in R2008a**



## divideind

Divide targets into three sets using specified indices

### Syntax

```
[trainInd, valInd, testInd] = divideind(Q, trainInd, valInd, testInd)
```

### Description

`[trainInd, valInd, testInd] = divideind(Q, trainInd, valInd, testInd)` separates targets into three sets: training, validation, and testing, according to indices provided. It actually returns the same indices it receives as arguments; its purpose is to allow the indices to be used for training, validation, and testing for a network to be set manually.

It takes the following inputs,

Q	Number of targets to divide up
trainInd	Training indices
valInd	Validation indices
testInd	Test indices

and returns

trainInd	Training indices (unchanged)
valInd	Validation indices (unchanged)
testInd	Test indices (unchanged)

### Examples

```
[trainInd, valInd, testInd] = ...
divideind(3000, 1:2000, 2001:2500, 2501:3000);
```

### Network Use

Here are the network properties that define which data division function to use, what its parameters are, and what aspects of targets are divided up, when `train` is called.

```
net.divideFcn
net.divideParam
net.divideMode
```

### See Also

`divideblock` | `divideint` | `dividerand` | `dividetrain`

**Introduced in R2008a**

## divideint

Divide targets into three sets using interleaved indices

### Syntax

```
[trainInd,valInd,testInd] = divideint(Q,trainRatio,valRatio,testRatio)
```

### Description

`[trainInd,valInd,testInd] = divideint(Q,trainRatio,valRatio,testRatio)` separates targets into three sets: training, validation, and testing. It takes the following inputs,

<code>Q</code>	Number of targets to divide up.
<code>trainRatio</code>	Ratio of vectors for training. Default = 0.7.
<code>valRatio</code>	Ratio of vectors for validation. Default = 0.15.
<code>testRatio</code>	Ratio of vectors for testing. Default = 0.15.

and returns

<code>trainInd</code>	Training indices
<code>valInd</code>	Validation indices
<code>testInd</code>	Test indices

### Examples

```
[trainInd,valInd,testInd] = divideint(3000,0.6,0.2,0.2);
```

### Network Use

Here are the network properties that define which data division function to use, what its parameters are, and what aspects of targets are divided up, when `train` is called.

```
net.divideFcn  
net.divideParam  
net.divideMode
```

### See Also

`divideblock` | `divideind` | `dividerand` | `dividetrain`

**Introduced in R2008a**

# dividerand

Divide targets into three sets using random indices

## Syntax

```
[trainInd, valInd, testInd] = dividerand(Q, trainRatio, valRatio, testRatio)
```

## Description

[trainInd, valInd, testInd] = dividerand(Q, trainRatio, valRatio, testRatio) separates targets into three sets: training, validation, and testing. It takes the following inputs,

Q	Number of targets to divide up.
trainRatio	Ratio of vectors for training. Default = 0.7.
valRatio	Ratio of vectors for validation. Default = 0.15.
testRatio	Ratio of vectors for testing. Default = 0.15.

and returns

trainInd	Training indices
valInd	Validation indices
testInd	Test indices

## Examples

```
[trainInd, valInd, testInd] = dividerand(3000, 0.6, 0.2, 0.2);
```

## Network Use

Here are the network properties that define which data division function to use, what its parameters are, and what aspects of targets are divided up, when `train` is called.

```
net.divideFcn
net.divideParam
net.divideMode
```

## See Also

[divideblock](#) | [divideind](#) | [divideint](#) | [dividetrain](#)

**Introduced in R2008a**

## dividetrain

Assign all targets to training set

### Syntax

```
[trainInd,valInd,testInd] = dividetrain(Q)
```

### Description

[trainInd,valInd,testInd] = dividetrain(Q) assigns all targets to the training set and no targets to the validation or test sets. It takes the following inputs:

Q	Number of targets to divide up.
---	---------------------------------

and returns

trainInd	Training indices equal to 1:Q
valInd	Empty validation indices, []
testInd	Empty test indices, []

### Examples

```
[trainInd,valInd,testInd] = dividetrain(250);
```

### Network Use

Here are the network properties that define which data division function to use, what its parameters are, and what aspects of targets are divided up, when `train` is called.

```
net.divideFcn  
net.divideParam  
net.divideMode
```

### See Also

`divideblock` | `divideind` | `divideint` | `dividerand`

**Introduced in R2010b**

# dotprod

Dot product weight function

## Syntax

```
Z = dotprod(W,P,FP)
dim = dotprod('size',S,R,FP)
dw = dotprod('dw',W,P,Z,FP)
info = dotprod('code')
```

## Description

Weight functions apply weights to an input to get weighted inputs.

`Z = dotprod(W,P,FP)` takes these inputs,

W	S-by-R weight matrix
P	R-by-Q matrix of Q input (column) vectors
FP	Struct of function parameters (optional, ignored)

and returns the S-by-Q dot product of W and P.

`dim = dotprod('size',S,R,FP)` takes the layer dimension S, input dimension R, and function parameters, and returns the weight size [S-by-R].

`dw = dotprod('dw',W,P,Z,FP)` returns the derivative of Z with respect to W.

`info = dotprod('code')` returns information about this function. The following codes are defined:

'deriv'	Name of derivative function
'pfullderiv'	Input: reduced derivative = 2, full derivative = 1, linear derivative = 0
'wfullderiv'	Weight: reduced derivative = 2, full derivative = 1, linear derivative = 0
'name'	Full name
'fpnames'	Returns names of function parameters
'fpdefaults'	Returns default function parameters

## Examples

Here you define a random weight matrix W and input vector P and calculate the corresponding weighted input Z.

```
W = rand(4,3);
P = rand(3,1);
Z = dotprod(W,P)
```

## **Network Use**

You can create a standard network that uses `dotprod` by calling `feedforwardnet`.

To change a network so an input weight uses `dotprod`, set `net.inputWeights{i,j}.weightFcn` to `'dotprod'`. For a layer weight, set `net.layerWeights{i,j}.weightFcn` to `'dotprod'`.

In either case, call `sim` to simulate the network with `dotprod`.

## **See Also**

`dist` | `feedforwardnet` | `negdist` | `normprod` | `sim`

**Introduced before R2006a**

# elliotsig

Elliot symmetric sigmoid transfer function

## Syntax

```
A = elliotsig(N)
```

## Description

Transfer functions convert a neural network layer's net input into its net output.

`A = elliotsig(N)` takes an  $S$ -by- $Q$  matrix of  $S$   $N$ -element net input column vectors and returns an  $S$ -by- $Q$  matrix  $A$  of output vectors, where each element of  $N$  is squashed from the interval  $[-\infty \infty]$  to the interval  $[-1 \ 1]$  with an "S-shaped" function.

The advantage of this transfer function over other sigmoids is that it is fast to calculate on simple computing hardware as it does not require any exponential or trigonometric functions. Its disadvantage is that it only flattens out for large inputs, so its effect is not as local as other sigmoid functions. This might result in more training iterations, or require more neurons to achieve the same accuracy.

## Examples

Calculate a layer output from a single net input vector:

```
n = [0; 1; -0.5; 0.5];  
a = elliotsig(n);
```

Plot the transfer function:

```
n = -5:0.01:5;  
plot(n, elliotsig(n))  
set(gca, 'dataaspectratio', [1 1 1], 'xgrid', 'on', 'ygrid', 'on')
```

For a network you have already defined, change the transfer function for layer  $i$ :

```
net.layers{i}.transferFcn = 'elliotsig';
```

## See Also

[elliotsig](#) | [logsig](#) | [tansig](#)

**Introduced in R2012b**

## elliott2sig

Elliot 2 symmetric sigmoid transfer function

### Syntax

```
A = elliott2sig(N)
```

### Description

Transfer functions convert a neural network layer's net input into its net output. This function is a variation on the original Elliot sigmoid function. It has a steeper slope, closer to `tansig`, but is not as smooth at the center.

`A = elliott2sig(N)` takes an  $S$ -by- $Q$  matrix of  $S$   $N$ -element net input column vectors and returns an  $S$ -by- $Q$  matrix  $A$  of output vectors, where each element of  $N$  is squashed from the interval  $[-\infty \infty]$  to the interval  $[-1 \ 1]$  with an "S-shaped" function.

The advantage of this transfer function over other sigmoids is that it is fast to calculate on simple computing hardware as it does not require any exponential or trigonometric functions. Its disadvantage is that it departs from the classic sigmoid shape around zero.

### Examples

Calculate a layer output from a single net input vector:

```
n = [0; 1; -0.5; 0.5];  
a = elliott2sig(n);
```

Plot the transfer function:

```
n = -5:0.01:5;  
plot(n, elliott2sig(n))  
set(gca, 'dataaspectratio', [1 1 1], 'xgrid', 'on', 'ygrid', 'on')
```

For a network you have already defined, change the transfer function for layer  $i$ :

```
net.layers{i}.transferFcn = 'elliott2sig';
```

### See Also

`elliotsig` | `logsig` | `tansig`

**Introduced in R2012b**



# elmannet

Elman neural network

## Syntax

`elmannet(layerdelays,hiddenSizes,trainFcn)`

## Description

Elman networks are feedforward networks (`feedforwardnet`) with the addition of layer recurrent connections with tap delays.

With the availability of full dynamic derivative calculations (`fpderiv` and `bttderiv`), the Elman network is no longer recommended except for historical and research purposes. For more accurate learning try time delay (`timedelaynet`), layer recurrent (`layrecnet`), NARX (`narxnet`), and NAR (`narnet`) neural networks.

Elman networks with one or more hidden layers can learn any dynamic input-output relationship arbitrarily well, given enough neurons in the hidden layers. However, Elman networks use simplified derivative calculations (using `staticderiv`, which ignores delayed connections) at the expense of less reliable learning.

`elmannet(layerdelays,hiddenSizes,trainFcn)` takes these arguments,

<code>layerdelays</code>	Row vector of increasing 0 or positive delays (default = 1:2)
<code>hiddenSizes</code>	Row vector of one or more hidden layer sizes (default = 10)
<code>trainFcn</code>	Training function (default = 'trainlm')

and returns an Elman neural network.

## Examples

Here an Elman neural network is used to solve a simple time series problem.

```
[X,T] = simpleseries_dataset;
net = elmannet(1:2,10);
[Xs,Xi,Ai,Ts] = preparets(net,X,T);
net = train(net,Xs,Ts,Xi,Ai);
view(net)
Y = net(Xs,Xi,Ai);
perf = perform(net,Ts,Y)
```

## See Also

`layrecnet` | `narnet` | `narxnet` | `preparets` | `removedelay` | `timedelaynet`

**Introduced in R2010b**

## errsurf

Error surface of single-input neuron

### Syntax

```
errsurf(P,T,WV,BV,F)
```

### Description

errsurf(P,T,WV,BV,F) takes these arguments,

P	1-by-Q matrix of input vectors
T	1-by-Q matrix of target vectors
WV	Row vector of values of W
BV	Row vector of values of B
F	Transfer function (string)

and returns a matrix of error values over WV and BV.

### Examples

```
p = [-6.0 -6.1 -4.1 -4.0 +4.0 +4.1 +6.0 +6.1];  
t = [+0.0 +0.0 +.97 +.99 +.01 +.03 +1.0 +1.0];  
wv = -1:.1:1; bv = -2.5:.25:2.5;  
es = errsurf(p,t,wv,bv,'logsig');  
plotes(wv,bv,es,[60 30])
```

### See Also

plotes

**Introduced before R2006a**

## extends

Extend time series data to given number of timesteps

### Syntax

```
extends(x, ts, v)
```

### Description

`extends(x, ts, v)` takes these values,

x	Neural network time series data
ts	Number of timesteps
v	Value

and returns the time series data either extended or truncated to match the specified number of timesteps. If the value `v` is specified, then extended series are filled in with that value, otherwise they are extended with random values.

### Examples

Here, a 20-timestep series is created and then extended to 25 timesteps with the value zero.

```
x = nndata(5, 4, 20);  
y = extends(x, 25, 0)
```

### See Also

`catsamples` | `nndata` | `preparets`

**Introduced in R2010b**

## feedforwardnet

Feedforward neural network

### Syntax

```
feedforwardnet(hiddenSizes,trainFcn)
```

### Description

Feedforward networks consist of a series of layers. The first layer has a connection from the network input. Each subsequent layer has a connection from the previous layer. The final layer produces the network's output.

Feedforward networks can be used for any kind of input to output mapping. A feedforward network with one hidden layer and enough neurons in the hidden layers, can fit any finite input-output mapping problem.

Specialized versions of the feedforward network include fitting (`fitnet`) and pattern recognition (`patternnet`) networks. A variation on the feedforward network is the cascade forward network (`cascadeforwardnet`) which has additional connections from the input to every layer, and from each layer to all following layers.

`feedforwardnet(hiddenSizes,trainFcn)` takes these arguments,

<code>hiddenSizes</code>	Row vector of one or more hidden layer sizes (default = 10)
<code>trainFcn</code>	Training function (default = 'trainlm')

and returns a feedforward neural network.

### Examples

#### Feedforward Neural Network

This example shows how to use feedforward neural network to solve a simple problem.

```
[x,t] = simplefit_dataset;  
net = feedforwardnet(10);  
net = train(net,x,t);  
view(net)  
y = net(x);  
perf = perform(net,y,t)
```

```
perf =  
  
1.4639e-04
```

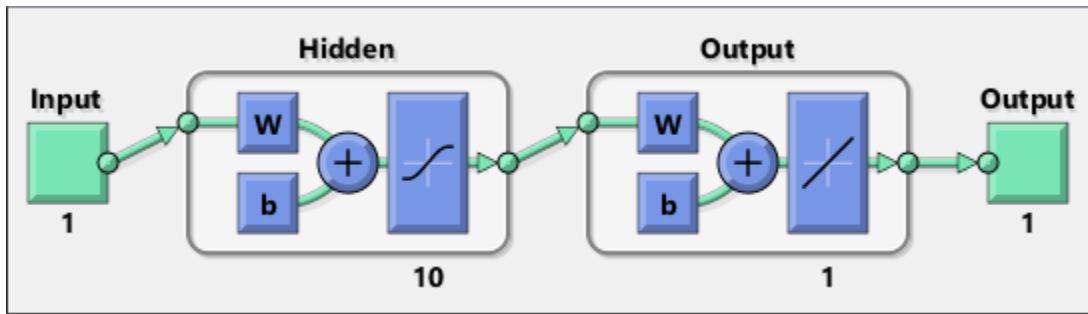

## See Also

[cascadeforwardnet](#) | [fitnet](#) | [network](#) | [patternnet](#)

## Topics

"Neural Network Object Properties"

"Neural Network Subobject Properties"

**Introduced in R2010b**

## fixunknowns

Process data by marking rows with unknown values

### Syntax

```
[y,ps] = fixunknowns(X)
[y,ps] = fixunknowns(X,FP)
Y = fixunknowns('apply',X,PS)
X = fixunknowns('reverse',Y,PS)
name = fixunknowns('name')
fp = fixunknowns('pdefaults')
pd = fixunknowns('pdesc')
fixunknowns('pcheck',fp)
```

### Description

`fixunknowns` processes matrices by replacing each row containing unknown values (represented by NaN) with two rows of information.

The first row contains the original row, with NaN values replaced by the row's mean. The second row contains 1 and 0 values, indicating which values in the first row were known or unknown, respectively.

`[y,ps] = fixunknowns(X)` takes these inputs,

X	N-by-Q matrix
---	---------------

and returns

Y	M-by-Q matrix with M - N rows added
PS	Process settings that allow consistent processing of values

`[y,ps] = fixunknowns(X,FP)` takes an empty struct `FP` of parameters.

`Y = fixunknowns('apply',X,PS)` returns `Y`, given `X` and settings `PS`.

`X = fixunknowns('reverse',Y,PS)` returns `X`, given `Y` and settings `PS`.

`name = fixunknowns('name')` returns the name of this process method.

`fp = fixunknowns('pdefaults')` returns the default process parameter structure.

`pd = fixunknowns('pdesc')` returns the process parameter descriptions.

`fixunknowns('pcheck',fp)` throws an error if any parameter is illegal.

### Examples

Here is how to format a matrix with a mixture of known and unknown values in its second row:

```
x1 = [1 2 3 4; 4 NaN 6 5; NaN 2 3 NaN]
[y1,ps] = fixunknowns(x1)
```

Next, apply the same processing settings to new values:

```
x2 = [4 5 3 2; NaN 9 NaN 2; 4 9 5 2]
y2 = fixunknowns('apply',x2,ps)
```

Reverse the processing of `y1` to get `x1` again.

```
x1_again = fixunknowns('reverse',y1,ps)
```

## More About

### Recode Data with NaNs Using `fixunknowns`

If you have input data with unknown values, you can represent them with `NaN` values. For example, here are five 2-element vectors with unknown values in the first element of two of the vectors:

```
p1 = [1 NaN 3 2 NaN; 3 1 -1 2 4];
```

The network will not be able to process the `NaN` values properly. Use the function `fixunknowns` to transform each row with `NaN` values (in this case only the first row) into two rows that encode that same information numerically.

```
[p2,ps] = fixunknowns(p1);
```

Here is how the first row of values was recoded as two rows.

```
p2 =
     1     2     3     2     2
     1     0     1     1     0
     3     1    -1     2     4
```

The first new row is the original first row, but with the mean value for that row (in this case 2) replacing all `NaN` values. The elements of the second new row are now either 1, indicating the original element was a known value, or 0 indicating that it was unknown. The original second row is now the new third row. In this way both known and unknown values are encoded numerically in a way that lets the network be trained and simulated.

Whenever supplying new data to the network, you should transform the inputs in the same way, using the settings `ps` returned by `fixunknowns` when it was used to transform the training input data.

```
p2new = fixunknowns('apply',p1new,ps);
```

The function `fixunknowns` is only recommended for input processing. Unknown targets represented by `NaN` values can be handled directly by the toolbox learning algorithms. For instance, performance functions used by backpropagation algorithms recognize `NaN` values as unknown or unimportant values.

## See Also

`mapminmax` | `mapstd` | `processpca`

**Introduced in R2006a**

## **formwb**

Form bias and weights into single vector

### **Syntax**

```
formwb(net, b, IW, LW)
```

### **Description**

`formwb(net, b, IW, LW)` takes a neural network and bias `b`, input weight `IW`, and layer weight `LW` values, and combines the values into a single vector.

### **Examples**

Here a network is created, configured, and its weights and biases formed into a vector.

```
[x,t] = simplefit_dataset;  
net = feedforwardnet(10);  
net = configure(net,x,t);  
wb = formwb(net,net.b,net.IW,net.LW)
```

### **See Also**

`getwb` | `separatewb` | `setwb`

**Introduced in R2010b**



## fpderiv

Forward propagation derivative function

### Syntax

```
fpderiv('dperf_dwb',net,X,T,Xi,Ai,EW)
fpderiv('de_dwb',net,X,T,Xi,Ai,EW)
```

### Description

This function calculates derivatives using the chain rule from inputs to outputs, and in the case of dynamic networks, forward through time.

`fpderiv('dperf_dwb',net,X,T,Xi,Ai,EW)` takes these arguments,

<code>net</code>	Neural network
<code>X</code>	Inputs, an R-by-Q matrix (or N-by-TS cell array of Ri-by-Q matrices)
<code>T</code>	Targets, an S-by-Q matrix (or M-by-TS cell array of Si-by-Q matrices)
<code>Xi</code>	Initial input delay states (optional)
<code>Ai</code>	Initial layer delay states (optional)
<code>EW</code>	Error weights (optional)

and returns the gradient of performance with respect to the network's weights and biases, where R and S are the number of input and output elements and Q is the number of samples (or N and M are the number of input and output signals, Ri and Si are the number of each input and outputs elements, and TS is the number of timesteps).

`fpderiv('de_dwb',net,X,T,Xi,Ai,EW)` returns the Jacobian of errors with respect to the network's weights and biases.

### Examples

Here a feedforward network is trained and both the gradient and Jacobian are calculated.

```
[x,t] = simplefit_dataset;
net = feedforwardnet(20);
net = train(net,x,t);
y = net(x);
perf = perform(net,t,y);
gwb = fpderiv('dperf_dwb',net,x,t)
jwb = fpderiv('de_dwb',net,x,t)
```

### See Also

[bttderiv](#) | [defaultderiv](#) | [num2deriv](#) | [num5deriv](#) | [staticderiv](#)

**Introduced in R2010b**

## fromnndata

Convert data from standard neural network cell array form

### Syntax

```
fromnndata(x,toMatrix,columnSample,cellTime)
```

### Description

`fromnndata(x,toMatrix,columnSample,cellTime)` takes these arguments,

<code>net</code>	Neural network
<code>toMatrix</code>	True if result is to be in matrix form
<code>columnSample</code>	True if samples are to be represented as columns, false if rows
<code>cellTime</code>	True if time series are to be represented as a cell array, false if represented with a matrix

and returns the original data reformatted accordingly.

### Examples

Here time-series data is converted from a matrix representation to standard cell array representation, and back. The original data consists of a 5-by-6 matrix representing one time-series sample consisting of a 5-element vector over 6 timesteps arranged in a matrix with the samples as columns.

```
x = rands(5,6)
columnSamples = true; % samples are by columns.
cellTime = false; % time-steps in matrix, not cell array.
[y,wasMatrix] = tonndata(x,columnSamples,cellTime)
x2 = fromnndata(y,wasMatrix,columnSamples,cellTime)
```

Here data is defined in standard neural network data cell form. Converting this data does not change it. The data consists of three time series samples of 2-element signals over 3 timesteps.

```
x = {rands(2,3);rands(2,3);rands(2,3)}
columnSamples = true;
cellTime = true;
[y,wasMatrix] = tonndata(x)
x2 = fromnndata(y,wasMatrix,columnSamples)
```

### See Also

`tonndata`

**Introduced in R2010b**

# gadd

Generalized addition

## Syntax

`gadd(a,b)`

## Description

`gadd(a,b)` takes two matrices or cell arrays, and adds them in an element-wise manner.

## Examples

### Add Matrix and Cell Array Values

This example shows how to add matrix and cell array values.

```
gadd([1 2 3; 4 5 6],[10;20])
```

```
ans = 2×3
```

```
    11    12    13
    24    25    26
```

```
gadd({1 2; 3 4},{1 3; 5 2})
```

```
ans=2×2 cell array
```

```
    {[2]}    {[5]}
    {[8]}    {[6]}
```

```
gadd({1 2 3 4},{10;20;30})
```

```
ans=3×4 cell array
```

```
    {[11]}    {[12]}    {[13]}    {[14]}
    {[21]}    {[22]}    {[23]}    {[24]}
    {[31]}    {[32]}    {[33]}    {[34]}
```

## See Also

`gdivide` | `gmultiply` | `gnegate` | `gsqrt` | `gsubtract`

**Introduced in R2010b**

## gdivide

Generalized division

### Syntax

```
gdivide(a,b)
```

### Description

`gdivide(a,b)` takes two matrices or cell arrays, and divides them in an element-wise manner.

### Examples

#### Divide Matrix and Cell Array Values

This example shows how to divide matrix and cell array values.

```
gdivide([1 2 3; 4 5 6],[10;20])
```

```
ans = 2×3
```

```
    0.1000    0.2000    0.3000  
    0.2000    0.2500    0.3000
```

```
gdivide({1 2; 3 4},{1 3; 5 2})
```

```
ans=2×2 cell array
```

```
    {[    1]}    {[0.6667]}  
    {[0.6000]}    {[    2]}
```

```
gdivide({1 2 3 4},{10;20;30})
```

```
ans=3×4 cell array
```

```
    {[0.1000]}    {[0.2000]}    {[0.3000]}    {[0.4000]}  
    {[0.0500]}    {[0.1000]}    {[0.1500]}    {[0.2000]}  
    {[0.0333]}    {[0.0667]}    {[0.1000]}    {[0.1333]}
```

### See Also

`gadd` | `gmultiply` | `gnegate` | `gsqrt` | `gsubtract`

**Introduced in R2010b**

## gensim

Generate Simulink block for shallow neural network simulation

### Syntax

```
gensim(net,st)
```

### To Get Help

Type `help network/gensim`.

### Description

This function generates a Simulink® block for a shallow neural network. `gensim` does not support deep learning networks such as convolutional or LSTM networks. For more information on code generation for deep learning, see “Deep Learning Code Generation”.

`gensim(net,st)` creates a Simulink system containing a block that simulates neural network `net`.

`gensim(net,st)` takes these inputs:

<code>net</code>	Neural network
<code>st</code>	Sample time (default = 1)

and creates a Simulink system containing a block that simulates neural network `net` with a sampling time of `st`.

If `net` has no input or layer delays (`net.numInputDelays` and `net.numLayerDelays` are both 0), you can use `-1` for `st` to get a network that samples continuously.

### Examples

```
[x,t] = simplefit_dataset;
net = feedforwardnet(10);
net = train(net,x,t)
gensim(net)
```

**Introduced before R2006a**

## genFunction

Generate MATLAB function for simulating shallow neural network

### Syntax

```
genFunction(net,pathname)
genFunction( ____, 'MatrixOnly', 'yes' )
genFunction( ____, 'ShowLinks', 'no' )
```

### Description

This function generates a MATLAB function for simulating a shallow neural network. `genFunction` does not support deep learning networks such as convolutional or LSTM networks. For more information on code generation for deep learning, see “Deep Learning Code Generation”.

`genFunction(net,pathname)` generates a complete stand-alone MATLAB function for simulating a neural network including all settings, weight and bias values, module functions, and calculations in one file. The result is a standalone MATLAB function file. You can also use this function with MATLAB Compiler and MATLAB Coder™ tools.

`genFunction( ____, 'MatrixOnly', 'yes' )` overrides the default cell/matrix notation and instead generates a function that uses only matrix arguments compatible with MATLAB Coder tools. For static networks, the matrix columns are interpreted as independent samples. For dynamic networks, the matrix columns are interpreted as a series of time steps. The default value is 'no'.

`genFunction( ____, 'ShowLinks', 'no' )` disables the default behavior of displaying links to generated help and source code. The default is 'yes'.

### Examples

#### Create Functions from Static Neural Network

This example shows how to create a MATLAB function and a MEX-function from a static neural network.

First, train a static network and calculate its outputs for the training data.

```
[x,t] = bodyfat_dataset;
bodyfatNet = feedforwardnet(10);
bodyfatNet = train(bodyfatNet,x,t);
y = bodyfatNet(x);
```

Next, generate and test a MATLAB function. Then the new function is compiled to a shared/dynamically linked library with `mcc`.

```
genFunction(bodyfatNet, 'bodyfatFcn');
y2 = bodyfatFcn(x);
accuracy2 = max(abs(y-y2))
mcc -W lib:libBodyfat -T link:lib bodyfatFcn
```

Next, generate another version of the MATLAB function that supports only matrix arguments (no cell arrays), and test the function. Use the MATLAB Coder tool `codegen` to generate a MEX-function, which is also tested.

```
genFunction(bodyfatNet, 'bodyfatFcn', 'MatrixOnly', 'yes');
y3 = bodyfatFcn(x);
accuracy3 = max(abs(y-y3))

x1Type = coder.typeof(double(0), [13 Inf]); % Coder type of input 1
codegen bodyfatFcn.m -config:mex -o bodyfatCodeGen -args {x1Type}
y4 = bodyfatodeGen(x);
accuracy4 = max(abs(y-y4))
```

## Create Functions from Dynamic Neural Network

This example shows how to create a MATLAB function and a MEX-function from a dynamic neural network.

First, train a dynamic network and calculate its outputs for the training data.

```
[x,t] = maglev_dataset;
maglevNet = narxnet(1:2,1:2,10);
[X,Xi,Ai,T] = preparets(maglevNet,x,{},t);
maglevNet = train(maglevNet,X,T,Xi,Ai);
[y,xf,af] = maglevNet(X,Xi,Ai);
```

Next, generate and test a MATLAB function. Use the function to create a shared/dynamically linked library with `mcc`.

```
genFunction(maglevNet, 'maglevFcn');
[y2,xf,af] = maglevFcn(X,Xi,Ai);
accuracy2 = max(abs(cell2mat(y)-cell2mat(y2)))
mcc -W lib:libMaglev -T link:lib maglevFcn
```

Next, generate another version of the MATLAB function that supports only matrix arguments (no cell arrays), and test the function. Use the MATLAB Coder tool `codegen` to generate a MEX-function, which is also tested.

```
genFunction(maglevNet, 'maglevFcn', 'MatrixOnly', 'yes');
x1 = cell2mat(X(1,:)); % Convert each input to matrix
x2 = cell2mat(X(2,:));
xi1 = cell2mat(Xi(1,:)); % Convert each input state to matrix
xi2 = cell2mat(Xi(2,:));
[y3,xf1,xf2] = maglevFcn(x1,x2,xi1,xi2);
accuracy3 = max(abs(cell2mat(y)-y3))

x1Type = coder.typeof(double(0), [1 Inf]); % Coder type of input 1
x2Type = coder.typeof(double(0), [1 Inf]); % Coder type of input 2
xi1Type = coder.typeof(double(0), [1 2]); % Coder type of input 1 states
xi2Type = coder.typeof(double(0), [1 2]); % Coder type of input 2 states
codegen maglevFcn.m -config:mex -o maglevNetCodeGen -args {x1Type x2Type xi1Type xi2Type}
[y4,xf1,xf2] = maglevNetCodeGen(x1,x2,xi1,xi2);
dynamic_codegen_accuracy = max(abs(cell2mat(y)-y4))
```

## Input Arguments

### net — neural network

network object

Neural network, specified as a network object.

Example: `net = feedforwardnet(10);`

### **pathname — location and name of generated function file**

(default) | character string

Location and name of generated function file, specified as a character string. If you do not specify a file name extension of `.m`, it is automatically appended. If you do not specify a path to the file, the default location is the current working folder.

Example: `'myFcn.m'`

Data Types: `char`

## **Extended Capabilities**

### **C/C++ Code Generation**

Generate C and C++ code using MATLAB® Coder™.

Usage notes and limitations:

- You can use `genFunction` in the Deep Learning Toolbox to generate a standalone MATLAB function for a trained neural network. You can generate C/C++ code from this standalone MATLAB function. To generate Simulink blocks, use the `genSim` function. See “Deploy Shallow Neural Network Functions”.

### **See Also**

`gensim`

### **Topics**

“Deploy Shallow Neural Network Functions”

**Introduced in R2013b**



# getelements

Get neural network data elements

## Syntax

```
getelements(x,ind)
```

## Description

`getelements(x,ind)` returns the elements of neural network data `x` indicated by the indices `ind`. The neural network data may be in matrix or cell array form.

If `x` is a matrix, the result is the `ind` rows of `x`.

If `x` is a cell array, the result is a cell array with as many columns as `x`, whose elements `(1,i)` are matrices containing the `ind` rows of `[x{: ,i}]`.

## Examples

This code gets elements 1 and 3 from matrix data:

```
x = [1 2 3; 4 7 4]
y = getelements(x,[1 3])
```

This code gets elements 1 and 3 from cell array data:

```
x = {[1:3; 4:6] [7:9; 10:12]; [13:15] [16:18]}
y = getelements(x,[1 3])
```

## See Also

[catelements](#) | [getsamples](#) | [getsignals](#) | [gettimesteps](#) | [nndata](#) | [numelements](#) | [setelements](#)

**Introduced in R2010b**

## getsamples

Get neural network data samples

### Syntax

```
getsamples(x,ind)
```

### Description

`getsamples(x,ind)` returns the samples of neural network data `x` indicated by the indices `ind`. The neural network data may be in matrix or cell array form.

If `x` is a matrix, the result is the `ind` columns of `x`.

If `x` is a cell array, the result is a cell array the same size as `x`, whose elements are the `ind` columns of the matrices in `x`.

### Examples

This code gets samples 1 and 3 from matrix data:

```
x = [1 2 3; 4 7 4]
y = getsamples(x,[1 3])
```

This code gets elements 1 and 3 from cell array data:

```
x = {[1:3; 4:6] [7:9; 10:12]; [13:15] [16:18]}
y = getsamples(x,[1 3])
```

### See Also

[catsamples](#) | [getelements](#) | [getsignals](#) | [gettimesteps](#) | [nndata](#) | [numsamples](#) | [setsamples](#)

**Introduced in R2010b**

# getsignals

Get neural network data signals

## Syntax

```
getsignals(x,ind)
```

## Description

`getsignals(x,ind)` returns the signals of neural network data `x` indicated by the indices `ind`. The neural network data may be in matrix or cell array form.

If `x` is a matrix, `ind` may only be 1, which will return `x`, or `[]` which will return an empty matrix.

If `x` is a cell array, the result is the `ind` rows of `x`.

## Examples

This code gets signal 2 from cell array data:

```
x = {[1:3; 4:6] [7:9; 10:12]; [13:15] [16:18]}  
y = getsignals(x,2)
```

## See Also

[catsignals](#) | [getelements](#) | [getsamples](#) | [gettimesteps](#) | [nndata](#) | [numsignals](#) | [setsignals](#)

**Introduced in R2010b**

## getsiminit

Get Simulink neural network block initial input and layer delays states

### Syntax

```
[xi,ai] = getsiminit(sysName,netName,net)
```

### Description

`[xi,ai] = getsiminit(sysName,netName,net)` takes these arguments,

<code>sysName</code>	The name of the Simulink system containing the neural network block
<code>netName</code>	The name of the Simulink neural network block
<code>net</code>	The original neural network

and returns,

<code>xi</code>	Initial input delay states
<code>ai</code>	Initial layer delay states

### Examples

Here a NARX network is designed. The NARX network has a standard input and an open-loop feedback output to an associated feedback input.

```
[x,t] = simplenarx_dataset;
net = narxnet(1:2,1:2,20);
view(net)
[xs,xi,ai,ts] = preparets(net,x,{},t);
net = train(net,xs,ts,xi,ai);
y = net(xs,xi,ai);
```

Now the network is converted to closed-loop, and the data is reformatted to simulate the network's closed-loop response.

```
net = closeloop(net);
view(net)
[xs,xi,ai,ts] = preparets(net,x,{},t);
y = net(xs,xi,ai);
```

Here the network is converted to a Simulink system with workspace input and output ports. Its delay states are initialized, inputs `X1` defined in the workspace, and it is ready to be simulated in Simulink.

```
[sysName,netName] = gensim(net,'InputMode','Workspace',...
    'OutputMode','Workspace','SolverMode','Discrete');
setsiminit(sysName,netName,net,xi,ai,1);
x1 = nndata2sim(x,1,1);
```

Finally the initial input and layer delays are obtained from the Simulink model. (They will be identical to the values set with `setsiminit`.)

```
[xi,ai] = getsiminit(sysName,netName,net);
```

**See Also**

gensim | nndata2sim | setsiminit | sim2nndata

**Introduced in R2010b**

## gettimesteps

Get neural network data timesteps

### Syntax

```
gettimesteps(x,ind)
```

### Description

`gettimesteps(x,ind)` returns the timesteps of neural network data `x` indicated by the indices `ind`. The neural network data may be in matrix or cell array form.

If `x` is a matrix, `ind` can only be 1, which will return `x`; or `[]`, which will return an empty matrix.

If `x` is a cell array the result is the `ind` columns of `x`.

### Examples

This code gets timestep 2 from cell array data:

```
x = {[1:3; 4:6] [7:9; 10:12]; [13:15] [16:18]}  
y = gettimesteps(x,2)
```

### See Also

`cattimesteps` | `getelements` | `getsamples` | `getsignals` | `nndata` | `numtimesteps` | `settimesteps`

**Introduced in R2010b**

## getwb

Get network weight and bias values as single vector

### Syntax

```
getwb(net)
```

### Description

`getwb(net)` returns a neural network's weight and bias values as a single vector.

### Examples

Here a feedforward network is trained to fit some data, then its bias and weight values are formed into a vector.

```
[x,t] = simplefit_dataset;  
net = feedforwardnet(20);  
net = train(net,x,t);  
wb = getwb(net)
```

### See Also

[formwb](#) | [separatewb](#) | [setwb](#)

**Introduced in R2010b**

## gmultiply

Generalized multiplication

### Syntax

```
gmultiply(a,b)
```

### Description

`gmultiply(a,b)` takes two matrices or cell arrays, and multiplies them in an element-wise manner.

### Examples

#### Multiply Matrix and Cell Array Values

This example shows how to multiply matrix and cell array values.

```
gmultiply([1 2 3; 4 5 6],[10;20])
```

```
ans = 2×3
```

```
    10    20    30  
    80   100   120
```

```
gmultiply({1 2; 3 4},{1 3; 5 2})
```

```
ans=2×2 cell array
```

```
    {[ 1]}    {[6]}  
    {[15]}    {[8]}
```

```
gmultiply({1 2 3 4},{10;20;30})
```

```
ans=3×4 cell array
```

```
    {[10]}    {[20]}    {[30]}    {[ 40]}  
    {[20]}    {[40]}    {[60]}    {[ 80]}  
    {[30]}    {[60]}    {[90]}    {[120]}
```

### See Also

`gadd` | `gdivide` | `gnegate` | `gsqrt` | `gsubtract`

**Introduced in R2010b**



# gnegate

Generalized negation

## Syntax

```
gnegate(x)
```

## Description

gnegate(x) takes a matrix or cell array of matrices, and negates their element values.

## Examples

### Negate a Cell Array

This example shows how to negate a cell array:

```
x = {[1 2; 3 4],[1 -3; -5 2]};  
y = gnegate(x);  
y{1}, y{2}
```

```
ans = 2×2
```

```
    -1    -2  
    -3    -4
```

```
ans = 2×2
```

```
    -1     3  
     5    -2
```

## See Also

gadd | gdivide | gmultiply | gsqrt | gsubtract

**Introduced in R2010b**

## gpu2nndata

Reformat neural data back from GPU

### Syntax

```
X = gpu2nndata(Y,Q)
X = gpu2nndata(Y)
X = gpu2nndata(Y,Q,N,TS)
```

### Description

Training and simulation of neural networks require that matrices be transposed. But they do not require (although they are more efficient with) padding of column length so that each column is memory aligned. This function copies data back from the current GPU and reverses this transform. It can be used on data formatted with `nndata2gpu` or on the results of network simulation.

`X = gpu2nndata(Y,Q)` copies the  $QQ$ -by- $N$  `gpuArray` `Y` into RAM, takes the first  $Q$  rows and transposes the result to get an  $N$ -by- $Q$  matrix representing  $Q$   $N$ -element vectors.

`X = gpu2nndata(Y)` calculates  $Q$  as the index of the last row in `Y` that is not all NaN values (those rows were added to pad `Y` for efficient GPU computation by `nndata2gpu`). `Y` is then transformed as before.

`X = gpu2nndata(Y,Q,N,TS)` takes a  $QQ$ -by- $(N*TS)$  `gpuArray` where `N` is a vector of signal sizes,  $Q$  is the number of samples (less than or equal to the number of rows after alignment padding  $QQ$ ), and `TS` is the number of time steps.

The `gpuArray` `Y` is copied back into RAM, the first  $Q$  rows are taken, and then it is partitioned and transposed into an  $M$ -by-`TS` cell array, where  $M$  is the number of elements in `N`. Each `Y{i,ts}` is an  $N(i)$ -by- $Q$  matrix.

### Examples

Copy a matrix to the GPU and back:

```
x = rand(5,6)
[y,q] = nndata2gpu(x)
x2 = gpu2nndata(y,q)
```

Copy from the GPU a neural network cell array data representing four time series, each consisting of five time steps of 2-element and 3-element signals.

```
x = nndata([2;3],4,5)
[y,q,n,ts] = nndata2gpu(x)
x2 = gpu2nndata(y,q,n,ts)
```

### See Also

`nndata2gpu`

**Introduced in R2012b**

## gridtop

Grid layer topology function

### Syntax

```
gridtop(dimensions)
```

### Description

`pos = gridtop` calculates neuron positions for layers whose neurons are arranged in an N-dimensional grid.

`gridtop(dimensions)` takes one argument:

<code>dimensions</code>	Row vector of dimension sizes
-------------------------	-------------------------------

and returns an N-by-S matrix of N coordinate vectors where N is the number of dimensions and S is the product of dimensions.

### Examples

#### Display Layer with Grid Pattern

This example shows how to display a two-dimensional layer with 40 neurons arranged in an 8-by-5 grid pattern.

```
pos = gridtop([8 5]);  
plotsom(pos)
```

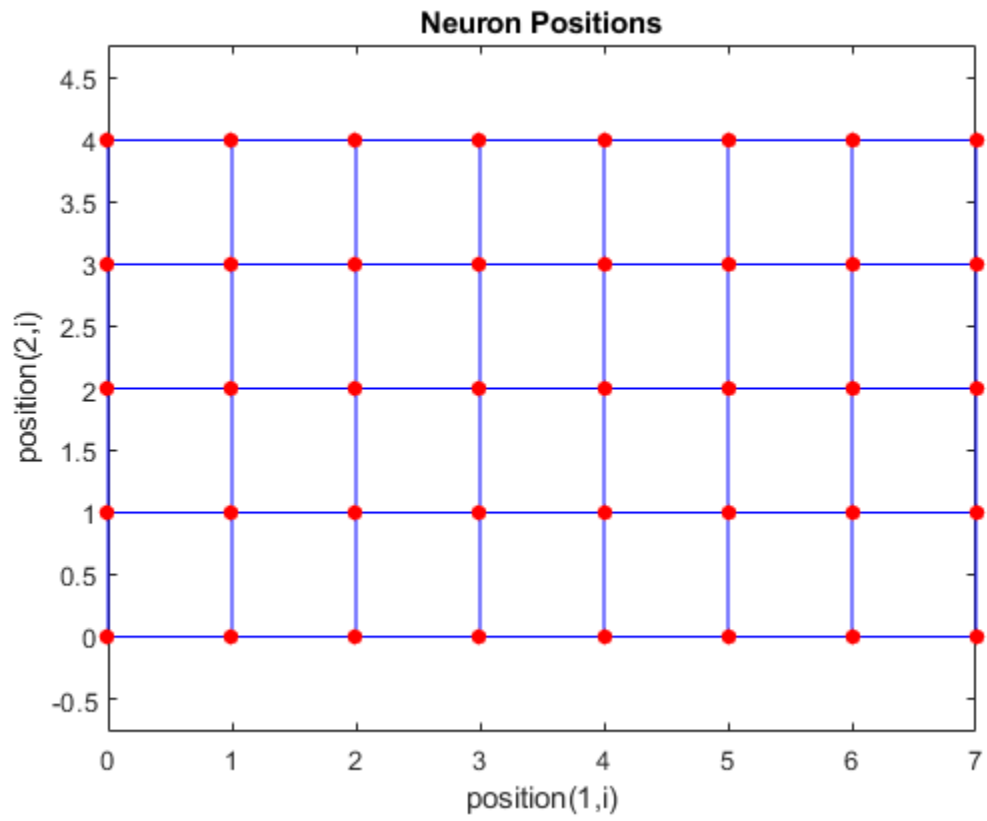
**See Also**

hextop | randtop | tritop

**Introduced before R2006a**

## gsqrt

Generalized square root

### Syntax

```
gsqrt(x)
```

### Description

`gsqrt(x)` takes a matrix or cell array of matrices, and generates the element-wise square root of the matrices.

### Examples

#### Compute Element-Wise Square Root

This example shows how to get the element-wise square root of a cell array:

```
gsqrt({1 2; 3 4})  
  
ans=2x2 cell array  
    {[    1]}    {[1.4142]}  
    {[1.7321]}    {[    2]}
```

### See Also

[gadd](#) | [gdivide](#) | [gmultiply](#) | [gnegate](#) | [gsubtract](#)

**Introduced in R2010b**

# gsubtract

Generalized subtraction

## Syntax

`gsubtract(a,b)`

## Description

`gsubtract(a,b)` takes two matrices or cell arrays, and subtracts them in an element-wise manner.

## Examples

### Subtract Matrix and Cell Array Values

This example shows how to subtract matrix and cell array values.

```
gsubtract([1 2 3; 4 5 6],[10;20])
```

```
ans = 2×3
```

```
    -9    -8    -7
   -16   -15   -14
```

```
gsubtract({1 2; 3 4},{1 3; 5 2})
```

```
ans=2×2 cell array
```

```
    {[ 0]}    {[ -1]}
    {[ -2]}    {[ 2]}
```

```
gsubtract({1 2 3 4},{10;20;30})
```

```
ans=3×4 cell array
```

```
    {[ -9]}    {[ -8]}    {[ -7]}    {[ -6]}
    {[ -19]}    {[ -18]}    {[ -17]}    {[ -16]}
    {[ -29]}    {[ -28]}    {[ -27]}    {[ -26]}
```

## See Also

[gadd](#) | [gdivide](#) | [gmultiply](#) | [gnegate](#) | [gsqrt](#)

**Introduced in R2010b**

## hardlim

Hard-limit transfer function

### Graph and Symbol

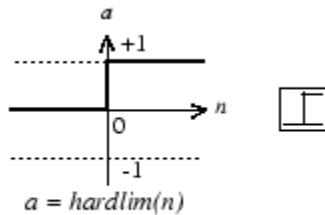

Hard-Limit Transfer Function

### Syntax

$A = \text{hardlim}(N, FP)$

### Description

`hardlim` is a neural transfer function. Transfer functions calculate a layer's output from its net input.

$A = \text{hardlim}(N, FP)$  takes  $N$  and optional function parameters,

$N$	S-by-Q matrix of net input (column) vectors
$FP$	Struct of function parameters (ignored)

and returns  $A$ , the S-by-Q Boolean matrix with 1s where  $N \geq 0$ .

`info = hardlim('code')` returns information according to the code string specified:

`hardlim('name')` returns the name of this function.

`hardlim('output', FP)` returns the [min max] output range.

`hardlim('active', FP)` returns the [min max] active input range.

`hardlim('fullderiv')` returns 1 or 0, depending on whether  $dA_{dN}$  is S-by-S-by-Q or S-by-Q.

`hardlim('fpnames')` returns the names of the function parameters.

`hardlim('fpdefaults')` returns the default function parameters.

### Examples

Here is how to create a plot of the `hardlim` transfer function.

```
n = -5:0.1:5;
a = hardlim(n);
plot(n,a)
```



Assign this transfer function to layer *i* of a network.

```
net.layers{i}.transferFcn = 'hardlim';
```

## Algorithms

$\text{hardlim}(n) = 1$  if  $n \geq 0$   
0 otherwise

## See Also

[hardlims](#) | [sim](#)

**Introduced before R2006a**

## hardlims

Symmetric hard-limit transfer function

### Graph and Symbol

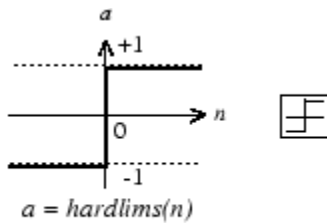

Symmetric Hard-Limit Transfer Function

### Syntax

$A = \text{hardlims}(N, FP)$

### Description

`hardlims` is a neural transfer function. Transfer functions calculate a layer's output from its net input.

$A = \text{hardlims}(N, FP)$  takes  $N$  and optional function parameters,

$N$	S-by-Q matrix of net input (column) vectors
$FP$	Struct of function parameters (ignored)

and returns  $A$ , the S-by-Q +1/-1 matrix with +1s where  $N \geq 0$ .

`info = hardlims('code')` returns information according to the code string specified:

`hardlims('name')` returns the name of this function.

`hardlims('output', FP)` returns the [min max] output range.

`hardlims('active', FP)` returns the [min max] active input range.

`hardlims('fullderiv')` returns 1 or 0, depending on whether  $dA_{dN}$  is S-by-S-by-Q or S-by-Q.

`hardlims('fpnames')` returns the names of the function parameters.

`hardlims('fpdefaults')` returns the default function parameters.

### Examples

Here is how to create a plot of the `hardlims` transfer function.

```
n = -5:0.1:5;  
a = hardlims(n);  
plot(n,a)
```

Assign this transfer function to layer *i* of a network.

```
net.layers{i}.transferFcn = 'hardlims';
```

## Algorithms

$\text{hardlims}(n) = 1$  if  $n \geq 0$ ,  $-1$  otherwise.

## See Also

[hardlim](#) | [sim](#)

**Introduced before R2006a**

## hextop

Hexagonal layer topology function

### Syntax

```
hextop(dimensions)
```

### Description

`hextop` calculates the neuron positions for layers whose neurons are arranged in an N-dimensional hexagonal pattern.

`hextop(dimensions)` takes one argument:

<code>dimensions</code>	Row vector of dimension sizes
-------------------------	-------------------------------

and returns an N-by-S matrix of N coordinate vectors where N is the number of dimensions and S is the product of dimensions.

### Examples

#### Display Layer with Hexagonal Pattern

This example shows how to display a two-dimensional layer with 40 neurons arranged in an 8-by-5 hexagonal pattern.

```
pos = hextop([8 5]);  
plotsom(pos)
```

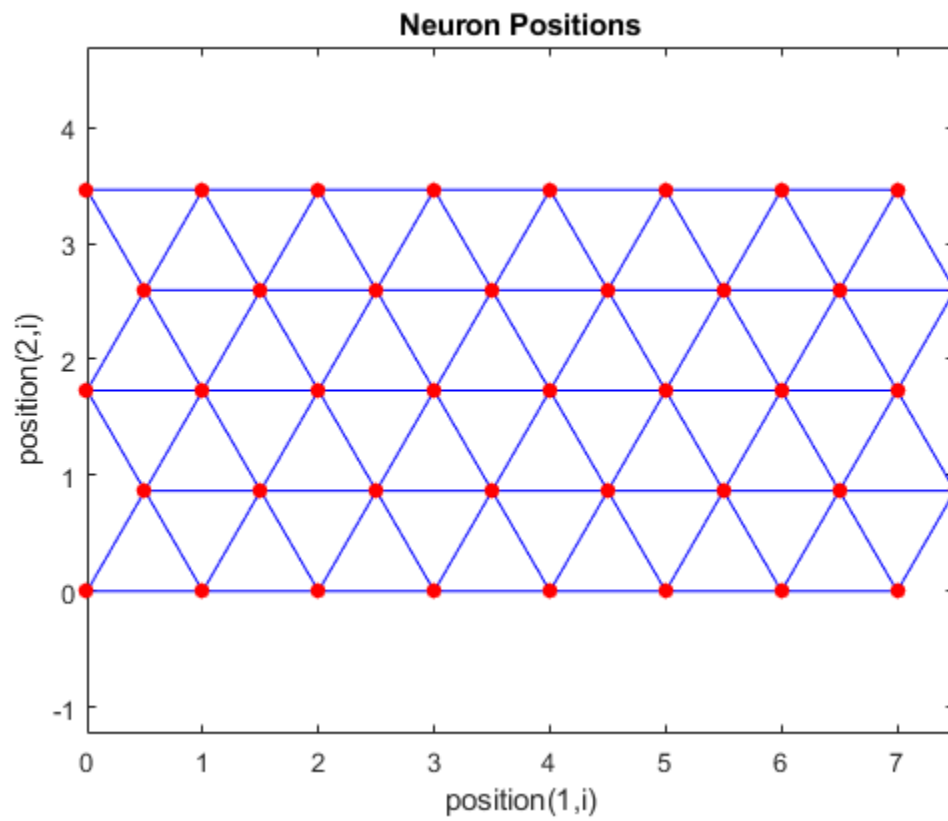

## ind2vec

Convert indices to vectors

### Syntax

```
ind2vec(ind)
ind2vec(ind,N)
```

### Description

`ind2vec` and `vec2ind` allow indices to be represented either by themselves, or as vectors containing a 1 in the row of the index they represent.

`ind2vec(ind)` takes one argument,

<code>ind</code>	Row vector of indices
------------------	-----------------------

and returns a sparse matrix of vectors, with one 1 in each column, as indicated by `ind`.

`ind2vec(ind,N)` returns an N-by-M matrix, where N can be equal to or greater than the maximum index.

### Examples

Here four indices are defined and converted to vector representation.

```
ind = [1 3 2 3];
vec = ind2vec(ind)
```

```
vec =
    (1,1)      1
    (3,2)      1
    (2,3)      1
    (3,4)      1
```

Here a vector with all zeros in the last row is converted to indices and back, while preserving the number of rows.

```
vec = [0 0 1 0; 1 0 0 0; 0 1 0 0]'
```

```
vec =
    0     1     0
    0     0     1
    1     0     0
    0     0     0
```

```
[ind,n] = vec2ind(vec)
```

```
ind =
    3     1     2
```

```
n =
    4
```

```
vec2 = full(ind2vec(ind,n))
```

```
vec2 =  
  0     1     0  
  0     0     1  
  1     0     0  
  0     0     0
```

**See Also**

[ind2sub](#) | [sub2ind](#) | [vec2ind](#)

**Introduced before R2006a**

## init

Initialize neural network

### Syntax

```
net = init(net)
```

### To Get Help

Type `help network/init`.

### Description

`net = init(net)` returns neural network `net` with weight and bias values updated according to the network initialization function, indicated by `net.initFcn`, and the parameter values, indicated by `net.initParam`.

### Examples

Here a perceptron is created, and then configured so that its input, output, weight, and bias dimensions match the input and target data.

```
x = [0 1 0 1; 0 0 1 1];  
t = [0 0 0 1];  
net = perceptron;  
net = configure(net,x,t);  
net.iw{1,1}  
net.b{1}
```

Training the perceptron alters its weight and bias values.

```
net = train(net,x,t);  
net.iw{1,1}  
net.b{1}
```

`init` reinitializes those weight and bias values.

```
net = init(net);  
net.iw{1,1}  
net.b{1}
```

The weights and biases are zeros again, which are the initial values used by perceptron networks.

### Algorithms

`init` calls `net.initFcn` to initialize the weight and bias values according to the parameter values `net.initParam`.

Typically, `net.initFcn` is set to `'initlay'`, which initializes each layer's weights and biases according to its `net.layers{i}.initFcn`.



Backpropagation networks have `net.layers{i}.initFcn` set to `'initnw'`, which calculates the weight and bias values for layer `i` using the Nguyen-Widrow initialization method.

Other networks have `net.layers{i}.initFcn` set to `'initwb'`, which initializes each weight and bias with its own initialization function. The most common weight and bias initialization function is `rands`, which generates random values between -1 and 1.

### **See Also**

`adapt` | `initlay` | `initnw` | `initwb` | `rands` | `revert` | `sim` | `train`

**Introduced before R2006a**

## initcon

Conscience bias initialization function

### Syntax

```
initcon (S,PR)
```

### Description

`initcon` is a bias initialization function that initializes biases for learning with the `learncon` learning function.

`initcon (S,PR)` takes two arguments,

S	Number of rows (neurons)
PR	R-by-2 matrix of $R = [Pmin \ Pmax]$ (default = [1 1])

and returns an S-by-1 bias vector.

Note that for biases, R is always 1. `initcon` could also be used to initialize weights, but it is not recommended for that purpose.

### Examples

Here initial bias values are calculated for a five-neuron layer.

```
b = initcon(5)
```

### Network Use

You can create a standard network that uses `initcon` to initialize weights by calling `competlayer`.

To prepare the bias of layer `i` of a custom network to initialize with `initcon`,

- 1 Set `net.initFcn` to 'initlay'. (`net.initParam` automatically becomes `initlay`'s default parameters.)
- 2 Set `net.layers{i}.initFcn` to 'initwb'.
- 3 Set `net.biases{i}.initFcn` to 'initcon'.

To initialize the network, call `init`.

### Algorithms

`learncon` updates biases so that each bias value  $b(i)$  is a function of the average output  $c(i)$  of the neuron `i` associated with the bias.

`initcon` gets initial bias values by assuming that each neuron has responded to equal numbers of vectors in the past.

**See Also**

competlayer | init | initlay | initwb | learncon

**Introduced before R2006a**

## initlay

Layer-by-layer network initialization function

### Syntax

```
net = initlay(net)
info = initlay('code')
```

### Description

`initlay` is a network initialization function that initializes each layer `i` according to its own initialization function `net.layers{i}.initFcn`.

`net = initlay(net)` takes

<code>net</code>	Neural network
------------------	----------------

and returns the network with each layer updated.

`info = initlay('code')` returns useful information for each supported `code` character vector:

<code>'pnames'</code>	Names of initialization parameters
<code>'pdefaults'</code>	Default initialization parameters

`initlay` does not have any initialization parameters.

### Network Use

You can create a standard network that uses `initlay` by calling `feedforwardnet`, `cascadeforwardnet`, and many other network functions.

To prepare a custom network to be initialized with `initlay`,

- 1 Set `net.initFcn` to `'initlay'`. This sets `net.initParam` to the empty matrix `[]`, because `initlay` has no initialization parameters.
- 2 Set each `net.layers{i}.initFcn` to a layer initialization function. (Examples of such functions are `inittwb` and `initnw`.)

To initialize the network, call `init`.

### Algorithms

The weights and biases of each layer `i` are initialized according to `net.layers{i}.initFcn`.

### See Also

`cascadeforwardnet` | `feedforwardnet` | `init` | `initnw` | `initwb`

**Introduced before R2006a**

## initlvq

LVQ weight initialization function

### Syntax

```
initlvq('configure',x)
initlvq('configure',net,'IW',i,j,settings)
initlvq('configure',net,'LW',i,j,settings)
initlvq('configure',net,'b',i,)
```

### Description

`initlvq('configure',x)` takes input data `x` and returns initialization settings for an LVQ weights associated with that input.

`initlvq('configure',net,'IW',i,j,settings)` takes a network, and indices indicating an input weight to layer `i` from input `j`, and that weights settings, and returns new weight values.

`initlvq('configure',net,'LW',i,j,settings)` takes a network, and indices indicating a layer weight to layer `i` from layer `j`, and that weights settings, and returns new weight values.

`initlvq('configure',net,'b',i,)` takes a network, and an index indicating a bias for layer `i`, and returns new bias values.

### See Also

`initlvqnet`

**Introduced in R2010b**

# initnw

Nguyen-Widrow layer initialization function

## Syntax

```
net = initnw(net,i)
```

## Description

`initnw` is a layer initialization function that initializes a layer's weights and biases according to the Nguyen-Widrow initialization algorithm. This algorithm chooses values in order to distribute the active region of each neuron in the layer approximately evenly across the layer's input space. The values contain a degree of randomness, so they are not the same each time this function is called.

`initnw` requires that the layer it initializes have a transfer function with a finite active input range. This includes transfer functions such as `tansig` and `satlin`, but not `purelin`, whose active input range is the infinite interval  $[-\infty, \infty]$ . Transfer functions, such as `tansig`, will return their active input range as follows:

```
activeInputRange = tansig('active')
activeInputRange =
    -2     2
```

`net = initnw(net,i)` takes two arguments,

<code>net</code>	Neural network
<code>i</code>	Index of a layer

and returns the network with layer `i`'s weights and biases updated.

There is a random element to Nguyen-Widrow initialization. Unless the default random generator is set to the same seed before each call to `initnw`, it will generate different weight and bias values each time.

## Network Use

You can create a standard network that uses `initnw` by calling `feedforwardnet` or `cascadeforwardnet`.

To prepare a custom network to be initialized with `initnw`,

- 1 Set `net.initFcn` to `'initlay'`. This sets `net.initParam` to the empty matrix `[]`, because `initlay` has no initialization parameters.
- 2 Set `net.layers{i}.initFcn` to `'initnw'`.

To initialize the network, call `init`.

### Algorithms

The Nguyen-Widrow method generates initial weight and bias values for a layer so that the active regions of the layer's neurons are distributed approximately evenly over the input space.

Advantages over purely random weights and biases are

- Few neurons are wasted (because all the neurons are in the input space).
- Training works faster (because each area of the input space has neurons). The Nguyen-Widrow method can only be applied to layers
  - With a bias
  - With weights whose `weightFcn` is `dotprod`
  - With `netInputFcn` set to `netsum`
  - With `transferFcn` whose active region is finite

If these conditions are not met, then `initnw` uses `rands` to initialize the layer's weights and biases.

### See Also

`cascadeforwardnet` | `feedforwardnet` | `init` | `initlay` | `initwb`

**Introduced before R2006a**



# initwb

By weight and bias layer initialization function

## Syntax

```
initwb(net,i)
```

## Description

`initwb` is a layer initialization function that initializes a layer's weights and biases according to their own initialization functions.

`initwb(net,i)` takes two arguments,

<code>net</code>	Neural network
<code>i</code>	Index of a layer

and returns the network with layer `i`'s weights and biases updated.

## Network Use

You can create a standard network that uses `initwb` by calling `perceptron` or `linearlayer`.

To prepare a custom network to be initialized with `initwb`,

- 1 Set `net.initFcn` to `'initlay'`. This sets `net.initParam` to the empty matrix `[]`, because `initlay` has no initialization parameters.
- 2 Set `net.layers{i}.initFcn` to `'initwb'`.
- 3 Set each `net.inputWeights{i,j}.initFcn` to a weight initialization function. Set each `net.layerWeights{i,j}.initFcn` to a weight initialization function. Set each `net.biases{i}.initFcn` to a bias initialization function. Examples of initialization functions are `rands` (for weights and biases) and `midpoint` (for weights only).

To initialize the network, call `init`.

## Algorithms

Each weight (bias) in layer `i` is set to new values calculated according to its weight (bias) initialization function.

## See Also

`init` | `initlay` | `initnw` | `linearlayer` | `perceptron`

Introduced before R2006a

## initzero

Zero weight and bias initialization function

### Syntax

```
W = initzero(S,PR)
b = initzero(S,[1 1])
```

### Description

`W = initzero(S,PR)` takes two arguments,

S	Number of rows (neurons)
PR	R-by-2 matrix of input value ranges = [Pmin Pmax]

and returns an S-by-R weight matrix of zeros.

`b = initzero(S,[1 1])` returns an S-by-1 bias vector of zeros.

### Examples

Here initial weights and biases are calculated for a layer with two inputs ranging over [0 1] and [-2 2] and four neurons.

```
W = initzero(5,[0 1; -2 2])
b = initzero(5,[1 1])
```

### See Also

`init` | `initlay` | `initwb`

**Introduced before R2006a**

# isconfigured

Indicate if network inputs and outputs are configured

## Syntax

```
[flag,inputflags,outputflags] = isconfigured(net)
```

## Description

[flag,inputflags,outputflags] = isconfigured(net) takes a neural network and returns three values,

flag	True if all network inputs and outputs are configured (have non-zero sizes)
inputflags	Vector of true/false values for each configured/unconfigured input
outputflags	Vector of true/false values for each configured/unconfigured output

## Examples

Here are the flags returned for a new network before and after being configured:

```
net = feedforwardnet;
[flag,inputFlags,outputFlags] = isconfigured(net)
[x,t] = simplefit_dataset;
net = configure(net,x,t);
[flag,inputFlags,outputFlags] = isconfigured(net)
```

## See Also

configure | unconfigure

**Introduced in R2010b**

# layrecnet

Layer recurrent neural network

## Syntax

```
layrecnet(layerDelays,hiddenSizes,trainFcn)
```

## Description

Layer recurrent neural networks are similar to feedforward networks, except that each layer has a recurrent connection with a tap delay associated with it. This allows the network to have an infinite dynamic response to time series input data. This network is similar to the time delay (`timedelaynet`) and distributed delay (`distdelaynet`) neural networks, which have finite input responses.

`layrecnet(layerDelays,hiddenSizes,trainFcn)` takes these arguments,

<code>layerDelays</code>	Row vector of increasing 0 or positive delays (default = 1:2)
<code>hiddenSizes</code>	Row vector of one or more hidden layer sizes (default = 10)
<code>trainFcn</code>	Training function (default = 'trainlm')

and returns a layer recurrent neural network.

## Examples

### Recurrent Neural Network

Use a layer recurrent neural network to solve a simple time series problem.

```
[X,T] = simpleseries_dataset;  
net = layrecnet(1:2,10);  
[Xs,Xi,Ai,Ts] = preparets(net,X,T);  
net = train(net,Xs,Ts,Xi,Ai);  
view(net)  
Y = net(Xs,Xi,Ai);  
perf = perform(net,Y,Ts)
```

```
perf =
```

```
6.1239e-11
```

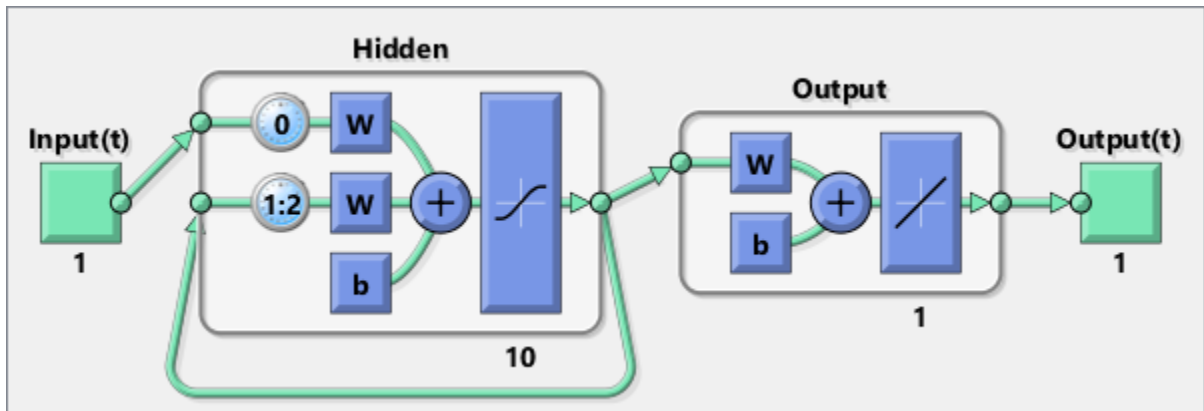

### See Also

[distdelaynet](#) | [narnet](#) | [narxnet](#) | [preparets](#) | [removedelay](#) | [timedelaynet](#)

Introduced in R2010b

# learncon

Conscience bias learning function

## Syntax

```
[dB,LS] = learncon(B,P,Z,N,A,T,E,gW,gA,D,LP,LS)
info = learncon('code')
```

## Description

learncon is the conscience bias learning function used to increase the net input to neurons that have the lowest average output until each neuron responds approximately an equal percentage of the time.

[dB,LS] = learncon(B,P,Z,N,A,T,E,gW,gA,D,LP,LS) takes several inputs,

B	S-by-1 bias vector
P	1-by-Q ones vector
Z	S-by-Q weighted input vectors
N	S-by-Q net input vectors
A	S-by-Q output vectors
T	S-by-Q layer target vectors
E	S-by-Q layer error vectors
gW	S-by-R gradient with respect to performance
gA	S-by-Q output gradient with respect to performance
D	S-by-S neuron distances
LP	Learning parameters, none, LP = []
LS	Learning state, initially should be = []

and returns

dB	S-by-1 weight (or bias) change matrix
LS	New learning state

Learning occurs according to learncon's learning parameter, shown here with its default value.

LP.lr - 0.001	Learning rate
---------------	---------------

info = learncon('code') returns useful information for each supported code character vector:

'pnames'	Names of learning parameters
'pdefaults'	Default learning parameters
'needg'	Returns 1 if this function uses gW or gA

Deep Learning Toolbox 2.0 compatibility: The `LP.Lr` described above equals 1 minus the bias time constant used by `trainc` in the Deep Learning Toolbox 2.0 software.

## Examples

Here you define a random output `A` and bias vector `W` for a layer with three neurons. You also define the learning rate `LR`.

```
a = rand(3,1);
b = rand(3,1);
lp.lr = 0.5;
```

Because `learncon` only needs these values to calculate a bias change (see “Algorithm” below), use them to do so.

```
dW = learncon(b,[],[],[],a,[],[],[],[],[],lp,[])
```

## Network Use

To prepare the bias of layer `i` of a custom network to learn with `learncon`,

- 1 Set `net.trainFcn` to `'trainr'`. (`net.trainParam` automatically becomes `trainr`'s default parameters.)
- 2 Set `net.adaptFcn` to `'trains'`. (`net.adaptParam` automatically becomes `trains`'s default parameters.)
- 3 Set `net.inputWeights{i}.learnFcn` to `'learncon'`
- 4 Set each `net.layerWeights{i,j}.learnFcn` to `'learncon'`. (Each weight learning parameter property is automatically set to `learncon`'s default parameters.)

To train the network (or enable it to adapt),

- 1 Set `net.trainParam` (or `net.adaptParam`) properties as desired.
- 2 Call `train` (or `adapt`).

## Algorithms

`learncon` calculates the bias change `db` for a given neuron by first updating each neuron's *conscience*, i.e., the running average of its output:

$$c = (1-lr)*c + lr*a$$

The conscience is then used to compute a bias for the neuron that is greatest for smaller conscience values.

$$b = \exp(1-\log(c)) - b$$

(`learncon` recovers `C` from the bias values each time it is called.)

## See Also

`adapt` | `learnk` | `learnos` | `train`

**Introduced before R2006a**



# learnngd

Gradient descent weight and bias learning function

## Syntax

```
[dW,LS] = learnngd(W,P,Z,N,A,T,E,gW,gA,D,LP,LS)
info = learnngd('code')
```

## Description

learnngd is the gradient descent weight and bias learning function.

[dW,LS] = learnngd(W,P,Z,N,A,T,E,gW,gA,D,LP,LS) takes several inputs:

W	S-by-R weight matrix (or S-by-1 bias vector)
P	R-by-Q input vectors (or ones (1,Q))
Z	S-by-Q output gradient with respect to performance x Q weighted input vectors
N	S-by-Q net input vectors
A	S-by-Q output vectors
T	S-by-Q layer target vectors
E	S-by-Q layer error vectors
gW	S-by-R gradient with respect to performance
gA	S-by-Q output gradient with respect to performance
D	S-by-S neuron distances
LP	Learning parameters, none, LP = []
LS	Learning state, initially should be []

and returns

dW	S-by-R weight (or bias) change matrix
LS	New learning state

Learning occurs according to learnngd's learning parameter, shown here with its default value.

LP.lr - 0.01	Learning rate
--------------	---------------

info = learnngd('code') returns useful information for each supported *code* character vector:

'pnames'	Names of learning parameters
'pdefaults'	Default learning parameters
'needg'	Returns 1 if this function uses gW or gA

### Examples

Here you define a random gradient  $gW$  for a weight going to a layer with three neurons from an input with two elements. Also define a learning rate of 0.5.

```
gW = rand(3,2);  
lp.lr = 0.5;
```

Because `learngd` only needs these values to calculate a weight change (see “Algorithm” below), use them to do so.

```
dW = learngd([],[],[],[],[],[],[],gW,[],[],lp,[])
```

### Algorithms

`learngd` calculates the weight change  $dW$  for a given neuron from the neuron’s input  $P$  and error  $E$ , and the weight (or bias) learning rate  $LR$ , according to the gradient descent  $dw = lr * gW$ .

### See Also

`adapt` | `learngdm` | `train`

**Introduced before R2006a**

# learnngdm

Gradient descent with momentum weight and bias learning function

## Syntax

```
[dW,LS] = learnngdm(W,P,Z,N,A,T,E,gW,gA,D,LP,LS)
info = learnngdm('code')
```

## Description

learnngdm is the gradient descent with momentum weight and bias learning function.

[dW,LS] = learnngdm(W,P,Z,N,A,T,E,gW,gA,D,LP,LS) takes several inputs,

W	S-by-R weight matrix (or S-by-1 bias vector)
P	R-by-Q input vectors (or ones (1, Q))
Z	S-by-Q weighted input vectors
N	S-by-Q net input vectors
A	S-by-Q output vectors
T	S-by-Q layer target vectors
E	S-by-Q layer error vectors
gW	S-by-R gradient with respect to performance
gA	S-by-Q output gradient with respect to performance
D	S-by-S neuron distances
LP	Learning parameters, none, LP = []
LS	Learning state, initially should be = []

and returns

dW	S-by-R weight (or bias) change matrix
LS	New learning state

Learning occurs according to learnngdm's learning parameters, shown here with their default values.

LP.lr - 0.01	Learning rate
LP.mc - 0.9	Momentum constant

info = learnngdm('code') returns useful information for each code character vector:

'pnames'	Names of learning parameters
'pdefaults'	Default learning parameters
'needg'	Returns 1 if this function uses gW or gA

## Examples

Here you define a random gradient  $G$  for a weight going to a layer with three neurons from an input with two elements. Also define a learning rate of 0.5 and momentum constant of 0.8:

```
gW = rand(3,2);  
lp.lr = 0.5;  
lp.mc = 0.8;
```

Because `learngdm` only needs these values to calculate a weight change (see “Algorithm” below), use them to do so. Use the default initial learning state.

```
ls = [];  
[dW,ls] = learngdm([],[],[],[],[],[],[],gW,[],[],lp,ls)
```

`learngdm` returns the weight change and a new learning state.

## Algorithms

`learngdm` calculates the weight change  $dW$  for a given neuron from the neuron’s input  $P$  and error  $E$ , the weight (or bias)  $W$ , learning rate  $LR$ , and momentum constant  $MC$ , according to gradient descent with momentum:

$$dW = mc*dW_{prev} + (1-mc)*lr*gW$$

The previous weight change  $dW_{prev}$  is stored and read from the learning state  $LS$ .

## See Also

`adapt` | `learngd` | `train`

**Introduced before R2006a**

# learnh

Hebb weight learning rule

## Syntax

```
[dW,LS] = learnh(W,P,Z,N,A,T,E,gW,gA,D,LP,LS)
info = learnh('code')
```

## Description

learnh is the Hebb weight learning function.

[dW,LS] = learnh(W,P,Z,N,A,T,E,gW,gA,D,LP,LS) takes several inputs,

W	S-by-R weight matrix (or S-by-1 bias vector)
P	R-by-Q input vectors (or ones(1,Q))
Z	S-by-Q weighted input vectors
N	S-by-Q net input vectors
A	S-by-Q output vectors
T	S-by-Q layer target vectors
E	S-by-Q layer error vectors
gW	S-by-R gradient with respect to performance
gA	S-by-Q output gradient with respect to performance
D	S-by-S neuron distances
LP	Learning parameters, none, LP = []
LS	Learning state, initially should be = []

and returns

dW	S-by-R weight (or bias) change matrix
LS	New learning state

Learning occurs according to learnh's learning parameter, shown here with its default value.

LP.lr - 0.01	Learning rate
--------------	---------------

info = learnh('code') returns useful information for each code character vector:

'pnames'	Names of learning parameters
'pdefaults'	Default learning parameters
'needg'	Returns 1 if this function uses gW or gA

### Examples

Here you define a random input  $P$  and output  $A$  for a layer with a two-element input and three neurons. Also define the learning rate  $LR$ .

```
p = rand(2,1);  
a = rand(3,1);  
lp.lr = 0.5;
```

Because `learnh` only needs these values to calculate a weight change (see “Algorithm” below), use them to do so.

```
dW = learnh([],p,[],[],a,[],[],[],[],[],lp,[])
```

### Network Use

To prepare the weights and the bias of layer  $i$  of a custom network to learn with `learnh`,

- 1 Set `net.trainFcn` to 'trainr'. (`net.trainParam` automatically becomes `trainr`'s default parameters.)
- 2 Set `net.adaptFcn` to 'trains'. (`net.adaptParam` automatically becomes `trains`'s default parameters.)
- 3 Set each `net.inputWeights{i,j}.learnFcn` to 'learnh'.
- 4 Set each `net.layerWeights{i,j}.learnFcn` to 'learnh'. (Each weight learning parameter property is automatically set to `learnh`'s default parameters.)

To train the network (or enable it to adapt),

- 1 Set `net.trainParam` (or `net.adaptParam`) properties to desired values.
- 2 Call `train` (`adapt`).

### Algorithms

`learnh` calculates the weight change  $dW$  for a given neuron from the neuron's input  $P$ , output  $A$ , and learning rate  $LR$  according to the Hebb learning rule:

```
dw = lr*a*p'
```

### References

Hebb, D.O., *The Organization of Behavior*, New York, Wiley, 1949

### See Also

`adapt` | `learnhd` | `train`

**Introduced before R2006a**

# learnhd

Hebb with decay weight learning rule

## Syntax

```
[dW,LS] = learnhd(W,P,Z,N,A,T,E,gW,gA,D,LP,LS)
info = learnhd('code')
```

## Description

learnhd is the Hebb weight learning function.

[dW,LS] = learnhd(W,P,Z,N,A,T,E,gW,gA,D,LP,LS) takes several inputs,

W	S-by-R weight matrix (or S-by-1 bias vector)
P	R-by-Q input vectors (or ones (1, Q))
Z	S-by-Q weighted input vectors
N	S-by-Q net input vectors
A	S-by-Q output vectors
T	S-by-Q layer target vectors
E	S-by-Q layer error vectors
gW	S-by-R gradient with respect to performance
gA	S-by-Q output gradient with respect to performance
D	S-by-S neuron distances
LP	Learning parameters, none, LP = []
LS	Learning state, initially should be = []

and returns

dW	S-by-R weight (or bias) change matrix
LS	New learning state

Learning occurs according to learnhd's learning parameters, shown here with default values.

LP.dr - 0.01	Decay rate
LP.lr - 0.1	Learning rate

info = learnhd('code') returns useful information for each code character vector:

'pnames'	Names of learning parameters
'pdefaults'	Default learning parameters
'needg'	Returns 1 if this function uses gW or gA

## Examples

Here you define a random input **P**, output **A**, and weights **W** for a layer with a two-element input and three neurons. Also define the decay and learning rates.

```
p = rand(2,1);  
a = rand(3,1);  
w = rand(3,2);  
lp.dr = 0.05;  
lp.lr = 0.5;
```

Because `learnhd` only needs these values to calculate a weight change (see “Algorithm” below), use them to do so.

```
dW = learnhd(w,p,[],[],a,[],[],[],[],[],lp,[])
```

## Network Use

To prepare the weights and the bias of layer *i* of a custom network to learn with `learnhd`,

- 1 Set `net.trainFcn` to 'trainr'. (`net.trainParam` automatically becomes `trainr`'s default parameters.)
- 2 Set `net.adaptFcn` to 'trains'. (`net.adaptParam` automatically becomes `trains`'s default parameters.)
- 3 Set each `net.inputWeights{i,j}.learnFcn` to 'learnhd'.
- 4 Set each `net.layerWeights{i,j}.learnFcn` to 'learnhd'. (Each weight learning parameter property is automatically set to `learnhd`'s default parameters.)

To train the network (or enable it to adapt),

- 1 Set `net.trainParam` (or `net.adaptParam`) properties to desired values.
- 2 Call `train` (`adapt`).

## Algorithms

`learnhd` calculates the weight change  $dW$  for a given neuron from the neuron's input **P**, output **A**, decay rate **DR**, and learning rate **LR** according to the Hebb with decay learning rule:

$$dw = lr*a*p' - dr*w$$

## See Also

`adapt` | `learnh` | `train`

**Introduced before R2006a**



# learnis

Instar weight learning function

## Syntax

```
[dW,LS] = learnis(W,P,Z,N,A,T,E,gW,gA,D,LP,LS)
info = learnis('code')
```

## Description

learnis is the instar weight learning function.

[dW,LS] = learnis(W,P,Z,N,A,T,E,gW,gA,D,LP,LS) takes several inputs,

W	S-by-R weight matrix (or S-by-1 bias vector)
P	R-by-Q input vectors (or ones(1,Q))
Z	S-by-Q weighted input vectors
N	S-by-Q net input vectors
A	S-by-Q output vectors
T	S-by-Q layer target vectors
E	S-by-Q layer error vectors
gW	S-by-R gradient with respect to performance
gA	S-by-Q output gradient with respect to performance
D	S-by-S neuron distances
LP	Learning parameters, none, LP = []
LS	Learning state, initially should be = []

and returns

dW	S-by-R weight (or bias) change matrix
LS	New learning state

Learning occurs according to learnis's learning parameter, shown here with its default value.

LP.lr - 0.01	Learning rate
--------------	---------------

info = learnis('code') returns useful information for each *code* character vector:

'pnames'	Names of learning parameters
'pdefaults'	Default learning parameters
'needg'	Returns 1 if this function uses gW or gA

## Examples

Here you define a random input *P*, output *A*, and weight matrix *W* for a layer with a two-element input and three neurons. Also define the learning rate *LR*.

```
p = rand(2,1);  
a = rand(3,1);  
w = rand(3,2);  
lp.lr = 0.5;
```

Because `learnis` only needs these values to calculate a weight change (see “Algorithm” below), use them to do so.

```
dW = learnis(w,p,[],[],a,[],[],[],[],[],lp,[])
```

## Network Use

To prepare the weights and the bias of layer *i* of a custom network so that it can learn with `learnis`,

- 1 Set `net.trainFcn` to 'trainr'. (`net.trainParam` automatically becomes `trainr`'s default parameters.)
- 2 Set `net.adaptFcn` to 'trains'. (`net.adaptParam` automatically becomes `trains`'s default parameters.)
- 3 Set each `net.inputWeights{i,j}.learnFcn` to 'learnis'.
- 4 Set each `net.layerWeights{i,j}.learnFcn` to 'learnis'. (Each weight learning parameter property is automatically set to `learnis`'s default parameters.)

To train the network (or enable it to adapt),

- 1 Set `net.trainParam` (`net.adaptParam`) properties to desired values.
- 2 Call `train` (`adapt`).

## Algorithms

`learnis` calculates the weight change *dW* for a given neuron from the neuron's input *P*, output *A*, and learning rate *LR* according to the instar learning rule:

```
dw = lr*a*(p'-w)
```

## References

Grossberg, S., *Studies of the Mind and Brain*, Dordrecht, Holland, Reidel Press, 1982

## See Also

`adapt` | `learnk` | `learnos` | `train`

Introduced before R2006a

# learnk

Kohonen weight learning function

## Syntax

```
[dW,LS] = learnk(W,P,Z,N,A,T,E,gW,gA,D,LP,LS)
info = learnk('code')
```

## Description

learnk is the Kohonen weight learning function.

[dW,LS] = learnk(W,P,Z,N,A,T,E,gW,gA,D,LP,LS) takes several inputs,

W	S-by-R weight matrix (or S-by-1 bias vector)
P	R-by-Q input vectors (or ones(1,Q))
Z	S-by-Q weighted input vectors
N	S-by-Q net input vectors
A	S-by-Q output vectors
T	S-by-Q layer target vectors
E	S-by-Q layer error vectors
gW	S-by-R gradient with respect to performance
gA	S-by-Q output gradient with respect to performance
D	S-by-S neuron distances
LP	Learning parameters, none, LP = []
LS	Learning state, initially should be = []

and returns

dW	S-by-R weight (or bias) change matrix
LS	New learning state

Learning occurs according to learnk's learning parameter, shown here with its default value.

LP.lr - 0.01	Learning rate
--------------	---------------

info = learnk('code') returns useful information for each *code* character vector:

'pnames'	Names of learning parameters
'pdefaults'	Default learning parameters
'needg'	Returns 1 if this function uses gW or gA

## Examples

Here you define a random input  $P$ , output  $A$ , and weight matrix  $W$  for a layer with a two-element input and three neurons. Also define the learning rate  $LR$ .

```
p = rand(2,1);  
a = rand(3,1);  
w = rand(3,2);  
lp.lr = 0.5;
```

Because `learnk` only needs these values to calculate a weight change (see “Algorithm” below), use them to do so.

```
dW = learnk(w,p,[],[],a,[],[],[],[],[],lp,[])
```

## Network Use

To prepare the weights of layer  $i$  of a custom network to learn with `learnk`,

- 1 Set `net.trainFcn` to 'trainr'. (`net.trainParam` automatically becomes `trainr`'s default parameters.)
- 2 Set `net.adaptFcn` to 'trains'. (`net.adaptParam` automatically becomes `trains`'s default parameters.)
- 3 Set each `net.inputWeights{i,j}.learnFcn` to 'learnk'.
- 4 Set each `net.layerWeights{i,j}.learnFcn` to 'learnk'. (Each weight learning parameter property is automatically set to `learnk`'s default parameters.)

To train the network (or enable it to adapt),

- 1 Set `net.trainParam` (or `net.adaptParam`) properties as desired.
- 2 Call `train` (or `adapt`).

## Algorithms

`learnk` calculates the weight change  $dW$  for a given neuron from the neuron's input  $P$ , output  $A$ , and learning rate  $LR$  according to the Kohonen learning rule:

$$dw = lr*(p'-w), \text{ if } a \neq 0; = 0, \text{ otherwise}$$

## References

Kohonen, T., *Self-Organizing and Associative Memory*, New York, Springer-Verlag, 1984

## See Also

`adapt` | `learnis` | `learnos` | `train`

**Introduced before R2006a**

# learnlv1

LVQ1 weight learning function

## Syntax

```
[dW,LS] = learnlv1(W,P,Z,N,A,T,E,gW,gA,D,LP,LS)
info = learnlv1('code')
```

## Description

learnlv1 is the LVQ1 weight learning function.

[dW,LS] = learnlv1(W,P,Z,N,A,T,E,gW,gA,D,LP,LS) takes several inputs,

W	S-by-R weight matrix (or S-by-1 bias vector)
P	R-by-Q input vectors (or ones(1,Q))
Z	S-by-Q weighted input vectors
N	S-by-Q net input vectors
A	S-by-Q output vectors
T	S-by-Q layer target vectors
E	S-by-Q layer error vectors
gW	S-by-R gradient with respect to performance
gA	S-by-Q output gradient with respect to performance
D	S-by-S neuron distances
LP	Learning parameters, none, LP = []
LS	Learning state, initially should be = []

and returns

dW	S-by-R weight (or bias) change matrix
LS	New learning state

Learning occurs according to learnlv1's learning parameter, shown here with its default value.

LP.lr - 0.01	Learning rate
--------------	---------------

info = learnlv1('code') returns useful information for each *code* character vector:

'pnames'	Names of learning parameters
'pdefaults'	Default learning parameters
'needg'	Returns 1 if this function uses gW or gA

## Examples

Here you define a random input  $P$ , output  $A$ , weight matrix  $W$ , and output gradient  $gA$  for a layer with a two-element input and three neurons. Also define the learning rate  $LR$ .

```
p = rand(2,1);  
w = rand(3,2);  
a = compet(negdist(w,p));  
gA = [-1;1; 1];  
lp.lr = 0.5;
```

Because `learnlv1` only needs these values to calculate a weight change (see “Algorithm” below), use them to do so.

```
dW = learnlv1(w,p,[],[],a,[],[],[],gA,[],lp,[])
```

## Network Use

You can create a standard network that uses `learnlv1` with `lvqnet`. To prepare the weights of layer  $i$  of a custom network to learn with `learnlv1`,

- 1 Set `net.trainFcn` to 'trainr'. (`net.trainParam` automatically becomes `trainr`'s default parameters.)
- 2 Set `net.adaptFcn` to 'trains'. (`net.adaptParam` automatically becomes `trains`'s default parameters.)
- 3 Set each `net.inputWeights{i,j}.learnFcn` to 'learnlv1'.
- 4 Set each `net.layerWeights{i,j}.learnFcn` to 'learnlv1'. (Each weight learning parameter property is automatically set to `learnlv1`'s default parameters.)

To train the network (or enable it to adapt),

- 1 Set `net.trainParam` (or `net.adaptParam`) properties as desired.
- 2 Call `train` (or `adapt`).

## Algorithms

`learnlv1` calculates the weight change  $dW$  for a given neuron from the neuron's input  $P$ , output  $A$ , output gradient  $gA$ , and learning rate  $LR$ , according to the LVQ1 rule, given  $i$ , the index of the neuron whose output  $a(i)$  is 1:

$$dw(i,:) = +lr*(p-w(i,:)) \text{ if } gA(i) = 0; = -lr*(p-w(i,:)) \text{ if } gA(i) = -1$$

## See Also

`adapt` | `learnlv2` | `train`

**Introduced before R2006a**

# learnlv2

LVQ2.1 weight learning function

## Syntax

```
[dW,LS] = learnlv2(W,P,Z,N,A,T,E,gW,gA,D,LP,LS)
info = learnlv2('code')
```

## Description

learnlv2 is the LVQ2 weight learning function.

[dW,LS] = learnlv2(W,P,Z,N,A,T,E,gW,gA,D,LP,LS) takes several inputs,

W	S-by-R weight matrix (or S-by-1 bias vector)
P	R-by-Q input vectors (or ones (1, Q))
Z	S-by-Q weighted input vectors
N	S-by-Q net input vectors
A	S-by-Q output vectors
T	S-by-Q layer target vectors
E	S-by-Q layer error vectors
gW	S-by-R weight gradient with respect to performance
gA	S-by-Q output gradient with respect to performance
D	S-by-S neuron distances
LP	Learning parameters, none, LP = []
LS	Learning state, initially should be = []

and returns

dW	S-by-R weight (or bias) change matrix
LS	New learning state

Learning occurs according to learnlv2's learning parameter, shown here with its default value.

LP.lr - 0.01	Learning rate
LP.window - 0.25	Window size (0 to 1, typically 0.2 to 0.3)

info = learnlv2('code') returns useful information for each *code* character vector:

'pnames'	Names of learning parameters
'pdefaults'	Default learning parameters
'needg'	Returns 1 if this function uses gW or gA

## Examples

Here you define a sample input  $P$ , output  $A$ , weight matrix  $W$ , and output gradient  $gA$  for a layer with a two-element input and three neurons. Also define the learning rate  $LR$ .

```
p = rand(2,1);  
w = rand(3,2);  
n = negdist(w,p);  
a = compet(n);  
gA = [-1;1; 1];  
lp.lr = 0.5;
```

Because `learnlv2` only needs these values to calculate a weight change (see “Algorithm” below), use them to do so.

```
dW = learnlv2(w,p,[],n,a,[],[],[],gA,[],lp,[])
```

## Network Use

You can create a standard network that uses `learnlv2` with `lvqnet`.

To prepare the weights of layer  $i$  of a custom network to learn with `learnlv2`,

- 1 Set `net.trainFcn` to 'trainr'. (`net.trainParam` automatically becomes `trainr`'s default parameters.)
- 2 Set `net.adaptFcn` to 'trains'. (`net.adaptParam` automatically becomes `trains`'s default parameters.)
- 3 Set each `net.inputWeights{i,j}.learnFcn` to 'learnlv2'.
- 4 Set each `net.layerWeights{i,j}.learnFcn` to 'learnlv2'. (Each weight learning parameter property is automatically set to `learnlv2`'s default parameters.)

To train the network (or enable it to adapt),

- 1 Set `net.trainParam` (or `net.adaptParam`) properties as desired.
- 2 Call `train` (or `adapt`).

## Algorithms

`learnlv2` implements Learning Vector Quantization 2.1, which works as follows:

For each presentation, if the winning neuron  $i$  should not have won, and the runnerup  $j$  should have, and the distance  $d_i$  between the winning neuron and the input  $p$  is roughly equal to the distance  $d_j$  from the runnerup neuron to the input  $p$  according to the given window,

$$\min(d_i/d_j, d_j/d_i) > (1-\text{window})/(1+\text{window})$$

then move the winning neuron  $i$  weights away from the input vector, and move the runnerup neuron  $j$  weights toward the input according to

```
dw(i,:) = - lp.lr*(p'-w(i,:))  
dw(j,:) = + lp.lr*(p'-w(j,:))
```



**See Also**

`adapt` | `learnlv1` | `train`

**Introduced before R2006a**

# learnos

Outstar weight learning function

## Syntax

```
[dW,LS] = learnos(W,P,Z,N,A,T,E,gW,gA,D,LP,LS)
info = learnos('code')
```

## Description

learnos is the outstar weight learning function.

[dW,LS] = learnos(W,P,Z,N,A,T,E,gW,gA,D,LP,LS) takes several inputs,

W	S-by-R weight matrix (or S-by-1 bias vector)
P	R-by-Q input vectors (or ones(1,Q))
Z	S-by-Q weighted input vectors
N	S-by-Q net input vectors
A	S-by-Q output vectors
T	S-by-Q layer target vectors
E	S-by-Q layer error vectors
gW	S-by-R weight gradient with respect to performance
gA	S-by-Q output gradient with respect to performance
D	S-by-S neuron distances
LP	Learning parameters, none, LP = []
LS	Learning state, initially should be = []

and returns

dW	S-by-R weight (or bias) change matrix
LS	New learning state

Learning occurs according to learnos's learning parameter, shown here with its default value.

LP.lr - 0.01	Learning rate
--------------	---------------

info = learnos('code') returns useful information for each code character vector:

'pnames'	Names of learning parameters
'pdefaults'	Default learning parameters
'needg'	Returns 1 if this function uses gW or gA

## Examples

Here you define a random input  $P$ , output  $A$ , and weight matrix  $W$  for a layer with a two-element input and three neurons. Also define the learning rate  $LR$ .

```
p = rand(2,1);
a = rand(3,1);
w = rand(3,2);
lp.lr = 0.5;
```

Because `learnos` only needs these values to calculate a weight change (see “Algorithm” below), use them to do so.

```
dW = learnos(w,p,[],[],a,[],[],[],[],[],lp,[])
```

## Network Use

To prepare the weights and the bias of layer  $i$  of a custom network to learn with `learnos`,

- 1 Set `net.trainFcn` to 'trainr'. (`net.trainParam` automatically becomes `trainr`'s default parameters.)
- 2 Set `net.adaptFcn` to 'trains'. (`net.adaptParam` automatically becomes `trains`'s default parameters.)
- 3 Set each `net.inputWeights{i,j}.learnFcn` to 'learnos'.
- 4 Set each `net.layerWeights{i,j}.learnFcn` to 'learnos'. (Each weight learning parameter property is automatically set to `learnos`'s default parameters.)

To train the network (or enable it to adapt),

- 1 Set `net.trainParam` (or `net.adaptParam`) properties to desired values.
- 2 Call `train` (adapt).

## Algorithms

`learnos` calculates the weight change  $dW$  for a given neuron from the neuron's input  $P$ , output  $A$ , and learning rate  $LR$  according to the outstar learning rule:

```
dw = lr*(a-w)*p'
```

## References

Grossberg, S., *Studies of the Mind and Brain*, Dordrecht, Holland, Reidel Press, 1982

## See Also

`adapt` | `learnis` | `learnk` | `train`

Introduced before R2006a

## learnp

Perceptron weight and bias learning function

### Syntax

```
[dW,LS] = learnp(W,P,Z,N,A,T,E,gW,gA,D,LP,LS)
info = learnp('code')
```

### Description

learnp is the perceptron weight/bias learning function.

[dW,LS] = learnp(W,P,Z,N,A,T,E,gW,gA,D,LP,LS) takes several inputs,

W	S-by-R weight matrix (or b, and S-by-1 bias vector)
P	R-by-Q input vectors (or ones (1, Q))
Z	S-by-Q weighted input vectors
N	S-by-Q net input vectors
A	S-by-Q output vectors
T	S-by-Q layer target vectors
E	S-by-Q layer error vectors
gW	S-by-R weight gradient with respect to performance
gA	S-by-Q output gradient with respect to performance
D	S-by-S neuron distances
LP	Learning parameters, none, LP = []
LS	Learning state, initially should be = []

and returns

dW	S-by-R weight (or bias) change matrix
LS	New learning state

info = learnp('code') returns useful information for each *code* character vector:

'pnames'	Names of learning parameters
'pdefaults'	Default learning parameters
'needg'	Returns 1 if this function uses gW or gA

### Examples

Here you define a random input P and error E for a layer with a two-element input and three neurons.

```
p = rand(2,1);
e = rand(3,1);
```

Because `learnp` only needs these values to calculate a weight change (see “Algorithm” below), use them to do so.

```
dw = learnp([], p, [], [], [], [], e, [], [], [], [], [])
```

## Algorithms

`learnp` calculates the weight change  $dw$  for a given neuron from the neuron’s input  $P$  and error  $E$  according to the perceptron learning rule:

$$\begin{aligned} dw &= 0, \text{ if } e = 0 \\ &= p', \text{ if } e = 1 \\ &= -p', \text{ if } e = -1 \end{aligned}$$

This can be summarized as

$$dw = e * p'$$

## References

Rosenblatt, F., *Principles of Neurodynamics*, Washington, D.C., Spartan Press, 1961

## See Also

[adapt](#) | [learnpn](#) | [train](#)

**Introduced before R2006a**

## learnpn

Normalized perceptron weight and bias learning function

### Syntax

```
[dW,LS] = learnpn(W,P,Z,N,A,T,E,gW,gA,D,LP,LS)
info = learnpn('code')
```

### Description

Learnpn is a weight and bias learning function. It can result in faster learning than learnp when input vectors have widely varying magnitudes.

[dW,LS] = learnpn(W,P,Z,N,A,T,E,gW,gA,D,LP,LS) takes several inputs,

W	S-by-R weight matrix (or S-by-1 bias vector)
P	R-by-Q input vectors (or ones (1,Q))
Z	S-by-Q weighted input vectors
N	S-by-Q net input vectors
A	S-by-Q output vectors
T	S-by-Q layer target vectors
E	S-by-Q layer error vectors
gW	S-by-R weight gradient with respect to performance
gA	S-by-Q output gradient with respect to performance
D	S-by-S neuron distances
LP	Learning parameters, none, LP = []
LS	Learning state, initially should be = []

and returns

dW	S-by-R weight (or bias) change matrix
LS	New learning state

info = learnpn('code') returns useful information for each *code* character vector:

'pnames'	Names of learning parameters
'pdefaults'	Default learning parameters
'needg'	Returns 1 if this function uses gW or gA

### Examples

Here you define a random input P and error E for a layer with a two-element input and three neurons.

```
p = rand(2,1);
e = rand(3,1);
```

Because `learnpn` only needs these values to calculate a weight change (see “Algorithm” below), use them to do so.

```
dW = learnpn([],p,[],[],[],[],e,[],[],[],[],[])
```

## Limitations

Perceptrons do have one real limitation. The set of input vectors must be linearly separable if a solution is to be found. That is, if the input vectors with targets of 1 cannot be separated by a line or hyperplane from the input vectors associated with values of 0, the perceptron will never be able to classify them correctly.

## Algorithms

`learnpn` calculates the weight change  $dW$  for a given neuron from the neuron’s input  $P$  and error  $E$  according to the normalized perceptron learning rule:

$$pn = p / \sqrt{1 + p(1)^2 + p(2)^2 + \dots + p(R)^2}$$

$$dw = \begin{cases} 0, & \text{if } e = 0 \\ pn', & \text{if } e = 1 \\ -pn', & \text{if } e = -1 \end{cases}$$

The expression for  $dW$  can be summarized as

$$dw = e * pn'$$

## See Also

`adapt` | `learnp` | `train`

**Introduced before R2006a**

## learnsom

Self-organizing map weight learning function

### Syntax

```
[dW,LS] = learnsom(W,P,Z,N,A,T,E,gW,gA,D,LP,LS)
info = learnsom('code')
```

### Description

learnsom is the self-organizing map weight learning function.

[dW,LS] = learnsom(W,P,Z,N,A,T,E,gW,gA,D,LP,LS) takes several inputs,

W	S-by-R weight matrix (or S-by-1 bias vector)
P	R-by-Q input vectors (or ones (1, Q))
Z	S-by-Q weighted input vectors
N	S-by-Q net input vectors
A	S-by-Q output vectors
T	S-by-Q layer target vectors
E	S-by-Q layer error vectors
gW	S-by-R weight gradient with respect to performance
gA	S-by-Q output gradient with respect to performance
D	S-by-S neuron distances
LP	Learning parameters, none, LP = []
LS	Learning state, initially should be = []

and returns

dW	S-by-R weight (or bias) change matrix
LS	New learning state

Learning occurs according to learnsom's learning parameters, shown here with their default values.

LP.order_lr	0.9	Ordering phase learning rate
LP.order_steps	1000	Ordering phase steps
LP.tune_lr	0.02	Tuning phase learning rate
LP.tune_nd	1	Tuning phase neighborhood distance

info = learnsom('code') returns useful information for each code character vector:

'pnames'	Names of learning parameters
----------	------------------------------



'pdefaults'	Default learning parameters
'needg'	Returns 1 if this function uses gW or gA

## Examples

Here you define a random input P, output A, and weight matrix W for a layer with a two-element input and six neurons. You also calculate positions and distances for the neurons, which are arranged in a 2-by-3 hexagonal pattern. Then you define the four learning parameters.

```
p = rand(2,1);
a = rand(6,1);
w = rand(6,2);
pos = hextop(2,3);
d = linkdist(pos);
lp.order_lr = 0.9;
lp.order_steps = 1000;
lp.tune_lr = 0.02;
lp.tune_nd = 1;
```

Because learnsom only needs these values to calculate a weight change (see “Algorithm” below), use them to do so.

```
ls = [];
[dW,ls] = learnsom(w,p,[],[],a,[],[],[],[],d,lp,ls)
```

## Algorithms

learnsom calculates the weight change  $dW$  for a given neuron from the neuron’s input P, activation A2, and learning rate LR:

$$dw = lr * a2 * (p' - w)$$

where the activation A2 is found from the layer output A, neuron distances D, and the current neighborhood size ND:

$$a2(i,q) = \begin{cases} 1, & \text{if } a(i,q) = 1 \\ 0.5, & \text{if } a(j,q) = 1 \text{ and } D(i,j) \leq nd \\ 0, & \text{otherwise} \end{cases}$$

The learning rate LR and neighborhood size NS are altered through two phases: an ordering phase and a tuning phase.

The ordering phases lasts as many steps as LP.order\_steps. During this phase LR is adjusted from LP.order\_lr down to LP.tune\_lr, and ND is adjusted from the maximum neuron distance down to 1. It is during this phase that neuron weights are expected to order themselves in the input space consistent with the associated neuron positions.

During the tuning phase LR decreases slowly from LP.tune\_lr, and ND is always set to LP.tune\_nd. During this phase the weights are expected to spread out relatively evenly over the input space while retaining their topological order, determined during the ordering phase.

## See Also

adapt | train

**Introduced before R2006a**

# learnsomb

Batch self-organizing map weight learning function

## Syntax

```
[dW,LS] = learnsomb(W,P,Z,N,A,T,E,gW,gA,D,LP,LS)
info = learnsomb('code')
```

## Description

learnsomb is the batch self-organizing map weight learning function.

[dW,LS] = learnsomb(W,P,Z,N,A,T,E,gW,gA,D,LP,LS) takes several inputs:

W	S-by-R weight matrix (or S-by-1 bias vector)
P	R-by-Q input vectors (or ones (1, Q))
Z	S-by-Q weighted input vectors
N	S-by-Q net input vectors
A	S-by-Q output vectors
T	S-by-Q layer target vectors
E	S-by-Q layer error vectors
gW	S-by-R gradient with respect to performance
gA	S-by-Q output gradient with respect to performance
D	S-by-S neuron distances
LP	Learning parameters, none, LP = []
LS	Learning state, initially should be = []

and returns the following:

dW	S-by-R weight (or bias) change matrix
LS	New learning state

Learning occurs according to learnsomb's learning parameter, shown here with its default value:

LP.init_neighborhood	3	Initial neighborhood size
LP.steps	100	Ordering phase steps

info = learnsomb('code') returns useful information for each *code* character vector:

'pnames'	Returns names of learning parameters.
'pdefaults'	Returns default learning parameters.
'needg'	Returns 1 if this function uses gW or gA.

## Examples

This example defines a random input *P*, output *A*, and weight matrix *W* for a layer with a 2-element input and 6 neurons. This example also calculates the positions and distances for the neurons, which appear in a 2-by-3 hexagonal pattern.

```
p = rand(2,1);
a = rand(6,1);
w = rand(6,2);
pos = hextop(2,3);
d = linkdist(pos);
lp = learnsomb('pdefaults');
```

Because `learnsomb` only needs these values to calculate a weight change (see Algorithm).

```
ls = [];
[dW,ls] = learnsomb(w,p,[],[],a,[],[],[],[],d,lp,ls)
```

## Network Use

You can create a standard network that uses `learnsomb` with `selforgmap`. To prepare the weights of layer *i* of a custom network to learn with `learnsomb`:

- 1 Set `NET.trainFcn` to `'trainr'`. (`NET.trainParam` automatically becomes `trainr`'s default parameters.)
- 2 Set `NET.adaptFcn` to `'trains'`. (`NET.adaptParam` automatically becomes `trains`'s default parameters.)
- 3 Set each `NET.inputWeights{i,j}.learnFcn` to `'learnsomb'`.
- 4 Set each `NET.layerWeights{i,j}.learnFcn` to `'learnsomb'`. (Each weight learning parameter property is automatically set to `learnsomb`'s default parameters.)

To train the network (or enable it to adapt):

- 1 Set `NET.trainParam` (or `NET.adaptParam`) properties as desired.
- 2 Call `train` (or `adapt`).

## Algorithms

`learnsomb` calculates the weight changes so that each neuron's new weight vector is the weighted average of the input vectors that the neuron and neurons in its neighborhood responded to with an output of 1.

The ordering phase lasts as many steps as `LP.steps`.

During this phase, the neighborhood is gradually reduced from a maximum size of `LP.init_neighborhood` down to 1, where it remains from then on.

## See Also

`adapt` | `selforgmap` | `train`

**Introduced in R2008a**

# learnwh

Widrow-Hoff weight/bias learning function

## Syntax

```
[dW,LS] = learnwh(W,P,Z,N,A,T,E,gW,gA,D,LP,LS)
info = learnwh('code')
```

## Description

`learnwh` is the Widrow-Hoff weight/bias learning function, and is also known as the delta or least mean squared (LMS) rule.

`[dW,LS] = learnwh(W,P,Z,N,A,T,E,gW,gA,D,LP,LS)` takes several inputs,

W	S-by-R weight matrix (or b, and S-by-1 bias vector)
P	R-by-Q input vectors (or ones (1,Q))
Z	S-by-Q weighted input vectors
N	S-by-Q net input vectors
A	S-by-Q output vectors
T	S-by-Q layer target vectors
E	S-by-Q layer error vectors
gW	S-by-R weight gradient with respect to performance
gA	S-by-Q output gradient with respect to performance
D	S-by-S neuron distances
LP	Learning parameters, none, LP = []
LS	Learning state, initially should be = []

and returns

dW	S-by-R weight (or bias) change matrix
LS	New learning state

Learning occurs according to the `learnwh` learning parameter, shown here with its default value.

LP.lr – 0.01	Learning rate
--------------	---------------

`info = learnwh('code')` returns useful information for each `code` character vector:

'pnames'	Names of learning parameters
'pdefaults'	Default learning parameters
'needg'	Returns 1 if this function uses gW or gA

## Examples

Here you define a random input **P** and error **E** for a layer with a two-element input and three neurons. You also define the learning rate **LR** learning parameter.

```
p = rand(2,1);  
e = rand(3,1);  
lp.lr = 0.5;
```

Because `learnwh` needs only these values to calculate a weight change (see “Algorithm” below), use them to do so.

```
dW = learnwh([],p,[],[],[],[],e,[],[],[],lp,[])
```

## Network Use

You can create a standard network that uses `learnwh` with `linearlayer`.

To prepare the weights and the bias of layer **i** of a custom network to learn with `learnwh`,

- 1 Set `net.trainFcn` to 'trainb'. `net.trainParam` automatically becomes `trainb`'s default parameters.
- 2 Set `net.adaptFcn` to 'trains'. `net.adaptParam` automatically becomes `trains`'s default parameters.
- 3 Set each `net.inputWeights{i,j}.learnFcn` to 'learnwh'.
- 4 Set each `net.layerWeights{i,j}.learnFcn` to 'learnwh'.
- 5 Set `net.biases{i}.learnFcn` to 'learnwh'. Each weight and bias learning parameter property is automatically set to the `learnwh` default parameters.

To train the network (or enable it to adapt),

- 1 Set `net.trainParam` (or `net.adaptParam`) properties to desired values.
- 2 Call `train` (or `adapt`).

## Algorithms

`learnwh` calculates the weight change **dW** for a given neuron from the neuron's input **P** and error **E**, and the weight (or bias) learning rate **LR**, according to the Widrow-Hoff learning rule:

```
dw = lr*e*pn'
```

## References

Widrow, B., and M.E. Hoff, “Adaptive switching circuits,” *1960 IRE WESCON Convention Record*, New York IRE, pp. 96-104, 1960

Widrow, B., and S.D. Sterns, *Adaptive Signal Processing*, New York, Prentice-Hall, 1985

## See Also

`adapt` | `linearlayer` | `train`

**Introduced before R2006a**

# linearlayer

Linear layer

## Syntax

```
linearlayer(inputDelays, widrowHoffLR)
```

## Description

Linear layers are single layers of linear neurons. They may be static, with input delays of 0, or dynamic, with input delays greater than 0. They can be trained on simple linear time series problems, but often are used adaptively to continue learning while deployed so they can adjust to changes in the relationship between inputs and outputs while being used.

If a network is needed to solve a nonlinear time series relationship, then better networks to try include `timedelaynet`, `narxnet`, and `narnet`.

`linearlayer(inputDelays, widrowHoffLR)` takes these arguments,

<code>inputDelays</code>	Row vector of increasing 0 or positive delays (default = 0)
<code>widrowHoffLR</code>	Widrow-Hoff learning rate (default = 0.01)

and returns a linear layer.

If the learning rate is too small, learning will happen very slowly. However, a greater danger is that it may be too large and learning will become unstable resulting in large changes to weight vectors and errors increasing instead of decreasing. If a data set is available which characterizes the relationship the layer is to learn, the maximum stable learning rate can be calculated with `maxlinlr`.

## Examples

### Create and Train a Linear Layer

Here a linear layer is trained on a simple time series problem.

```
x = {0 -1 1 1 0 -1 1 0 0 1};
t = {0 -1 0 2 1 -1 0 1 0 1};
net = linearlayer(1:2,0.01);
[Xs,Xi,Ai,Ts] = preparets(net,x,t);
net = train(net,Xs,Ts,Xi,Ai);
view(net)
Y = net(Xs,Xi);
perf = perform(net,Ts,Y)
```

```
perf =
```

```
    0.2396
```



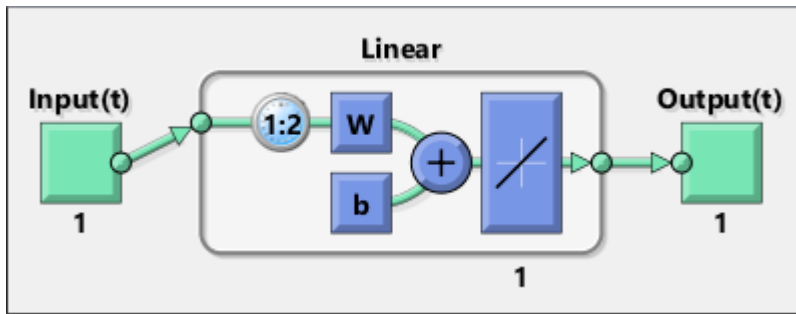

### See Also

narnet | narxnet | preparets | removedelay | timedelaynet

**Introduced in R2010b**

## linkdist

Link distance function

### Syntax

```
d = linkdist(pos)
```

### Description

`linkdist` is a layer distance function used to find the distances between the layer's neurons given their positions.

`d = linkdist(pos)` takes one argument,

<code>pos</code>	N-by-S matrix of neuron positions
------------------	-----------------------------------

and returns the S-by-S matrix of distances.

### Examples

Here you define a random matrix of positions for 10 neurons arranged in three-dimensional space and find their distances.

```
pos = rand(3,10);  
D = linkdist(pos)
```

### Network Use

You can create a standard network that uses `linkdist` as a distance function by calling `selforgmap`.

To change a network so that a layer's topology uses `linkdist`, set `net.layers{i}.distanceFcn` to `'linkdist'`.

In either case, call `sim` to simulate the network with `dist`.

### Algorithms

The link distance  $D$  between two position vectors  $P_i$  and  $P_j$  from a set of  $S$  vectors is

```
Dij = 0, if i == j  
      = 1, if (sum((Pi-Pj).^2)).^0.5 is <= 1  
      = 2, if k exists, Dik = Dkj = 1  
      = 3, if k1, k2 exist, Dik1 = Dk1k2 = Dk2j = 1  
      = N, if k1..kN exist, Dik1 = Dk1k2 = ... = DkNj = 1  
      = S, if none of the above conditions apply
```

### See Also

`dist` | `mandist` | `selforgmap` | `sim`

**Introduced before R2006a**

## logsig

Log-sigmoid transfer function

### Graph and Symbol

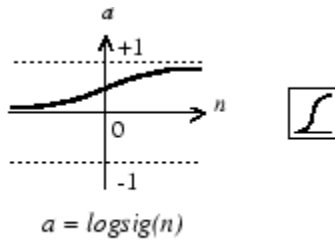

Log-Sigmoid Transfer Function

### Syntax

```
A = logsig(N,FP)
dA_dN = logsig('dn',N,A,FP)
info = logsig('code')
```

### Description

`logsig` is a transfer function. Transfer functions calculate a layer's output from its net input.

`A = logsig(N,FP)` takes `N` and optional function parameters,

<code>N</code>	S-by-Q matrix of net input (column) vectors
<code>FP</code>	Struct of function parameters (ignored)

and returns `A`, the S-by-Q matrix of `N`'s elements squashed into `[0, 1]`.

`dA_dN = logsig('dn',N,A,FP)` returns the S-by-Q derivative of `A` with respect to `N`. If `A` or `FP` is not supplied or is set to `[]`, `FP` reverts to the default parameters, and `A` is calculated from `N`.

`info = logsig('code')` returns useful information for each `code` character vector:

`logsig('name')` returns the name of this function.

`logsig('output',FP)` returns the `[min max]` output range.

`logsig('active',FP)` returns the `[min max]` active input range.

`logsig('fullderiv')` returns 1 or 0, depending on whether `dA_dN` is S-by-S-by-Q or S-by-Q.

`logsig('fpnames')` returns the names of the function parameters.

`logsig('fpdefaults')` returns the default function parameters.

## Examples

Here is the code to create a plot of the `logsig` transfer function.

```
n = -5:0.1:5;  
a = logsig(n);  
plot(n,a)
```

Assign this transfer function to layer `i` of a network.

```
net.layers{i}.transferFcn = 'logsig';
```

## Algorithms

$\text{logsig}(n) = 1 / (1 + \exp(-n))$

## See Also

`sim` | `tansig`

**Introduced before R2006a**

## lvqnet

Learning vector quantization neural network

### Syntax

```
lvqnet(hiddenSize,lvqLR,lvqLF)
```

### Description

LVQ (learning vector quantization) neural networks consist of two layers. The first layer maps input vectors into clusters that are found by the network during training. The second layer merges groups of first layer clusters into the classes defined by the target data.

The total number of first layer clusters is determined by the number of hidden neurons. The larger the hidden layer the more clusters the first layer can learn, and the more complex mapping of input to target classes can be made. The relative number of first layer clusters assigned to each target class are determined according to the distribution of target classes at the time of network initialization. This occurs when the network is automatically configured the first time `train` is called, or manually configured with the function `configure`, or manually initialized with the function `init` is called.

`lvqnet(hiddenSize,lvqLR,lvqLF)` takes these arguments,

<code>hiddenSize</code>	Size of hidden layer (default = 10)
<code>lvqLR</code>	LVQ learning rate (default = 0.01)
<code>lvqLF</code>	LVQ learning function (default = 'learnlv1')

and returns an LVQ neural network.

The other option for the `lvq` learning function is `learnlv2`.

### Examples

#### Train a Learning Vector Quantization Network

Here, an LVQ network is trained to classify iris flowers.

```
[x,t] = iris_dataset;
net = lvqnet(10);
net.trainParam.epochs = 50;
net = train(net,x,t);
view(net)
y = net(x);
perf = perform(net,y,t)
classes = vec2ind(y);
```

```
perf =
    0.0489
```

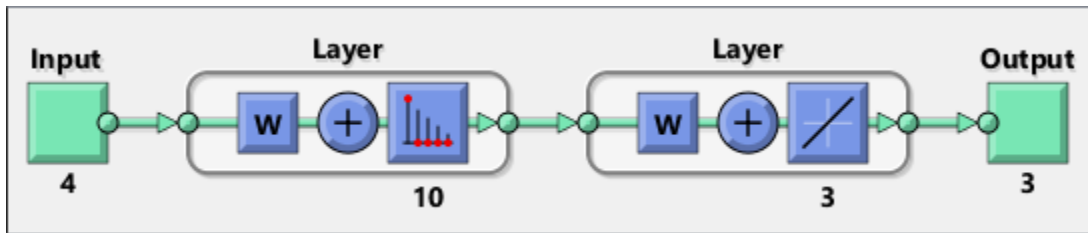

### See Also

`competlayer` | `patternnet` | `selforgmap`

**Introduced in R2010b**

## lvqoutputs

LVQ outputs processing function

### Syntax

```
[X,settings] = lvqoutputs(X)
X = lvqoutputs('apply',X,PS)
X = lvqoutputs('reverse',X,PS)
dx_dy = lvqoutputs('dx_dy',X,X,PS)
```

### Description

`[X,settings] = lvqoutputs(X)` returns its argument unchanged, but stores the ratio of target classes in the settings for use by `initlvq` to initialize weights.

`X = lvqoutputs('apply',X,PS)` returns X.

`X = lvqoutputs('reverse',X,PS)` returns X.

`dx_dy = lvqoutputs('dx_dy',X,X,PS)` returns the identity derivative.

### See Also

`initlvq` | `lvqnet`

**Introduced in R2010b**



## mae

Mean absolute error performance function

### Syntax

```
perf = mae(E,Y,X,FP)
```

### Description

`mae` is a network performance function. It measures network performance as the mean of absolute errors.

`perf = mae(E,Y,X,FP)` takes `E` and optional function parameters,

E	Matrix or cell array of error vectors
Y	Matrix or cell array of output vectors (ignored)
X	Vector of all weight and bias values (ignored)
FP	Function parameters (ignored)

and returns the mean absolute error.

`dPerf_dx = mae('dx',E,Y,X,perf,FP)` returns the derivative of `perf` with respect to `X`.

`info = mae('code')` returns useful information for each `code` character vector:

`mae('name')` returns the name of this function.

`mae('pnames')` returns the names of the training parameters.

`mae('pdefaults')` returns the default function parameters.

### Examples

Create and configure a perceptron to have one input and one neuron:

```
net = perceptron;
net = configure(net,0,0);
```

The network is given a batch of inputs `P`. The error is calculated by subtracting the output `A` from target `T`. Then the mean absolute error is calculated.

```
p = [-10 -5 0 5 10];
t = [0 0 1 1 1];
y = net(p)
e = t-y
perf = mae(e)
```

Note that `mae` can be called with only one argument because the other arguments are ignored. `mae` supports those arguments to conform to the standard performance function argument list.

### Network Use

You can create a standard network that uses `mae` with `perceptron`.

To prepare a custom network to be trained with `mae`, set `net.performFcn` to `'mae'`. This automatically sets `net.performParam` to the empty matrix `[]`, because `mae` has no performance parameters.

In either case, calling `train` or `adapt`, results in `mae` being used to calculate performance.

### See Also

`mse` | `perceptron`

**Introduced before R2006a**

# mandist

Manhattan distance weight function

## Syntax

```
Z = mandist(W,P)
D = mandist(pos)
```

## Description

`mandist` is the Manhattan distance weight function. Weight functions apply weights to an input to get weighted inputs.

`Z = mandist(W,P)` takes these inputs,

W	S-by-R weight matrix
P	R-by-Q matrix of Q input (column) vectors

and returns the S-by-Q matrix of vector distances.

`mandist` is also a layer distance function, which can be used to find the distances between neurons in a layer.

`D = mandist(pos)` takes one argument,

pos	S row matrix of neuron positions
-----	----------------------------------

and returns the S-by-S matrix of distances.

## Examples

Here you define a random weight matrix `W` and input vector `P` and calculate the corresponding weighted input `Z`.

```
W = rand(4,3);
P = rand(3,1);
Z = mandist(W,P)
```

Here you define a random matrix of positions for 10 neurons arranged in three-dimensional space and then find their distances.

```
pos = rand(3,10);
D = mandist(pos)
```

## Network Use

To change a network so an input weight uses `mandist`, set `net.inputWeights{i,j}.weightFcn` to 'mandist'. For a layer weight, set `net.layerWeights{i,j}.weightFcn` to 'mandist'.

To change a network so a layer's topology uses `mandist`, set `net.layers{i}.distanceFcn` to `'mandist'`.

In either case, call `sim` to simulate the network with `dist`. See `newpnn` or `newgrnn` for simulation examples.

### Algorithms

The Manhattan distance  $D$  between two vectors  $X$  and  $Y$  is

$$D = \text{sum}(\text{abs}(x-y))$$

### See Also

`dist` | `linkdist` | `sim`

**Introduced before R2006a**

# mapminmax

Process matrices by mapping row minimum and maximum values to [-1 1]

## Syntax

```
[Y,PS] = mapminmax(X,YMIN,YMAX)
[Y,PS] = mapminmax(X,FP)
Y = mapminmax('apply',X,PS)
X = mapminmax('reverse',Y,PS)
dx_dy = mapminmax('dx_dy',X,Y,PS)
```

## Description

mapminmax processes matrices by normalizing the minimum and maximum values of each row to [YMIN, YMAX].

[Y,PS] = mapminmax(X,YMIN,YMAX) takes X and optional parameters

X	N-by-Q matrix
YMIN	Minimum value for each row of Y (default is -1)
YMAX	Maximum value for each row of Y (default is +1)

and returns

Y	N-by-Q matrix
PS	Process settings that allow consistent processing of values

[Y,PS] = mapminmax(X,FP) takes parameters as a struct: FP.ymin, FP.ymax.

Y = mapminmax('apply',X,PS) returns Y, given X and settings PS.

X = mapminmax('reverse',Y,PS) returns X, given Y and settings PS.

dx\_dy = mapminmax('dx\_dy',X,Y,PS) returns the reverse derivative.

## Examples

Here is how to format a matrix so that the minimum and maximum values of each row are mapped to default interval [-1,+1].

```
x1 = [1 2 4; 1 1 1; 3 2 2; 0 0 0]
[y1,PS] = mapminmax(x1)
```

Next, apply the same processing settings to new values.

```
x2 = [5 2 3; 1 1 1; 6 7 3; 0 0 0]
y2 = mapminmax('apply',x2,PS)
```

Reverse the processing of y1 to get x1 again.

```
x1_again = mapminmax('reverse',y1,PS)
```

## More About

### Normalize Inputs and Targets Using `mapminmax`

Before training, it is often useful to scale the inputs and targets so that they always fall within a specified range. The function `mapminmax` scales inputs and targets so that they fall in the range  $[-1,1]$ . The following code illustrates how to use this function.

```
[pn,ps] = mapminmax(p);  
[tn,ts] = mapminmax(t);  
net = train(net,pn,tn);
```

The original network inputs and targets are given in the matrices `p` and `t`. The normalized inputs and targets `pn` and `tn` that are returned will all fall in the interval  $[-1,1]$ . The structures `ps` and `ts` contain the settings, in this case the minimum and maximum values of the original inputs and targets. After the network has been trained, the `ps` settings should be used to transform any future inputs that are applied to the network. They effectively become a part of the network, just like the network weights and biases.

If `mapminmax` is used to scale the targets, then the output of the network will be trained to produce outputs in the range  $[-1,1]$ . To convert these outputs back into the same units that were used for the original targets, use the settings `ts`. The following code simulates the network that was trained in the previous code, and then converts the network output back into the original units.

```
an = sim(net,pn);  
a = mapminmax('reverse',an,ts);
```

The network output `an` corresponds to the normalized targets `tn`. The unnormalized network output `a` is in the same units as the original targets `t`.

If `mapminmax` is used to preprocess the training set data, then whenever the trained network is used with new inputs they should be preprocessed with the minimum and maximums that were computed for the training set stored in the settings `ps`. The following code applies a new set of inputs to the network already trained.

```
pnewn = mapminmax('apply',pnew,ps);  
anewn = sim(net,pnewn);  
anew = mapminmax('reverse',anewn,ts);
```

For most networks, including `feedforwardnet`, these steps are done automatically, so that you only need to use the `sim` command.

## Algorithms

It is assumed that  $X$  has only finite real values, and that the elements of each row are not all equal. (If  $x_{\max}=x_{\min}$  or if either  $x_{\max}$  or  $x_{\min}$  are non-finite, then  $y=x$  and no change occurs.)

```
y = (ymax-ymin)*(x-xmin)/(xmax-xmin) + ymin;
```

## See Also

`fixunknowns` | `mapstd` | `processpca`

**Introduced in R2006a**

## mapstd

Process matrices by mapping each row's means to 0 and deviations to 1

### Syntax

```
[Y,PS] = mapstd(X,ymean,ystd)
[Y,PS] = mapstd(X,FP)
Y = mapstd('apply',X,PS)
X = mapstd('reverse',Y,PS)
dx_dy = mapstd('dx_dy',X,Y,PS)
```

### Description

mapstd processes matrices by transforming the mean and standard deviation of each row to ymean and ystd.

[Y,PS] = mapstd(X,ymean,ystd) takes X and optional parameters,

X	N-by-Q matrix
ymean	Mean value for each row of Y (default is 0)
ystd	Standard deviation for each row of Y (default is 1)

and returns

Y	N-by-Q matrix
PS	Process settings that allow consistent processing of values

[Y,PS] = mapstd(X,FP) takes parameters as a struct: FP.ymean, FP.ystd.

Y = mapstd('apply',X,PS) returns Y, given X and settings PS.

X = mapstd('reverse',Y,PS) returns X, given Y and settings PS.

dx\_dy = mapstd('dx\_dy',X,Y,PS) returns the reverse derivative.

### Examples

Here you format a matrix so that the minimum and maximum values of each row are mapped to default mean and STD of 0 and 1.

```
x1 = [1 2 4; 1 1 1; 3 2 2; 0 0 0]
[y1,PS] = mapstd(x1)
```

Next, apply the same processing settings to new values.

```
x2 = [5 2 3; 1 1 1; 6 7 3; 0 0 0]
y2 = mapstd('apply',x2,PS)
```

Reverse the processing of y1 to get x1 again.



```
x1_again = mapstd('reverse',y1,PS)
```

## More About

### Normalize Network Inputs and Targets Using mapstd

Another approach for scaling network inputs and targets is to normalize the mean and standard deviation of the training set. The function `mapstd` normalizes the inputs and targets so that they will have zero mean and unity standard deviation. The following code illustrates the use of `mapstd`.

```
[pn,ps] = mapstd(p);
[tn,ts] = mapstd(t);
```

The original network inputs and targets are given in the matrices `p` and `t`. The normalized inputs and targets `pn` and `tn` that are returned will have zero means and unity standard deviation. The settings structures `ps` and `ts` contain the means and standard deviations of the original inputs and original targets. After the network has been trained, you should use these settings to transform any future inputs that are applied to the network. They effectively become a part of the network, just like the network weights and biases.

If `mapstd` is used to scale the targets, then the output of the network is trained to produce outputs with zero mean and unity standard deviation. To convert these outputs back into the same units that were used for the original targets, use `ts`. The following code simulates the network that was trained in the previous code, and then converts the network output back into the original units.

```
an = sim(net,pn);
a = mapstd('reverse',an,ts);
```

The network output `an` corresponds to the normalized targets `tn`. The unnormalized network output `a` is in the same units as the original targets `t`.

If `mapstd` is used to preprocess the training set data, then whenever the trained network is used with new inputs, you should preprocess them with the means and standard deviations that were computed for the training set using `ps`. The following commands apply a new set of inputs to the network already trained:

```
pnewn = mapstd('apply',pnew,ps);
anewn = sim(net,pnewn);
anew = mapstd('reverse',anewn,ts);
```

For most networks, including `feedforwardnet`, these steps are done automatically, so that you only need to use the `sim` command.

## Algorithms

It is assumed that  $X$  has only finite real values, and that the elements of each row are not all equal.

$$y = (x - x_{\text{mean}}) * (y_{\text{std}} / x_{\text{std}}) + y_{\text{mean}};$$

## See Also

`fixunknowns` | `mapminmax` | `processpca`

**Introduced in R2006a**

## maxlinlr

Maximum learning rate for linear layer

### Syntax

```
lr = maxlinlr(P)  
lr = maxlinlr(P,'bias')
```

### Description

maxlinlr is used to calculate learning rates for `linearlayer`.

lr = maxlinlr(P) takes one argument,

P	R-by-Q matrix of input vectors
---	--------------------------------

and returns the maximum learning rate for a linear layer without a bias that is to be trained only on the vectors in P.

lr = maxlinlr(P,'bias') returns the maximum learning rate for a linear layer with a bias.

### Examples

Here you define a batch of four two-element input vectors and find the maximum learning rate for a linear layer with a bias.

```
P = [1 2 -4 7; 0.1 3 10 6];  
lr = maxlinlr(P,'bias')
```

### See Also

learnwh | linearlayer

**Introduced before R2006a**

## meanabs

Mean of absolute elements of matrix or matrices

### Syntax

```
[m,n] = meanabs(x)
```

### Description

[m,n] = meanabs(x) takes a matrix or cell array of matrices and returns,

m	Mean value of all absolute finite values
n	Number of finite values

If x contains no finite values, the mean returned is 0.

### Examples

```
m = meanabs([1 2;3 4])  
[m,n] = meanabs({[1 2; NaN 4], [4 5; 2 3]})
```

### See Also

meansqr | sumabs | sumsqr

**Introduced in R2010b**

## meansqr

Mean of squared elements of matrix or matrices

### Syntax

```
[m,n] = meansqr(x)
```

### Description

[m,n] = meansqr(x) takes a matrix or cell array of matrices and returns,

m	Mean value of all squared finite values
n	Number of finite values

If x contains no finite values, the mean returned is 0.

### Examples

```
m = meansqr([1 2;3 4])  
[m,n] = meansqr({[1 2; NaN 4], [4 5; 2 3]})
```

### See Also

meanabs | sumabs | sumsqr

**Introduced in R2010b**

# midpoint

Midpoint weight initialization function

## Syntax

```
W = midpoint(S,PR)
```

## Description

midpoint is a weight initialization function that sets weight (row) vectors to the center of the input ranges.

`W = midpoint(S,PR)` takes two arguments,

S	Number of rows (neurons)
PR	R-by-Q matrix of input value ranges = [Pmin Pmax]

and returns an S-by-R matrix with rows set to  $(P_{min}+P_{max})' / 2$ .

## Examples

Here initial weight values are calculated for a five-neuron layer with input elements ranging over [0 1] and [-2 2].

```
W = midpoint(5,[0 1; -2 2])
```

## See Also

[init](#) | [initlay](#) | [initwb](#)

**Introduced before R2006a**

## minmax

Ranges of matrix rows

### Syntax

```
pr = minmax(P)
```

### Description

`pr = minmax(P)` takes one argument,

P	R-by-Q matrix
---	---------------

and returns the R-by-2 matrix `pr` of minimum and maximum values for each row of `P`.

Alternatively, `P` can be an M-by-N cell array of matrices. Each matrix `P{i, j}` should have `Ri` rows and `Q` columns. In this case, `minmax` returns an M-by-1 cell array where the `m`th element is an `Ri`-by-2 matrix of the minimum and maximum values of elements for the matrix on the `i`th row of `P`.

### Examples

```
x = rands(4,5)
mm = minmax(x)
x = nndata([1;2],3,4)
mm = minmax(x)
```

**Introduced before R2006a**

## mse

Mean squared normalized error performance function

### Syntax

```
perf = mse(net,t,y,ew)
```

### Description

`mse` is a network performance function. It measures the network's performance according to the mean of squared errors.

`perf = mse(net,t,y,ew)` takes these arguments:

<code>net</code>	Neural network
<code>t</code>	Matrix or cell array of targets
<code>y</code>	Matrix or cell array of outputs
<code>ew</code>	Error weights (optional)

and returns the mean squared error.

This function has two optional parameters, which are associated with networks whose `net.trainFcn` is set to this function:

- `'regularization'` can be set to any value between 0 and 1. The greater the regularization value, the more squared weights and biases are included in the performance calculation relative to errors. The default is 0, corresponding to no regularization.
- `'normalization'` can be set to `'none'` (the default); `'standard'`, which normalizes errors between -2 and 2, corresponding to normalizing outputs and targets between -1 and 1; and `'percent'`, which normalizes errors between -1 and 1. This feature is useful for networks with multi-element outputs. It ensures that the relative accuracy of output elements with differing target value ranges are treated as equally important, instead of prioritizing the relative accuracy of the output element with the largest target value range.

You can create a standard network that uses `mse` with `feedforwardnet` or `cascadeforwardnet`. To prepare a custom network to be trained with `mse`, set `net.performFcn` to `'mse'`. This automatically sets `net.performParam` to a structure with the default optional parameter values.

## Examples

### Train Neural Network Using mse Performance Function

This example shows how to train a neural network using the `mse` performance function.

Here a two-layer feedforward network is created and trained to estimate body fat percentage using the `mse` performance function and a regularization value of 0.01.

```
[x, t] = bodyfat_dataset;  
net = feedforwardnet(10);  
net.performParam.regularization = 0.01;
```

MSE is the default performance function for `feedforwardnet`.

```
net.performFcn
```

```
ans =  
'mse'
```

Train the network and evaluate performance.

```
net = train(net, x, t);  
y = net(x);  
perf = perform(net, t, y)
```

```
perf = 20.7769
```

Alternatively, you can call `mse` directly.

```
perf = mse(net, t, y, 'regularization', 0.01)
```

```
perf = 20.7769
```

### See Also

`mae`

**Introduced before R2006a**



# narnet

Nonlinear autoregressive neural network

## Syntax

```
narnet(feedbackDelays,hiddenSizes,feedbackMode,trainFcn)
```

## Description

NAR (nonlinear autoregressive) neural networks can be trained to predict a time series from that series past values.

`narnet(feedbackDelays,hiddenSizes,feedbackMode,trainFcn)` takes these arguments,

<code>feedbackDelays</code>	Row vector of increasing 0 or positive delays (default = 1:2)
<code>hiddenSizes</code>	Row vector of one or more hidden layer sizes (default = 10)
<code>feedbackMode</code>	One of 'open', 'closed', or 'none' (default is 'open')
<code>trainFcn</code>	Training function (default is 'trainlm')

and returns a NAR neural network.

## Examples

### Train NAR Network and Predict on New Data

Load the simple time-series prediction data and create a NAR network.

```
T = simplenar_dataset;
net = narnet(1:2,10);
```

Prepare the time series data using `preparets` and train the network.

```
[Xs,Xi,Ai,Ts] = preparets(net,{}, {},T);
net = train(net,Xs,Ts,Xi,Ai);
view(net)
```

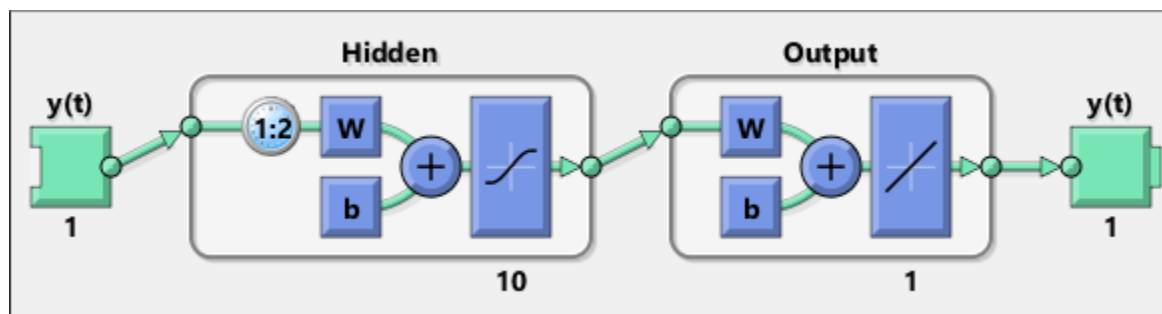

Calculate the network performance.

```
[Y,Xf,Af] = net(Xs,Xi,Ai);
perf = perform(net,Ts,Y)
```

```
perf =
    1.0100e-09
```

To predict the output for the next 20 time steps, first simulate the network in closed loop form.

```
[netc,Xic,Aic] = closeloop(net,Xf,Af);
view(netc)
```

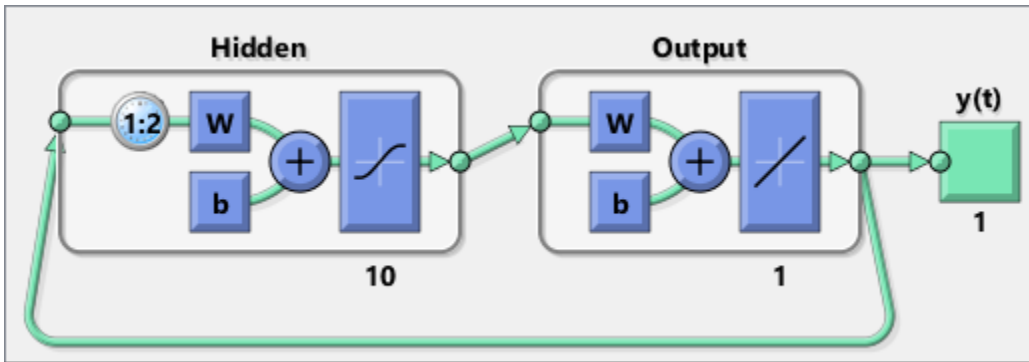

The network only has one input. In closed loop mode, this input is joined to the output.

To simulate the network 20 time steps ahead, input an empty cell array of length 20. The network requires only the initial conditions given in `Xic` and `Aic`.

```
y2 = netc(cell(0,20),Xic,Aic)
```

```
y2 =
    1x20 cell array
    Columns 1 through 5
        {[0.8346]}    {[0.3329]}    {[0.9084]}    {[1.0000]}    {[0.3190]}
    Columns 6 through 10
        {[0.7329]}    {[0.9801]}    {[0.6409]}    {[0.5146]}    {[0.9746]}
    Columns 11 through 15
        {[0.9077]}    {[0.2807]}    {[0.8651]}    {[0.9897]}    {[0.4093]}
    Columns 16 through 20
```

{[0.6838]}   {[0.9976]}   {[0.7007]}   {[0.4311]}   {[0.9660]}

**See Also**

narnet | narxnet | preparets | removedelay | timedelaynet

**Introduced in R2010b**

## narxnet

Nonlinear autoregressive neural network with external input

### Syntax

```
narxnet(inputDelays, feedbackDelays, hiddenSizes, feedbackMode, trainFcn)
```

### Description

NARX (Nonlinear autoregressive with external input) networks can learn to predict one time series given past values of the same time series, the feedback input, and another time series, called the external or exogenous time series.

`narxnet(inputDelays, feedbackDelays, hiddenSizes, feedbackMode, trainFcn)` takes these arguments,

<code>inputDelays</code>	Row vector of increasing 0 or positive delays (default = 1:2)
<code>feedbackDelays</code>	Row vector of increasing 0 or positive delays (default = 1:2)
<code>hiddenSizes</code>	Row vector of one or more hidden layer sizes (default = 10)
<code>feedbackMode</code>	One of 'open', 'closed', or 'none' (default is 'open')
<code>trainFcn</code>	Training function (default is 'trainlm')

and returns a NARX neural network.

### Examples

#### Train NARX Network and Predict on New Data

Partition the training data. Use `Xnew` to do prediction in closed loop mode later.

```
[X,T] = simpleseries_dataset;  
Xnew = X(81:100);  
X = X(1:80);  
T = T(1:80);
```

Train a network, and simulate it on the first 80 observations

```
net = narxnet(1:2,1:2,10);  
[Xs,Xi,Ai,Ts] = preparets(net,X,{},T);  
net = train(net,Xs,Ts,Xi,Ai);  
view(net)
```

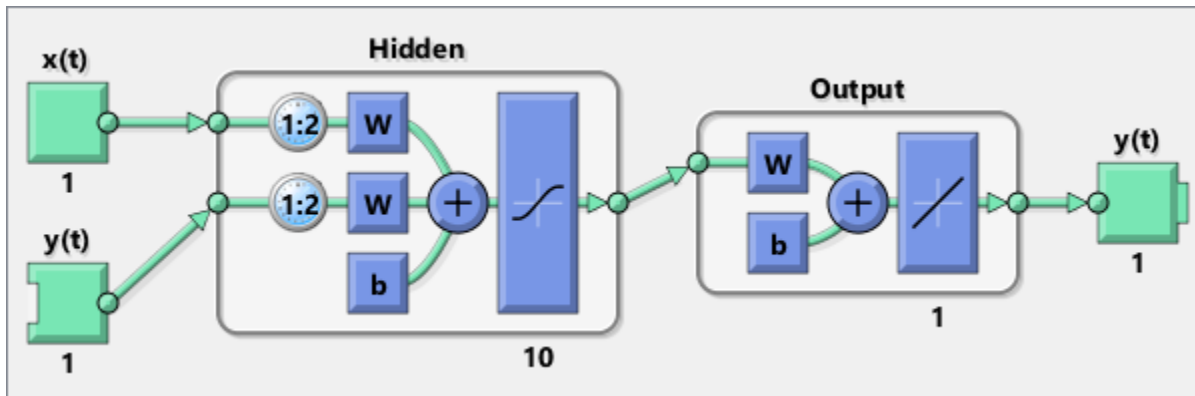

Calculate the network performance.

```
[Y,Xf,Af] = net(Xs,Xi,Ai);
perf = perform(net,Ts,Y)
```

perf =

0.0153

Run the prediction for 20 time steps ahead in closed loop mode.

```
[netc,Xic,Aic] = closeloop(net,Xf,Af);
view(netc)
```

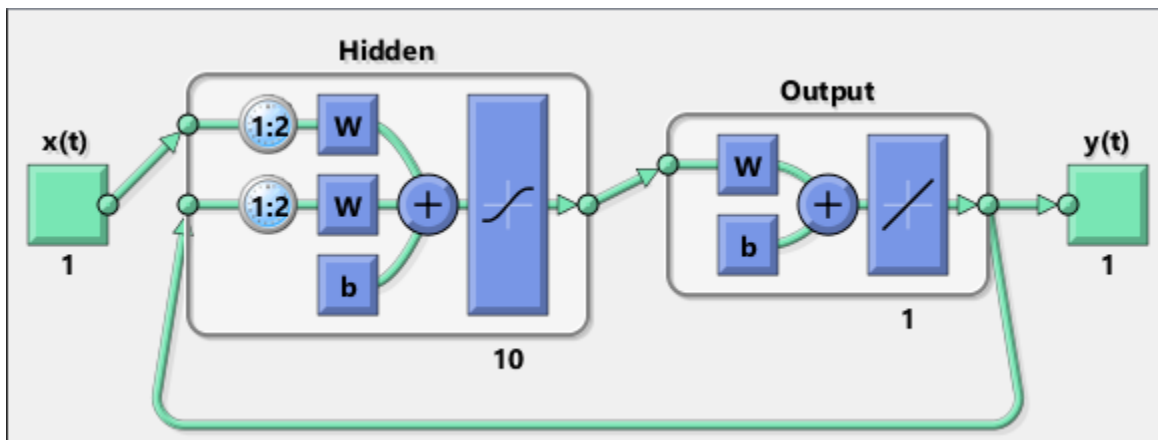

```
y2 = netc(Xnew,Xic,Aic)
```

y2 =

1x20 cell array

Columns 1 through 5

```
{[-0.0156]}  {[0.1133]}  {[ -0.1472]}  {[ -0.0706]}  {[0.0355]}
```

Columns 6 through 10

{[-0.2829]} { [0.2047]} {[-0.3809]} {[-0.2836]} {[0.1886]}

Columns 11 through 15

{[-0.1813]} {[0.1373]} {[0.2189]} {[0.3122]} {[0.2346]}

Columns 16 through 20

{[-0.0156]} {[0.0724]} {[0.3395]} {[0.1940]} {[0.0757]}

### See Also

[closeloop](#) | [narnet](#) | [openloop](#) | [preparets](#) | [removedelay](#) | [timedelaynet](#)

**Introduced in R2010b**

# nctool

Neural network classification or clustering tool

## Syntax

```
nctool
```

## Description

nctool opens the Neural Net Clustering GUI.

For more information and an example of its usage, see “Cluster Data with a Self-Organizing Map”.

## Algorithms

nctool leads you through solving a clustering problem using a self-organizing map. The map forms a compressed representation of the inputs space, reflecting both the relative density of input vectors in that space, and a two-dimensional compressed representation of the input-space topology.

## See Also

nftool | nprtool | ntstool

**Introduced in R2008a**

## negdist

Negative distance weight function

### Syntax

```
Z = negdist(W,P)
dim = negdist('size',S,R,FP)
dw = negdist('dz_dw',W,P,Z,FP)
```

### Description

`negdist` is a weight function. Weight functions apply weights to an input to get weighted inputs.

`Z = negdist(W,P)` takes these inputs,

W	S-by-R weight matrix
P	R-by-Q matrix of Q input (column) vectors
FP	Row cell array of function parameters (optional, ignored)

and returns the S-by-Q matrix of negative vector distances.

`dim = negdist('size',S,R,FP)` takes the layer dimension S, input dimension R, and function parameters, and returns the weight size [S-by-R].

`dw = negdist('dz_dw',W,P,Z,FP)` returns the derivative of Z with respect to W.

### Examples

Here you define a random weight matrix W and input vector P and calculate the corresponding weighted input Z.

```
W = rand(4,3);
P = rand(3,1);
Z = negdist(W,P)
```

### Network Use

You can create a standard network that uses `negdist` by calling `competlayer` or `selforgmap`.

To change a network so an input weight uses `negdist`, set `net.inputWeights{i,j}.weightFcn` to 'negdist'. For a layer weight, set `net.layerWeights{i,j}.weightFcn` to 'negdist'.

In either case, call `sim` to simulate the network with `negdist`.

### Algorithms

`negdist` returns the negative Euclidean distance:

$$z = -\sqrt{\sum(w-p)^2}$$



**See Also**

competlayer | dist | dotprod | selforgmap | sim

**Introduced before R2006a**

## netinv

Inverse transfer function

### Syntax

```
A = netinv(N,FP)
```

### Description

`netinv` is a transfer function. Transfer functions calculate a layer's output from its net input.

`A = netinv(N,FP)` takes inputs

N	S-by-Q matrix of net input (column) vectors
FP	Struct of function parameters (ignored)

and returns  $1/N$ .

`info = netinv('code')` returns information about this function. The following codes are supported:

`netinv('name')` returns the name of this function.

`netinv('output',FP)` returns the [min max] output range.

`netinv('active',FP)` returns the [min max] active input range.

`netinv('fullderiv')` returns 1 or 0, depending on whether  $dA_{dN}$  is S-by-S-by-Q or S-by-Q.

`netinv('fpnames')` returns the names of the function parameters.

`netinv('fpdefaults')` returns the default function parameters.

### Examples

Here you define 10 five-element net input vectors `N` and calculate `A`.

```
n = rand(5,10);  
a = netinv(n);
```

Assign this transfer function to layer `i` of a network.

```
net.layers{i}.transferFcn = 'netinv';
```

### See Also

`logsig` | `tansig`

**Introduced in R2006a**

# netprod

Product net input function

## Syntax

```
N = netprod({Z1,Z2,...,Zn})
info = netprod('code')
```

## Description

netprod is a net input function. Net input functions calculate a layer's net input by combining its weighted inputs and biases.

`N = netprod({Z1,Z2,...,Zn})` takes

$Z_i$	S-by-Q matrices in a row cell array
-------	-------------------------------------

and returns an element-wise product of  $Z_1$  to  $Z_n$ .

`info = netprod('code')` returns information about this function. The following codes are supported:

'deriv'	Name of derivative function
'fullderiv'	Full N-by-S-by-Q derivative = 1, element-wise S-by-Q derivative = 0
'name'	Full name
'fpnames'	Returns names of function parameters
'fpdefaults'	Returns default function parameters

## Examples

Here netprod combines two sets of weighted input vectors (user-defined).

```
Z1 = [1 2 4;3 4 1];
Z2 = [-1 2 2; -5 -6 1];
Z = {Z1,Z2};
N = netprod({Z})
```

Here netprod combines the same weighted inputs with a bias vector. Because  $Z_1$  and  $Z_2$  each contain three concurrent vectors, three concurrent copies of  $B$  must be created with `concur` so that all sizes match.

```
B = [0; -1];
Z = {Z1, Z2, concur(B,3)};
N = netprod(Z)
```

## **Network Use**

You can create a standard network that uses `netprod` by calling `newpnn` or `newgrnn`.

To change a network so that a layer uses `netprod`, set `net.layers{i}.netInputFcn` to `'netprod'`.

In either case, call `sim` to simulate the network with `netprod`. See `newpnn` or `newgrnn` for simulation examples.

## **See Also**

`concur` | `netsum` | `sim`

**Introduced before R2006a**

# netsum

Sum net input function

## Syntax

```
N = netsum({Z1,Z2,...,Zn},FP)
info = netsum('code')
```

## Description

`netsum` is a net input function. Net input functions calculate a layer's net input by combining its weighted inputs and biases.

`N = netsum({Z1,Z2,...,Zn},FP)` takes `Z1` to `Zn` and optional function parameters,

<code>Zi</code>	S-by-Q matrices in a row cell array
<code>FP</code>	Row cell array of function parameters (ignored)

and returns the elementwise sum of `Z1` to `Zn`.

`info = netsum('code')` returns information about this function. The following codes are supported:

`netsum('name')` returns the name of this function.

`netsum('type')` returns the type of this function.

`netsum('fpnames')` returns the names of the function parameters.

`netsum('fpdefaults')` returns default function parameter values.

`netsum('fpcheck', FP)` throws an error for illegal function parameters.

`netsum('fullderiv')` returns 0 or 1, depending on whether the derivative is S-by-Q or N-by-S-by-Q.

## Examples

Here `netsum` combines two sets of weighted input vectors and a bias. You must use `concur` to make `b` the same dimensions as `z1` and `z2`.

```
z1 = [1, 2, 4; 3, 4, 1]
z2 = [-1, 2, 2; -5, -6, 1]
b = [0; -1]
n = netsum({z1, z2, concur(b, 3)})
```

Assign this net input function to the first layer of a network.

```
net = feedforwardnet();
net.layers{1}.netInputFcn = 'netsum';
```

**See Also**

`cascadeforwardnet` | `feedforwardnet` | `netinv` | `netprod`

**Introduced before R2006a**

# network

Create custom shallow neural network

## Syntax

```
net = network
net =
network(numInputs,numLayers,biasConnect,inputConnect,layerConnect,outputConnect)
```

## To Get Help

Type `help network/network`.

---

**Tip** To learn how to create a deep learning network, see “Specify Layers of Convolutional Neural Network”.

---

## Description

`network` creates new custom networks. It is used to create networks that are then customized by functions such as `feedforwardnet` and `narxnet`.

`net = network` without arguments returns a new neural network with no inputs, layers or outputs.

`net = network(numInputs,numLayers,biasConnect,inputConnect,layerConnect,outputConnect)` takes these optional arguments (shown with default values):

<code>numInputs</code>	Number of inputs, 0
<code>numLayers</code>	Number of layers, 0
<code>biasConnect</code>	<code>numLayers-by-1</code> Boolean vector, zeros
<code>inputConnect</code>	<code>numLayers-by-numInputs</code> Boolean matrix, zeros
<code>layerConnect</code>	<code>numLayers-by-numLayers</code> Boolean matrix, zeros
<code>outputConnect</code>	<code>1-by-numLayers</code> Boolean vector, zeros

and returns

<code>net</code>	New network with the given property values
------------------	--

## Properties

### Architecture Properties

<code>net.numInputs</code>	0 or a positive integer	Number of inputs.
----------------------------	-------------------------	-------------------

<code>net.numLayers</code>	0 or a positive integer	Number of layers.
<code>net.biasConnect</code>	<code>numLayer</code> -by-1 Boolean vector	If <code>net.biasConnect(i)</code> is 1, then layer <code>i</code> has a bias, and <code>net.biases{i}</code> is a structure describing that bias.
<code>net.inputConnect</code>	<code>numLayer</code> -by- <code>numInputs</code> Boolean vector	If <code>net.inputConnect(i, j)</code> is 1, then layer <code>i</code> has a weight coming from input <code>j</code> , and <code>net.inputWeights{i, j}</code> is a structure describing that weight.
<code>net.layerConnect</code>	<code>numLayer</code> -by- <code>numLayers</code> Boolean vector	If <code>net.layerConnect(i, j)</code> is 1, then layer <code>i</code> has a weight coming from layer <code>j</code> , and <code>net.layerWeights{i, j}</code> is a structure describing that weight.
<code>net.outputConnect</code>	1-by- <code>numLayers</code> Boolean vector	If <code>net.outputConnect(i)</code> is 1, then the network has an output from layer <code>i</code> , and <code>net.outputs{i}</code> is a structure describing that output.
<code>net.numOutputs</code>	0 or a positive integer (read only)	Number of network outputs according to <code>net.outputConnect</code> .
<code>net.numInputDelays</code>	0 or a positive integer (read only)	Maximum input delay according to all <code>net.inputWeights{i, j}.delays</code> .
<code>net.numLayerDelays</code>	0 or a positive number (read only)	Maximum layer delay according to all <code>net.layerWeights{i, j}.delays</code> .

**Subject Structure Properties**

<code>net.inputs</code>	<code>numInputs</code> -by-1 cell array	<code>net.inputs{i}</code> is a structure defining input <code>i</code> .
<code>net.layers</code>	<code>numLayers</code> -by-1 cell array	<code>net.layers{i}</code> is a structure defining layer <code>i</code> .
<code>net.biases</code>	<code>numLayers</code> -by-1 cell array	If <code>net.biasConnect(i)</code> is 1, then <code>net.biases{i}</code> is a structure defining the bias for layer <code>i</code> .
<code>net.inputWeights</code>	<code>numLayers</code> -by- <code>numInputs</code> cell array	If <code>net.inputConnect(i, j)</code> is 1, then <code>net.inputWeights{i, j}</code> is a structure defining the weight to layer <code>i</code> from input <code>j</code> .
<code>net.layerWeights</code>	<code>numLayers</code> -by- <code>numLayers</code> cell array	If <code>net.layerConnect(i, j)</code> is 1, then <code>net.layerWeights{i, j}</code> is a structure defining the weight to layer <code>i</code> from layer <code>j</code> .
<code>net.outputs</code>	1-by- <code>numLayers</code> cell array	If <code>net.outputConnect(i)</code> is 1, then <code>net.outputs{i}</code> is a structure defining the network output from layer <code>i</code> .

**Function Properties**

<code>net.adaptFcn</code>	Name of a network adaption function or ''
<code>net.initFcn</code>	Name of a network initialization function or ''



<code>net.performFcn</code>	Name of a network performance function or ''
<code>net.trainFcn</code>	Name of a network training function or ''

### Parameter Properties

<code>net.adaptParam</code>	Network adaption parameters
<code>net.initParam</code>	Network initialization parameters
<code>net.performParam</code>	Network performance parameters
<code>net.trainParam</code>	Network training parameters

### Weight and Bias Value Properties

<code>net.IW</code>	<code>numLayers-by-numInputs</code> cell array of input weight values
<code>net.LW</code>	<code>numLayers-by-numLayers</code> cell array of layer weight values
<code>net.b</code>	<code>numLayers-by-1</code> cell array of bias values

### Other Properties

<code>net.userdata</code>	Structure you can use to store useful values
---------------------------	--

## Examples

### Create Network with One Input and Two Layers

This example shows how to create a network without any inputs and layers, and then set its numbers of inputs and layers to 1 and 2 respectively.

```
net = network
net.numInputs = 1
net.numLayers = 2
```

Alternatively, you can create the same network with one line of code.

```
net = network(1,2)
```

### Create Feedforward Network and View Properties

This example shows how to create a one-input, two-layer, feedforward network. Only the first layer has a bias. An input weight connects to layer 1 from input 1. A layer weight connects to layer 2 from layer 1. Layer 2 is a network output and has a target.

```
net = network(1,2,[1;0],[1; 0],[0 0; 1 0],[0 1])
```

You can view the network subobjects with the following code.

```
net.inputs{1}
net.layers{1}, net.layers{2}
net.biases{1}
net.inputWeights{1,1}, net.layerWeights{2,1}
net.outputs{2}
```

You can alter the properties of any of the network subobjects. This code changes the transfer functions of both layers:

```
net.layers{1}.transferFcn = 'tansig';  
net.layers{2}.transferFcn = 'logsig';
```

You can view the weights for the connection from the first input to the first layer as follows. The weights for a connection from an input to a layer are stored in `net.IW`. If the values are not yet set, the result is empty.

```
net.IW{1,1}
```

You can view the weights for the connection from the first layer to the second layer as follows. Weights for a connection from a layer to a layer are stored in `net.LW`. Again, if the values are not yet set, the result is empty.

```
net.LW{2,1}
```

You can view the bias values for the first layer as follows.

```
net.b{1}
```

To change the number of elements in input 1 to 2, set each element's range:

```
net.inputs{1}.range = [0 1; -1 1];
```

To simulate the network for a two-element input vector, the code might look like this:

```
p = [0.5; -0.1];  
y = sim(net,p)
```

### See Also

`sim`

### Topics

"Neural Network Object Properties"

"Neural Network Subobject Properties"

**Introduced before R2006a**

## newgrnn

Design generalized regression neural network

### Syntax

```
net = newgrnn(P,T,spread)
```

### Description

Generalized regression neural networks (grnns) are a kind of radial basis network that is often used for function approximation. grnns can be designed very quickly.

`net = newgrnn(P,T,spread)` takes three inputs,

P	R-by-Q matrix of Q input vectors
T	S-by-Q matrix of Q target class vectors
spread	Spread of radial basis functions (default = 1.0)

and returns a new generalized regression neural network.

The larger the `spread`, the smoother the function approximation. To fit data very closely, use a `spread` smaller than the typical distance between input vectors. To fit the data more smoothly, use a larger `spread`.

### Properties

`newgrnn` creates a two-layer network. The first layer has `radbas` neurons, and calculates weighted inputs with `dist` and net input with `netprod`. The second layer has `purelin` neurons, calculates weighted input with `normprod`, and net inputs with `netsum`. Only the first layer has biases.

`newgrnn` sets the first layer weights to  $P'$ , and the first layer biases are all set to  $0.8326/\text{spread}$ , resulting in radial basis functions that cross 0.5 at weighted inputs of  $\pm \text{spread}$ . The second layer weights  $W2$  are set to  $T$ .

### Examples

Here you design a radial basis network, given inputs  $P$  and targets  $T$ .

```
P = [1 2 3];
T = [2.0 4.1 5.9];
net = newgrnn(P,T);
```

The network is simulated for a new input.

```
P = 1.5;
Y = sim(net,P)
```

## **References**

Wasserman, P.D., *Advanced Methods in Neural Computing*, New York, Van Nostrand Reinhold, 1993, pp. 155-61

## **See Also**

newpnn | newrb | newrbe | sim

**Introduced before R2006a**

# newlind

Design linear layer

## Syntax

```
net = newlind(P,T,Pi)
```

## Description

`net = newlind(P,T,Pi)` takes these input arguments,

P	R-by-Q matrix of Q input vectors
T	S-by-Q matrix of Q target class vectors
Pi	1-by-ID cell array of initial input delay states

where each element  $P_{i,k}$  is an  $R_i$ -by- $Q$  matrix, and the default = `[]`; and returns a linear layer designed to output T (with minimum sum square error) given input P.

`newlind(P,T,Pi)` can also solve for linear networks with input delays and multiple inputs and layers by supplying input and target data in cell array form:

P	$N_i$ -by-TS cell array	Each element $P_{i,ts}$ is an $R_i$ -by- $Q$ input matrix
T	$N_t$ -by-TS cell array	Each element $T_{i,ts}$ is a $V_i$ -by- $Q$ matrix
Pi	$N_i$ -by-ID cell array	Each element $P_{i,k}$ is an $R_i$ -by- $Q$ matrix, default = <code>[]</code>

and returns a linear network with ID input delays,  $N_i$  network inputs, and  $N_l$  layers, designed to output T (with minimum sum square error) given input P.

## Examples

You want a linear layer that outputs T given P for the following definitions:

```
P = [1 2 3];
T = [2.0 4.1 5.9];
```

Use `newlind` to design such a network and check its response.

```
net = newlind(P,T);
Y = sim(net,P)
```

You want another linear layer that outputs the sequence T given the sequence P and two initial input delay states Pi.

```
P = {1 2 1 3 3 2};
Pi = {1 3};
T = {5.0 6.1 4.0 6.0 6.9 8.0};
net = newlind(P,T,Pi);
Y = sim(net,P,Pi)
```

You want a linear network with two outputs Y1 and Y2 that generate sequences T1 and T2, given the sequences P1 and P2, with three initial input delay states Pi1 for input 1 and three initial delays states Pi2 for input 2.

```
P1 = {1 2 1 3 3 2}; Pi1 = {1 3 0};  
P2 = {1 2 1 1 2 1}; Pi2 = {2 1 2};  
T1 = {5.0 6.1 4.0 6.0 6.9 8.0};  
T2 = {11.0 12.1 10.1 10.9 13.0 13.0};  
net = newlind([P1; P2],[T1; T2],[Pi1; Pi2]);  
Y = sim(net,[P1; P2],[Pi1; Pi2]);  
Y1 = Y(1,:)  
Y2 = Y(2, :)
```

## Algorithms

`newlind` calculates weight *W* and bias *B* values for a linear layer from inputs *P* and targets *T* by solving this linear equation in the least squares sense:

$$[W \ b] * [P; \text{ones}] = T$$

## See Also

`sim`

**Introduced before R2006a**

## newpnn

Design probabilistic neural network

### Syntax

```
net = newpnn(P,T,spread)
```

### Description

Probabilistic neural networks (PNN) are a kind of radial basis network suitable for classification problems.

`net = newpnn(P,T,spread)` takes two or three arguments,

P	R-by-Q matrix of Q input vectors
T	S-by-Q matrix of Q target class vectors
spread	Spread of radial basis functions (default = 0.1)

and returns a new probabilistic neural network.

If `spread` is near zero, the network acts as a nearest neighbor classifier. As `spread` becomes larger, the designed network takes into account several nearby design vectors.

### Examples

Here a classification problem is defined with a set of inputs P and class indices Tc.

```
P = [1 2 3 4 5 6 7];
Tc = [1 2 3 2 2 3 1];
```

The class indices are converted to target vectors, and a PNN is designed and tested.

```
T = ind2vec(Tc)
net = newpnn(P,T);
Y = sim(net,P)
Yc = vec2ind(Y)
```

### Algorithms

`newpnn` creates a two-layer network. The first layer has `radbas` neurons, and calculates its weighted inputs with `dist` and its net input with `netprod`. The second layer has `compet` neurons, and calculates its weighted input with `dotprod` and its net inputs with `netsum`. Only the first layer has biases.

`newpnn` sets the first-layer weights to  $P'$ , and the first-layer biases are all set to  $0.8326/\text{spread}$ , resulting in radial basis functions that cross 0.5 at weighted inputs of  $\pm \text{spread}$ . The second-layer weights  $W2$  are set to T.

## References

Wasserman, P.D., *Advanced Methods in Neural Computing*, New York, Van Nostrand Reinhold, 1993, pp. 35-55

## See Also

ind2vec | newgrnn | newrb | newrbe | sim | vec2ind

**Introduced before R2006a**



## newrb

Design radial basis network

### Syntax

```
net = newrb(P,T,goal,spread,MN,DF)
```

### Description

Radial basis networks can be used to approximate functions. `newrb` adds neurons to the hidden layer of a radial basis network until it meets the specified mean squared error goal.

`net = newrb(P,T,goal,spread,MN,DF)` takes two of these arguments,

P	R-by-Q matrix of Q input vectors
T	S-by-Q matrix of Q target class vectors
goal	Mean squared error goal (default = 0.0)
spread	Spread of radial basis functions (default = 1.0)
MN	Maximum number of neurons (default is Q)
DF	Number of neurons to add between displays (default = 25)

and returns a new radial basis network.

The larger `spread` is, the smoother the function approximation. Too large a spread means a lot of neurons are required to fit a fast-changing function. Too small a spread means many neurons are required to fit a smooth function, and the network might not generalize well. Call `newrb` with different spreads to find the best value for a given problem.

### Examples

Here you design a radial basis network, given inputs P and targets T.

```
P = [1 2 3];
T = [2.0 4.1 5.9];
net = newrb(P,T);
```

The network is simulated for a new input.

```
P = 1.5;
Y = sim(net,P)
```

### Algorithms

`newrb` creates a two-layer network. The first layer has `rdbas` neurons, and calculates its weighted inputs with `dist` and its net input with `netprod`. The second layer has `purelin` neurons, and calculates its weighted input with `dotprod` and its net inputs with `netsum`. Both layers have biases.

Initially the `raddbas` layer has no neurons. The following steps are repeated until the network's mean squared error falls below `goal`.

- 1 The network is simulated.
- 2 The input vector with the greatest error is found.
- 3 A `raddbas` neuron is added with weights equal to that vector.
- 4 The `purelin` layer weights are redesigned to minimize error.

### **See Also**

`newgrnn` | `newpnn` | `newrbe` | `sim`

**Introduced before R2006a**

## newrbe

Design exact radial basis network

### Syntax

```
net = newrbe(P,T,spread)
```

### Description

Radial basis networks can be used to approximate functions. `newrbe` very quickly designs a radial basis network with zero error on the design vectors.

`net = newrbe(P,T,spread)` takes two or three arguments,

P	RxQ matrix of Q R-element input vectors
T	SxQ matrix of Q S-element target class vectors
spread	Spread of radial basis functions (default = 1.0)

and returns a new exact radial basis network.

The larger the `spread` is, the smoother the function approximation will be. Too large a spread can cause numerical problems.

### Examples

Here you design a radial basis network given inputs P and targets T.

```
P = [1 2 3];
T = [2.0 4.1 5.9];
net = newrbe(P,T);
```

The network is simulated for a new input.

```
P = 1.5;
Y = sim(net,P)
```

### Algorithms

`newrbe` creates a two-layer network. The first layer has `rdbas` neurons, and calculates its weighted inputs with `dist` and its net input with `netprod`. The second layer has `purelin` neurons, and calculates its weighted input with `dotprod` and its net inputs with `netsum`. Both layers have biases.

`newrbe` sets the first-layer weights to  $P'$ , and the first-layer biases are all set to  $0.8326/\text{spread}$ , resulting in radial basis functions that cross 0.5 at weighted inputs of  $\pm \text{spread}$ .

The second-layer weights  $IW\{2,1\}$  and biases  $b\{2\}$  are found by simulating the first-layer outputs  $A\{1\}$  and then solving the following linear expression:

$$[W\{2,1\} \ b\{2\}] * [A\{1\}; \text{ones}] = T$$

**See Also**

`newgrnn` | `newpnn` | `newrb` | `sim`

**Introduced before R2006a**

# nftool

Neural Net Fitting tool

## Syntax

nftool

## Description

nftool opens the Neural Net Fitting GUI.

For more information and an example of its usage, see “Fit Data with a Shallow Neural Network”.

## Algorithms

nftool leads you through solving a data fitting problem, solving it with a two-layer feed-forward network trained with Levenberg-Marquardt.

## See Also

nctool | nprtool | ntstool

**Introduced in R2006a**

## nncell2mat

Combine neural network cell data into matrix

### Syntax

```
[y,i,j] nncell2mat(x)
```

### Description

[y,i,j] nncell2mat(x) takes a cell array of matrices and returns,

y	Cell array formed by concatenating matrices
i	Array of row sizes
ji	Array of column sizes

The row and column sizes returned by nncell2mat can be used to convert the returned matrix back into a cell of matrices with mat2cell.

### Examples

Here neural network data is converted to a matrix and back.

```
c = {rands(2,3) rands(2,3); rands(5,3) rands(5,3)};
[m,i,j] = nncell2mat(c)
c3 = mat2cell(m,i,j)
```

### See Also

nndata | nnsz

**Introduced in R2010b**

## nncorr

Cross correlation between neural network time series

### Syntax

```
nncorr(a,b,maxlag,'flag')
```

### Description

`nncorr(a,b,maxlag,'flag')` takes these arguments,

<code>a</code>	Matrix or cell array, with columns interpreted as timesteps, and having a total number of matrix rows of <code>N</code> .
<code>b</code>	Matrix or cell array, with columns interpreted as timesteps, and having a total number of matrix rows of <code>M</code> .
<code>maxlag</code>	Maximum number of time lags
<code>flag</code>	Type of normalization (default = 'none')

and returns an `N`-by-`M` cell array where each `{i,j}` element is a `2*maxlag+1` length row vector formed from the correlations of `a` elements (i.e., matrix row) `i` and `b` elements (i.e., matrix column) `j`.

If `a` and `b` are specified with row vectors, the result is returned in matrix form.

The options for the normalization `flag` are:

- 'biased' — scales the raw cross-correlation by  $1/N$ .
- 'unbiased' — scales the raw correlation by  $1/(N - \text{abs}(k))$ , where `k` is the index into the result.
- 'coeff' — normalizes the sequence so that the correlations at zero lag are 1.0.
- 'none' — no scaling. This is the default.

### Examples

Here the autocorrelation of a random 1-element, 1-sample, 20-timestep signal is calculated with a maximum lag of 10.

```
a = nndata(1,1,20)
aa = nncorr(a,a,10)
```

Here the cross-correlation of the first signal with another random 2-element signal are found, with a maximum lag of 8.

```
b = nndata(2,1,20)
ab = nncorr(a,b,8)
```

### See Also

[confusion](#) | [regression](#)

**Introduced in R2010b**



# nndata

Create neural network data

## Syntax

```
nndata(N,Q,TS,v)
```

## Description

`nndata(N,Q,TS,v)` takes these arguments,

N	Vector of M element sizes
Q	Number of samples
TS	Number of timesteps
v	Scalar value

and returns an M-by-TS cell array where each row *i* has N(*i*)-by-Q sized matrices of value *v*. If *v* is not specified, random values are returned.

You can access subsets of neural network data with `getelements`, `getsamples`, `gettimesteps`, and `getsignals`.

You can set subsets of neural network data with `setelements`, `setsamples`, `settimesteps`, and `setsignals`.

You can concatenate subsets of neural network data with `catelements`, `catsamples`, `cattimesteps`, and `catsignals`.

## Examples

Here four samples of five timesteps, for a 2-element signal consisting of zero values is created:

```
x = nndata(2,4,5,0)
```

To create random data with the same dimensions:

```
x = nndata(2,4,5)
```

Here static (1 timestep) data of 12 samples of 4 elements is created.

```
x = nndata(4,12)
```

## See Also

[fromnndata](#) | [nndata2sim](#) | [nnsim](#) | [sim2nndata](#) | [tonndata](#)

**Introduced in R2010b**

## nndata2gpu

Format neural data for efficient GPU training or simulation

### Syntax

```
nndata2gpu(x)
[Y,Q,N,TS] = nndata2gpu(X)
nndata2gpu(X,PRECISION)
```

### Description

nndata2gpu requires Parallel Computing Toolbox.

nndata2gpu(x) takes an N-by-Q matrix X of Q N-element column vectors, and returns it in a form for neural network training and simulation on the current GPU device.

The N-by-Q matrix becomes a QQ-by-N gpuArray where QQ is Q rounded up to the next multiple of 32. The extra rows (Q+1):QQ are filled with NaN values. The gpuArray has the same precision ('single' or 'double') as X.

[Y,Q,N,TS] = nndata2gpu(X) can also take an M-by-TS cell array of M signals over TS time steps. Each element of X{i,ts} should be an Ni-by-Q matrix of Q Ni-element vectors, representing the ith signal vector at time step ts, across all Q time series. In this case, the gpuArray Y returned is QQ-by-(sum(Ni)\*TS). Dimensions Ni, Q, and TS are also returned so they can be used with gpu2nndata to perform the reverse formatting.

nndata2gpu(X,PRECISION) specifies the default precision of the gpuArray, which can be 'double' or 'single'.

### Examples

Copy a matrix to the GPU and back:

```
x = rand(5,6)
[y,q] = nndata2gpu(x)
x2 = gpu2nndata(y,q)
```

Copy neural network cell array data, representing four time series, each consisting of five time steps of 2-element and 3-element signals:

```
x = nndata([2;3],4,5)
[y,q,n,ts] = nndata2gpu(x)
x2 = gpu2nndata(y,q,n,ts)
```

### See Also

gpu2nndata

**Introduced in R2012b**

## nndata2sim

Convert neural network data to Simulink time series

### Syntax

```
nndata2sim(x,i,q)
```

### Description

nndata2sim(x,i,q) takes these arguments,

x	Neural network data
i	Index of signal (default = 1)
q	Index of sample (default = 1)

and returns time series q of signal i as a Simulink time series structure.

### Examples

Here random neural network data is created with two signals having 4 and 3 elements respectively, over 10 timesteps. Three such series are created.

```
x = nndata([4;3],3,10);
```

Now the second signal of the first series is converted to Simulink form.

```
y_2_1 = nndata2sim(x,2,1)
```

### See Also

nndata | nnsim | sim2nndata

**Introduced in R2010b**

## nnsiZe

Number of neural data elements, samples, timesteps, and signals

### Syntax

```
[N,Q,TS,M] = nnsiZe(X)
```

### Description

[N,Q,TS,M] = nnsiZe(X) takes neural network data *x* and returns,

N	Vector containing the number of element sizes for each of M signals
Q	Number of samples
TS	Number of timesteps
M	Number of signals

If *X* is a matrix, *N* is the number of rows of *X*, *Q* is the number of columns, and both *TS* and *M* are 1.

If *X* is a cell array, *N* is an *S*×1 vector, where *M* is the number of rows in *X*, and *N*(*i*) is the number of rows in *X*{*i*, 1}. *Q* is the number of columns in the matrices in *X*.

### Examples

This code gets the dimensions of matrix data:

```
x = [1 2 3; 4 7 4]
[n,q,ts,s] = nnsiZe(x)
```

This code gets the dimensions of cell array data:

```
x = {[1:3; 4:6] [7:9; 10:12]; [13:15] [16:18]}
[n,q,ts,s] = nnsiZe(x)
```

### See Also

[nndata](#) | [numelements](#) | [numsamples](#) | [numsignals](#) | [numtimesteps](#)

**Introduced in R2010b**

# nnstart

Neural network getting started GUI

## Syntax

nnstart

## Description

nnstart opens a window with launch buttons for neural network fitting, pattern recognition, clustering and time series tools. It also provides links to lists of data sets, examples, and other useful information for getting started. See specific topics on “Get Started with Deep Learning Toolbox”.

## See Also

nctool | nftool | nprtool | ntstool

**Introduced in R2010b**

## **nntool**

Open Network/Data Manager

### **Syntax**

nntool

### **Description**

nntool opens the Network/Data Manager window, which allows you to import, create, use, and export neural networks and data.

---

**Note** Although it is still available, nntool is no longer recommended. Instead, use nnstart, which provides graphical interfaces that allow you to design and deploy fitting, pattern recognition, clustering, and time-series neural networks.

---

### **See Also**

nnstart

**Introduced before R2006a**

# nntraintool

Neural network training tool

## Syntax

```
nntraintool  
nntraintool close  
nntraintool('close')
```

## Description

`nntraintool` opens the neural network training GUI.

This function can be called to make the training GUI visible before training has occurred, after training if the window has been closed, or just to bring the training GUI to the front.

Network training functions handle all activity within the training window.

To access additional useful plots, related to the current or last network trained, during or after training, click their respective buttons in the training window.

`nntraintool close` or `nntraintool('close')` closes the training window.

**Introduced in R2008a**

## noloop

Remove neural network open- and closed-loop feedback

### Syntax

```
net = noloop(net)
```

### Description

`net = noloop(net)` takes a neural network and returns the network with open- and closed-loop feedback removed.

For outputs `i`, where `net.outputs{i}.feedbackMode` is 'open', the feedback mode is set to 'none', `outputs{i}.feedbackInput` is set to the empty matrix, and the associated network input is deleted.

For outputs `i`, where `net.outputs{i}.feedbackMode` is 'closed', the feedback mode is set to 'none'.

### Examples

Here a NARX network is designed. The NARX network has a standard input and an open-loop feedback output to an associated feedback input.

```
[X,T] = simplenarx_dataset;  
net = narxnet(1:2,1:2,20);  
[Xs,Xi,Ai,Ts] = preparets(net,X,{},T);  
net = train(net,Xs,Ts,Xi,Ai);  
view(net)  
Y = net(Xs,Xi,Ai)
```

Now the network is converted to no loop form. The output and second input are no longer associated.

```
net = noloop(net);  
view(net)  
[Xs,Xi,Ai] = preparets(net,X,T);  
Y = net(Xs,Xi,Ai)
```

### See Also

`closeloop` | `openloop`

**Introduced in R2010b**



## normc

Normalize columns of matrix

### Syntax

```
normc(M)
```

### Description

normc(M) normalizes the columns of M to a length of 1.

### Examples

```
m = [1 2; 3 4];  
normc(m)  
ans =  
    0.3162    0.4472  
    0.9487    0.8944
```

### See Also

normr

**Introduced before R2006a**

## normprod

Normalized dot product weight function

### Syntax

```
Z = normprod(W,P,FP)
dim = normprod('size',S,R,FP)
dw = normprod('dz_dw',W,P,Z,FP)
```

### Description

normprod is a weight function. Weight functions apply weights to an input to get weighted inputs.

`Z = normprod(W,P,FP)` takes these inputs,

W	S-by-R weight matrix
P	R-by-Q matrix of Q input (column) vectors
FP	Row cell array of function parameters (optional, ignored)

and returns the S-by-Q matrix of normalized dot products.

`dim = normprod('size',S,R,FP)` takes the layer dimension S, input dimension R, and function parameters, and returns the weight size [S-by-R].

`dw = normprod('dz_dw',W,P,Z,FP)` returns the derivative of Z with respect to W.

### Examples

Here you define a random weight matrix W and input vector P and calculate the corresponding weighted input Z.

```
W = rand(4,3);
P = rand(3,1);
Z = normprod(W,P)
```

### Network Use

You can create a standard network that uses normprod by calling newgrnn.

To change a network so an input weight uses normprod, set `net.inputWeights{i,j}.weightFcn` to 'normprod'. For a layer weight, set `net.layerWeights{i,j}.weightFcn` to 'normprod'.

In either case, call `sim` to simulate the network with normprod. See newgrnn for simulation examples.

### Algorithms

normprod returns the dot product normalized by the sum of the input vector elements.

$z = w * p / \text{sum}(p)$

## **See Also**

dotprod

**Introduced before R2006a**

## **normr**

Normalize rows of matrix

### **Syntax**

`normr(M)`

### **Description**

`normr(M)` normalizes the rows of `M` to a length of 1.

### **Examples**

```
m = [1 2; 3 4];  
normr(m)  
ans =  
    0.4472    0.8944  
    0.6000    0.8000
```

### **See Also**

`normc`

**Introduced before R2006a**

# nprtool

Neural Net Pattern Recognition tool

## Syntax

```
nprtool
```

## Description

nprtool opens the Neural Net Pattern Recognition tool.

For more information and an example of its usage, see “Classify Patterns with a Shallow Neural Network”.

## Algorithms

nprtool leads you through solving a pattern-recognition classification problem using a two-layer feed-forward `patternnet` network with sigmoid output neurons.

## See Also

nctool | nftool | ntstool

**Introduced in R2008a**

## **ntstool**

Neural network time series tool

### **Syntax**

```
ntstool  
ntstool('close')
```

### **Description**

`ntstool` opens the neural network time series tool and leads you through solving a fitting problem using a two-layer feed-forward network.

For more information and an example of its usage, see “Shallow Neural Network Time-Series Prediction and Modeling”.

`ntstool('close')` closes the tool.

### **See Also**

`nctool` | `nftool` | `nprtool`

**Introduced in R2010b**

# num2deriv

Numeric two-point network derivative function

## Syntax

```
num2deriv('dperf_dwb',net,X,T,Xi,Ai,EW)
num2deriv('de_dwb',net,X,T,Xi,Ai,EW)
```

## Description

This function calculates derivatives using the two-point numeric derivative rule.

$$\frac{dy}{dx} = \frac{y(x + dx) - y(x)}{dx}$$

This function is much slower than the analytical (non-numerical) derivative functions, but is provided as a means of checking the analytical derivative functions. The other numerical function, `num5deriv`, is slower but more accurate.

`num2deriv('dperf_dwb',net,X,T,Xi,Ai,EW)` takes these arguments,

<code>net</code>	Neural network
<code>X</code>	Inputs, an $R \times Q$ matrix (or $N \times TS$ cell array of $R \times Q$ matrices)
<code>T</code>	Targets, an $S \times Q$ matrix (or $M \times TS$ cell array of $S \times Q$ matrices)
<code>Xi</code>	Initial input delay states (optional)
<code>Ai</code>	Initial layer delay states (optional)
<code>EW</code>	Error weights (optional)

and returns the gradient of performance with respect to the network's weights and biases, where  $R$  and  $S$  are the number of input and output elements and  $Q$  is the number of samples (and  $N$  and  $M$  are the number of input and output signals,  $R_i$  and  $S_i$  are the number of each input and outputs elements, and  $TS$  is the number of timesteps).

`num2deriv('de_dwb',net,X,T,Xi,Ai,EW)` returns the Jacobian of errors with respect to the network's weights and biases.

## Examples

Here a feedforward network is trained and both the gradient and Jacobian are calculated.

```
[x,t] = simplefit_dataset;
net = feedforwardnet(20);
net = train(net,x,t);
y = net(x);
perf = perform(net,t,y);
dwb = num2deriv('dperf_dwb',net,x,t)
```

**See Also**

`bttderiv` | `defaultderiv` | `fpderiv` | `num5deriv` | `staticderiv`

**Introduced in R2010b**



## num5deriv

Numeric five-point stencil neural network derivative function

### Syntax

```
num5deriv('dperf_dwb',net,X,T,Xi,Ai,EW)
num5deriv('de_dwb',net,X,T,Xi,Ai,EW)
```

### Description

This function calculates derivatives using the five-point numeric derivative rule.

$$\begin{aligned}
 y_1 &= y(x + 2dx) \\
 y_2 &= y(x + dx) \\
 y_3 &= y(x - dx) \\
 y_4 &= y(x - 2dx) \\
 \frac{dy}{dx} &= \frac{-y_1 + 8y_2 - 8y_3 + y_4}{12dx}
 \end{aligned}$$

This function is much slower than the analytical (non-numerical) derivative functions, but is provided as a means of checking the analytical derivative functions. The other numerical function, `num2deriv`, is faster but less accurate.

`num5deriv('dperf_dwb',net,X,T,Xi,Ai,EW)` takes these arguments,

<code>net</code>	Neural network
<code>X</code>	Inputs, an $R \times Q$ matrix (or $N \times TS$ cell array of $R \times Q$ matrices)
<code>T</code>	Targets, an $S \times Q$ matrix (or $M \times TS$ cell array of $S \times Q$ matrices)
<code>Xi</code>	Initial input delay states (optional)
<code>Ai</code>	Initial layer delay states (optional)
<code>EW</code>	Error weights (optional)

and returns the gradient of performance with respect to the network's weights and biases, where  $R$  and  $S$  are the number of input and output elements and  $Q$  is the number of samples (and  $N$  and  $M$  are the number of input and output signals,  $R_i$  and  $S_i$  are the number of each input and outputs elements, and  $TS$  is the number of timesteps).

`num5deriv('de_dwb',net,X,T,Xi,Ai,EW)` returns the Jacobian of errors with respect to the network's weights and biases.

### Examples

Here a feedforward network is trained and both the gradient and Jacobian are calculated.

```
[x,t] = simplefit_dataset;
net = feedforwardnet(20);
```

```
net = train(net,x,t);  
y = net(x);  
perf = perform(net,t,y);  
dwb = num5deriv('dperf_dwb',net,x,t)
```

### **See Also**

[bttderiv](#) | [defaultderiv](#) | [fpderiv](#) | [num2deriv](#) | [staticderiv](#)

**Introduced in R2010b**

# numelements

Number of elements in neural network data

## Syntax

```
numelements(x)
```

## Description

`numelements(x)` takes neural network data `x` in matrix or cell array form, and returns the number of elements in each signal.

If `x` is a matrix the result is the number of rows of `x`.

If `x` is a cell array the result is an `S`-by-1 vector, where `S` is the number of signals (i.e., rows of `X`), and each element `S(i)` is the number of elements in each signal `i` (i.e., rows of `x{i,1}`).

## Examples

This code calculates the number of elements represented by matrix data:

```
x = [1 2 3; 4 7 4]
n = numelements(x)
```

This code calculates the number of elements represented by cell data:

```
x = {[1:3; 4:6] [7:9; 10:12]; [13:15] [16:18]}
n = numelements(x)
```

## See Also

[catelements](#) | [getelements](#) | [nndata](#) | [nnsizes](#) | [numsamples](#) | [numsignals](#) | [numtimesteps](#) | [setelements](#)

**Introduced in R2010b**

## numfinite

Number of finite values in neural network data

### Syntax

```
numfinite(x)
```

### Description

`numfinite(x)` takes a matrix or cell array of matrices and returns the number of finite elements in it.

### Examples

```
x = [1 2; 3 NaN]
n = numfinite(x)
```

```
x = {[1 2; 3 NaN] [5 NaN; NaN 8]}
n = numfinite(x)
```

### See Also

[nndata](#) | [nnsizes](#) | [numnan](#)

**Introduced in R2010b**

## numnan

Number of NaN values in neural network data

### Syntax

```
numnan(x)
```

### Description

`numnan(x)` takes a matrix or cell array of matrices and returns the number of NaN elements in it.

### Examples

```
x = [1 2; 3 NaN]
n = numnan(x)
```

```
x = {[1 2; 3 NaN] [5 NaN; NaN 8]}
n = numnan(x)
```

### See Also

[nndata](#) | [nnsizes](#) | [numnan](#)

**Introduced in R2010b**

## numsamples

Number of samples in neural network data

### Syntax

```
numsamples(x)
```

### Description

`numsamples(x)` takes neural network data `x` in matrix or cell array form, and returns the number of samples.

If `x` is a matrix, the result is the number of columns of `x`.

If `x` is a cell array, the result is the number of columns of the matrices in `x`.

### Examples

This code calculates the number of samples represented by matrix data:

```
x = [1 2 3; 4 7 4]
n = numsamples(x)
```

This code calculates the number of samples represented by cell data:

```
x = {[1:3; 4:6] [7:9; 10:12]; [13:15] [16:18]}
n = numsamples(x)
```

### See Also

[catsamples](#) | [getsamples](#) | [nndata](#) | [nnsz](#) | [numelements](#) | [numsignals](#) | [numtimesteps](#) | [setsamples](#)

**Introduced in R2010b**

# numsignals

Number of signals in neural network data

## Syntax

```
numsignals(x)
```

## Description

`numsignals(x)` takes neural network data `x` in matrix or cell array form, and returns the number of signals.

If `x` is a matrix, the result is 1.

If `x` is a cell array, the result is the number of rows in `x`.

## Examples

This code calculates the number of signals represented by matrix data:

```
x = [1 2 3; 4 7 4]
n = numsignals(x)
```

This code calculates the number of signals represented by cell data:

```
x = {[1:3; 4:6] [7:9; 10:12]; [13:15] [16:18]}
n = numsignals(x)
```

## See Also

[catsignals](#) | [getsignals](#) | [nndata](#) | [nnsizes](#) | [numelements](#) | [numsamples](#) | [numtimesteps](#) | [setsignals](#)

**Introduced in R2010b**

## numtimesteps

Number of time steps in neural network data

### Syntax

```
numtimesteps(x)
```

### Description

`numtimesteps(x)` takes neural network data `x` in matrix or cell array form, and returns the number of signals.

If `x` is a matrix, the result is 1.

If `x` is a cell array, the result is the number of columns in `x`.

### Examples

This code calculates the number of time steps represented by matrix data:

```
x = [1 2 3; 4 7 4]
n = numtimesteps(x)
```

This code calculates the number of time steps represented by cell data:

```
x = {[1:3; 4:6] [7:9; 10:12]; [13:15] [16:18]}
n = numtimesteps(x)
```

### See Also

[cattimesteps](#) | [gettimesteps](#) | [nndata](#) | [nnsz](#) | [numelements](#) | [numsamples](#) | [numsignals](#) | [setimesteps](#)

**Introduced in R2010b**



## openloop

Convert neural network closed-loop feedback to open loop

### Syntax

```
net = openloop(net)
[net,xi,ai] = openloop(net,xi,ai)
```

### Description

`net = openloop(net)` takes a neural network and opens any closed-loop feedback. For each feedback output `i` whose property `net.outputs{i}.feedbackMode` is 'closed', it replaces its associated feedback layer weights with a new input and input weight connections. The `net.outputs{i}.feedbackMode` property is set to 'open', and the `net.outputs{i}.feedbackInput` property is set to the index of the new input. Finally, the value of `net.outputs{i}.feedbackDelays` is subtracted from the delays of the feedback input weights (i.e., to the delays values of the replaced layer weights).

`[net,xi,ai] = openloop(net,xi,ai)` converts a closed-loop network and its current input delay states `xi` and layer delay states `ai` to open-loop form.

### Examples

#### Convert NARX Network to Open-Loop Form

Here a NARX network is designed in open-loop form and then converted to closed-loop form, then converted back.

```
[X,T] = simplenarx_dataset;
net = narxnet(1:2,1:2,10);
[Xs,Xi,Ai,Ts] = preparets(net,X,{},T);
net = train(net,Xs,Ts,Xi,Ai);
view(net)
Yopen = net(Xs,Xi,Ai)
net = closeloop(net)
view(net)
[Xs,Xi,Ai,Ts] = preparets(net,X,{},T);
Yclosed = net(Xs,Xi,Ai);
net = openloop(net)
view(net)
[Xs,Xi,Ai,Ts] = preparets(net,X,{},T);
Yopen = net(Xs,Xi,Ai)
```

#### Convert Delay States

For examples on using `closeloop` and `openloop` to implement multistep prediction, see `narxnet` and `narnet`.

### See Also

`closeloop` | `narnet` | `narxnet` | `noloop`

**Introduced in R2010b**

# patternnet

Pattern recognition network

## Syntax

```
patternnet(hiddenSizes,trainFcn,performFcn)
```

## Description

Pattern recognition networks are feedforward networks that can be trained to classify inputs according to target classes. The target data for pattern recognition networks should consist of vectors of all zero values except for a 1 in element  $i$ , where  $i$  is the class they are to represent.

`patternnet(hiddenSizes,trainFcn,performFcn)` takes these arguments,

<code>hiddenSizes</code>	Row vector of one or more hidden layer sizes (default = 10)
<code>trainFcn</code>	Training function (default = 'trainscg')
<code>performFcn</code>	Performance function (default = 'crossentropy')

and returns a pattern recognition neural network.

## Examples

### Pattern Recognition

This example shows how to design a pattern recognition network to classify iris flowers.

```
[x,t] = iris_dataset;
net = patternnet(10);
net = train(net,x,t);
view(net)
y = net(x);
perf = perform(net,t,y);
classes = vec2ind(y);
```

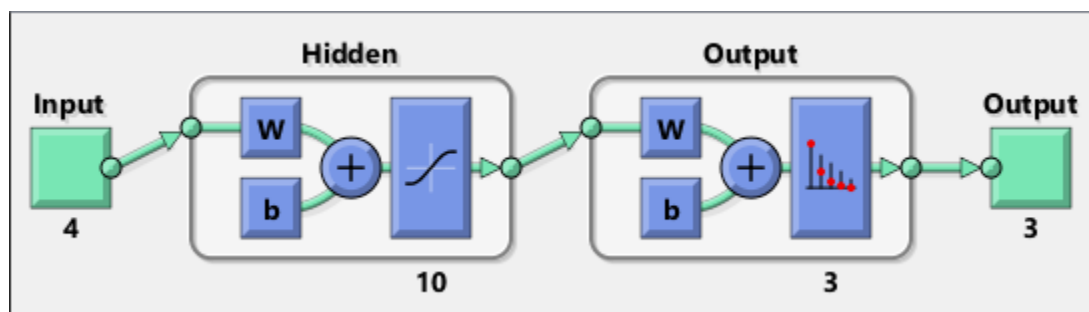

## See Also

[competlayer](#) | [lvqnet](#) | [network](#) | [nprtool](#) | [selforgmap](#)

**Topics**

“Classify Patterns with a Shallow Neural Network”

“Neural Network Object Properties”

“Neural Network Subobject Properties”

**Introduced in R2010b**

# perceptron

Perceptron

## Syntax

```
perceptron(hardlimitTF,perceptronLF)
```

## Description

Perceptrons are simple single-layer binary classifiers, which divide the input space with a linear decision boundary.

Perceptrons can learn to solve a narrow range of classification problems. They were one of the first neural networks to reliably solve a given class of problem, and their advantage is a simple learning rule.

`perceptron(hardlimitTF,perceptronLF)` takes these arguments,

<code>hardlimitTF</code>	Hard limit transfer function (default = 'hardlim')
<code>perceptronLF</code>	Perceptron learning rule (default = 'learnp')

and returns a perceptron.

In addition to the default hard limit transfer function, perceptrons can be created with the `hardlims` transfer function. The other option for the perceptron learning rule is `learnpn`.

---

**Note** Deep Learning Toolbox supports perceptrons for historical interest. For better results, you should instead use `patternnet`, which can solve nonlinearly separable problems. Sometimes the term “perceptrons” refers to feed-forward pattern recognition networks; but the original perceptron, described here, can solve only simple problems.

---

## Examples

### Solve Simple Classification Problem Using Perceptron

Use a perceptron to solve a simple classification logical-OR problem.

```
x = [0 0 1 1; 0 1 0 1];
t = [0 1 1 1];
net = perceptron;
net = train(net,x,t);
view(net)
y = net(x);
```

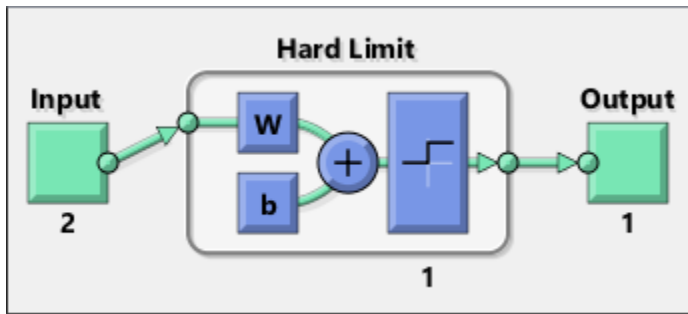

**See Also**

narnet | narxnet | patternnet | preparets | removedelay | timedelaynet

**Introduced in R2010b**

# perform

Calculate network performance

## Syntax

```
perform(net,t,y,ew)
```

## Description

`perform(net,t,y,ew)` takes these arguments,

<code>net</code>	Neural network
<code>t</code>	Target data
<code>y</code>	Output data
<code>ew</code>	Error weights (default = {1})

and returns network performance calculated according to the `net.performFcn` and `net.performParam` property values.

The target and output data must have the same dimensions. The error weights may be the same dimensions as the targets, in the most general case, but may also have any of its dimensions be 1. This gives the flexibility of defining error weights across any dimension desired.

Error weights can be defined by sample, output element, time step, or network output:

```
ew = [1.0 0.5 0.7 0.2]; % Across 4 samples
ew = [0.1; 0.5; 1.0]; % Across 3 elements
ew = {0.1 0.2 0.3 0.5 1.0}; % Across 5 timesteps
ew = {1.0; 0.5}; % Across 2 outputs
```

The error weights can also be defined across any combination, such as across two time-series (i.e., two samples) over four timesteps.

```
ew = {[0.5 0.4],[0.3 0.5],[1.0 1.0],[0.7 0.5]};
```

In the general case, error weights may have exactly the same dimensions as targets, in which case each target value will have an associated error weight.

The default error weight treats all errors the same.

```
ew = {1}
```

## Examples

Here a simple fitting problem is solved with a feed-forward network and its performance calculated.

```
[x,t] = simplefit_dataset;
net = feedforwardnet(20);
net = train(net,x,t);
y = net(x);
perf = perform(net,t,y)
```

perf =

2.3654e-06

### **See Also**

`configure` | `init` | `train`

**Introduced in R2010b**



# plotconfusion

Plot classification confusion matrix

## Syntax

```
plotconfusion(targets, outputs)
plotconfusion(targets, outputs, name)
plotconfusion(targets1, outputs1, name1, targets2, outputs2, name2, ..., targetsn, outputsn, namen)
```

## Description

`plotconfusion(targets, outputs)` plots a confusion matrix for the true labels `targets` and predicted labels `outputs`. Specify the labels as categorical vectors, or in one-of-N (one-hot) form.

On the confusion matrix plot, the rows correspond to the predicted class (Output Class) and the columns correspond to the true class (Target Class). The diagonal cells correspond to observations that are correctly classified. The off-diagonal cells correspond to incorrectly classified observations. Both the number of observations and the percentage of the total number of observations are shown in each cell.

The column on the far right of the plot shows the percentages of all the examples predicted to belong to each class that are correctly and incorrectly classified. These metrics are often called the precision (or positive predictive value) and false discovery rate, respectively. The row at the bottom of the plot shows the percentages of all the examples belonging to each class that are correctly and incorrectly classified. These metrics are often called the recall (or true positive rate) and false negative rate, respectively. The cell in the bottom right of the plot shows the overall accuracy.

`plotconfusion(targets, outputs, name)` plots a confusion matrix and adds `name` to the beginning of the plot title.

`plotconfusion(targets1, outputs1, name1, targets2, outputs2, name2, ..., targetsn, outputsn, namen)` plots multiple confusion matrices in one figure and adds the `name` arguments to the beginnings of the titles of the corresponding plots.

## Examples

### Plot Confusion Matrix Using Categorical Labels

Load the data consisting of synthetic images of handwritten digits. `XTrain` is a 28-by-28-by-1-by-5000 array of images and `YTrain` is a categorical vector containing the image labels.

```
[XTrain, YTrain] = digitTrain4DArrayData;
whos YTrain
```

Name	Size	Bytes	Class	Attributes
YTrain	5000x1	6062	categorical	

Define the architecture of a convolutional neural network.

```
layers = [  
    imageInputLayer([28 28 1])  
  
    convolution2dLayer(3,8,'Padding','same')  
    batchNormalizationLayer  
    reluLayer  
    convolution2dLayer(3,16,'Padding','same','Stride',2)  
    batchNormalizationLayer  
    reluLayer  
    convolution2dLayer(3,32,'Padding','same','Stride',2)  
    batchNormalizationLayer  
    reluLayer  
  
    fullyConnectedLayer(10)  
    softmaxLayer  
    classificationLayer];
```

Specify training options and train the network.

```
options = trainingOptions('sgdm',...  
    'MaxEpochs',5,...  
    'Verbose',false,...  
    'Plots','training-progress');  
net = trainNetwork(XTrain,YTrain,layers,options);
```

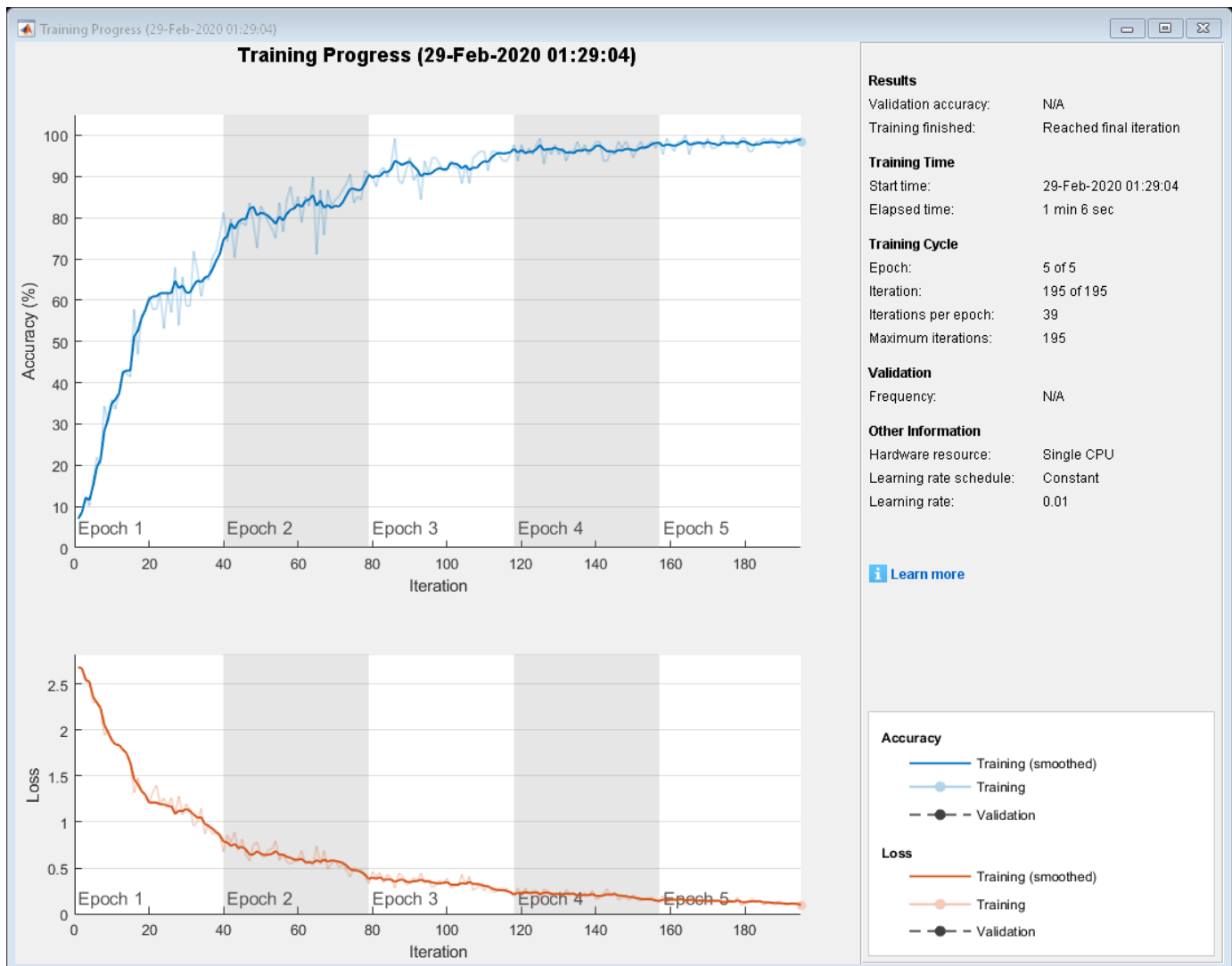

Load and classify test data using the trained network.

```
[XTest,YTest] = digitTest4DArrayData;  
YPredicted = classify(net,XTest);
```

Plot the confusion matrix of the true test labels YTest and the predicted labels YPredicted.

```
plotconfusion(YTest,YPredicted)
```

**Confusion Matrix**

0	479 9.6%	0 0.0%	0 0.0%	0 0.0%	0 0.0%	0 0.0%	1 0.0%	0 0.0%	1 0.0%	0 0.0%	99.6% 0.4%
1	0 0.0%	468 9.4%	2 0.0%	0 0.0%	4 0.1%	0 0.0%	5 0.1%	1 0.0%	0 0.0%	11 0.2%	95.3% 4.7%
2	8 0.2%	19 0.4%	482 9.6%	5 0.1%	0 0.0%	0 0.0%	4 0.1%	8 0.2%	7 0.1%	1 0.0%	90.3% 9.7%
3	0 0.0%	1 0.0%	1 0.0%	469 9.4%	0 0.0%	0 0.0%	1 0.0%	0 0.0%	5 0.1%	4 0.1%	97.5% 2.5%
4	0 0.0%	2 0.0%	0 0.0%	0 0.0%	492 9.8%	0 0.0%	1 0.0%	0 0.0%	0 0.0%	1 0.0%	99.2% 0.8%
5	1 0.0%	1 0.0%	0 0.0%	17 0.3%	0 0.0%	498 10.0%	12 0.2%	1 0.0%	8 0.2%	1 0.0%	92.4% 7.6%
6	4 0.1%	3 0.1%	4 0.1%	0 0.0%	0 0.0%	1 0.0%	461 9.2%	0 0.0%	1 0.0%	0 0.0%	97.3% 2.7%
7	0 0.0%	6 0.1%	2 0.0%	0 0.0%	0 0.0%	0 0.0%	1 0.0%	487 9.7%	0 0.0%	1 0.0%	98.0% 2.0%
8	0 0.0%	0 0.0%	2 0.0%	5 0.1%	2 0.0%	1 0.0%	2 0.0%	0 0.0%	474 9.5%	2 0.0%	97.1% 2.9%
9	8 0.2%	0 0.0%	7 0.1%	4 0.1%	2 0.0%	0 0.0%	12 0.2%	3 0.1%	4 0.1%	479 9.6%	92.3% 7.7%
	95.8% 4.2%	93.6% 6.4%	96.4% 3.6%	93.8% 6.2%	98.4% 1.6%	99.6% 0.4%	92.2% 7.8%	97.4% 2.6%	94.8% 5.2%	95.8% 4.2%	95.8% 4.2%
	0	1	2	3	4	5	6	7	8	9	
	<b>Target Class</b>										

The rows correspond to the predicted class (Output Class) and the columns correspond to the true class (Target Class). The diagonal cells correspond to observations that are correctly classified. The off-diagonal cells correspond to incorrectly classified observations. Both the number of observations and the percentage of the total number of observations are shown in each cell.

The column on the far right of the plot shows the percentages of all the examples predicted to belong to each class that are correctly and incorrectly classified. These metrics are often called the precision (or positive predictive value) and false discovery rate, respectively. The row at the bottom of the plot shows the percentages of all the examples belonging to each class that are correctly and incorrectly classified. These metrics are often called the recall (or true positive rate) and false negative rate, respectively. The cell in the bottom right of the plot shows the overall accuracy.

## Plot Confusion Matrix Using One-of-N Labels

Load sample data using the `cancer_dataset` function. `XTrain` is a 9-by-699 matrix defining nine attributes of 699 biopsies. `YTrain` is a 2-by-699 matrix where each column indicates the correct category of the corresponding observation. Each column of `YTrain` has one element that equals one in either the first or second row, corresponding to the cancer being benign or malignant, respectively. For more information on this dataset, type `help cancer_dataset` at the command line.

```
rng default
[XTrain,YTrain] = cancer_dataset;
YTrain(:,1:10)
```

```
ans = 2×10
```

```
    1    1    1    0    1    1    0    0    0    1
    0    0    0    1    0    0    1    1    1    0
```

Create a pattern recognition network and train it using the sample data.

```
net = patternnet(10);
net = train(net,XTrain,YTrain);
```

Estimate the cancer status using the trained network. Each column of the matrix `YPredicted` contains the predicted probabilities of each observation belonging to class 1 and class 2, respectively.

```
YPredicted = net(XTrain);
YPredicted(:,1:10)
```

```
ans = 2×10
```

```
    0.9999    0.9999    0.9999    0.0578    0.9993    0.9999    0.0012    0.0001    0.0028    0.9999
    0.0001    0.0001    0.0001    0.9422    0.0007    0.0001    0.9988    0.9999    0.9972    0.0001
```

Plot the confusion matrix. To create the plot, `plotconfusion` labels each observation according to the highest class probability.

```
plotconfusion(YTrain,YPredicted)
```

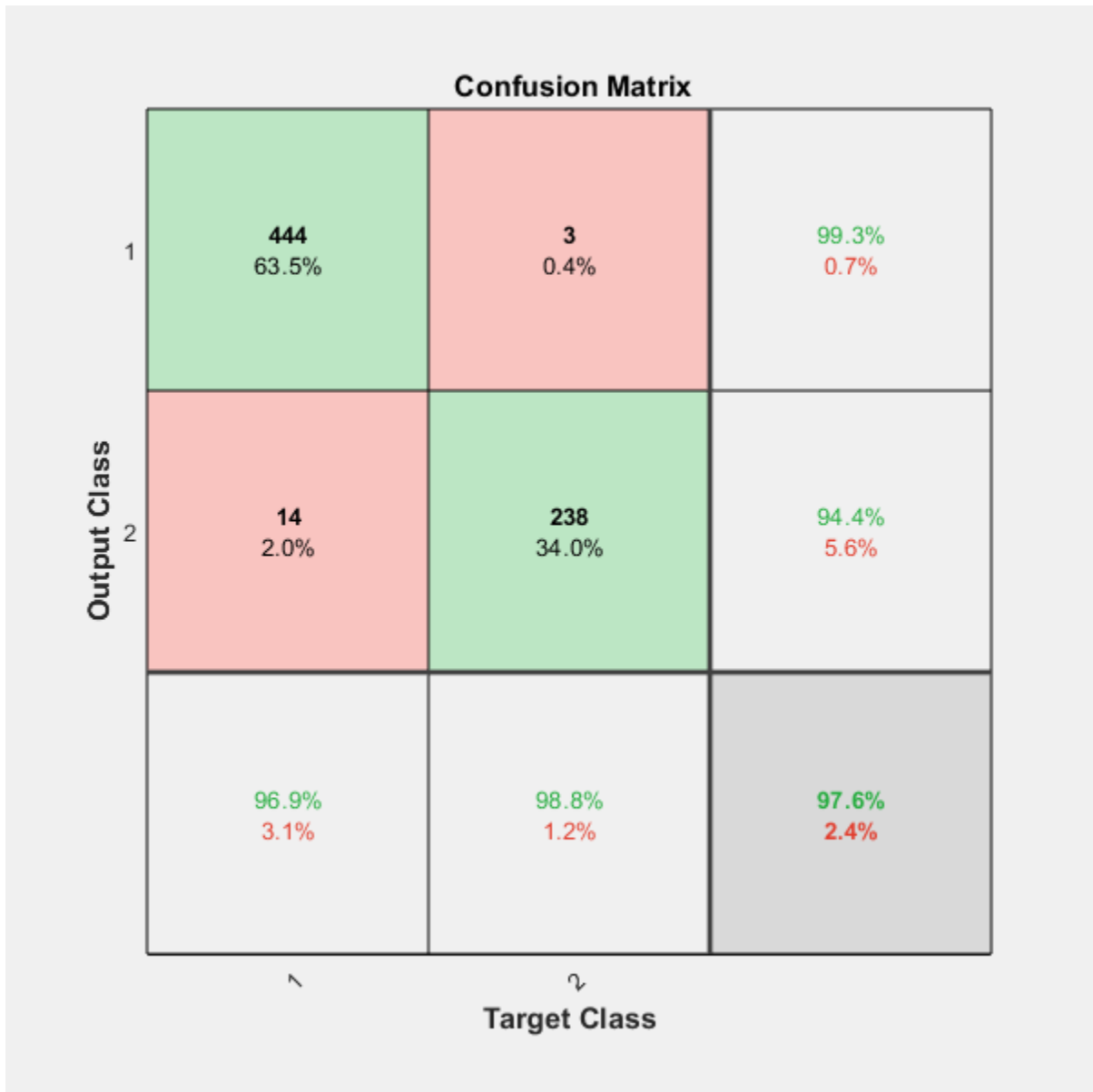

In this figure, the first two diagonal cells show the number and percentage of correct classifications by the trained network. For example, 446 biopsies are correctly classified as benign. This corresponds to 63.8% of all 699 biopsies. Similarly, 236 cases are correctly classified as malignant. This corresponds to 33.8% of all biopsies.

5 of the malignant biopsies are incorrectly classified as benign and this corresponds to 0.7% of all 699 biopsies in the data. Similarly, 12 of the benign biopsies are incorrectly classified as malignant and this corresponds to 1.7% of all data.

Out of 451 benign predictions, 98.9% are correct and 1.1% are wrong. Out of 248 malignant predictions, 95.2% are correct and 4.8% are wrong. Out of 458 benign cases, 97.4% are correctly predicted as benign and 2.6% are predicted as malignant. Out of 241 malignant cases, 97.9% are correctly classified as malignant and 2.1% are classified as benign.

Overall, 97.6% of the predictions are correct and 2.4% are wrong.

## Input Arguments

### **targets — True class labels**

categorical vector | matrix

True class labels, specified one of the following:

- A categorical vector, where each element is the class label of one observation. The `outputs` and `targets` arguments must have the same number of elements. If the categorical vectors define underlying classes, then `plotconfusion` displays all the underlying classes, even if there are no observations of some of the underlying classes. If the arguments are ordinal categorical vectors, then they must both define the same underlying categories, in the same order.
- An  $N$ -by- $M$  matrix, where  $N$  is the number of classes and  $M$  is the number of observations. Each column of the matrix must be in one-of- $N$  (one-hot) form, where a single element equal to 1 indicates the true label and all other elements equal 0.

### **outputs — Predicted class labels**

categorical vector | matrix

Predicted class labels, specified one of the following:

- A categorical vector, where each element is the class label of one observation. The `outputs` and `targets` arguments must have the same number of elements. If the categorical vectors define underlying classes, then `plotconfusion` displays all the underlying classes, even if there are no observations of some of the underlying classes. If the arguments are ordinal categorical vectors, then they must both define the same underlying categories, in the same order.
- An  $N$ -by- $M$  matrix, where  $N$  is the number of classes and  $M$  is the number of observations. Each column of the matrix can be in one-of- $N$  (one-hot) form, where a single element equal to 1 indicates the predicted label, or in the form of probabilities that sum to one.

### **name — Name of the confusion matrix**

character array

Name of the confusion matrix, specified as a character array. `plotconfusion` adds the specified name to the beginning of the plot title.

Data Types: char

## See Also

`trainNetwork` | `trainingOptions`

**Introduced in R2008a**

## plotep

Plot weight-bias position on error surface

### Syntax

```
H = plotep(W,B,E)
H = plotep(W,B,E,H)
```

### Description

plotep is used to show network learning on a plot created by plotes.

H = plotep(W,B,E) takes these arguments,

W	Current weight value
B	Current bias value
E	Current error

and returns a cell array H, containing information for continuing the plot.

H = plotep(W,B,E,H) continues plotting using the cell array H returned by the last call to plotep.

H contains handles to dots plotted on the error surface, so they can be deleted next time; as well as points on the error contour, so they can be connected.

### See Also

errsurf | plotes

**Introduced before R2006a**



## ploterrcorr

Plot autocorrelation of error time series

### Syntax

```
ploterrcorr(error)
ploterrcorr(errors, 'outputIndex', outIdx)
```

### Description

`ploterrcorr(error)` takes an error time series and plots the autocorrelation of errors across varying lags.

`ploterrcorr(errors, 'outputIndex', outIdx)` uses the optional property name/value pair to define which output error autocorrelation is plotted. The default is 1.

### Examples

#### Plot Autocorrelation of Errors

Here a NARX network is used to solve a time series problem.

```
[X,T] = simplenarx_dataset;
net = narxnet(1:2,20);
[Xs,Xi,Ai,Ts] = preparets(net,X,{},T);
net = train(net,Xs,Ts,Xi,Ai);
Y = net(Xs,Xi,Ai);
E = gsubtract(Ts,Y);
ploterrcorr(E)
```

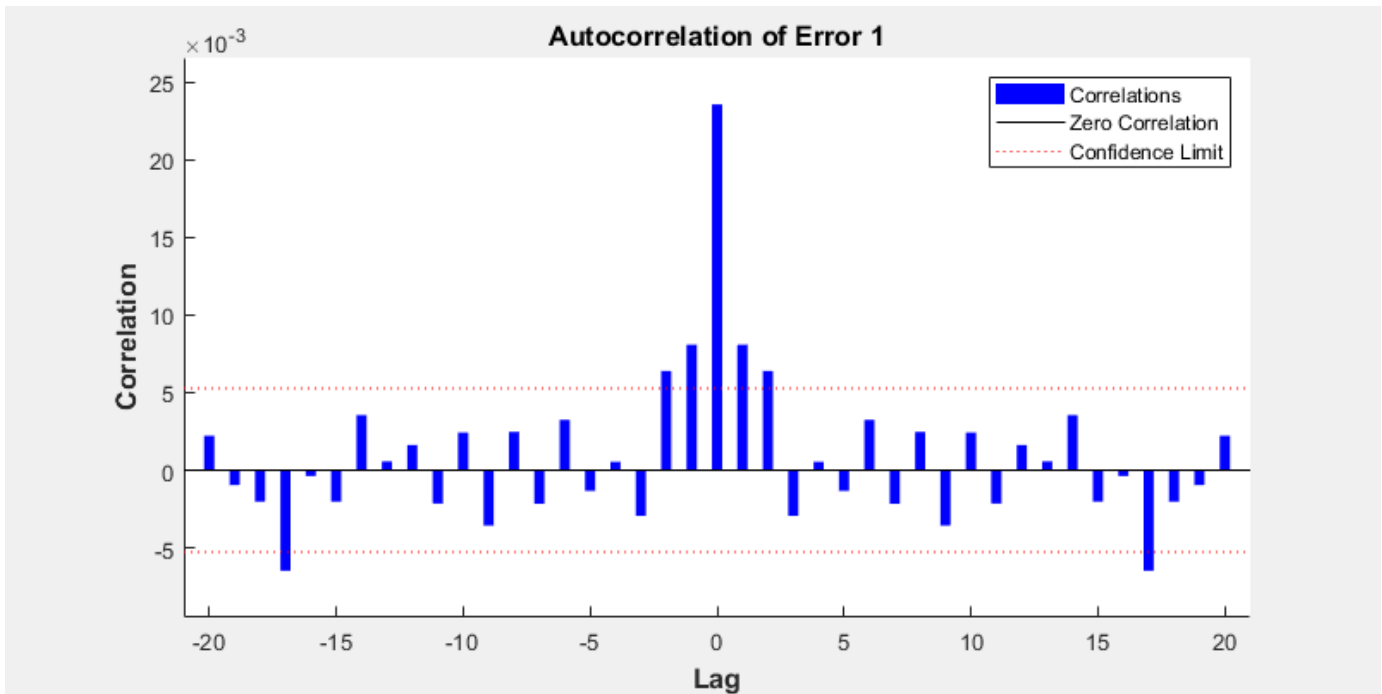

**See Also**

`plotinerrcorr` | `plotresponse`

**Introduced in R2010b**

# ploterrhist

Plot error histogram

## Syntax

```
ploterrhist(e)  
ploterrhist(e1,'name1',e2,'name2',...)  
ploterrhist(...,'bins',bins)
```

## Description

`ploterrhist(e)` plots a histogram of error values `e`.

`ploterrhist(e1,'name1',e2,'name2',...)` takes any number of errors and names and plots each pair.

`ploterrhist(...,'bins',bins)` takes an optional property name/value pair which defines the number of bins to use in the histogram plot. The default is 20.

## Examples

### Plot Histogram of Error Values

Here a feedforward network is used to solve a simple fitting problem:

```
[x,t] = simplefit_dataset;  
net = feedforwardnet(20);  
net = train(net,x,t);  
y = net(x);  
e = t - y;  
ploterrhist(e,'bins',30)
```

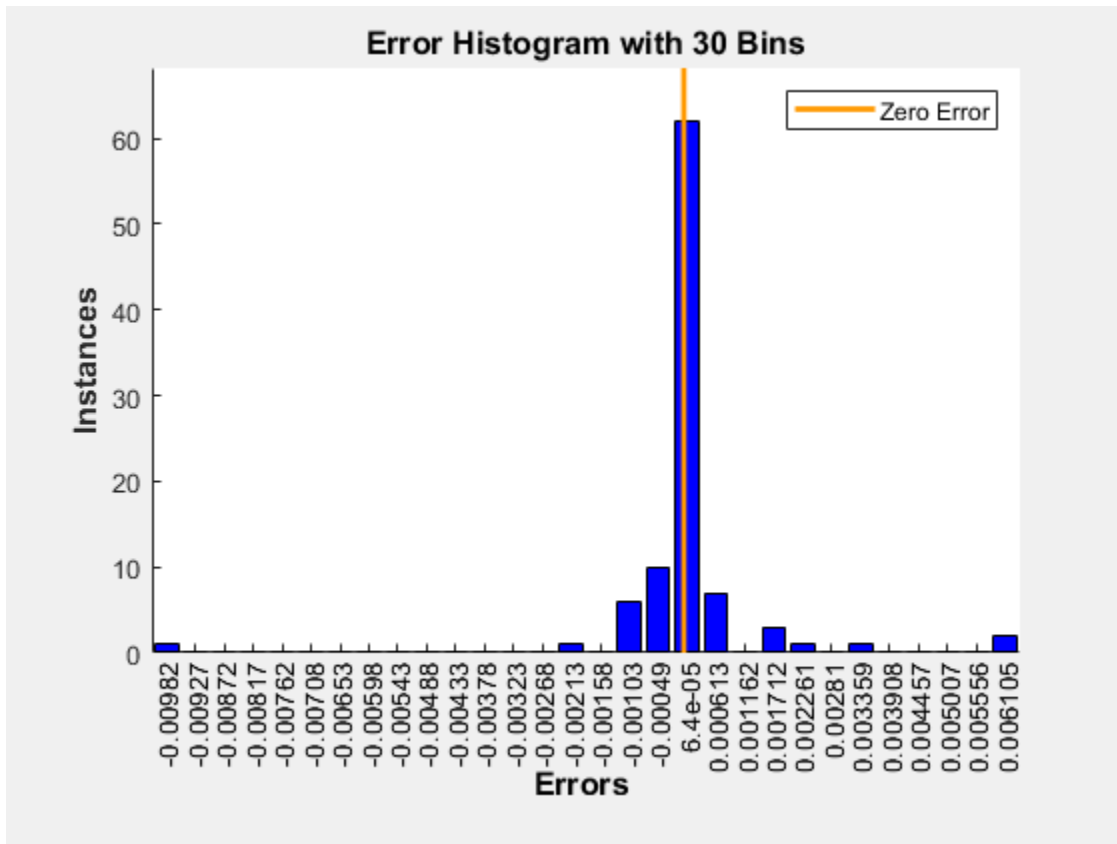

**See Also**

`plotconfusion` | `ploterrcorr` | `plotinerrcorr`

**Introduced in R2010b**

# plots

Plot error surface of single-input neuron

## Syntax

```
plots(WV,BV,ES,V)
```

## Description

`plots(WV,BV,ES,V)` takes these arguments,

WV	1-by-N row vector of values of W
BV	1-by-M row vector of values of B
ES	M-by-N matrix of error vectors
V	View (default = [-37.5, 30])

and plots the error surface with a contour underneath.

Calculate the error surface ES with `errsurf`.

## Examples

### Plot Error Surface of Single-Input Neuron

```
p = [3 2];
t = [0.4 0.8];
wv = -4:0.4:4;
bv = wv;
ES = errsurf(p,t,wv,bv,'logsig');
plots(wv,bv,ES,[60 30])
```

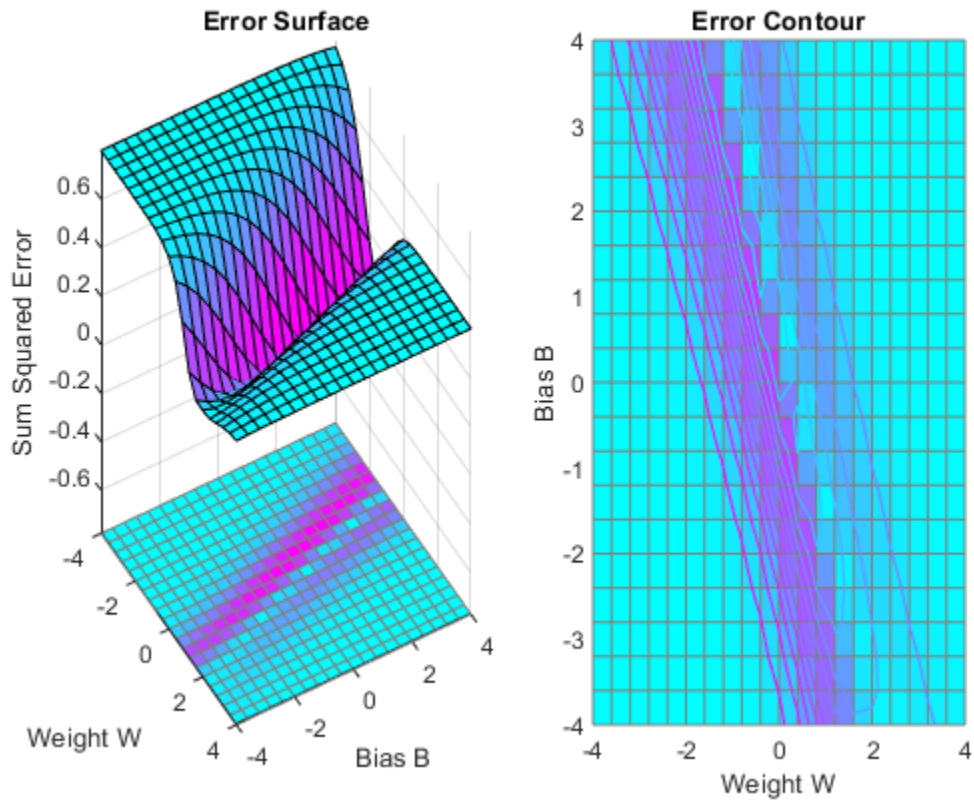

**See Also**  
errsurf

**Introduced before R2006a**

# plotfit

Plot function fit

## Syntax

```
plotfit(net,inputs,targets)
plotfit(targets1,inputs1,'name1',...)
```

## Description

`plotfit(net,inputs,targets)` plots the output function of a network across the range of the inputs `inputs` and also plots target `targets` and output data points associated with values in `inputs`. Error bars show the difference between outputs and `targets`.

The plot appears only for networks with one input.

Only the first output/targets appear if the network has more than one output.

`plotfit(targets1,inputs1,'name1',...)` displays a series of plots.

## Examples

### Plot Output and Target Values

This example shows how to use a feed-forward network to solve a simple fitting problem.

```
[x,t] = simplefit_dataset;
net = feedforwardnet(10);
net = train(net,x,t);
plotfit(net,x,t)
```

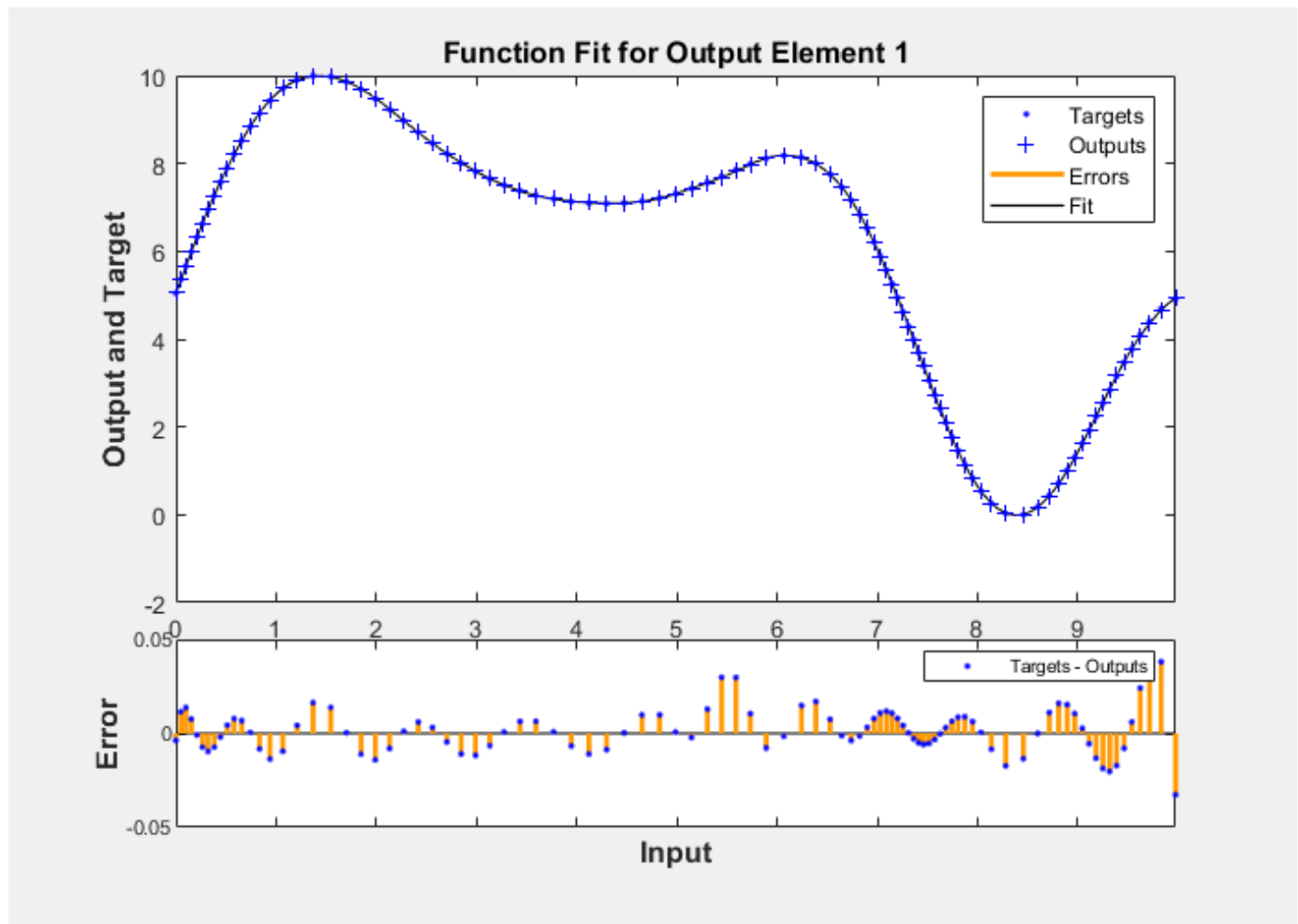

**See Also**  
plottrainstate

**Introduced in R2008a**



# plotinerrcorr

Plot input to error time-series cross-correlation

## Syntax

```
plotinerrcorr(x,e)
plotinerrcorr(...,'inputIndex',inputIndex)
plotinerrcorr(...,'outputIndex',outputIndex)
```

## Description

`plotinerrcorr(x,e)` takes an input time series `x` and an error time series `e`, and plots the cross-correlation of inputs to errors across varying lags.

`plotinerrcorr(...,'inputIndex',inputIndex)` optionally defines which input element is being correlated and plotted. The default is 1.

`plotinerrcorr(...,'outputIndex',outputIndex)` optionally defines which error element is being correlated and plotted. The default is 1.

## Examples

### Plot Cross-Correlation of Inputs to Errors

Here a NARX network is used to solve a time series problem.

```
[X,T] = simplenarx_dataset;
net = narxnet(1:2,20);
[Xs,Xi,Ai,Ts] = preparets(net,X,{},T);
net = train(net,Xs,Ts,Xi,Ai);
Y = net(Xs,Xi,Ai);
E = gsubtract(Ts,Y);
plotinerrcorr(Xs,E)
```

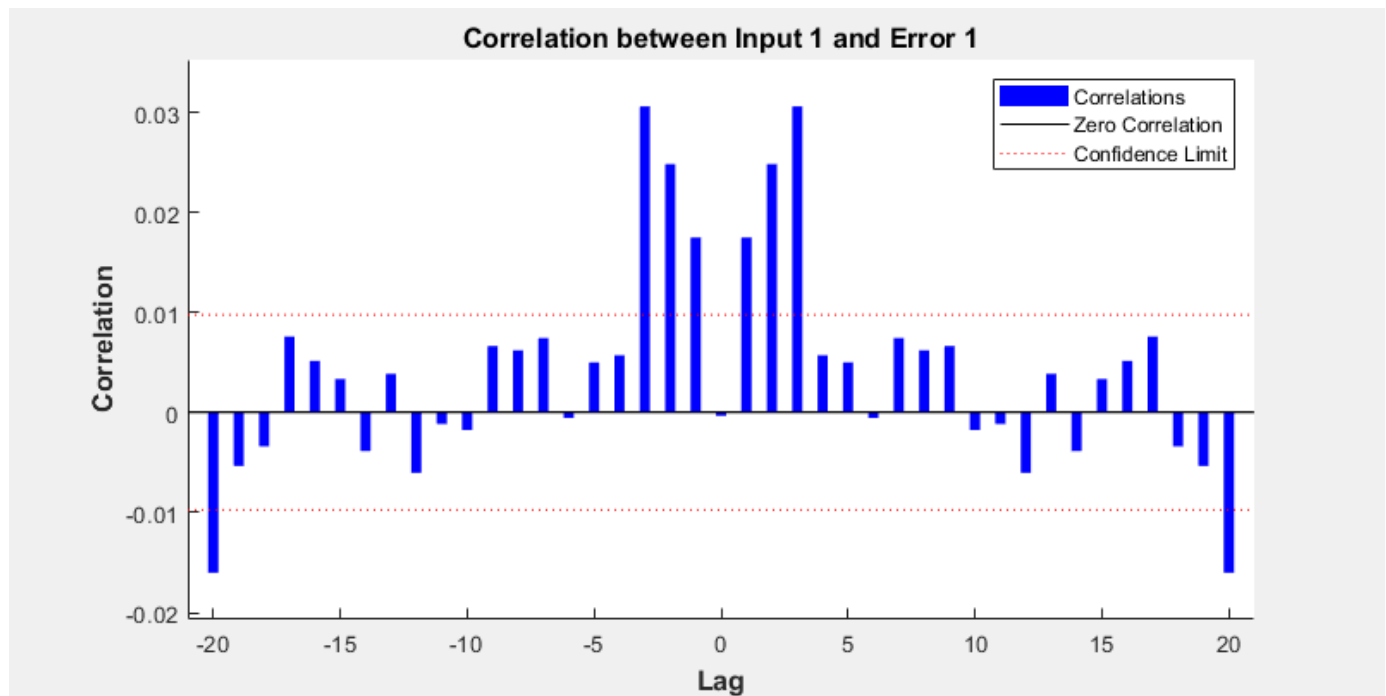

**See Also**

`ploterrcorr` | `ploterrhist` | `plotresponse`

**Introduced in R2010b**

## plotpc

Plot classification line on perceptron vector plot

### Syntax

```
plotpc(W,B)
plotpc(W,B,H)
```

### Description

plotpc(W,B) takes these inputs,

W	S-by-R weight matrix (R must be 3 or less)
B	S-by-1 bias vector

and returns a handle to a plotted classification line.

plotpc(W,B,H) takes an additional input,

H	Handle to last plotted line
---	-----------------------------

and deletes the last line before plotting the new one.

This function does not change the current axis and is intended to be called after plotpv.

### Examples

#### Plot Classification Line

The code below defines and plots the inputs and targets for a perceptron:

```
p = [0 0 1 1; 0 1 0 1];
t = [0 0 0 1];
plotpv(p,t)
```

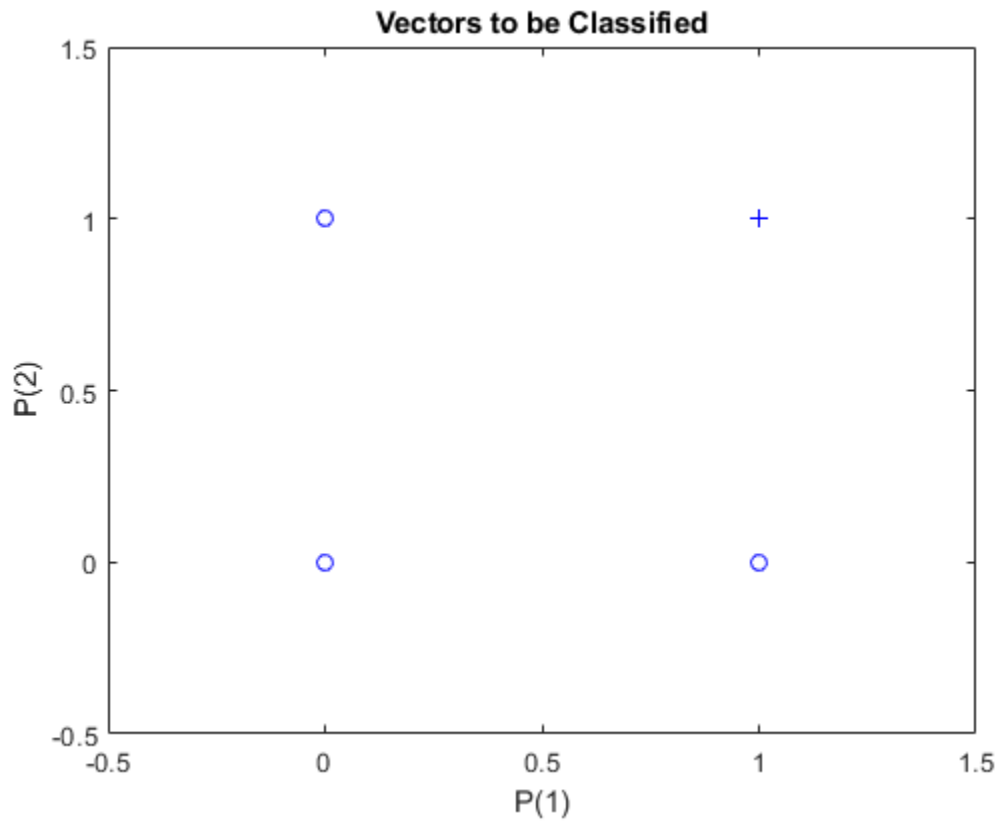

The following code creates a perceptron, assigns values to its weights and biases, and plots the resulting classification line.

```
net = perceptron;  
net = configure(net,p,t);  
net.iw{1,1} = [-1.2 -0.5];  
net.b{1} = 1;  
plotpc(net.iw{1,1},net.b{1})
```

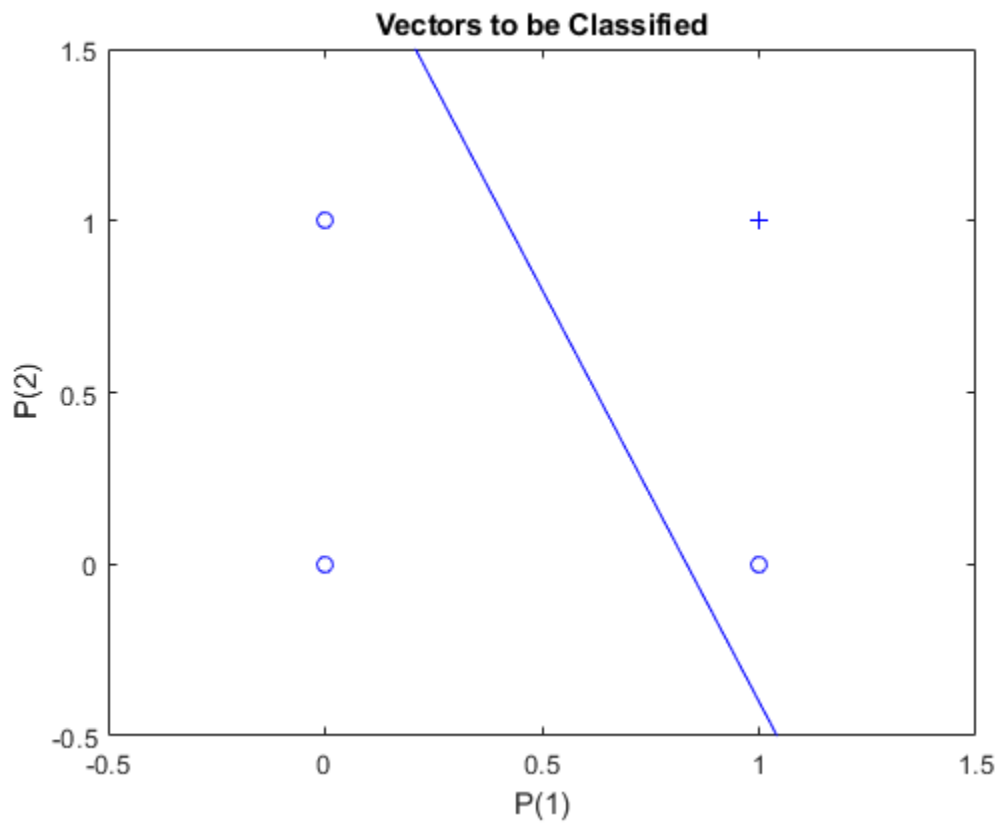
**See Also**

plotpv

Introduced before R2006a

## plotperform

Plot network performance

### Syntax

```
plotperform(TR)
```

### Description

`plotperform(TR)` plots error vs. epoch for the training, validation, and test performances of the training record `TR` returned by the function `train`.

### Examples

#### Plot Validation Performance of Network

This example shows how to use `plotperform` to obtain a plot of training record error values against the number of training epochs.

```
[x,t] = bodyfat_dataset;  
net = feedforwardnet(10);  
[net,tr] = train(net,x,t);  
plotperform(tr)
```

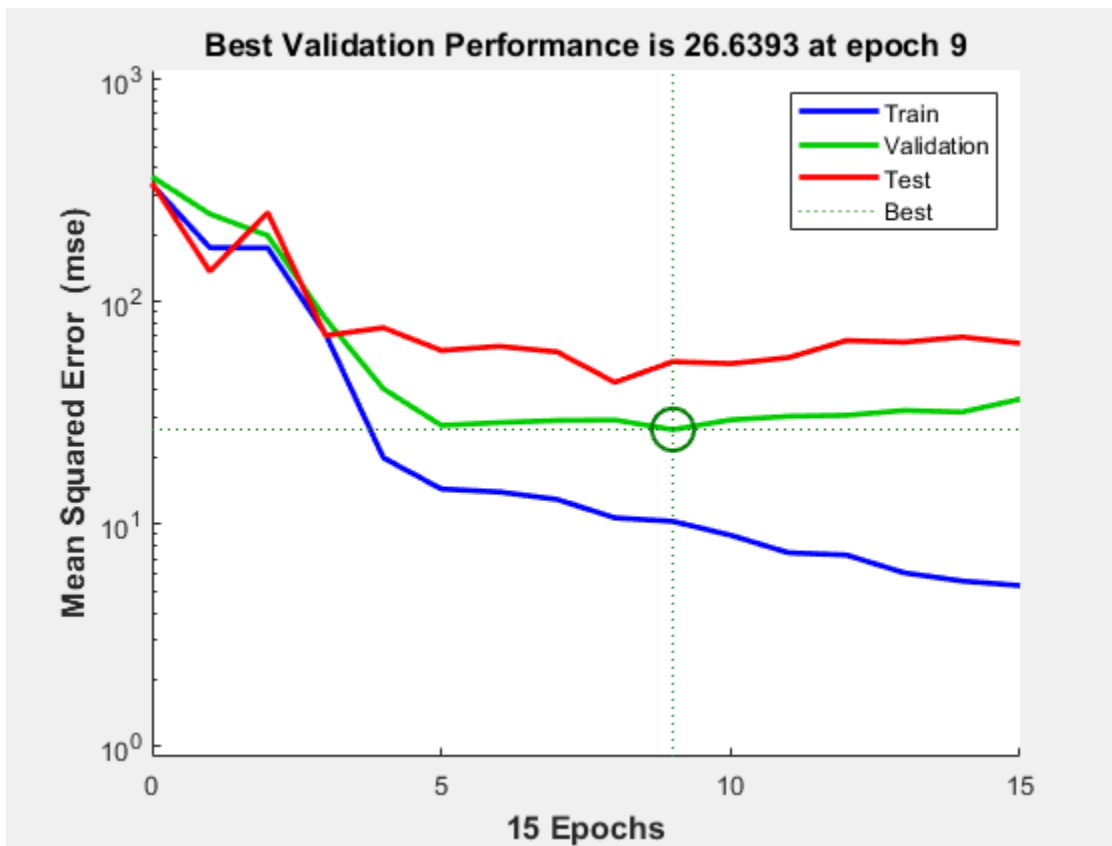

Generally, the error reduces after more epochs of training, but might start to increase on the validation data set as the network starts overfitting the training data. In the default setup, the training stops after six consecutive increases in validation error, and the best performance is taken from the epoch with the lowest validation error.

## See Also

`plottrainstate`

**Introduced in R2008a**

## plotpv

Plot perceptron input/target vectors

### Syntax

```
plotpv(P,T)  
plotpv(P,T,V)
```

### Description

plotpv(P,T) takes these inputs,

P	R-by-Q matrix of input vectors (R must be 3 or less)
T	S-by-Q matrix of binary target vectors (S must be 3 or less)

and plots column vectors in P with markers based on T.

plotpv(P,T,V) takes an additional input,

V	Graph limits = [x_min x_max y_min y_max]
---	--

and plots the column vectors with limits set by V.

### Examples

#### Plot Inputs and Targets for Perceptron

This example shows how to define and plot the inputs and targets for a perceptron.

```
p = [0 0 1 1; 0 1 0 1];  
t = [0 0 0 1];  
plotpv(p,t)
```

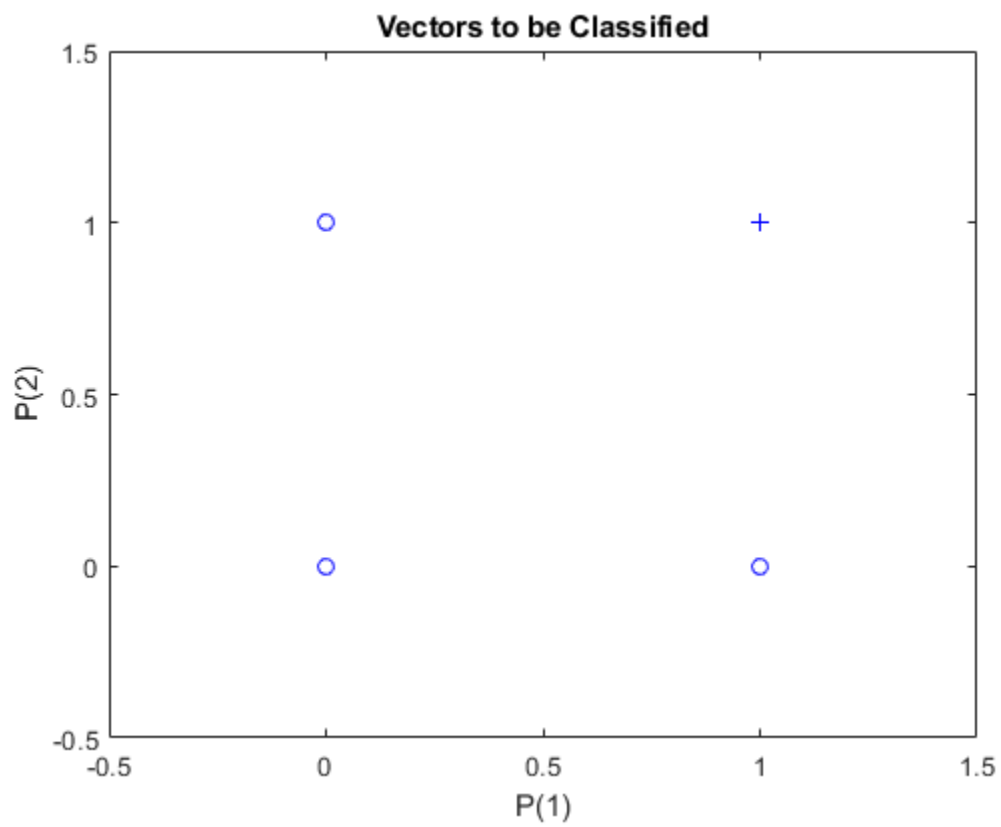

**See Also**

plotpc

Introduced before R2006a

## plotregression

Plot linear regression

### Syntax

```
plotregression(targets, outputs)
plotregression(targs1, outs1, 'name1', targs2, outs2, 'name2', ...)
```

### Description

`plotregression(targets, outputs)` plots the linear regression of targets relative to outputs.

`plotregression(targs1, outs1, 'name1', targs2, outs2, 'name2', ...)` generates multiple plots.

### Examples

#### Plot Linear Regression

```
[x,t] = simplefit_dataset;
net = feedforwardnet(10);
net = train(net,x,t);
y = net(x);
plotregression(t,y, 'Regression')
```

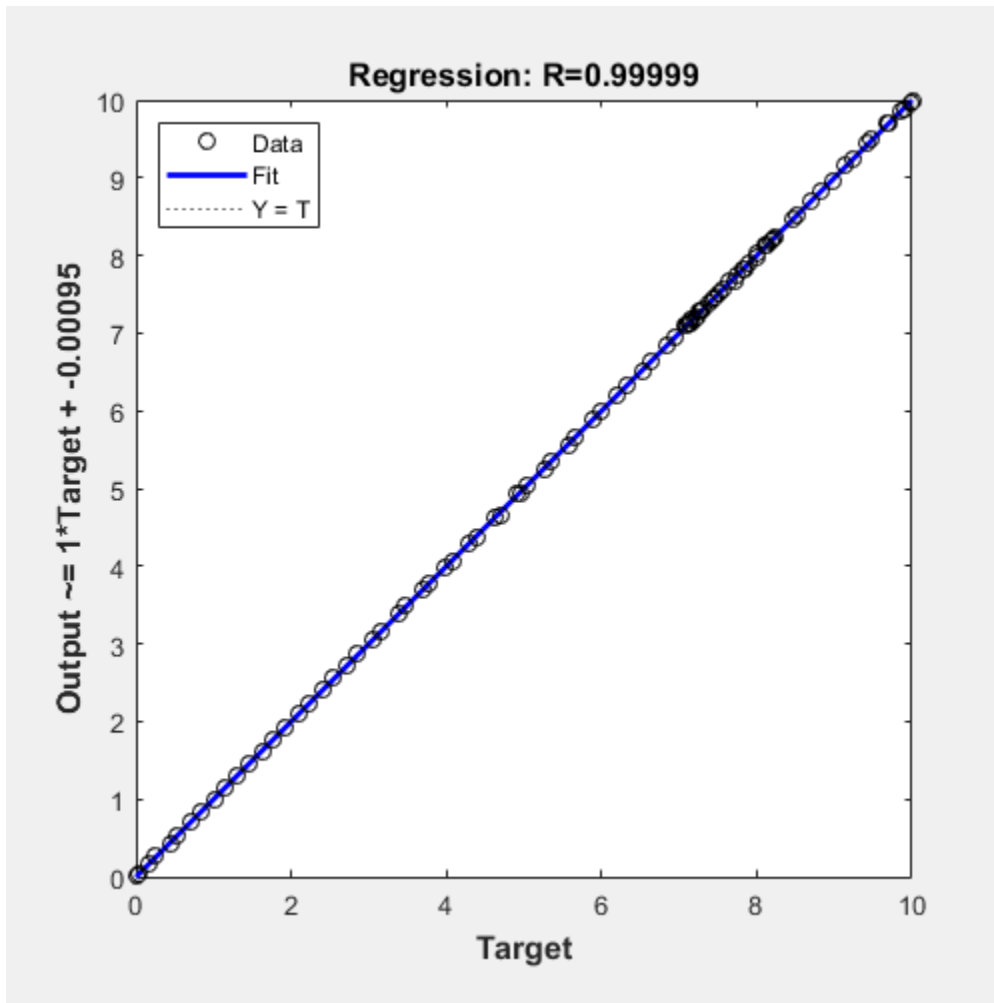

### See Also

plottrainstate

Introduced in R2008a

## plotresponse

Plot dynamic network time series response

### Syntax

```
plotresponse(t,y)
plotresponse(t1,'name',t2,'name2',...,y)
plotresponse(...,'outputIndex',outputIndex)
```

### Description

`plotresponse(t,y)` takes a target time series `t` and an output time series `y`, and plots them on the same axis showing the errors between them.

`plotresponse(t1,'name',t2,'name2',...,y)` takes multiple target/name pairs, typically defining training, validation and testing targets, and the output. It plots the responses with colors indicating the different target sets.

`plotresponse(...,'outputIndex',outputIndex)` optionally defines which error element is being correlated and plotted. The default is 1.

### Examples

#### Plot Target and Output Time Series Data

This example shows how to use a NARX network to solve a time series problem.

```
[X,T] = simplenarx_dataset;
net = narxnet(1:2,20);
[Xs,Xi,Ai,Ts] = preparets(net,X,{},T);
net = train(net,Xs,Ts,Xi,Ai);
Y = net(Xs,Xi,Ai);
plotresponse(Ts,Y)
```

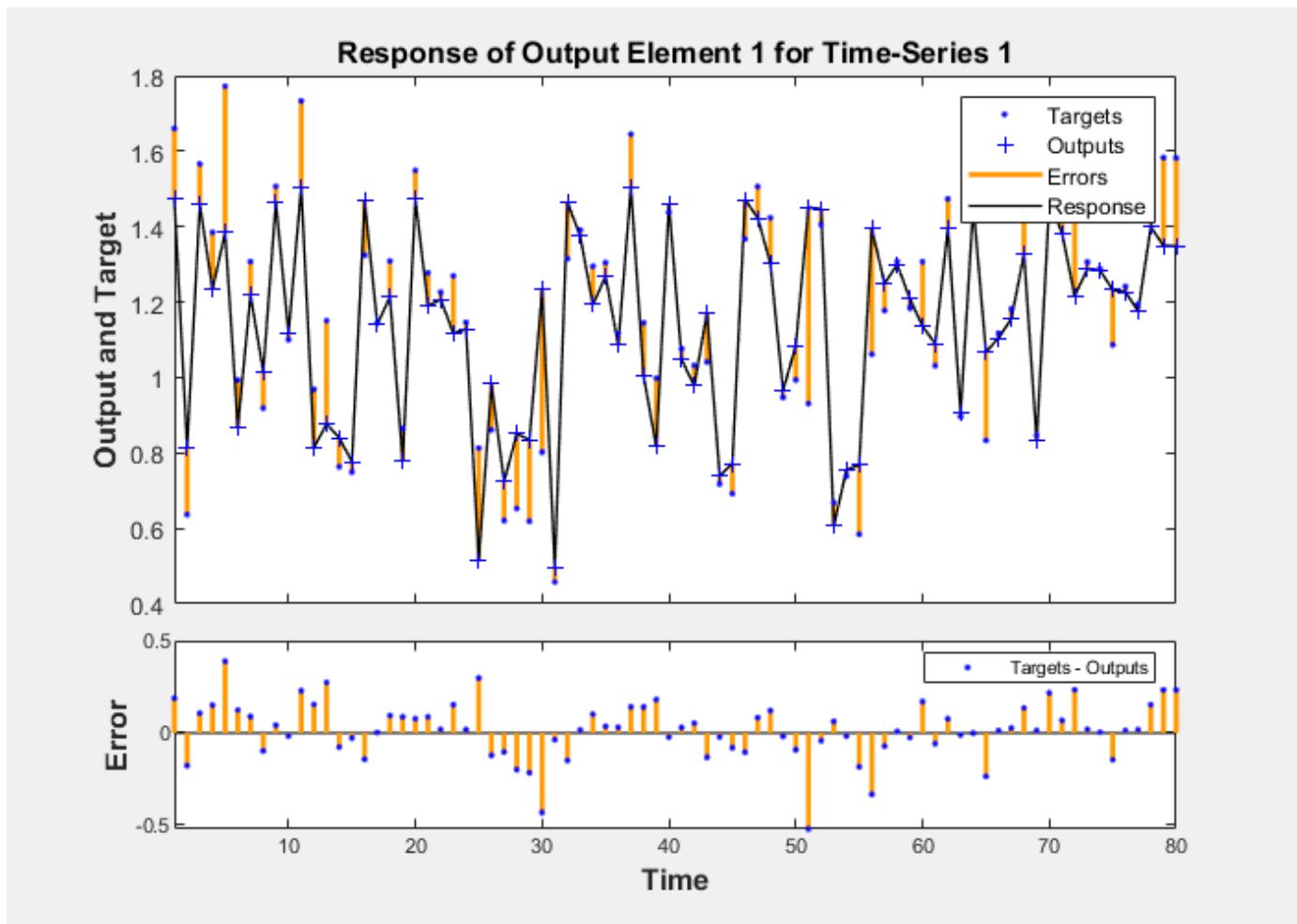

### See Also

[ploterrcorr](#) | [ploterrhist](#) | [plotinerrcorr](#)

**Introduced in R2010b**

## plotroc

Plot receiver operating characteristic

### Syntax

```
plotroc(targets,outputs)  
plotroc(targets1,outputs2,'name1',...)
```

### Description

`plotroc(targets,outputs)` plots the receiver operating characteristic for each output class. The more each curve hugs the left and top edges of the plot, the better the classification.

`plotroc(targets1,outputs2,'name1',...)` generates multiple plots.

### Examples

#### Plot Receiver Operating Characteristic

```
load simplecluster_dataset  
net = patternnet(20);  
net = train(net,simpleclusterInputs,simpleclusterTargets);  
simpleclusterOutputs = sim(net,simpleclusterInputs);  
plotroc(simpleclusterTargets,simpleclusterOutputs)
```

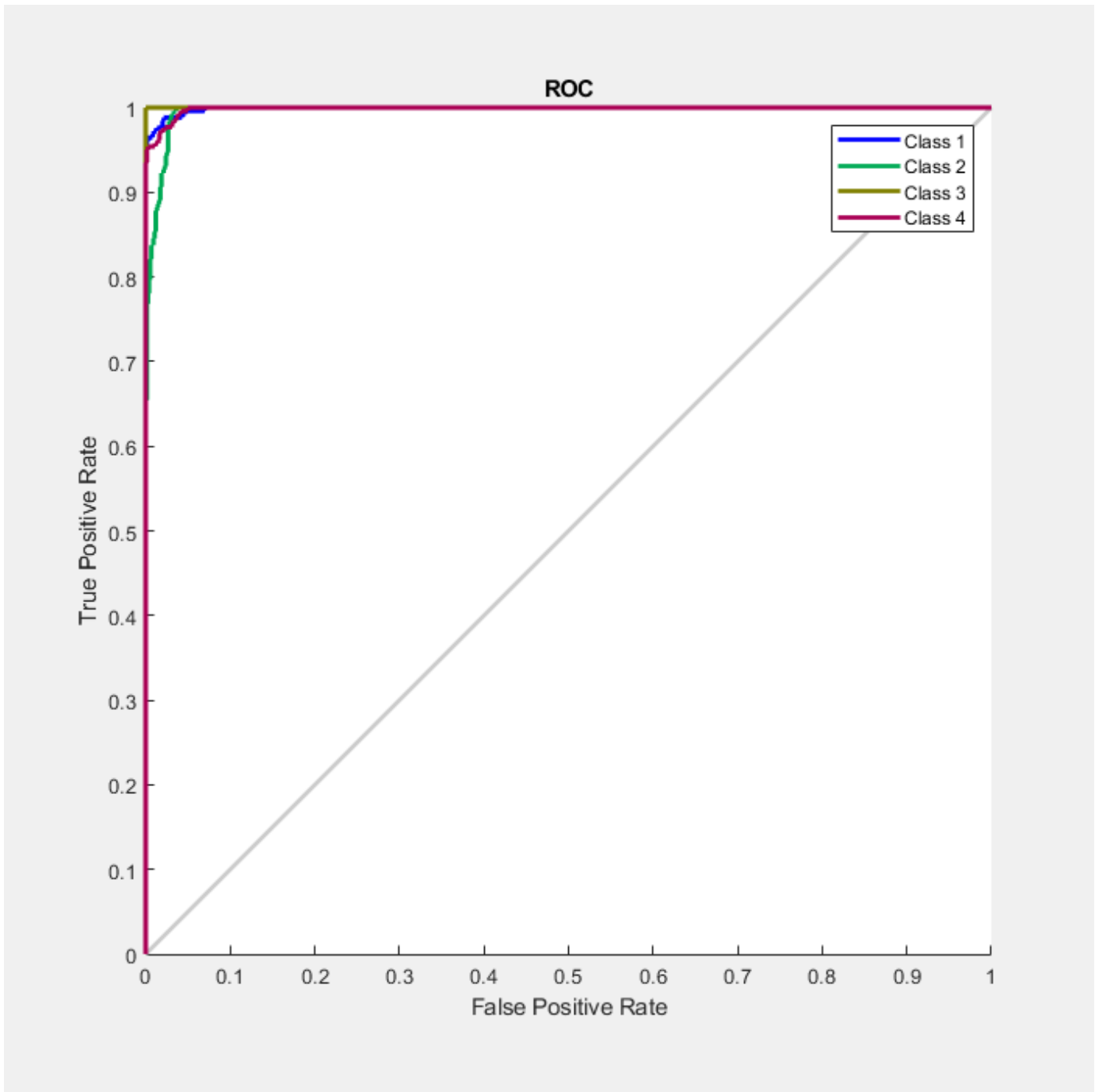

## See Also

roc

Introduced in R2008a

## plotsom

Plot self-organizing map

### Syntax

```
plotsom(pos)
plotsom(W,D,ND)
```

### Description

`plotsom(pos)` takes one argument,

POS	N-by-S matrix of S N-dimension neural positions
-----	---

and plots the neuron positions with red dots, linking the neurons within a Euclidean distance of 1.

`plotsom(W,D,ND)` takes three arguments,

W	S-by-R weight matrix
D	S-by-S distance matrix
ND	Neighborhood distance (default = 1)

and plots the neuron's weight vectors with connections between weight vectors whose neurons are within a distance of 1.

### Examples

#### Plot Self-Organizing Maps

These examples generate plots of various layer topologies.

```
pos = hextop([5 6]);
plotsom(pos)
```



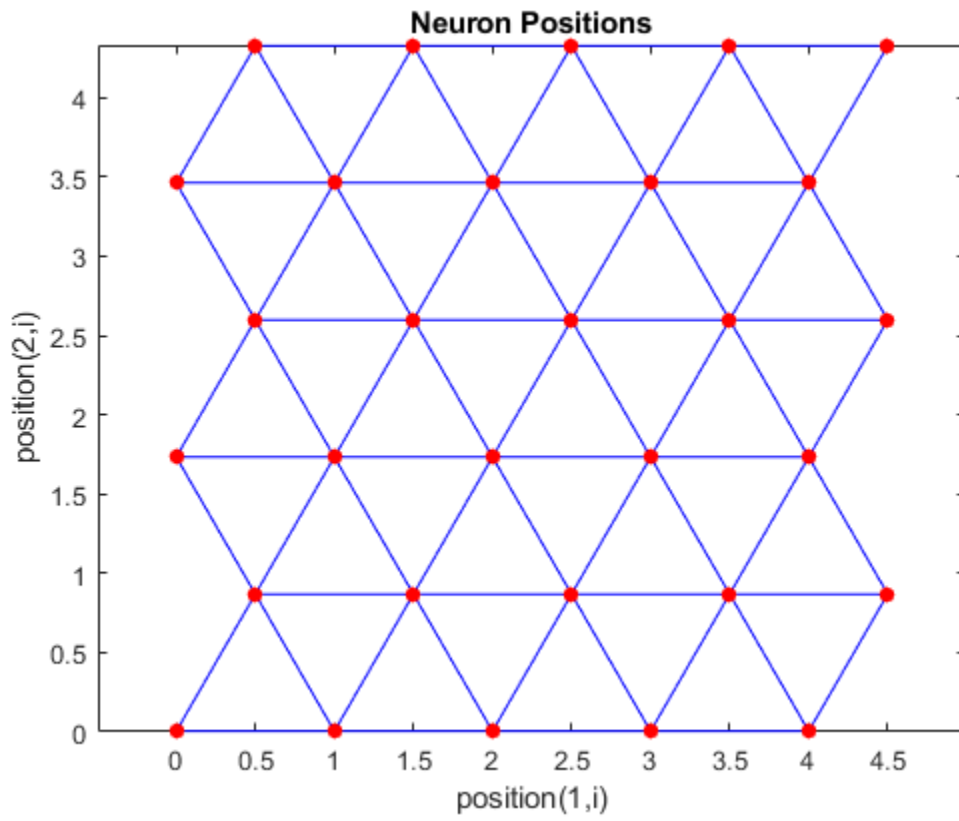

```
pos = gridtop([4 5]);  
plotsom(pos)
```

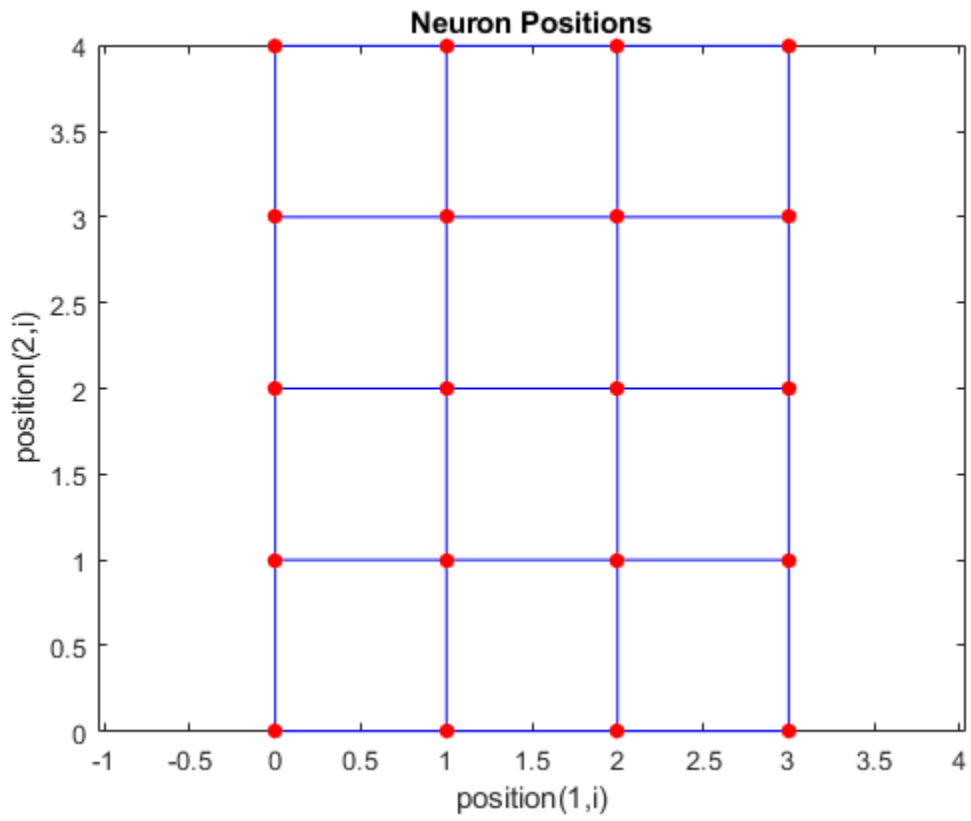

```
pos = randtop([18 12]);  
plotsom(pos)
```

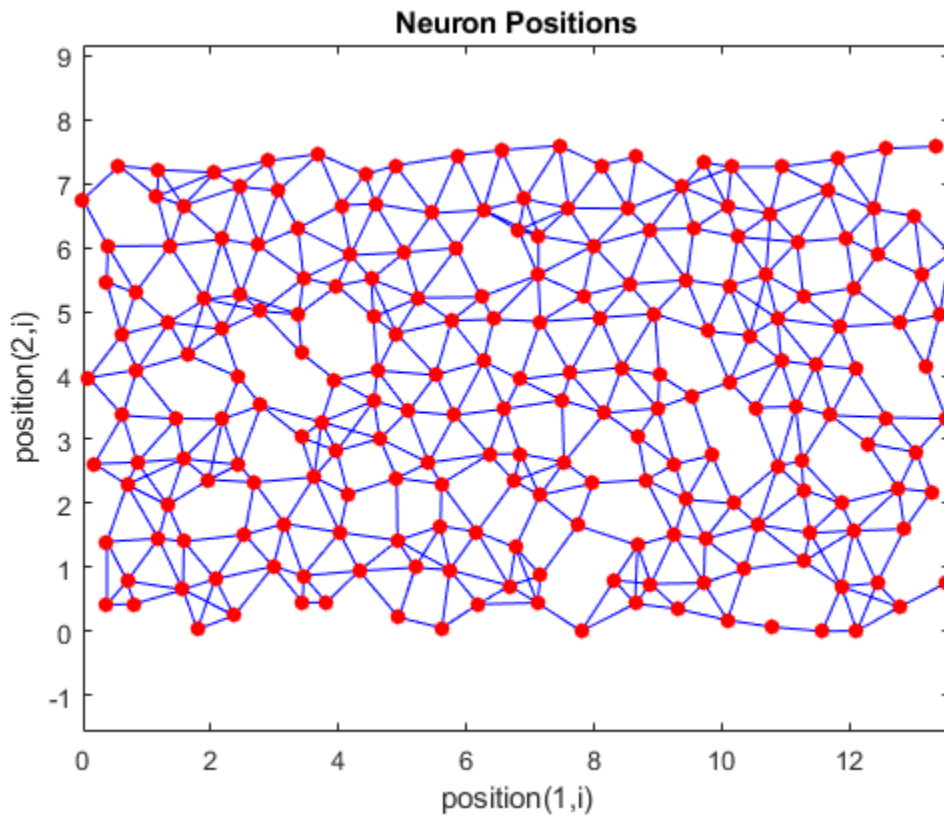

```
pos = gridtop([4 5 2]);  
plotsom(pos)
```

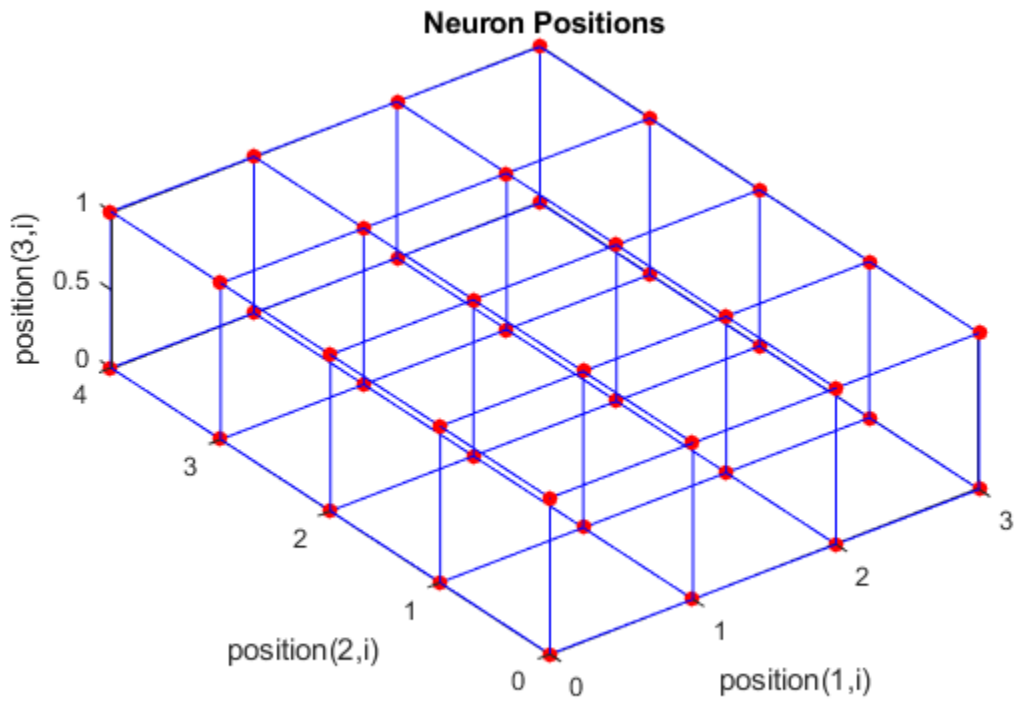

```
pos = hextop([4 4 3]);  
plotsom(pos)
```

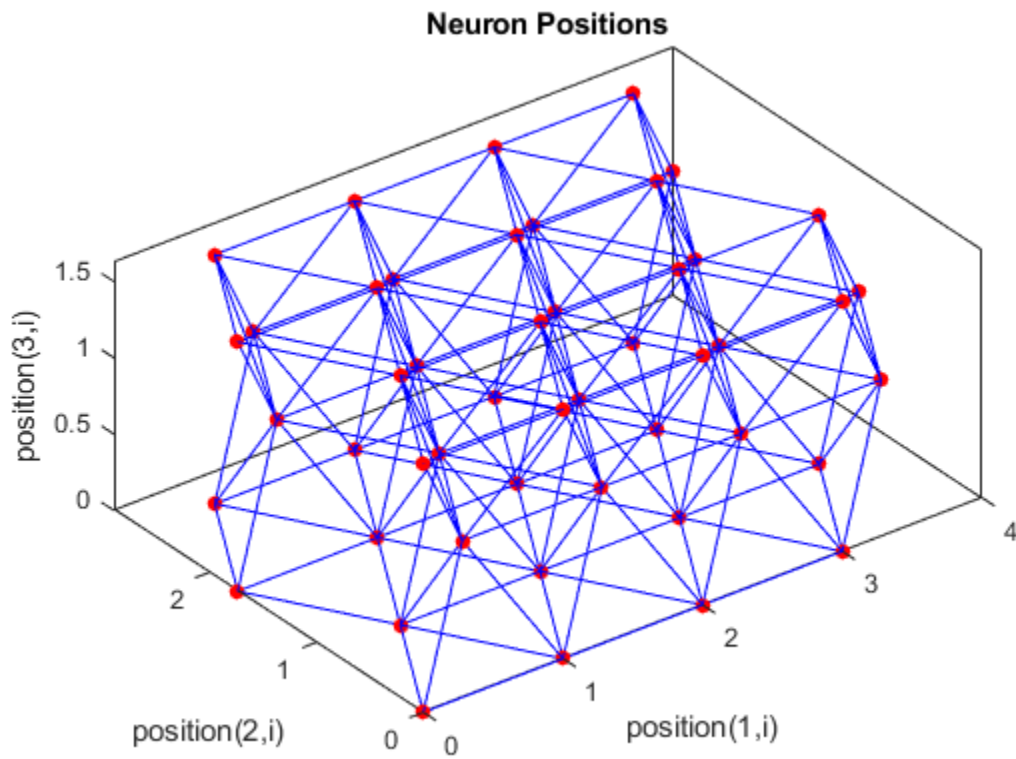

See `plotsompos` for an example of plotting a layer's weight vectors with the input vectors they map.

## See Also

`learnsom`

Introduced before R2006a

## plotsomhits

Plot self-organizing map sample hits

### Syntax

```
plotsomhits(net,inputs)
```

### Description

`plotsomhits(net,inputs)` plots a SOM layer, with each neuron showing the number of input vectors that it classifies. The relative number of vectors for each neuron is shown via the size of a colored patch.

This plot supports SOM networks with `hextop` and `gridtop` topologies, but not `tritop` or `randtop`.

### Examples

#### Plot SOM Sample Hits

```
x = iris_dataset;
net = selforgmap([5 5]);
net = train(net,x);
plotsomhits(net,x)
```

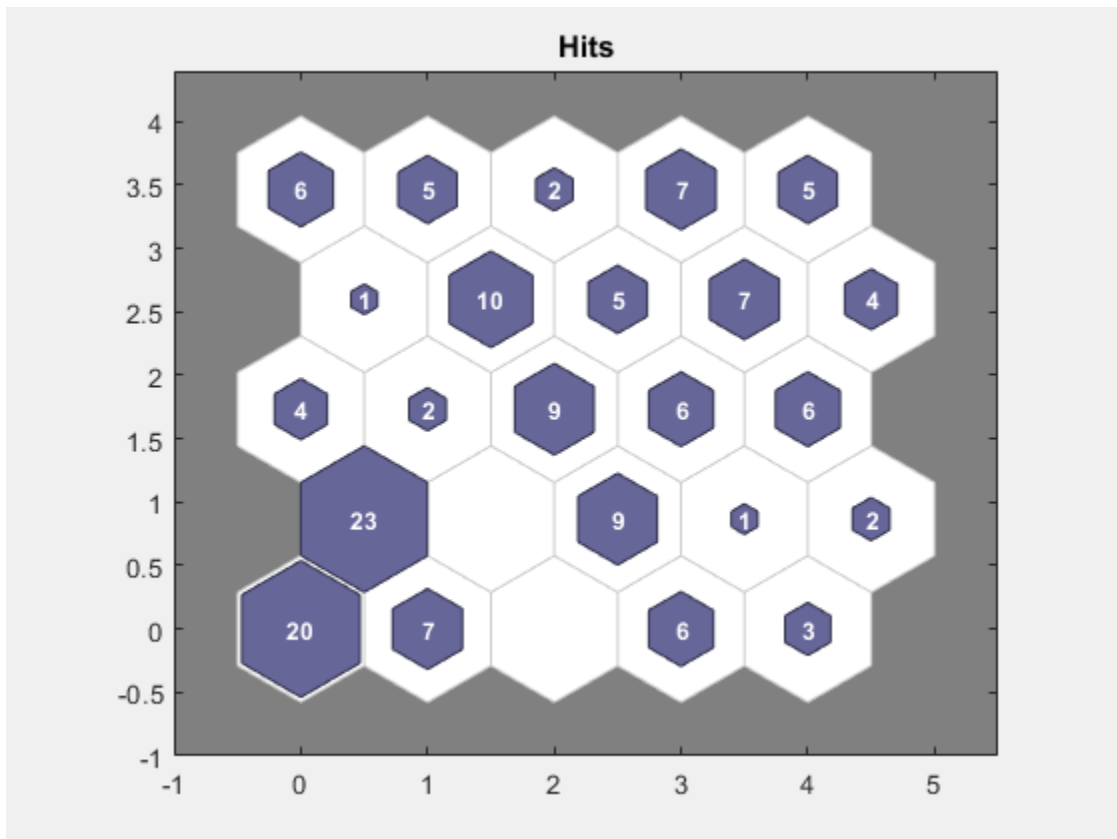

**See Also**

plotsomplanes

**Introduced in R2008a**

## plotsomnc

Plot self-organizing map neighbor connections

### Syntax

```
plotsomnc(net)
```

### Description

`plotsomnc(net)` plots a SOM layer showing neurons as gray-blue patches and their direct neighbor relations with red lines.

This plot supports SOM networks with `hextop` and `gridtop` topologies, but not `tritop` or `randtop`.

### Examples

#### Plot SOM Neighbor Connections

```
x = iris_dataset;
net = selforgmap([8 8]);
net = train(net,x);
plotsomnc(net)
```

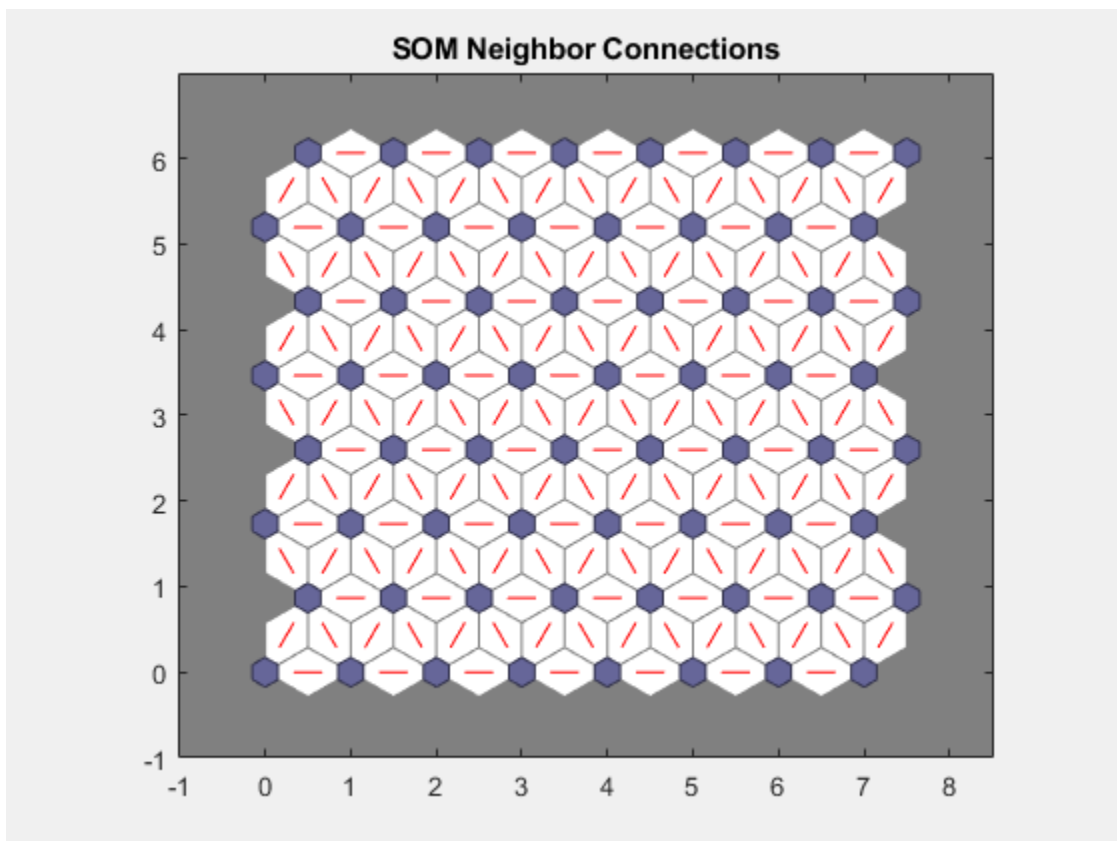



**See Also**

plotsomhits | plotsomnd | plotsomplanes

**Introduced in R2008a**

## plotsomnd

Plot self-organizing map neighbor distances

### Syntax

```
plotsomnd(net)
```

### Description

`plotsomnd(net)` plots a SOM layer showing neurons as gray-blue patches and their direct neighbor relations with red lines. The neighbor patches are colored from black to yellow to show how close each neuron's weight vector is to its neighbors.

This plot supports SOM networks with `hextop` and `gridtop` topologies, but not `tritop` or `randtop`.

### Examples

#### Plot SOM Neighbor Distances

```
x = iris_dataset;
net = selforgmap([5 5]);
net = train(net,x);
plotsomnd(net)
```

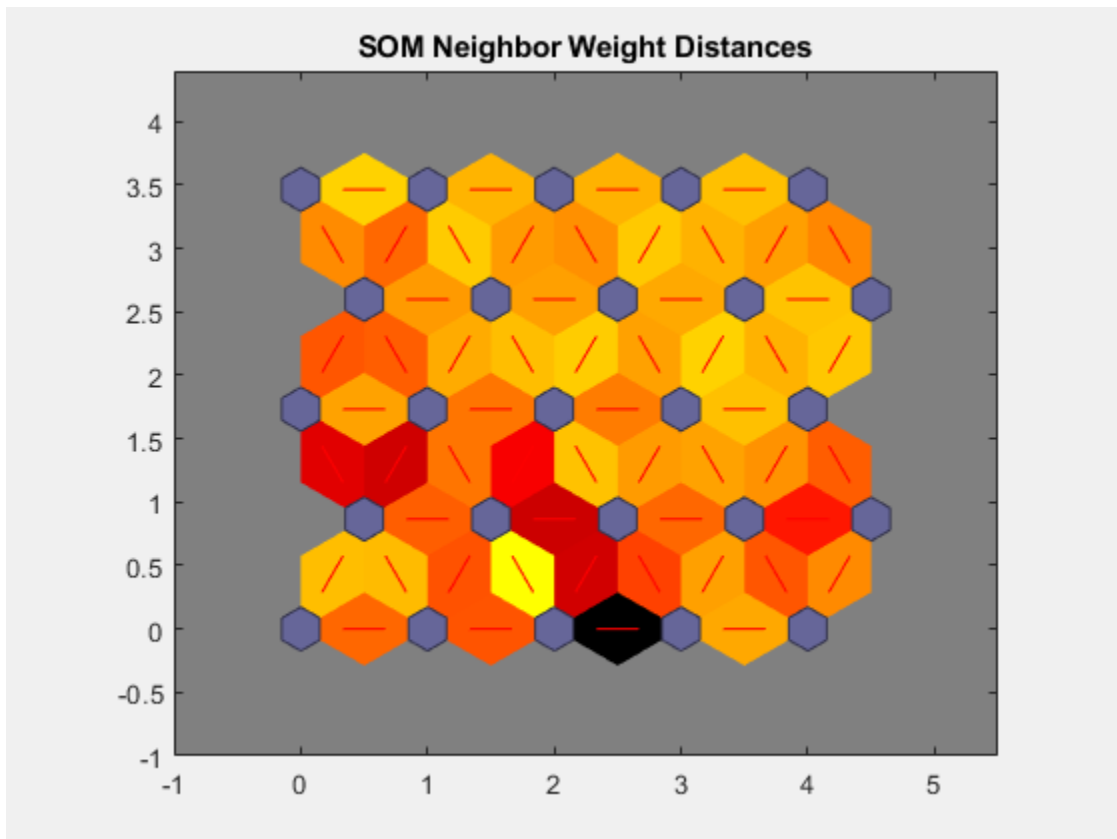

**See Also**

plotsomhits | plotsomnc | plotsomplanes

**Introduced in R2008a**

## plotsomplanes

Plot self-organizing map weight planes

### Syntax

```
plotsomplanes(net)
```

### Description

`plotsomplanes(net)` generates a set of subplots. Each *i*th subplot shows the weights from the *i*th input to the layer's neurons, with the most negative connections shown as black, zero connections as red, and the strongest positive connections as yellow.

The plot is only shown for layers organized in one or two dimensions.

This plot supports SOM networks with `hextop` and `gridtop` topologies, but not `tritop` or `randtop`.

This function can also be called with standardized plotting function arguments used by the function `train`.

### Examples

#### Plot SOM Weight Planes

```
x = iris_dataset;  
net = selforgmap([5 5]);  
net = train(net,x);  
plotsomplanes(net)
```

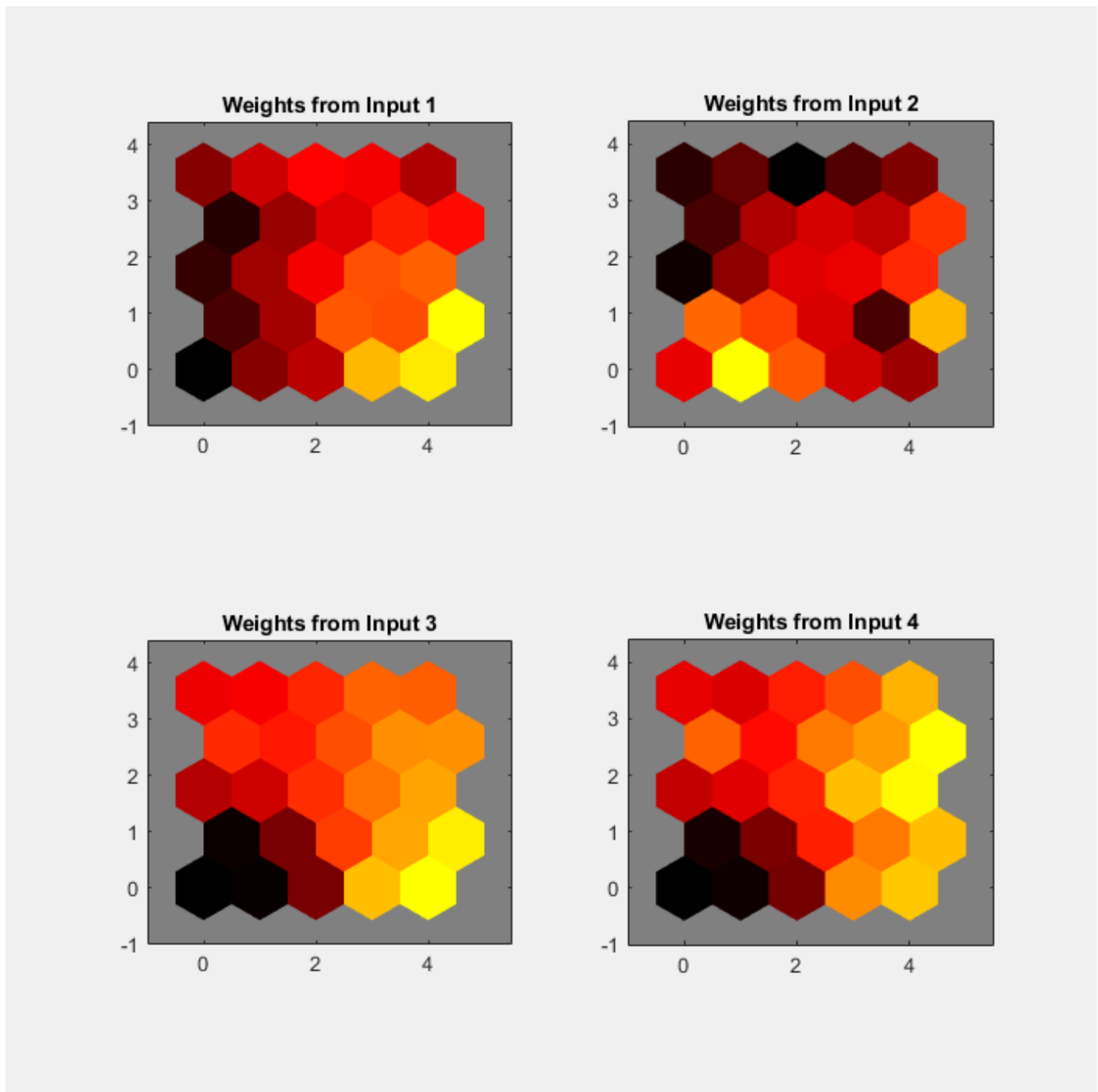
**See Also**

`plotsomhits` | `plotsomnc` | `plotsomnd`

**Introduced in R2008a**

## plotsompos

Plot self-organizing map weight positions

### Syntax

```
plotsompos(net)  
plotsompos(net,inputs)
```

### Description

`plotsompos(net)` plots the input vectors as green dots and shows how the SOM classifies the input space by showing blue-gray dots for each neuron's weight vector and connecting neighboring neurons with red lines.

`plotsompos(net,inputs)` plots the input data alongside the weights.

### Examples

#### Plot SOM Weight Positions

```
x = iris_dataset;  
net = selforgmap([10 10]);  
net = train(net,x);  
plotsompos(net,x)
```

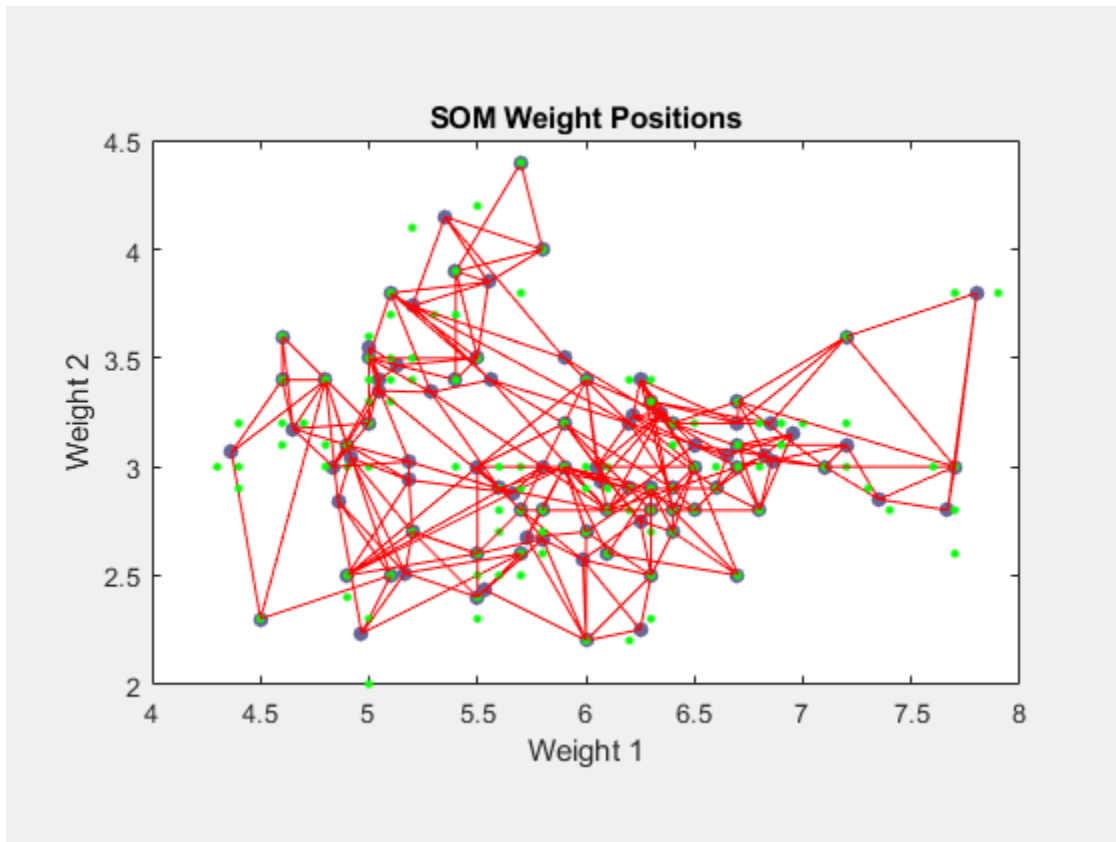
**See Also**

[plotsomhits](#) | [plotsomnd](#) | [plotsomplanes](#)

**Introduced in R2008a**

## plotsomtop

Plot self-organizing map topology

### Syntax

```
plotsomtop(net)
```

### Description

`plotsomtop(net)` plots the topology of a SOM layer.

This plot supports SOM networks with `hextop` and `gridtop` topologies, but not `tritop` or `randtop`.

### Examples

#### Plot SOM Topology

```
x = iris_dataset;  
net = selforgmap([8 8]);  
plotsomtop(net)
```

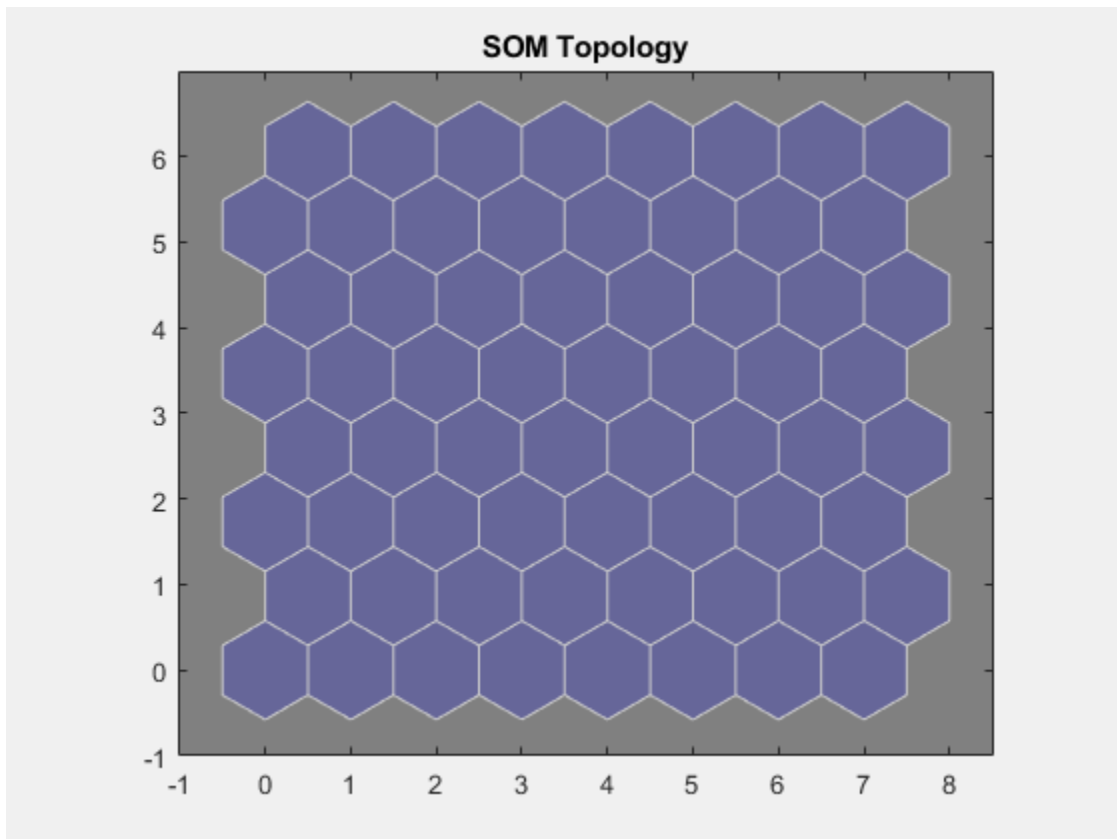



**See Also**

plotsomhits | plotsomnd | plotsomplanes

**Introduced in R2008a**

## plottrainstate

Plot training state values

### Syntax

```
plottrainstate(tr)
```

### Description

`plottrainstate(tr)` plots the training state from a training record `tr` returned by `train`.

### Examples

#### Plot Training State Values

This example shows how to plot training state values using `plottrainstate`.

```
[x, t] = bodyfat_dataset;
net = feedforwardnet(10);
[net, tr] = train(net, x, t);
plottrainstate(tr)
```

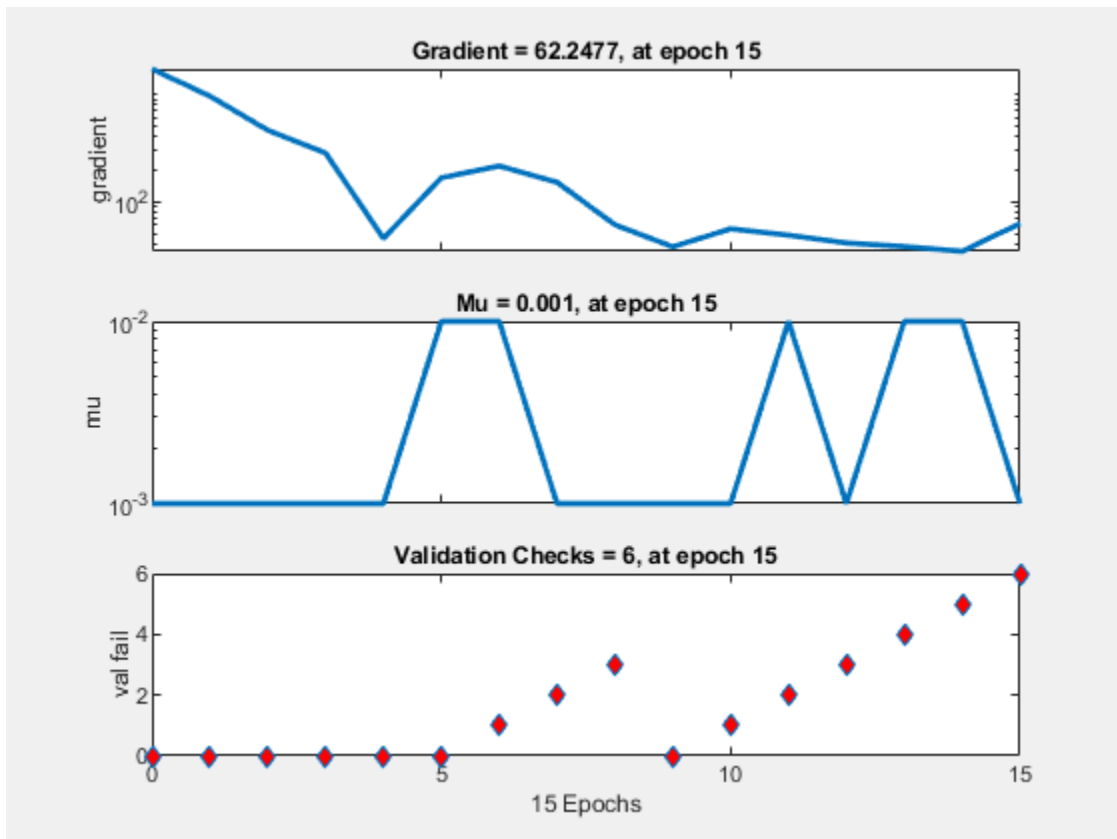

## **See Also**

plotfit | plotperform | plotregression

**Introduced in R2008a**

## plotv

Plot vectors as lines from origin

### Syntax

```
plotv(M,T)
```

### Description

plotv(M,T) takes two inputs,

M	R-by-Q matrix of Q column vectors with R elements
T	The line plotting type (optional; default = ' - ')

and plots the column vectors of M.

R must be 2 or greater. If R is greater than 2, only the first two rows of M are used for the plot.

### Examples

#### Plot Vectors

This example shows how to plot three 2-element vectors.

```
M = [-0.4 0.7 0.2 ; ...  
     -0.5 0.1 0.5];  
plotv(M, '-')
```

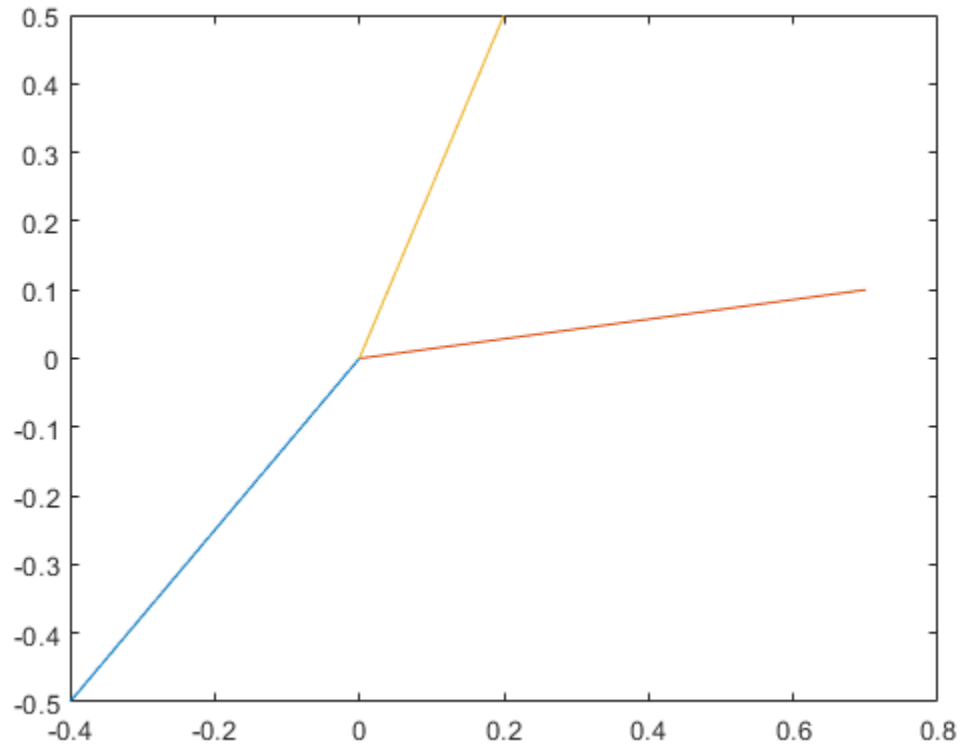

**Introduced before R2006a**

## plotvec

Plot vectors with different colors

### Syntax

```
plotvec(X,C,M)
```

### Description

`plotvec(X,C,M)` takes these inputs,

X	Matrix of (column) vectors
C	Row vector of color coordinates
M	Marker (default = '+' )

and plots each  $i$ th vector in  $X$  with a marker  $M$ , using the  $i$ th value in  $C$  as the color coordinate.

`plotvec(X)` only takes a matrix  $X$  and plots each  $i$ th vector in  $X$  with marker '+' using the index  $i$  as the color coordinate.

### Examples

#### Plot Vectors with Different Colors

This example shows how to plot four 2-element vectors.

```
x = [ 0 1 0.5 0.7 ; ...  
      -1 2 0.5 0.1];  
c = [1 2 3 4];  
plotvec(x,c)
```

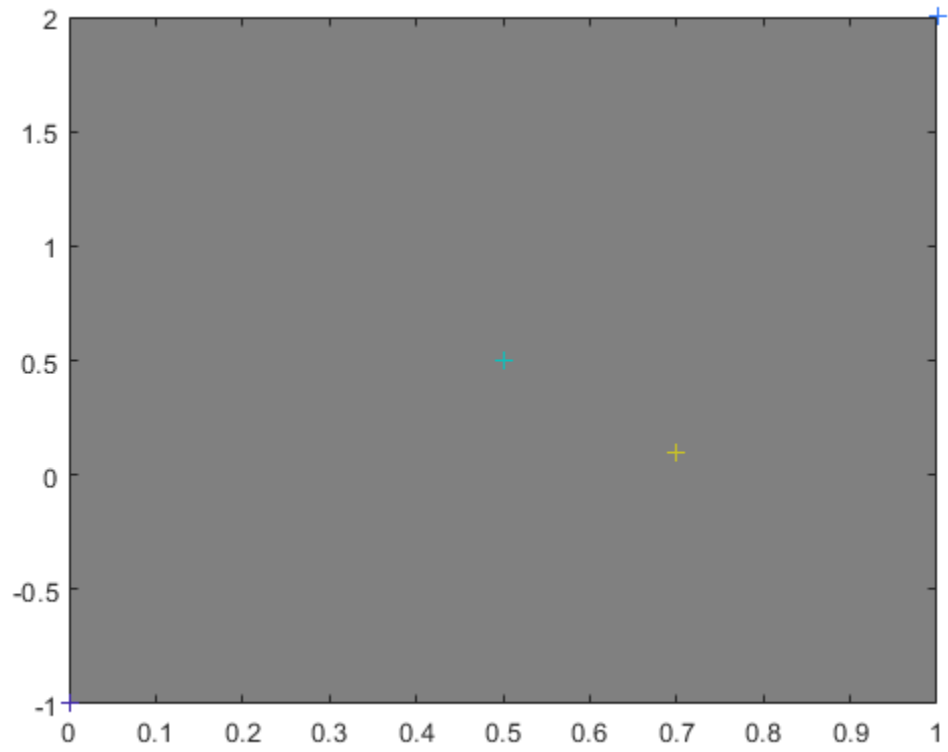

**Introduced before R2006a**

## plotwb

Plot Hinton diagram of weight and bias values

### Syntax

```
plotwb(net)
plotwb(IW,LW,B)
plotwb(...,'toLayers',toLayers)
plotwb(...,'fromInputs',fromInputs)
plotwb(...,'fromLayers',fromLayers)
plotwb(...,'root',root)
```

### Description

`plotwb(net)` takes a neural network and plots all its weights and biases.

`plotwb(IW,LW,B)` takes a neural networks input weights, layer weights and biases and plots them.

`plotwb(...,'toLayers',toLayers)` optionally defines which destination layers whose input weights, layer weights and biases will be plotted.

`plotwb(...,'fromInputs',fromInputs)` optionally defines which inputs will have their weights plotted.

`plotwb(...,'fromLayers',fromLayers)` optionally defines which layers will have weights coming from them plotted.

`plotwb(...,'root',root)` optionally defines the root used to scale the weight/bias patch sizes. The default is 2, which makes the 2-dimensional patch sizes scale directly with absolute weight and bias sizes. Larger values of root magnify the relative patch sizes of smaller weights and biases, making differences in smaller values easier to see.

### Examples

#### Plot Weights and Biases

Here a cascade-forward network is configured for particular data and its weights and biases are plotted in several ways.

```
[x,t] = simplefit_dataset;
net = cascadeforwardnet([15 5]);
net = configure(net,x,t);
plotwb(net)
```



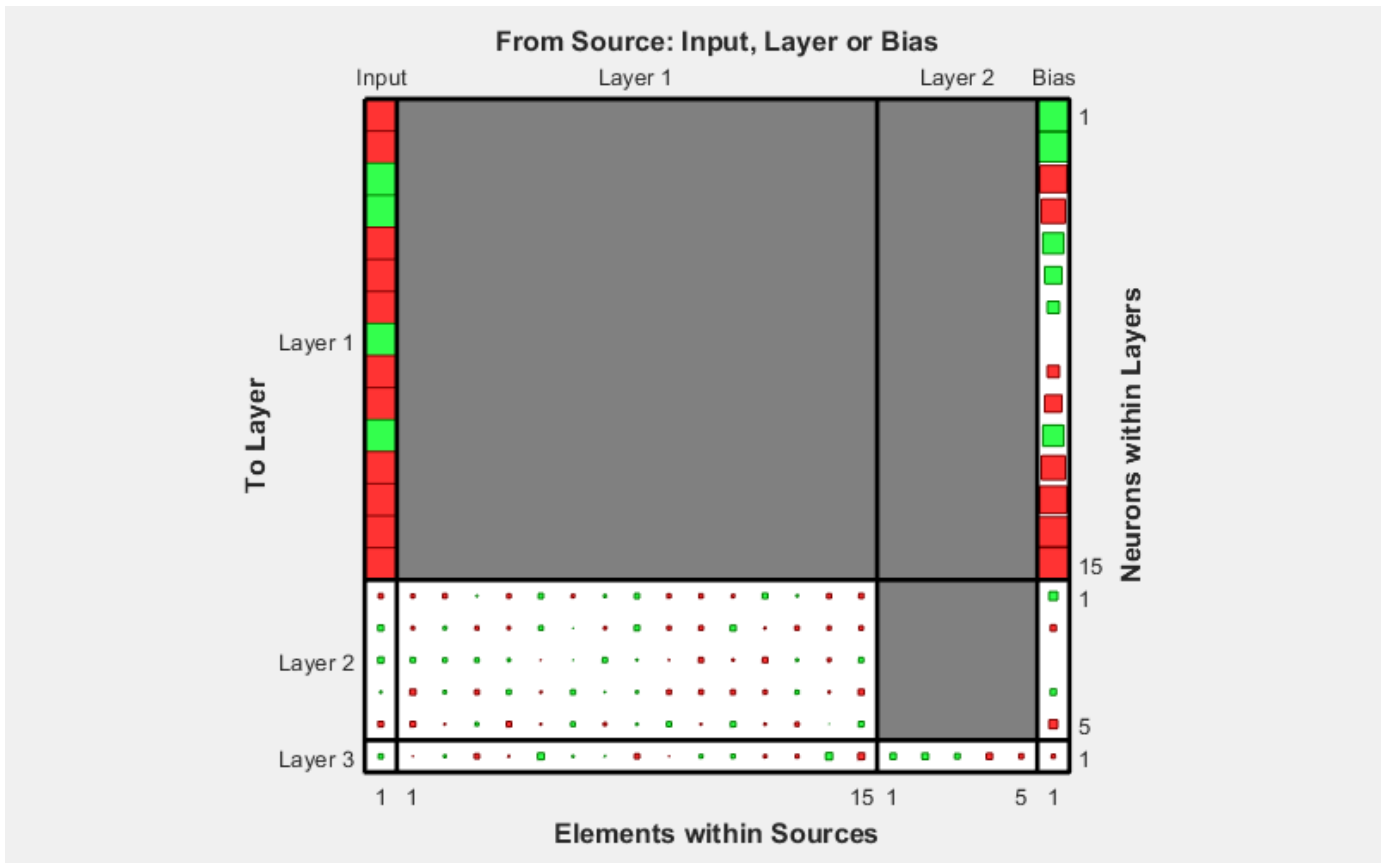

```
plotwb(net, 'root', 3)
```



plotwb(net, 'root', 4)

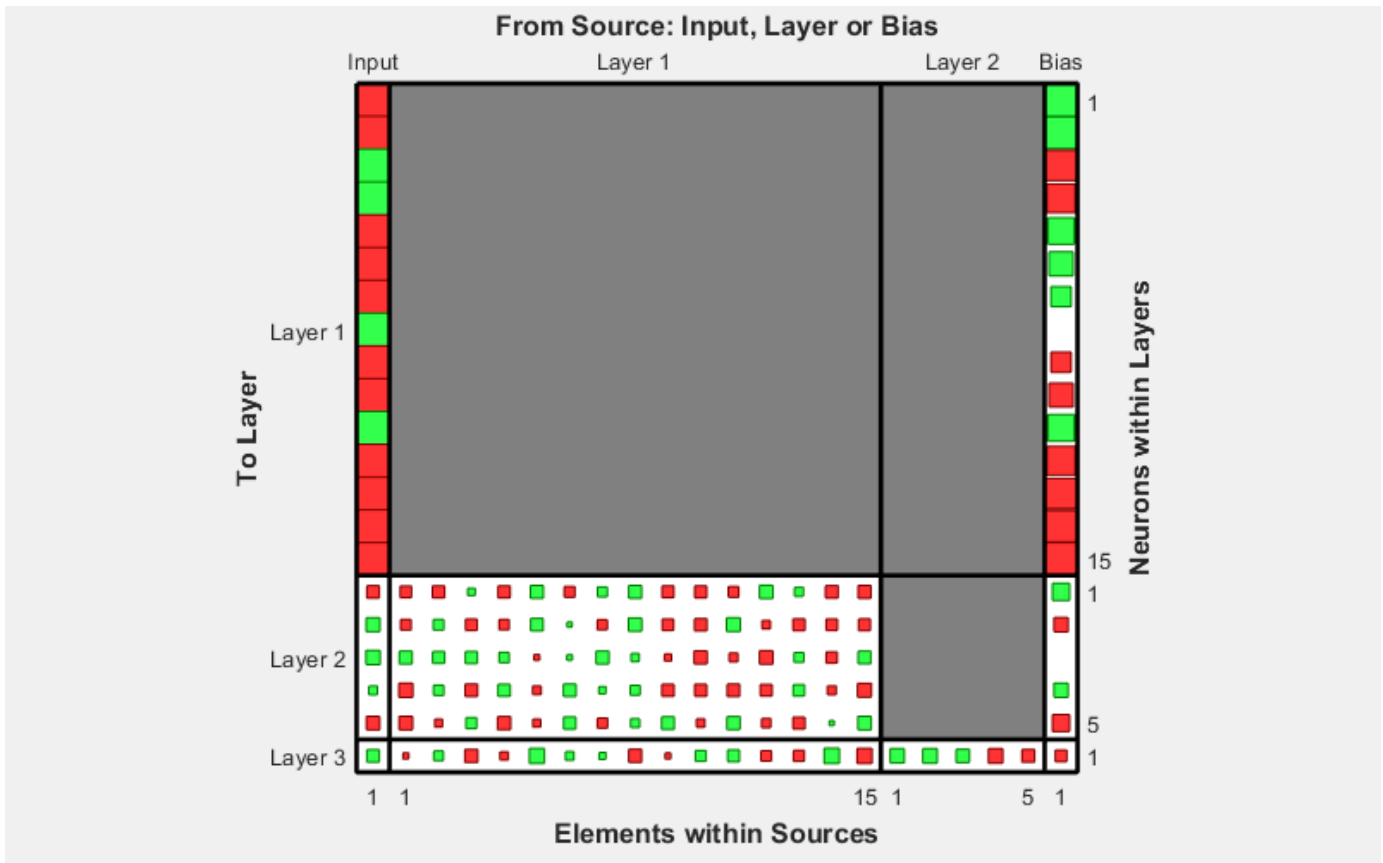

```
plotwb(net, 'toLayers', 2)
```

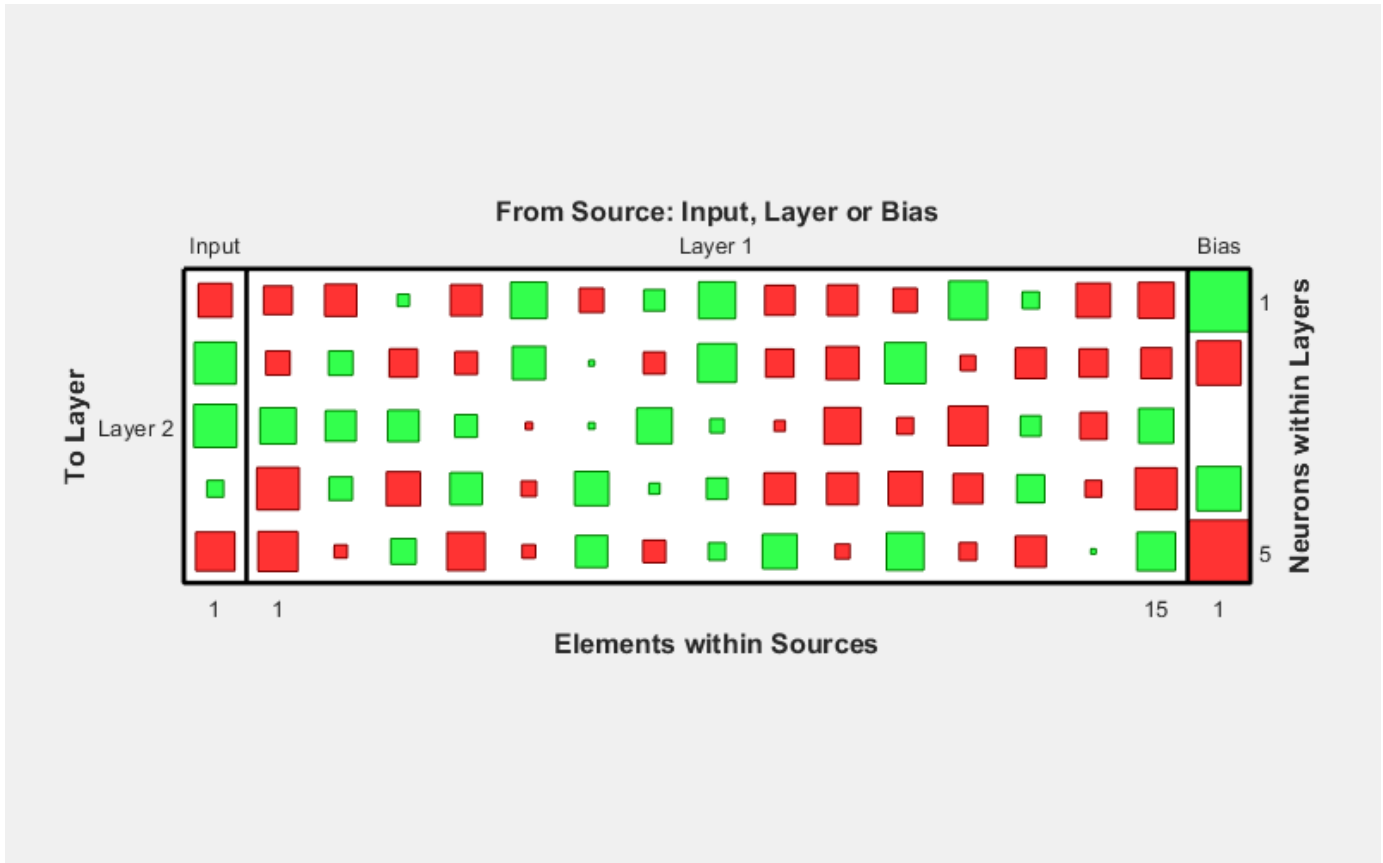

```
plotwb(net, 'fromLayers', 1)
```

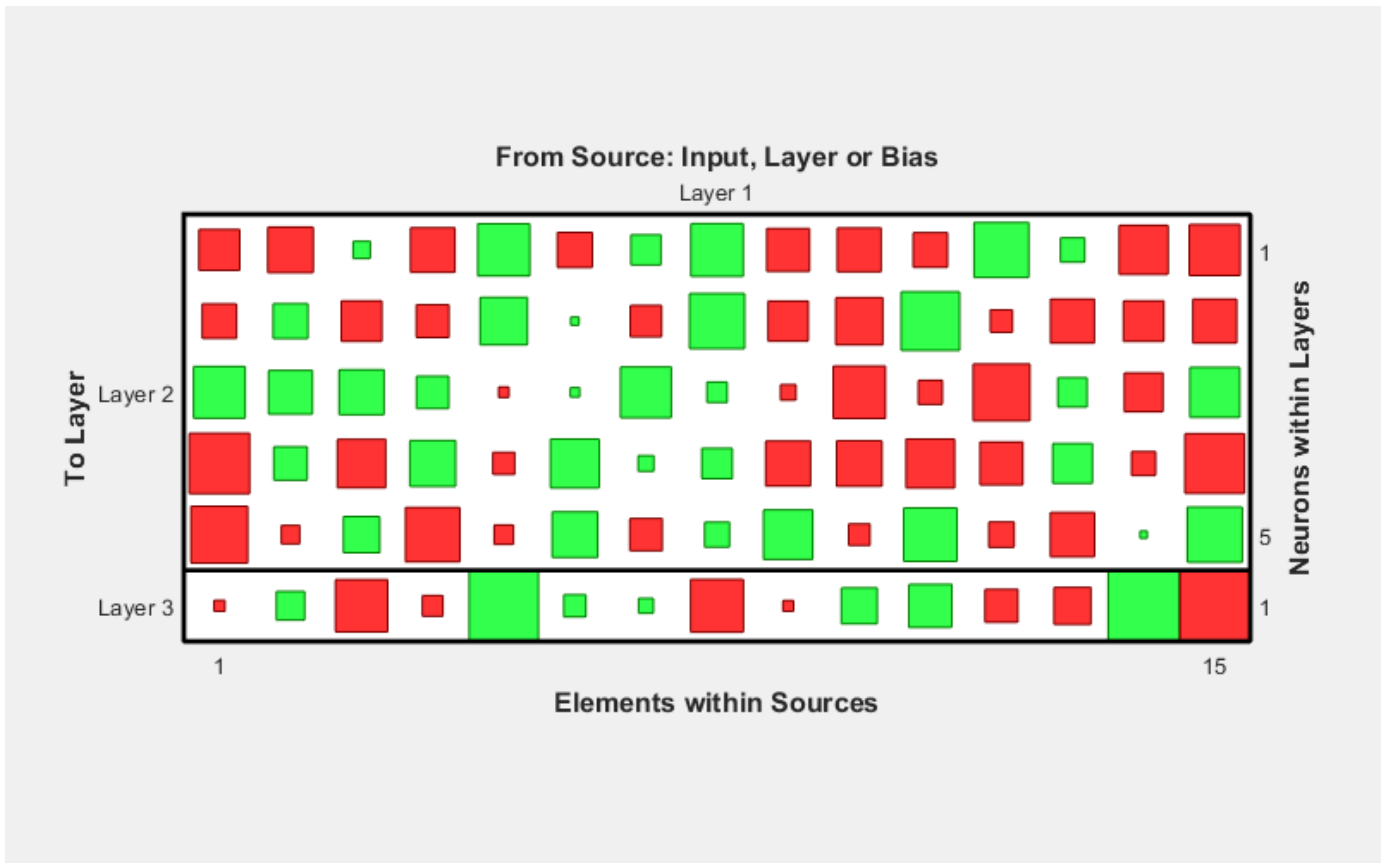

```
plotwb(net, 'toLayers', 2, 'fromInputs', 1)
```

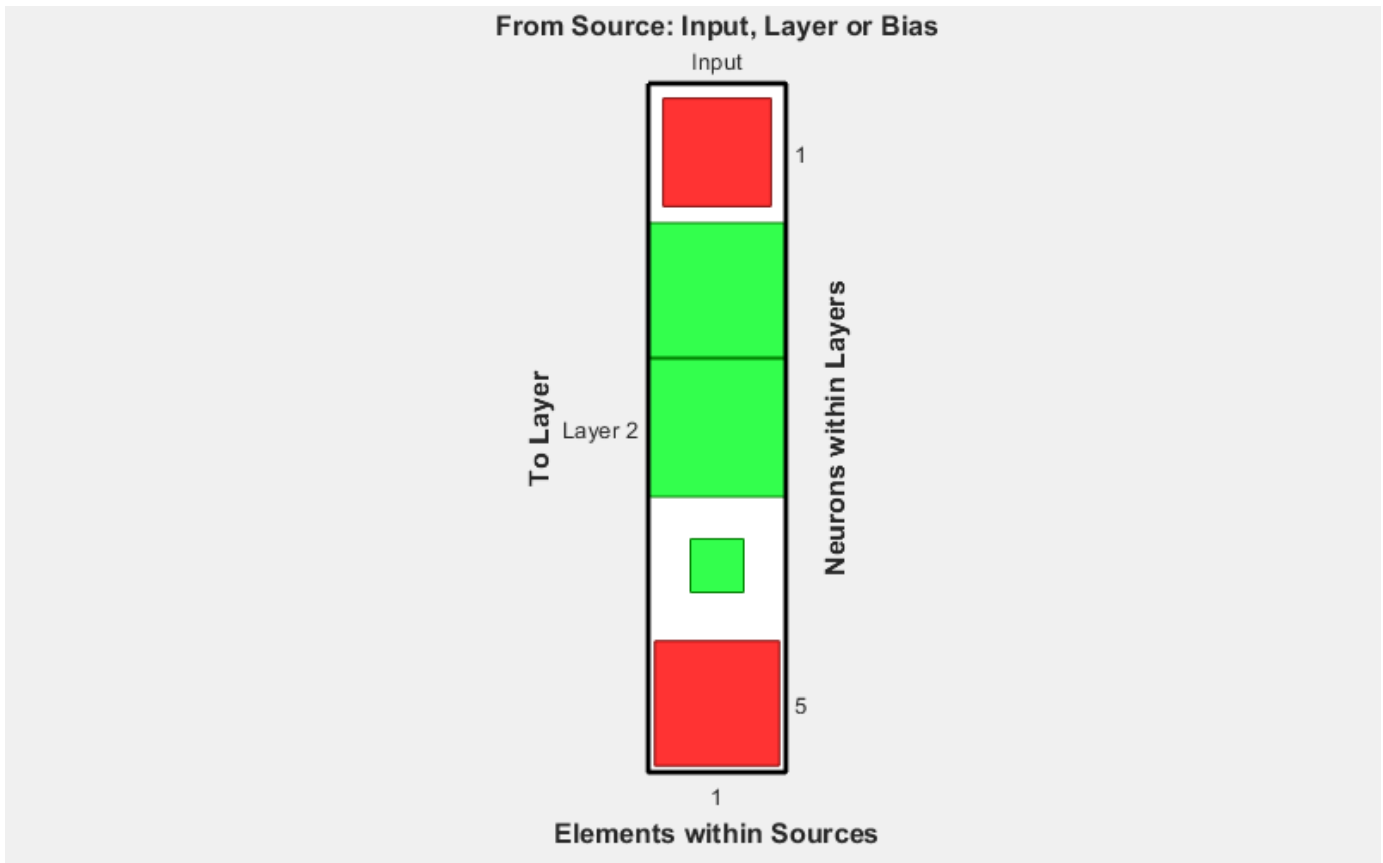

**See Also**  
plotsomplanes

**Introduced in R2010b**

## pnormc

Pseudonormalize columns of matrix

### Syntax

```
pnormc(X,R)
```

### Description

pnormc(X,R) takes these arguments,

X	M-by-N matrix
R	(Optional) radius to normalize columns to (default = 1)

and returns X with an additional row of elements, which results in new column vector lengths of R.

---

**Caution** For this function to work properly, the columns of X must originally have vector lengths less than R.

---

### Examples

```
x = [0.1 0.6; 0.3 0.1];  
y = pnormc(x)
```

### See Also

normc | normr

**Introduced before R2006a**

## poslin

Positive linear transfer function

### Graph and Symbol

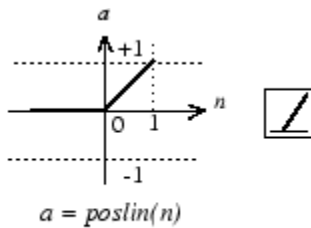

Positive Linear Transfer Function

### Syntax

```
A = poslin(N,FP)
info = poslin('code')
```

### Description

`poslin` is a neural transfer function. Transfer functions calculate a layer's output from its net input.

`A = poslin(N,FP)` takes `N` and optional function parameters,

N	S-by-Q matrix of net input (column) vectors
FP	Struct of function parameters (ignored)

and returns `A`, the S-by-Q matrix of `N`'s elements clipped to `[0, inf]`.

`info = poslin('code')` returns information about this function. The following codes are supported:

`poslin('name')` returns the name of this function.

`poslin('output',FP)` returns the `[min max]` output range.

`poslin('active',FP)` returns the `[min max]` active range.

`poslin('fullderiv')` returns 1 or 0, depending on whether `dA_dN` is S-by-S-by-Q or S-by-Q.

`poslin('fpnames')` returns the names of the function parameters.

`poslin('fpdefaults')` returns the default function parameters.

### Examples

Here is the code to create a plot of the `poslin` transfer function.



```
n = -5:0.1:5;  
a = poslin(n);  
plot(n,a)
```

Assign this transfer function to layer *i* of a network.

```
net.layers{i}.transferFcn = 'poslin';
```

## Network Use

To change a network so that a layer uses `poslin`, set `net.layers{i}.transferFcn` to `'poslin'`.

Call `sim` to simulate the network with `poslin`.

## Algorithms

The transfer function `poslin` returns the output *n* if *n* is greater than or equal to zero and 0 if *n* is less than or equal to zero.

$$\text{poslin}(n) = \begin{cases} n, & \text{if } n \geq 0 \\ 0, & \text{if } n < 0 \end{cases}$$

## See Also

`purelin` | `satlin` | `satlins` | `sim`

**Introduced before R2006a**

## preparets

Prepare input and target time series data for network simulation or training

### Syntax

```
[Xs,Xi,Ai,Ts,EWs,shift] = preparets(net,Xnf,Tnf,Tf,EW)
```

### Description

This function simplifies the normally complex and error prone task of reformatting input and target time series. It automatically shifts input and target time series as many steps as are needed to fill the initial input and layer delay states. If the network has open-loop feedback, then it copies feedback targets into the inputs as needed to define the open-loop inputs.

Each time a new network is designed, with different numbers of delays or feedback settings, `preparets` can reformat input and target data accordingly. Also, each time a network is transformed with `openloop`, `closeloop`, `removedelay` or `adddelay`, this function can reformat the data accordingly.

`[Xs,Xi,Ai,Ts,EWs,shift] = preparets(net,Xnf,Tnf,Tf,EW)` takes these arguments,

<code>net</code>	Neural network
<code>Xnf</code>	Non-feedback inputs
<code>Tnf</code>	Non-feedback targets
<code>Tf</code>	Feedback targets
<code>EW</code>	Error weights (default = {1})

and returns,

<code>Xs</code>	Shifted inputs
<code>Xi</code>	Initial input delay states
<code>Ai</code>	Initial layer delay states
<code>Ts</code>	Shifted targets
<code>EWs</code>	Shifted error weights
<code>shift</code>	The number of timesteps truncated from the front of X and T in order to properly fill Xi and Ai.

### Examples

#### Prepare Data for Open- and Closed-Loop Networks

Here a time-delay network with 20 hidden neurons is created, trained and simulated.

```
[X,T] = simpleseries_dataset;
net = timedelaynet(1:2,20);
[Xs,Xi,Ai,Ts] = preparets(net,X,T);
```

```
net = train(net,Xs,Ts);
view(net)
Y = net(Xs,Xi,Ai);
```

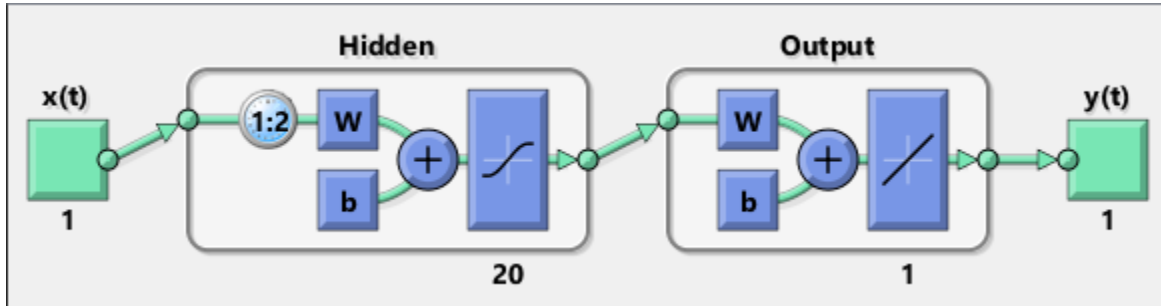

Here a NARX network is designed. The NARX network has a standard input and an open-loop feedback output to an associated feedback input.

```
[X,T] = simplenarx_dataset;
net = narxnet(1:2,1:2,20);
[Xs,Xi,Ai,Ts] = preparets(net,X,{},T);
net = train(net,Xs,Ts,Xi,Ai);
view(net)
y = net(Xs,Xi,Ai);
```

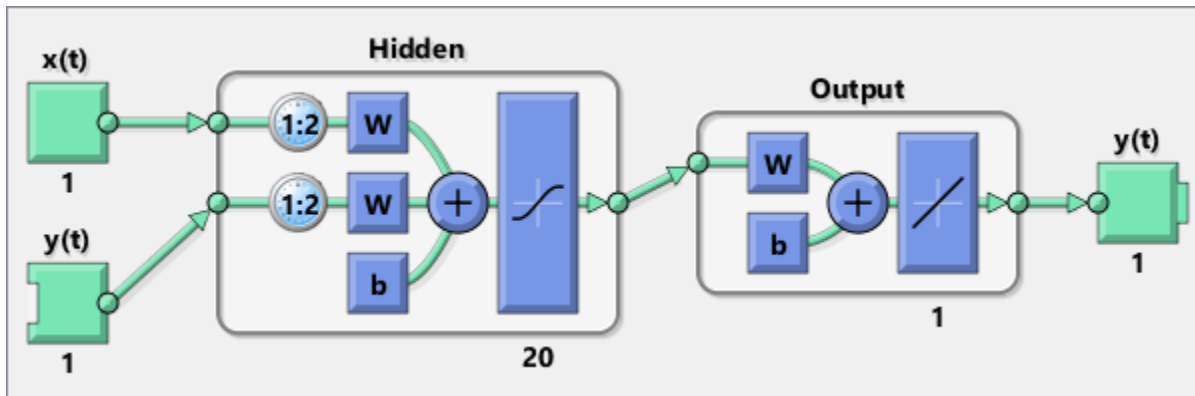

Now the network is converted to closed loop, and the data is reformatted to simulate the network's closed-loop response.

```
net = closeloop(net);
view(net)
[Xs,Xi,Ai] = preparets(net,X,{},T);
y = net(Xs,Xi,Ai);
```

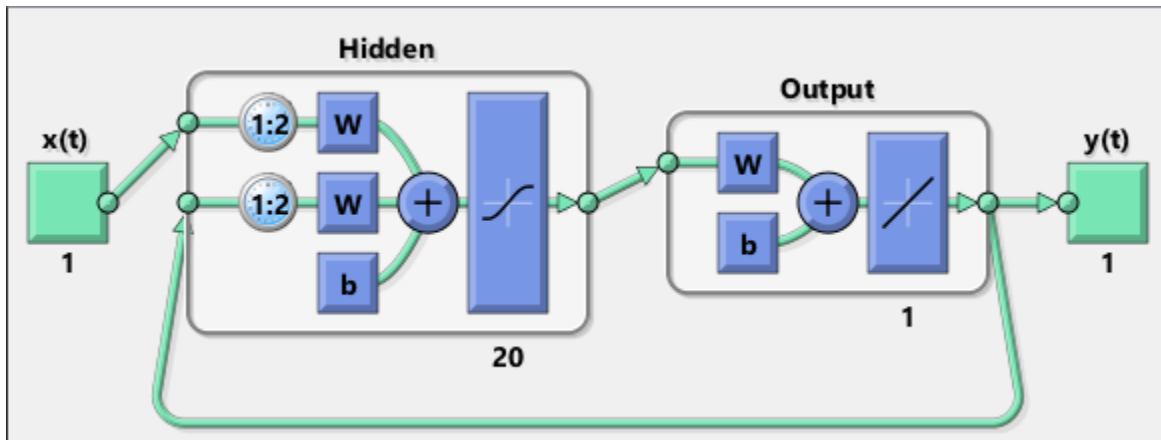

**See Also**

`adddelay` | `closeloop` | `narnet` | `narxnet` | `openloop` | `removedelay` | `timedelaynet`

**Introduced in R2010b**

## processpca

Process columns of matrix with principal component analysis

### Syntax

```
[Y,PS] = processpca(X,maxfrac)
[Y,PS] = processpca(X,FP)
Y = processpca('apply',X,PS)
X = processpca('reverse',Y,PS)
name = processpca('name')
fp = processpca('pdefaults')
names = processpca('pdesc')
processpca('pcheck',fp);
```

### Description

`processpca` processes matrices using principal component analysis so that each row is uncorrelated, the rows are in the order of the amount they contribute to total variation, and rows whose contribution to total variation are less than `maxfrac` are removed.

`[Y,PS] = processpca(X,maxfrac)` takes `X` and an optional parameter,

X	N-by-Q matrix
maxfrac	Maximum fraction of variance for removed rows (default is 0)

and returns

Y	M-by-Q matrix with N - M rows deleted
PS	Process settings that allow consistent processing of values

`[Y,PS] = processpca(X,FP)` takes parameters as a struct: `FP.maxfrac`.

`Y = processpca('apply',X,PS)` returns `Y`, given `X` and settings `PS`.

`X = processpca('reverse',Y,PS)` returns `X`, given `Y` and settings `PS`.

`name = processpca('name')` returns the name of this process method.

`fp = processpca('pdefaults')` returns default process parameter structure.

`names = processpca('pdesc')` returns the process parameter descriptions.

`processpca('pcheck',fp);` throws an error if any parameter is illegal.

### Examples

Here is how to format a matrix with an independent row, a correlated row, and a completely redundant row so that its rows are uncorrelated and the redundant row is dropped.

```
x1_independent = rand(1,5)
x1_correlated = rand(1,5) + x1_independent;
x1_redundant = x1_independent + x1_correlated
x1 = [x1_independent; x1_correlated; x1_redundant]
[y1,ps] = processpca(x1)
```

Next, apply the same processing settings to new values.

```
x2_independent = rand(1,5)
x2_correlated = rand(1,5) + x1_independent;
x2_redundant = x1_independent + x1_correlated
x2 = [x2_independent; x2_correlated; x2_redundant];
y2 = processpca('apply',x2,ps)
```

Reverse the processing of y1 to get x1 again.

```
x1_again = processpca('reverse',y1,ps)
```

## More About

### Reduce Input Dimensionality Using processpca

In some situations, the dimension of the input vector is large, but the components of the vectors are highly correlated (redundant). It is useful in this situation to reduce the dimension of the input vectors. An effective procedure for performing this operation is principal component analysis. This technique has three effects: it orthogonalizes the components of the input vectors (so that they are uncorrelated with each other), it orders the resulting orthogonal components (principal components) so that those with the largest variation come first, and it eliminates those components that contribute the least to the variation in the data set. The following code illustrates the use of `processpca`, which performs a principal-component analysis using the processing setting `maxfrac` of `0.02`.

```
[pn,ps1] = mapstd(p);
[ptrans,ps2] = processpca(pn,0.02);
```

The input vectors are first normalized, using `mapstd`, so that they have zero mean and unity variance. This is a standard procedure when using principal components. In this example, the second argument passed to `processpca` is `0.02`. This means that `processpca` eliminates those principal components that contribute less than 2% to the total variation in the data set. The matrix `ptrans` contains the transformed input vectors. The settings structure `ps2` contains the principal component transformation matrix. After the network has been trained, these settings should be used to transform any future inputs that are applied to the network. It effectively becomes a part of the network, just like the network weights and biases. If you multiply the normalized input vectors `pn` by the transformation matrix `transMat`, you obtain the transformed input vectors `ptrans`.

If `processpca` is used to preprocess the training set data, then whenever the trained network is used with new inputs, you should preprocess them with the transformation matrix that was computed for the training set, using `ps2`. The following code applies a new set of inputs to a network already trained.

```
pnewn = mapstd('apply',pnew,ps1);
pnewtrans = processpca('apply',pnewn,ps2);
a = sim(net,pnewtrans);
```

Principal component analysis is not reliably reversible. Therefore it is only recommended for input processing. Outputs require reversible processing functions.

Principal component analysis is not part of the default processing for `feedforwardnet`. You can add this with the following command:

```
net.inputs{1}.processFcns{end+1} = 'processpca';
```

## Algorithms

Values in rows whose elements are not all the same value are set to

$$y = 2*(x-\min x)/(\max x-\min x) - 1;$$

Values in rows with all the same value are set to 0.

## See Also

`fixunknowns` | `mapminmax` | `mapstd`

**Introduced in R2006a**

## prune

Delete neural inputs, layers, and outputs with sizes of zero

### Syntax

```
[net,pi,pl,po] = prune(net)
```

### Description

This function removes zero-sized inputs, layers, and outputs from a network. This leaves a network which may have fewer inputs and outputs, but which implements the same operations, as zero-sized inputs and outputs do not convey any information.

One use for this simplification is to prepare a network with zero sized subobjects for Simulink, where zero sized signals are not supported.

The companion function `prunedata` can prune data to remain consistent with the transformed network.

`[net,pi,pl,po] = prune(net)` takes a neural network and returns

<code>net</code>	The same network with zero-sized subobjects removed
<code>pi</code>	Indices of pruned inputs
<code>pl</code>	Indices of pruned layers
<code>po</code>	Indices of pruned outputs

### Examples

Here a NARX dynamic network is created which has one external input and a second input which feeds back from the output.

```
net = narxnet(20);
view(net)
```

The network is then trained on a single random time-series problem with 50 timesteps. The external input happens to have no elements.

```
X = nndata(0,1,50);
T = nndata(1,1,50);
[Xs,Xi,Ai,Ts] = preparets(net,X,{},T);
net = train(net,Xs,Ts);
```

The network and data are then pruned before generating a Simulink diagram and initializing its input and layer states.

```
[net2,pi,pl,po] = prune(net);
view(net)
[Xs2,Xi2,Ai2,Ts2] = prunedata(net,pi,pl,po,Xs,Xi,Ai,Ts)
[sysName,netName] = gensim(net);
setsiminit(sysName,netName,Xi2,Ai2)
```



## **See Also**

gensim | prunedata

**Introduced in R2010b**

## prunedata

Prune data for consistency with pruned network

### Syntax

```
[Xp,Xip,Aip,Tp] = prunedata(pi,pl,po,X,Xi,Ai,T)
```

### Description

This function prunes data to be consistent with a network whose zero-sized inputs, layers, and outputs have been removed with `prune`.

One use for this simplification is to prepare a network with zero-sized subobjects for Simulink, where zero-sized signals are not supported.

`[Xp,Xip,Aip,Tp] = prunedata(pi,pl,po,X,Xi,Ai,T)` takes these arguments,

<code>pi</code>	Indices of pruned inputs
<code>pl</code>	Indices of pruned layers
<code>po</code>	Indices of pruned outputs
<code>X</code>	Input data
<code>Xi</code>	Initial input delay states
<code>Ai</code>	Initial layer delay states
<code>T</code>	Target data

and returns the pruned inputs, input and layer delay states, and targets.

### Examples

Here a NARX dynamic network is created which has one external input and a second input which feeds back from the output.

```
net = narxnet(20);
view(net)
```

The network is then trained on a single random time-series problem with 50 timesteps. The external input happens to have no elements.

```
X = nndata(0,1,50);
T = nndata(1,1,50);
[Xs,Xi,Ai,Ts] = preparets(net,X,{},T);
net = train(net,Xs,Ts);
```

The network and data are then pruned before generating a Simulink diagram and initializing its input and layer states.

```
[net2,pi,pl,po] = prune(net);
view(net)
```

```
[Xs2,Xi2,Ai2,Ts2] = prunedata(net,pi,pl,po,Xs,Xi,Ai,Ts)
[sysName,netName] = gensim(net);
setsiminit(sysName,netName,Xi2,Ai2)
```

## **See Also**

gensim | prune

**Introduced in R2010b**

## purelin

Linear transfer function

### Graph and Symbol

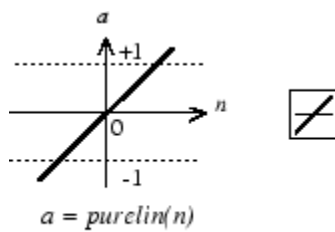

Linear Transfer Function

### Syntax

```
A = purelin(N,FP)
info = purelin('code')
```

### Description

`purelin` is a neural transfer function. Transfer functions calculate a layer's output from its net input.

`A = purelin(N,FP)` takes `N` and optional function parameters,

N	S-by-Q matrix of net input (column) vectors
FP	Struct of function parameters (ignored)

and returns `A`, an S-by-Q matrix equal to `N`.

`info = purelin('code')` returns useful information for each supported `code` character vector:

`purelin('name')` returns the name of this function.

`purelin('output',FP)` returns the [min max] output range.

`purelin('active',FP)` returns the [min max] active input range.

`purelin('fullderiv')` returns 1 or 0, depending on whether `dA_dN` is S-by-S-by-Q or S-by-Q.

`purelin('fpnames')` returns the names of the function parameters.

`purelin('fpdefaults')` returns the default function parameters.

### Examples

Here is the code to create a plot of the `purelin` transfer function.

```
n = -5:0.1:5;  
a = purelin(n);  
plot(n,a)
```

Assign this transfer function to layer *i* of a network.

```
net.layers{i}.transferFcn = 'purelin';
```

## Algorithms

```
a = purelin(n) = n
```

## See Also

[satlin](#) | [satlins](#) | [sim](#)

**Introduced before R2006a**

## quant

Discretize values as multiples of quantity

### Syntax

```
quant(X,Q)
```

### Description

quant(X,Q) takes two inputs,

X	Matrix, vector, or scalar
Q	Minimum value

and returns values from X rounded to nearest multiple of Q.

### Examples

```
x = [1.333 4.756 -3.897];  
y = quant(x,0.1)
```

**Introduced before R2006a**

# radbas

Radial basis transfer function

## Graph and Symbol

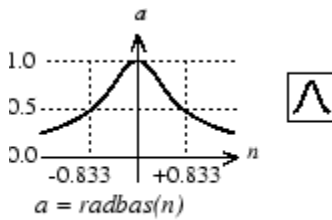

Radial Basis Function

## Syntax

$A = \text{radbas}(N, FP)$

## Description

radbas is a neural transfer function. Transfer functions calculate a layer's output from its net input.

$A = \text{radbas}(N, FP)$  takes one or two inputs,

N	S-by-Q matrix of net input (column) vectors
FP	Struct of function parameters (ignored)

and returns A, an S-by-Q matrix of the radial basis function applied to each element of N.

## Examples

Here you create a plot of the radbas transfer function.

```
n = -5:0.1:5;
a = radbas(n);
plot(n,a)
```

Assign this transfer function to layer i of a network.

```
net.layers{i}.transferFcn = 'radbas';
```

## Algorithms

$a = \text{radbas}(n) = \exp(-n^2)$

## See Also

radbasn | sim | tribas

**Introduced before R2006a**



# radbasn

Normalized radial basis transfer function

## Graph and Symbol

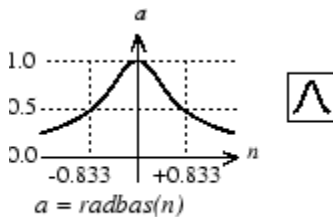

Radial Basis Function

## Syntax

$A = \text{radbasn}(N, FP)$

## Description

radbasn is a neural transfer function. Transfer functions calculate a layer's output from its net input. This function is equivalent to radbas, except that output vectors are normalized by dividing by the sum of the pre-normalized values.

$A = \text{radbasn}(N, FP)$  takes one or two inputs,

N	S-by-Q matrix of net input (column) vectors
FP	Struct of function parameters (ignored)

and returns A, an S-by-Q matrix of the radial basis function applied to each element of N.

## Examples

Here six random 3-element vectors are passed through the radial basis transform and normalized.

```
n = rand(3,6)
a = radbasn(n)
```

Assign this transfer function to layer i of a network.

```
net.layers{i}.transferFcn = 'radbasn';
```

## Algorithms

$$a = \text{radbasn}(n) = \frac{\exp(-n^2)}{\sum(\exp(-n^2))}$$

## See Also

radbas | sim | tribas

**Introduced in R2010b**

## randnc

Normalized column weight initialization function

### Syntax

`W = randnc(S,PR)`

### Description

randnc is a weight initialization function.

`W = randnc(S,PR)` takes two inputs,

S	Number of rows (neurons)
PR	R-by-2 matrix of input value ranges = [Pmin Pmax]

and returns an S-by-R random matrix with normalized columns.

You can also call this in the form `randnc(S,R)`.

### Examples

A random matrix of four normalized three-element columns is generated:

`M = randnc(3,4)`

M =

-0.6007	-0.4715	-0.2724	0.5596
-0.7628	-0.6967	-0.9172	0.7819
-0.2395	0.5406	-0.2907	0.2747

### See Also

randnr

**Introduced before R2006a**

## randnr

Normalized row weight initialization function

### Syntax

```
W = randnr(S,PR)
```

### Description

randnr is a weight initialization function.

W = randnr(S, PR) takes two inputs,

S	Number of rows (neurons)
PR	R-by-2 matrix of input value ranges = [Pmin Pmax]

and returns an S-by-R random matrix with normalized rows.

You can also call this in the form randnr(S,R).

### Examples

A matrix of three normalized four-element rows is generated:

```
M = randnr(3,4)
```

```
M =
```

```
    0.9713    0.0800   -0.1838   -0.1282  
    0.8228    0.0338    0.1797    0.5381  
   -0.3042   -0.5725    0.5436    0.5331
```

### See Also

randnc

**Introduced before R2006a**

## rands

Symmetric random weight/bias initialization function

### Syntax

```
W = rands(S,PR)
M = rands(S,R)
v = rands(S)
```

### Description

rands is a weight/bias initialization function.

`W = rands(S,PR)` takes

S	Number of neurons
PR	R-by-2 matrix of R input ranges

and returns an S-by-R weight matrix of random values between -1 and 1.

`M = rands(S,R)` returns an S-by-R matrix of random values. `v = rands(S)` returns an S-by-1 vector of random values.

### Examples

Here, three sets of random values are generated with rands.

```
rands(4,[0 1; -2 2])
rands(4)
rands(2,3)
```

### Network Use

To prepare the weights and the bias of layer `i` of a custom network to be initialized with rands,

- 1 Set `net.initFcn` to 'initlay'. (`net.initParam` automatically becomes `initlay`'s default parameters.)
- 2 Set `net.layers{i}.initFcn` to 'initwb'.
- 3 Set each `net.inputWeights{i,j}.initFcn` to 'rands'.
- 4 Set each `net.layerWeights{i,j}.initFcn` to 'rands'.
- 5 Set each `net.biases{i}.initFcn` to 'rands'.

To initialize the network, call `init`.

### See Also

`init` | `initlay` | `initwb` | `randnc` | `randnr` | `randsmall`

**Introduced before R2006a**

# randsmall

Small random weight/bias initialization function

## Syntax

```
W = randsmall(S,PR)
M = rands(S,R)
v = rands(S)
```

## Description

`randsmall` is a weight/bias initialization function.

`W = randsmall(S,PR)` takes

S	Number of neurons
PR	R-by-2 matrix of R input ranges

and returns an S-by-R weight matrix of small random values between -0.1 and 0.1.

`M = rands(S,R)` returns an S-by-R matrix of random values. `v = rands(S)` returns an S-by-1 vector of random values.

## Examples

Here three sets of random values are generated with `rands`.

```
randsmall(4,[0 1; -2 2])
randsmall(4)
randsmall(2,3)
```

## Network Use

To prepare the weights and the bias of layer `i` of a custom network to be initialized with `rands`,

- 1 Set `net.initFcn` to `'initlay'`. (`net.initParam` automatically becomes `initlay`'s default parameters.)
- 2 Set `net.layers{i}.initFcn` to `'initwb'`.
- 3 Set each `net.inputWeights{i,j}.initFcn` to `'randsmall'`.
- 4 Set each `net.layerWeights{i,j}.initFcn` to `'randsmall'`.
- 5 Set each `net.biases{i}.initFcn` to `'randsmall'`.

To initialize the network, call `init`.

## See Also

`init` | `initlay` | `initwb` | `randnc` | `randnr` | `rands`

**Introduced in R2010b**



# randtop

Random layer topology function

## Syntax

```
pos = randtop(dimensions)
```

## Description

randtop calculates the neuron positions for layers whose neurons are arranged in an N-dimensional random pattern.

pos = randtop(dimensions) takes one argument:

dimensions	Row vector of dimension sizes
------------	-------------------------------

and returns an N-by-S matrix of N coordinate vectors, where N is the number of dimensions and S is the product of dimensions.

## Examples

### Display Layer with Random Pattern

This shows how to display a two-dimensional layer with neurons arranged in a random pattern.

```
pos = randtop([18 12]);  
plotsom(pos)
```

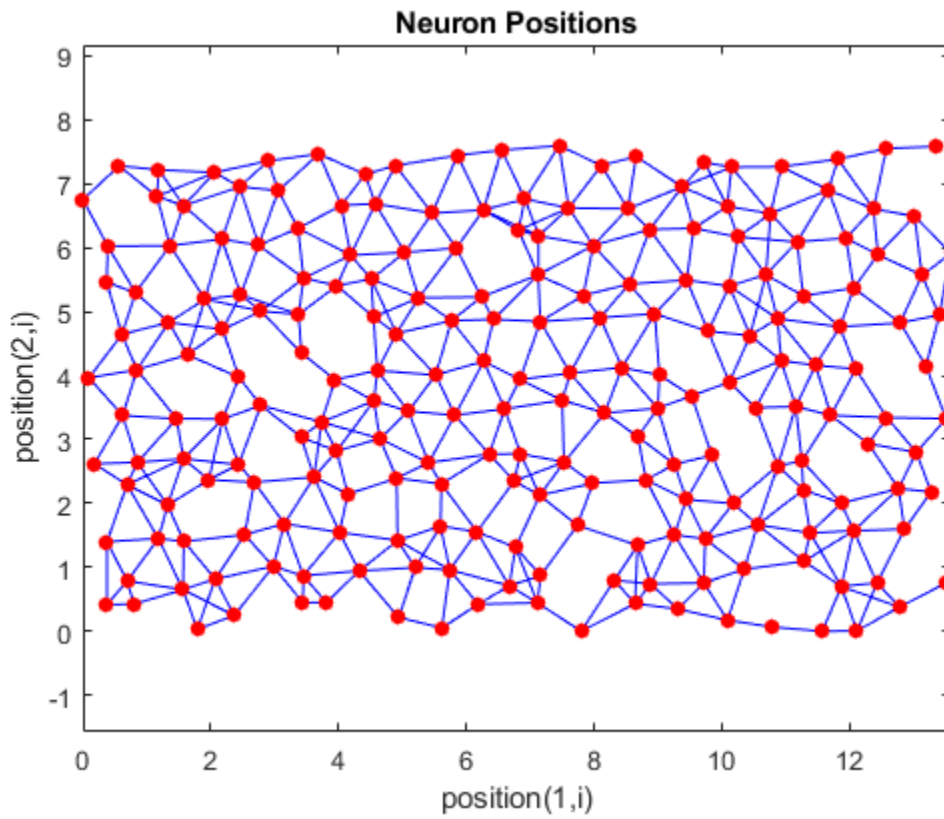

**See Also**

gridtop | hextop | tritop

**Introduced before R2006a**

# regression

Linear regression

## Syntax

```
[r,m,b] = regression(t,y)
[r,m,b] = regression(t,y,'one')
```

## Description

`[r,m,b] = regression(t,y)` takes these arguments,

t	Target matrix or cell array data with a total of N matrix rows
y	Output matrix or cell array data of the same size

and returns these outputs,

r	Regression values for each of the N matrix rows
m	Slope of regression fit for each of the N matrix rows
b	Offset of regression fit for each of the N matrix rows

`[r,m,b] = regression(t,y,'one')` combines all matrix rows before regressing, and returns single scalar regression, slope, and offset values.

## Examples

### Fit Regression Model and Plot Fitted Values versus Targets

Train a feedforward network, then calculate and plot the regression between its targets and outputs.

```
[x,t] = simplefit_dataset;
net = feedforwardnet(20);
net = train(net,x,t);
y = net(x);
[r,m,b] = regression(t,y)
```

```
r = 1.0000
```

```
m = 1.0000
```

```
b = 1.0878e-04
```

```
plotregression(t,y)
```

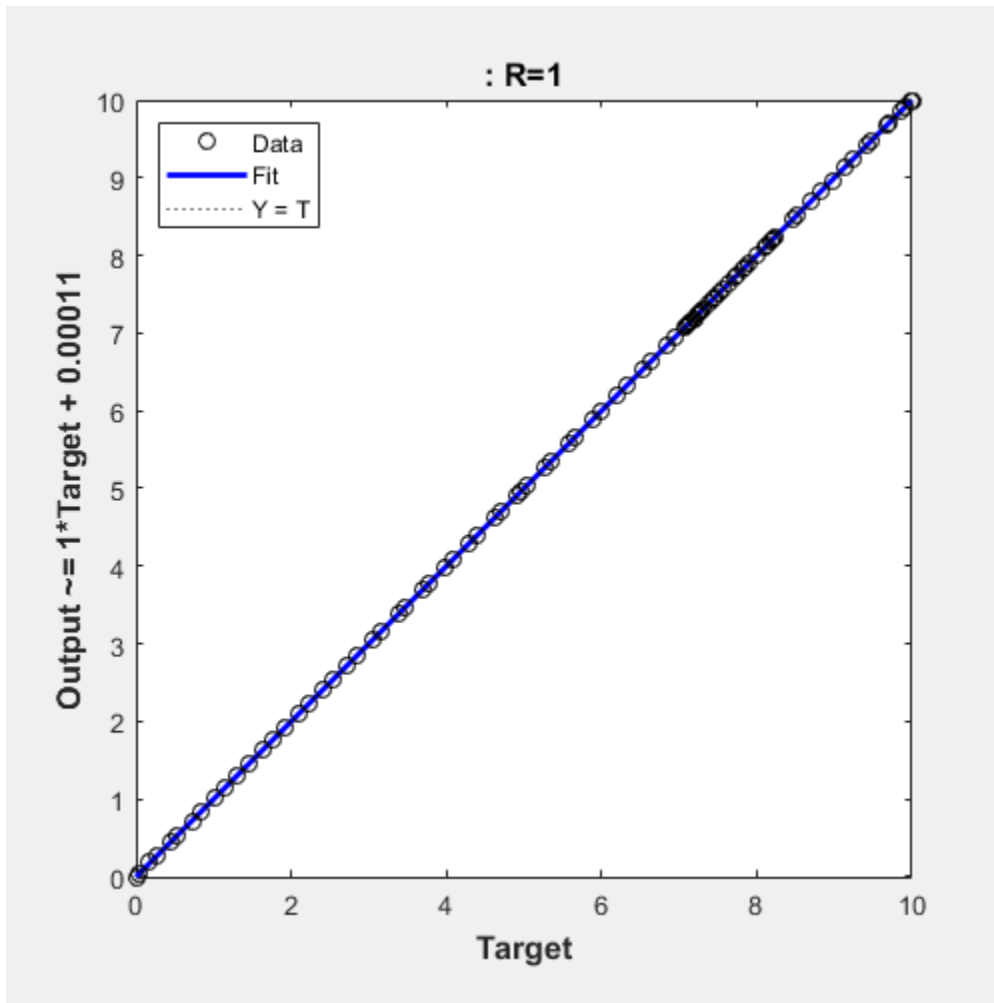

**See Also**

confusion | plotregression

Introduced in R2010b

## removeconstantrows

Process matrices by removing rows with constant values

### Syntax

```
[Y,PS] = removeconstantrows(X,max_range)
[Y,PS] = removeconstantrows(X,FP)
Y = removeconstantrows('apply',X,PS)
X = removeconstantrows('reverse',Y,PS)
```

### Description

removeconstantrows processes matrices by removing rows with constant values.

[Y,PS] = removeconstantrows(X,max\_range) takes X and an optional parameter,

X	N-by-Q matrix
max_range	Maximum range of values for row to be removed (default is 0)

and returns

Y	M-by-Q matrix with N - M rows deleted
PS	Process settings that allow consistent processing of values

[Y,PS] = removeconstantrows(X,FP) takes parameters as a struct: FP.max\_range.

Y = removeconstantrows('apply',X,PS) returns Y, given X and settings PS.

X = removeconstantrows('reverse',Y,PS) returns X, given Y and settings PS.

Any NaN values in the input matrix are treated as missing data, and are not considered as unique values. So, for example, removeconstantrows removes the first row from the matrix [1 1 1 NaN; 1 1 1 2].

### Examples

Format a matrix so that the rows with constant values are removed.

```
x1 = [1 2 4; 1 1 1; 3 2 2; 0 0 0];
[y1,PS] = removeconstantrows(x1);
```

```
y1 =
     1     2     4
     3     2     2
```

```
PS =
    max_range: 0
         keep: [1 3]
        remove: [2 4]
         value: [2x1 double]
```

```
xrows: 4
yrows: 2
constants: [2x1 double]
no_change: 0
```

Next, apply the same processing settings to new values.

```
x2 = [5 2 3; 1 1 1; 6 7 3; 0 0 0];
y2 = removeconstantrows('apply',x2,PS)
```

```
5    2    3
6    7    3
```

Reverse the processing of y1 to get the original x1 matrix.

```
x1_again = removeconstantrows('reverse',y1,PS)
```

```
1    2    4
1    1    1
3    2    2
0    0    0
```

### See Also

[fixunknowns](#) | [mapminmax](#) | [mapstd](#) | [processpca](#)

**Introduced in R2006a**

## removedelay

Remove delay to neural network's response

### Syntax

```
net = removedelay(net,n)
```

### Description

`net = removedelay(net,n)` takes these arguments,

net	Neural network
n	Number of delays

and returns the network with input delay connections decreased, and output feedback delays increased, by the specified number of delays `n`. The result is a network which behaves identically, except that outputs are produced `n` timesteps earlier.

If the number of delays `n` is not specified, a default of one delay is used.

### Examples

#### Remove and Add Delay to Network

This example creates, trains, and simulates a time delay network in its original form, on an input time series `X` and target series `T`. Then the delay is removed and later added back. The first and third outputs will be identical, while the second result will include a new prediction for the following step.

```
[X,T] = simpleseries_dataset;
net1 = timedelaynet(1:2,20);
[Xs,Xi,Ai,Ts] = preparets(net1,X,T);
net1 = train(net1,Xs,Ts,Xi);
y1 = net1(Xs,Xi);
view(net1)
```

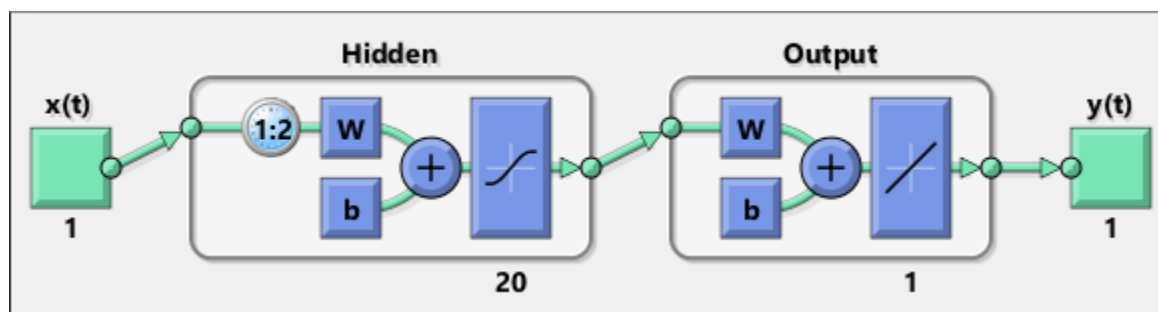

```
net2 = removedelay(net1);
[Xs,Xi,Ai,Ts] = preparets(net2,X,T);
y2 = net2(Xs,Xi);
view(net2)
```

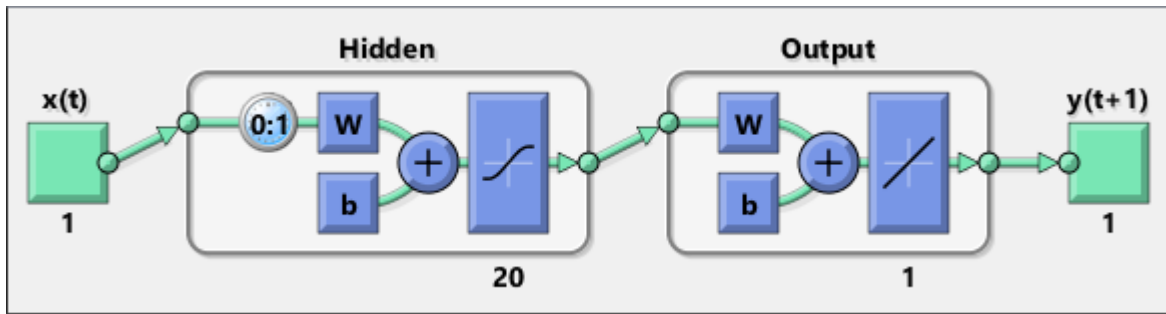

```
net3 = adddelay(net2);
[Xs,Xi,Ai,Ts] = preparets(net3,X,T);
y3 = net3(Xs,Xi);
view(net3)
```

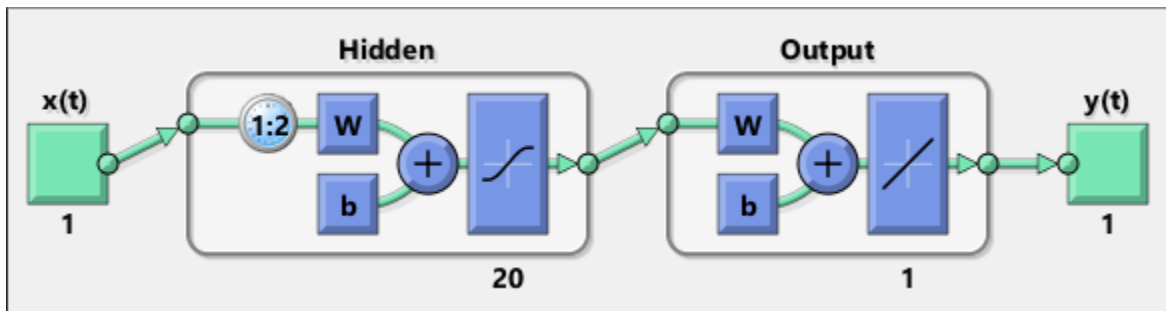

### See Also

[adddelay](#) | [closeloop](#) | [openloop](#)

Introduced in R2010b



## removerows

Process matrices by removing rows with specified indices

### Syntax

```
[Y,PS] = removerows(X,'ind',ind)
[Y,PS] = removerows(X,FP)
Y = removerows('apply',X,PS)
X = removerows('reverse',Y,PS)
dx_dy = removerows('dx',X,Y,PS)
dx_dy = removerows('dx',X,[],PS)
name = removerows('name')
fp = removerows('pdefaults')
names = removerows('pdesc')
removerows('pcheck',FP)
```

### Description

removerows processes matrices by removing rows with the specified indices.

`[Y,PS] = removerows(X,'ind',ind)` takes `X` and an optional parameter,

<code>X</code>	N-by-Q matrix
<code>ind</code>	Vector of row indices to remove (default is <code>[]</code> )

and returns

<code>Y</code>	M-by-Q matrix, where <code>M == N-length(ind)</code>
<code>PS</code>	Process settings that allow consistent processing of values

`[Y,PS] = removerows(X,FP)` takes parameters as a struct: `FP.ind`.

`Y = removerows('apply',X,PS)` returns `Y`, given `X` and settings `PS`.

`X = removerows('reverse',Y,PS)` returns `X`, given `Y` and settings `PS`.

`dx_dy = removerows('dx',X,Y,PS)` returns the M-by-N-by-Q derivative of `Y` with respect to `X`.

`dx_dy = removerows('dx',X,[],PS)` returns the derivative, less efficiently.

`name = removerows('name')` returns the name of this process method.

`fp = removerows('pdefaults')` returns the default process parameter structure.

`names = removerows('pdesc')` returns the process parameter descriptions.

`removerows('pcheck',FP)` throws an error if any parameter is illegal.

### Examples

Here is how to format a matrix so that rows 2 and 4 are removed:

```
x1 = [1 2 4; 1 1 1; 3 2 2; 0 0 0]
[y1,ps] = removerows(x1,'ind',[2 4])
```

Next, apply the same processing settings to new values.

```
x2 = [5 2 3; 1 1 1; 6 7 3; 0 0 0]
y2 = removerows('apply',x2,ps)
```

Reverse the processing of y1 to get x1 again.

```
x1_again = removerows('reverse',y1,ps)
```

### Algorithms

In the reverse calculation, the unknown values of replaced rows are represented with NaN values.

### See Also

[fixunknowns](#) | [mapminmax](#) | [mapstd](#) | [processpca](#)

**Introduced in R2006a**

# revert

Change network weights and biases to previous initialization values

## Syntax

```
net = revert (net)
```

## Description

`net = revert (net)` returns neural network `net` with weight and bias values restored to the values generated the last time the network was initialized.

If the network is altered so that it has different weight and bias connections or different input or layer sizes, then `revert` cannot set the weights and biases to their previous values and they are set to zeros instead.

## Examples

Here a perceptron is created with input size set to 2 and number of neurons to 1.

```
net = perceptron;  
net.inputs{1}.size = 2;  
net.layers{1}.size = 1;
```

The initial network has weights and biases with zero values.

```
net.iw{1,1}, net.b{1}
```

Change these values as follows:

```
net.iw{1,1} = [1 2];  
net.b{1} = 5;  
net.iw{1,1}, net.b{1}
```

You can recover the network's initial values as follows:

```
net = revert(net);  
net.iw{1,1}, net.b{1}
```

## See Also

`adapt` | `init` | `sim` | `train`

**Introduced before R2006a**

## roc

Receiver operating characteristic

### Syntax

```
[tpr, fpr, thresholds] = roc(targets, outputs)
```

### Description

The *receiver operating characteristic* is a metric used to check the quality of classifiers. For each class of a classifier, `roc` applies threshold values across the interval  $[0, 1]$  to outputs. For each threshold, two values are calculated, the True Positive Ratio (TPR) and the False Positive Ratio (FPR). For a particular class  $i$ , TPR is the number of outputs whose actual and predicted class is class  $i$ , divided by the number of outputs whose predicted class is class  $i$ . FPR is the number of outputs whose actual class is not class  $i$ , but predicted class is class  $i$ , divided by the number of outputs whose predicted class is not class  $i$ .

You can visualize the results of this function with `plotroc`.

`[tpr, fpr, thresholds] = roc(targets, outputs)` takes these arguments:

<code>targets</code>	S-by-Q matrix, where each column vector contains a single 1 value, with all other elements 0. The index of the 1 indicates which of S categories that vector represents.
<code>outputs</code>	S-by-Q matrix, where each column contains values in the range $[0, 1]$ . The index of the largest element in the column indicates which of S categories that vector presents. Alternately, 1-by-Q vector, where values greater or equal to 0.5 indicate class membership, and values below 0.5, nonmembership.

and returns these values:

<code>tpr</code>	1-by-S cell array of 1-by-N true-positive/positive ratios.
<code>fpr</code>	1-by-S cell array of 1-by-N false-positive/negative ratios.
<code>thresholds</code>	1-by-S cell array of 1-by-N thresholds over interval $[0, 1]$ .

`roc(targets, outputs)` takes these arguments:

<code>targets</code>	1-by-Q matrix of Boolean values indicating class membership.
<code>outputs</code>	S-by-Q matrix, of values in $[0, 1]$ interval, where values greater than or equal to 0.5 indicate class membership.

and returns these values:

<code>tpr</code>	1-by-N vector of true-positive/positive ratios.
<code>fpr</code>	1-by-N vector of false-positive/negative ratios.

thresholds	1-by-N vector of thresholds over interval $[0, 1]$ .
------------	--

## Examples

```
load iris_dataset
net = patternnet(20);
net = train(net,irisInputs,irisTargets);
irisOutputs = sim(net,irisInputs);
[tpr,fpr,thresholds] = roc(irisTargets,irisOutputs)
```

## See Also

[confusion](#) | [plotroc](#)

**Introduced in R2008a**

## sae

Sum absolute error performance function

### Syntax

```
perf = sae(net,t,y,ew)
[...] = sae(...,'regularization',regularization)
[...] = sae(...,'normalization',normalization)
[...] = sae(...,FP)
```

### Description

`sae` is a network performance function. It measures performance according to the sum of squared errors.

`perf = sae(net,t,y,ew)` takes these input arguments and optional function parameters,

<code>net</code>	Neural network
<code>t</code>	Matrix or cell array of target vectors
<code>y</code>	Matrix or cell array of output vectors
<code>ew</code>	Error weights (default = {1})

and returns the sum squared error.

This function has two optional function parameters that can be defined with parameter name/pair arguments, or as a structure `FP` argument with fields having the parameter name and assigned the parameter values:

```
[...] = sae(...,'regularization',regularization)
```

```
[...] = sae(...,'normalization',normalization)
```

```
[...] = sae(...,FP)
```

- `regularization` — can be set to any value between the default of 0 and 1. The greater the regularization value, the more squared weights and biases are taken into account in the performance calculation.
- `normalization`
  - `'none'` — performs no normalization, the default.
  - `'standard'` — normalizes outputs and targets to  $[-1, +1]$ , and therefore normalizes errors to  $[-2, +2]$ .
  - `'percent'` — normalizes outputs and targets to  $[-0.5, +0.5]$ , and therefore normalizes errors to  $[-1, +1]$ .

### Examples

Here a network is trained to fit a simple data set and its performance calculated

```
[x,t] = simplefit_dataset;  
net = fitnet(10,'trainscg');  
net.performFcn = 'sae';  
net = train(net,x,t)  
y = net(x)  
e = t-y  
perf = sae(net,t,y)
```

## Network Use

To prepare a custom network to be trained with `sae`, set `net.performFcn` to `'sae'`. This automatically sets `net.performParam` to the default function parameters.

Then calling `train`, `adapt` or `perform` will result in `sae` being used to calculate performance.

### Introduced in R2010b

## satlin

Saturating linear transfer function

### Graph and Symbol

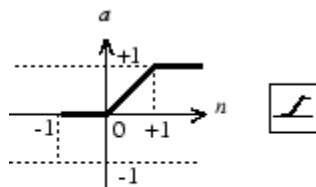

$$a = \text{satlin}(n)$$

Satlin Transfer Function

### Syntax

$A = \text{satlin}(N, FP)$

### Description

`satlin` is a neural transfer function. Transfer functions calculate a layer's output from its net input.

$A = \text{satlin}(N, FP)$  takes one input,

N	S-by-Q matrix of net input (column) vectors
FP	Struct of function parameters (ignored)

and returns  $A$ , the S-by-Q matrix of  $N$ 's elements clipped to  $[0, 1]$ .

`info = satlin('code')` returns useful information for each supported `code` character vector:

`satlin('name')` returns the name of this function.

`satlin('output', FP)` returns the `[min max]` output range.

`satlin('active', FP)` returns the `[min max]` active input range.

`satlin('fullderiv')` returns 1 or 0, depending on whether `dA_dN` is S-by-S-by-Q or S-by-Q.

`satlin('fpnames')` returns the names of the function parameters.

`satlin('fpdefaults')` returns the default function parameters.

### Examples

Here is the code to create a plot of the `satlin` transfer function.



```
n = -5:0.1:5;  
a = satlin(n);  
plot(n,a)
```

Assign this transfer function to layer *i* of a network.

```
net.layers{i}.transferFcn = 'satlin';
```

## Algorithms

```
a = satlin(n) = 0, if n <= 0  
n, if 0 <= n <= 1  
1, if 1 <= n
```

## See Also

[poslin](#) | [purelin](#) | [satlins](#) | [sim](#)

**Introduced before R2006a**

## satlins

Symmetric saturating linear transfer function

### Graph and Symbol

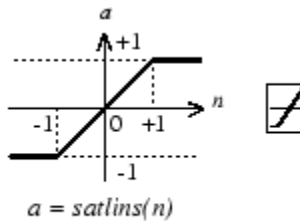

Satlins Transfer Function

### Syntax

$A = \text{satlins}(N, FP)$

### Description

`satlins` is a neural transfer function. Transfer functions calculate a layer's output from its net input.

$A = \text{satlins}(N, FP)$  takes  $N$  and an optional argument,

$N$	S-by-Q matrix of net input (column) vectors
$FP$	Struct of function parameters (optional, ignored)

and returns  $A$ , the S-by-Q matrix of  $N$ 's elements clipped to  $[-1, 1]$ .

`info = satlins('code')` returns useful information for each supported *code* character vector:

`satlins('name')` returns the name of this function.

`satlins('output', FP)` returns the `[min max]` output range.

`satlins('active', FP)` returns the `[min max]` active input range.

`satlins('fullderiv')` returns 1 or 0, depending on whether  $dA_{dN}$  is S-by-S-by-Q or S-by-Q.

`satlins('fpnames')` returns the names of the function parameters.

`satlins('fpdefaults')` returns the default function parameters.

### Examples

Here is the code to create a plot of the `satlins` transfer function.

```
n = -5:0.1:5;  
a = satlins(n);  
plot(n,a)
```

## Algorithms

```
satlins(n) = -1, if n <= -1  
n, if -1 <= n <= 1  
1, if 1 <= n
```

## See Also

[poslin](#) | [purelin](#) | [satlin](#) | [sim](#)

**Introduced before R2006a**

## scalprod

Scalar product weight function

### Syntax

```
Z = scalprod(W,P)
dim = scalprod('size',S,R,FP)
dw = scalprod('dw',W,P,Z,FP)
```

### Description

`scalprod` is the scalar product weight function. Weight functions apply weights to an input to get weighted inputs.

`Z = scalprod(W,P)` takes these inputs,

W	1-by-1 weight matrix
P	R-by-Q matrix of Q input (column) vectors

and returns the R-by-Q scalar product of W and P defined by  $Z = w*P$ .

`dim = scalprod('size',S,R,FP)` takes the layer dimension S, input dimension R, and function parameters, and returns the weight size [1-by-1].

`dw = scalprod('dw',W,P,Z,FP)` returns the derivative of Z with respect to W.

### Examples

Here you define a random weight matrix W and input vector P and calculate the corresponding weighted input Z.

```
W = rand(1,1);
P = rand(3,1);
Z = scalprod(W,P)
```

### Network Use

To change a network so an input weight uses `scalprod`, set `net.inputWeights{i,j}.weightFcn` to `'scalprod'`.

For a layer weight, set `net.layerWeights{i,j}.weightFcn` to `'scalprod'`.

In either case, call `sim` to simulate the network with `scalprod`.

### See Also

`dist` | `dotprod` | `negdist` | `normprod` | `sim`

**Introduced in R2006a**

## selforgmap

Self-organizing map

### Syntax

```
selforgmap(dimensions,coverSteps,initNeighbor,topologyFcn,distanceFcn)
```

### Description

Self-organizing maps learn to cluster data based on similarity, topology, with a preference (but no guarantee) of assigning the same number of instances to each class.

Self-organizing maps are used both to cluster data and to reduce the dimensionality of data. They are inspired by the sensory and motor mappings in the mammal brain, which also appear to automatically organizing information topologically.

`selforgmap(dimensions,coverSteps,initNeighbor,topologyFcn,distanceFcn)` takes these arguments,

<code>dimensions</code>	Row vector of dimension sizes (default = [8 8])
<code>coverSteps</code>	Number of training steps for initial covering of the input space (default = 100)
<code>initNeighbor</code>	Initial neighborhood size (default = 3)
<code>topologyFcn</code>	Layer topology function (default = 'hextop')
<code>distanceFcn</code>	Neuron distance function (default = 'linkdist')

and returns a self-organizing map.

### Examples

#### Use Self-Organizing Map to Cluster Data

Here a self-organizing map is used to cluster a simple set of data.

```
x = simplecluster_dataset;
net = selforgmap([8 8]);
net = train(net,x);
view(net)
y = net(x);
classes = vec2ind(y);
```

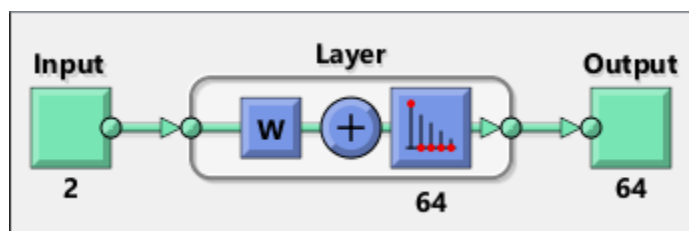

## **See Also**

competlayer | lvqnet | nctool

**Introduced in R2010b**

## separatewb

Separate biases and weight values from weight/bias vector

### Syntax

```
[b,IW,LW] = separatewb(net,wb)
```

### Description

[b,IW,LW] = separatewb(net,wb) takes two arguments,

net	Neural network
wb	Weight/bias vector

and returns

b	Cell array of bias vectors
IW	Cell array of input weight matrices
LW	Cell array of layer weight matrices

### Examples

Here a feedforward network is trained to fit some data, then its bias and weight values formed into a vector. The single vector is then redivided into the original biases and weights.

```
[x,t] = simplefit_dataset;  
net = feedforwardnet(20);  
net = train(net,x,t);  
wb = formwb(net,net.b,net.iw,net.lw)  
[b,iw,lw] = separatewb(net,wb)
```

### See Also

formwb | getwb | setwb

**Introduced in R2010b**



# seq2con

Convert sequential vectors to concurrent vectors

## Syntax

`b = seq2con(s)`

## Description

Deep Learning Toolbox software represents batches of vectors with a matrix, and sequences of vectors with multiple columns of a cell array.

`seq2con` and `con2seq` allow concurrent vectors to be converted to sequential vectors, and back again.

`b = seq2con(s)` takes one input,

<code>s</code>	N-by-TS cell array of matrices with M columns
----------------	---

and returns

<code>b</code>	N-by-1 cell array of matrices with M*TS columns
----------------	---

## Examples

Here three sequential values are converted to concurrent values.

```
p1 = {1 4 2}
p2 = seq2con(p1)
```

Here two sequences of vectors over three time steps are converted to concurrent vectors.

```
p1 = {[1; 1] [5; 4] [1; 2]; [3; 9] [4; 1] [9; 8]}
p2 = seq2con(p1)
```

## See Also

`con2seq` | `concur`

Introduced before R2006a

## setelements

Set neural network data elements

### Syntax

```
setelements(x,i,v)
```

### Description

`setelements(x,i,v)` takes these arguments,

<code>x</code>	Neural network matrix or cell array data
<code>i</code>	Indices
<code>v</code>	Neural network data to store into <code>x</code>

and returns the original data `x` with the data `v` stored in the elements indicated by the indices `i`.

### Examples

This code sets elements 1 and 3 of matrix data:

```
x = [1 2; 3 4; 7 4]
v = [10 11; 12 13];
y = setelements(x,[1 3],v)
```

This code sets elements 1 and 3 of cell array data:

```
x = {[1:3; 4:6] [7:9; 10:12]; [13:15] [16:18]}
v = {[20 21 22; 23 24 25] [26 27 28; 29 30 31]}
y = setelements(x,[1 3],v)
```

### See Also

`catelements` | `getelements` | `nndata` | `numelements` | `setsamples` | `setsignals` | `settimesteps`

**Introduced in R2010b**

## setsamples

Set neural network data samples

### Syntax

```
setsamples(x,i,v)
```

### Description

setsamples(x,i,v) takes these arguments,

x	Neural network matrix or cell array data
i	Indices
v	Neural network data to store into x

and returns the original data x with the data v stored in the samples indicated by the indices i.

### Examples

This code sets samples 1 and 3 of matrix data:

```
x = [1 2 3; 4 7 4]
v = [10 11; 12 13];
y = setsamples(x,[1 3],v)
```

This code sets samples 1 and 3 of cell array data:

```
x = {[1:3; 4:6] [7:9; 10:12]; [13:15] [16:18]}
v = {[20 21; 22 23] [24 25; 26 27]; [28 29] [30 31]}
y = setsamples(x,[1 3],v)
```

### See Also

[catsamples](#) | [getsamples](#) | [nndata](#) | [numsamples](#) | [setelements](#) | [setsignals](#) | [settimesteps](#)

**Introduced in R2010b**

## setsignals

Set neural network data signals

### Syntax

```
setsignals(x,i,v)
```

### Description

`setsignals(x,i,v)` takes these arguments,

<code>x</code>	Neural network matrix or cell array data
<code>i</code>	Indices
<code>v</code>	Neural network data to store into <code>x</code>

and returns the original data `x` with the data `v` stored in the signals indicated by the indices `i`.

### Examples

This code sets signal 2 of cell array data:

```
x = {[1:3; 4:6] [7:9; 10:12]; [13:15] [16:18]}
v = {[20:22] [23:25]}
y = setsignals(x,2,v)
```

### See Also

`catsignals` | `getsignals` | `nndata` | `numsignals` | `setelements` | `setsamples` | `settimesteps`

**Introduced in R2010b**

## setsiminit

Set neural network Simulink block initial conditions

### Syntax

```
setsiminit(sysName,netName,net,xi,ai,Q)
```

### Description

`setsiminit(sysName,netName,net,xi,ai,Q)` takes these arguments,

<code>sysName</code>	The name of the Simulink system containing the neural network block
<code>netName</code>	The name of the Simulink neural network block
<code>net</code>	The original neural network
<code>xi</code>	Initial input delay states
<code>ai</code>	Initial layer delay states
<code>Q</code>	Sample number (default is 1)

and sets the Simulink neural network blocks initial conditions as specified.

### Examples

Here a NARX network is designed. The NARX network has a standard input and an open loop feedback output to an associated feedback input.

```
[x,t] = simplenarx_dataset;
net = narxnet(1:2,1:2,20);
view(net)
[xs,xi,ai,ts] = preparets(net,x,{},t);
net = train(net,xs,ts,xi,ai);
y = net(xs,xi,ai);
```

Now the network is converted to closed loop, and the data is reformatted to simulate the network's closed loop response.

```
net = closeloop(net);
view(net)
[xs,xi,ai,ts] = preparets(net,x,{},t);
y = net(xs,xi,ai);
```

Here the network is converted to a Simulink system with workspace input and output ports. Its delay states are initialized, inputs `X1` defined in the workspace, and it is ready to be simulated in Simulink.

```
[sysName,netName] = gensim(net,'InputMode','Workspace',...
    'OutputMode','WorkSpace','SolverMode','Discrete');
setsiminit(sysName,netName,net,xi,ai,1);
x1 = nndata2sim(x,1,1);
```

Finally the initial input and layer delays are obtained from the Simulink model. (They will be identical to the values set with `setsiminit`.)

```
[xi,ai] = getsiminit(sysName,netName,net);
```

**See Also**

[gensim](#) | [getsiminit](#) | [nndata2sim](#) | [sim2nndata](#)

**Introduced in R2010b**

# settimesteps

Set neural network data timesteps

## Syntax

```
settimesteps(x,i,v)
```

## Description

`settimesteps(x,i,v)` takes these arguments,

<code>x</code>	Neural network matrix or cell array data
<code>i</code>	Indices
<code>v</code>	Neural network data to store into <code>x</code>

and returns the original data `x` with the data `v` stored in the timesteps indicated by the indices `i`.

## Examples

This code sets timestep 2 of cell array data:

```
x = {[1:3; 4:6] [7:9; 10:12]; [13:15] [16:18]}  
v = {[20:22; 23:25]; [25:27]}  
y = settimesteps(x,2,v)
```

## See Also

`cattimesteps` | `gettimesteps` | `nndata` | `numtimesteps` | `setelements` | `setsamples` | `setsignals`

**Introduced in R2010b**

## setwb

Set all network weight and bias values with single vector

### Syntax

```
net = setwb(net,wb)
```

### Description

This function sets a network's weight and biases to a vector of values.

`net = setwb(net,wb)` takes the following inputs:

net	Neural network
wb	Vector of weight and bias values

### Examples

#### Set Network's Weights and Biases

This example shows how to set and view a network's weight and bias values.

Create and configure a network.

```
[x,t] = simplefit_dataset;
net = feedforwardnet(3);
net = configure(net,x,t);
view(net)
```

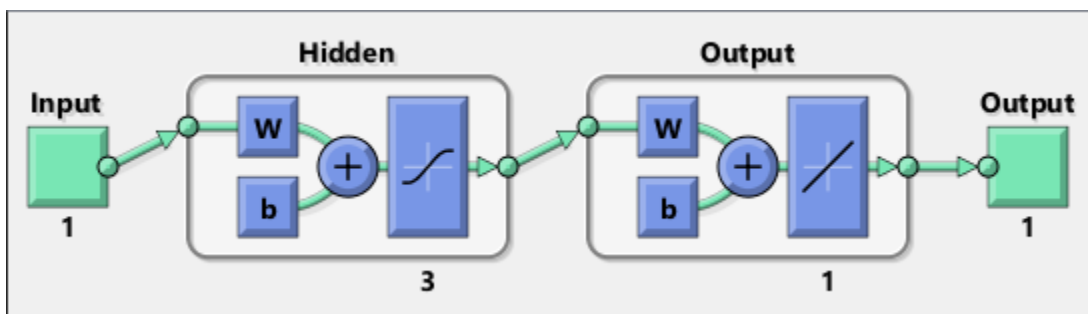

This network has three weights and three biases in the first layer, and three weights and one bias in the second layer. So, the total number of weight and bias values in the network is 10. Set the weights and biases to random values.

```
net = setwb(net,rand(10,1));
```

View the weight and bias values

```
net.IW{1,1}
net.b{1}
```



```
ans =
```

```
 0.1576  
 0.9706  
 0.9572
```

```
ans =
```

```
 0.5469  
 0.9575  
 0.9649
```

## **See Also**

[formwb](#) | [getwb](#) | [separatwb](#)

**Introduced in R2010b**

## sim

Simulate neural network

### Syntax

```
[Y,Xf,Af] = sim(net,X,Xi,Ai,T)
[Y,Xf,Af] = sim(net,{Q TS},Xi,Ai)
[Y,...] = sim(net,...,'useParallel',...)
[Y,...] = sim(net,...,'useGPU',...)
[Y,...] = sim(net,...,'showResources',...)
[Ycomposite,...] = sim(net,Xcomposite,...)
[Ygpu,...] = sim(net,Xgpu,...)
```

### To Get Help

Type `help network/sim`.

### Description

`sim` simulates neural networks.

`[Y,Xf,Af] = sim(net,X,Xi,Ai,T)` takes

<code>net</code>	Network
<code>X</code>	Network inputs
<code>Xi</code>	Initial input delay conditions (default = zeros)
<code>Ai</code>	Initial layer delay conditions (default = zeros)
<code>T</code>	Network targets (default = zeros)

and returns

<code>Y</code>	Network outputs
<code>Xf</code>	Final input delay conditions
<code>Af</code>	Final layer delay conditions

`sim` is usually called implicitly by calling the neural network as a function. For instance, these two expressions return the same result:

```
y = sim(net,x,xi,ai)
y = net(x,xi,ai)
```

Note that arguments `Xi`, `Ai`, `Xf`, and `Af` are optional and need only be used for networks that have input or layer delays.

The signal arguments can have two formats: cell array or matrix.

The cell array format is easiest to describe. It is most convenient for networks with multiple inputs and outputs, and allows sequences of inputs to be presented:

X	Ni-by-TS cell array	Each element $X\{i, ts\}$ is an $R_i$ -by- $Q$ matrix.
$X_i$	Ni-by-ID cell array	Each element $X_i\{i, k\}$ is an $R_i$ -by- $Q$ matrix.
$A_i$	Nl-by-LD cell array	Each element $A_i\{i, k\}$ is an $S_i$ -by- $Q$ matrix.
T	No-by-TS cell array	Each element $X\{i, ts\}$ is a $U_i$ -by- $Q$ matrix.
Y	No-by-TS cell array	Each element $Y\{i, ts\}$ is a $U_i$ -by- $Q$ matrix.
$X_f$	Ni-by-ID cell array	Each element $X_f\{i, k\}$ is an $R_i$ -by- $Q$ matrix.
$A_f$	Nl-by-LD cell array	Each element $A_f\{i, k\}$ is an $S_i$ -by- $Q$ matrix.

where

Ni	=	<code>net.numInputs</code>
Nl	=	<code>net.numLayers</code>
No	=	<code>net.numOutputs</code>
ID	=	<code>net.numInputDelays</code>
LD	=	<code>net.numLayerDelays</code>
TS	=	Number of time steps
Q	=	Batch size
$R_i$	=	<code>net.inputs{i}.size</code>
$S_i$	=	<code>net.layers{i}.size</code>
$U_i$	=	<code>net.outputs{i}.size</code>

The columns of  $X_i$ ,  $A_i$ ,  $X_f$ , and  $A_f$  are ordered from oldest delay condition to most recent:

$X_i\{i, k\}$	=	Input $i$ at time $ts = k - ID$
$X_f\{i, k\}$	=	Input $i$ at time $ts = TS + k - ID$
$A_i\{i, k\}$	=	Layer output $i$ at time $ts = k - LD$
$A_f\{i, k\}$	=	Layer output $i$ at time $ts = TS + k - LD$

The matrix format can be used if only one time step is to be simulated ( $TS = 1$ ). It is convenient for networks with only one input and output, but can also be used with networks that have more.

Each matrix argument is found by storing the elements of the corresponding cell array argument in a single matrix:

X	(sum of $R_i$ )-by- $Q$ matrix
$X_i$	(sum of $R_i$ )-by-( $ID*Q$ ) matrix
$A_i$	(sum of $S_i$ )-by-( $LD*Q$ ) matrix
T	(sum of $U_i$ )-by- $Q$ matrix
Y	(sum of $U_i$ )-by- $Q$ matrix
$X_f$	(sum of $R_i$ )-by-( $ID*Q$ ) matrix
$A_f$	(sum of $S_i$ )-by-( $LD*Q$ ) matrix

$[Y, X_f, A_f] = \text{sim}(\text{net}, \{Q \text{ TS}\}, X_i, A_i)$  is used for networks that do not have an input when cell array notation is used.

`[Y,...] = sim(net,...,'useParallel',...)`, `[Y,...] = sim(net,...,'useGPU',...)`, or `[Y,...] = sim(net,...,'showResources',...)` (or the network called as a function) accepts optional name/value pair arguments to control how calculations are performed. Two of these options allow training to happen faster or on larger datasets using parallel workers or GPU devices if Parallel Computing Toolbox is available. These are the optional name/value pairs:

'useParallel','no'	Calculations occur on normal MATLAB thread. This is the default 'useParallel' setting.
'useParallel','yes'	Calculations occur on parallel workers if a parallel pool is open. Otherwise calculations occur on the normal MATLAB thread.
'useGPU','no'	Calculations occur on the CPU. This is the default 'useGPU' setting.
'useGPU','yes'	Calculations occur on the current gpuDevice if it is a supported GPU (See Parallel Computing Toolbox for GPU requirements.) If the current gpuDevice is not supported, calculations remain on the CPU. If 'useParallel' is also 'yes' and a parallel pool is open, then each worker with a unique GPU uses that GPU, other workers run calculations on their respective CPU cores.
'useGPU','only'	If no parallel pool is open, then this setting is the same as 'yes'. If a parallel pool is open, then only workers with unique GPUs are used. However, if a parallel pool is open, but no supported GPUs are available, then calculations revert to performing on all worker CPUs.
'showResources','no'	Do not display computing resources used at the command line. This is the default setting.
'showResources','yes'	Show at the command line a summary of the computing resources actually used. The actual resources may differ from the requested resources, if parallel or GPU computing is requested but a parallel pool is not open or a supported GPU is not available. When parallel workers are used, each worker's computation mode is described, including workers in the pool that are not used.

`[Ycomposite,...] = sim(net,Xcomposite,...)` takes Composite data and returns Composite results. If Composite data is used, then 'useParallel' is automatically set to 'yes'.

`[Ygpu,...] = sim(net,Xgpu,...)` takes gpuArray data and returns gpuArray results. If gpuArray data is used, then 'useGPU' is automatically set to 'yes'.

## Examples

In the following examples, the `sim` function is called implicitly by calling the neural network object (`net`) as a function.

### Simulate Feedforward Networks

This example loads a dataset that maps anatomical measurements `x` to body fat percentages `t`. A feedforward network with 10 neurons is created and trained on that data, then simulated.

```
[x,t] = bodyfat_dataset;
net = feedforwardnet(10);
net = train(net,x,t);
y = net(x);
```

## Simulate NARX Time Series Networks

This example trains an open-loop nonlinear-autoregressive network with external input, to model a levitated magnet system defined by a control current  $x$  and the magnet's vertical position response  $t$ , then simulates the network. The function `preparets` prepares the data before training and simulation. It creates the open-loop network's combined inputs  $x_0$ , which contains both the external input  $x$  and previous values of position  $t$ . It also prepares the delay states  $x_i$ .

```
[x,t] = maglev_dataset;
net = narxnet(10);
[xo,xi,~,to] = preparets(net,x,{},t);
net = train(net,xo,to,xi);
y = net(xo,xi)
```

This same system can also be simulated in closed-loop form.

```
netc = closeloop(net);
view(netc)
[xc,xi,ai,tc] = preparets(netc,x,{},t);
yc = netc(xc,xi,ai);
```

## Simulate in Parallel on a Parallel Pool

With Parallel Computing Toolbox you can simulate and train networks faster and on larger datasets than can fit on one PC. Here training and simulation happens across parallel MATLAB workers.

```
parpool
[X,T] = vinyl_dataset;
net = feedforwardnet(10);
net = train(net,X,T,'useParallel','yes','showResources','yes');
Y = net(X,'useParallel','yes');
```

## Simulate on GPUs

Use Composite values to distribute the data manually, and get back the results as a Composite value. If the data is loaded as it is distributed, then while each piece of the dataset must fit in RAM, the entire dataset is limited only by the total RAM of all the workers.

```
Xc = Composite;
for i=1:numel(Xc)
    Xc{i} = X+rand(size(X))*0.1; % Use real data instead of random
end
Yc = net(Xc,'showResources','yes');
```

Networks can be simulated using the current GPU device, if it is supported by Parallel Computing Toolbox.

```
gpuDevice % Check if there is a supported GPU
Y = net(X,'useGPU','yes','showResources','yes');
```

To put the data on a GPU manually, and get the results on the GPU:

```
Xgpu = gpuArray(X);
Ygpu = net(Xgpu,'showResources','yes');
Y = gather(Ygpu);
```

To run in parallel, with workers associated with unique GPUs taking advantage of that hardware, while the rest of the workers use CPUs:

```
Y = net(X, 'useParallel', 'yes', 'useGPU', 'yes', 'showResources', 'yes');
```

Using only workers with unique GPUs might result in higher speeds, as CPU workers might not keep up.

```
Y = net(X, 'useParallel', 'yes', 'useGPU', 'only', 'showResources', 'yes');
```

## Algorithms

`sim` uses these properties to simulate a network `net`.

```
net.numInputs, net.numLayers  
net.outputConnect, net.biasConnect  
net.inputConnect, net.layerConnect
```

These properties determine the network's weight and bias values and the number of delays associated with each weight:

```
net.IW{i,j}  
net.LW{i,j}  
net.b{i}  
net.inputWeights{i,j}.delays  
net.layerWeights{i,j}.delays
```

These function properties indicate how `sim` applies weight and bias values to inputs to get each layer's output:

```
net.inputWeights{i,j}.weightFcn  
net.layerWeights{i,j}.weightFcn  
net.layers{i}.netInputFcn  
net.layers{i}.transferFcn
```

## See Also

`adapt` | `init` | `revert` | `train`

**Introduced before R2006a**

# sim2nndata

Convert Simulink time series to neural network data

## Syntax

```
sim2nndata(x)
```

## Description

`sim2nndata(x)` takes either a column vector of values or a Simulink time series structure and converts it to a neural network data time series.

## Examples

Here a random Simulink 20-step time series is created and converted.

```
simts = rands(20,1);  
nnts = sim2nndata(simts)
```

Here a similar time series is defined with a Simulink structure and converted.

```
simts.time = 0:19  
simts.signals.values = rands(20,1);  
simts.dimensions = 1;  
nnts = sim2nndata(simts)
```

## See Also

[nndata](#) | [nndata2sim](#)

**Introduced in R2010b**

## softmax

Soft max transfer function

### Graph and Symbol

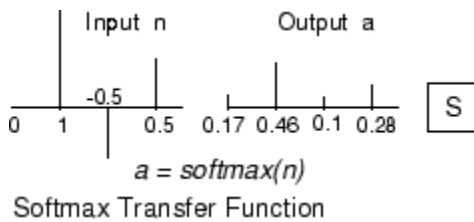

### Syntax

$A = \text{softmax}(N, FP)$

### Description

`softmax` is a neural transfer function. Transfer functions calculate a layer's output from its net input.

$A = \text{softmax}(N, FP)$  takes  $N$  and optional function parameters,

$N$	S-by-Q matrix of net input (column) vectors
$FP$	Struct of function parameters (ignored)

and returns  $A$ , the S-by-Q matrix of the softmax competitive function applied to each column of  $N$ .

`info = softmax('code')` returns information about this function. The following codes are defined:

`softmax('name')` returns the name of this function.

`softmax('output', FP)` returns the [min max] output range.

`softmax('active', FP)` returns the [min max] active input range.

`softmax('fullderiv')` returns 1 or 0, depending on whether  $dA_{dN}$  is S-by-S-by-Q or S-by-Q.

`softmax('fpnames')` returns the names of the function parameters.

`softmax('fpdefaults')` returns the default function parameters.

### Examples

Here you define a net input vector  $N$ , calculate the output, and plot both with bar graphs.

```
n = [0; 1; -0.5; 0.5];
a = softmax(n);
```



```
subplot(2,1,1), bar(n), ylabel('n')  
subplot(2,1,2), bar(a), ylabel('a')
```

Assign this transfer function to layer *i* of a network.

```
net.layers{i}.transferFcn = 'softmax';
```

## Algorithms

$$a = \text{softmax}(n) = \frac{\exp(n)}{\sum(\exp(n))}$$

## See Also

[compet](#) | [sim](#)

**Introduced before R2006a**

## srchbac

1-D minimization using backtracking

### Syntax

```
[a,gX,perf,retcode,delta,tol] =
srchbac(net,X,Pd,Tl,Ai,Q,TS,dX,gX,perf,dperf,delta,TOL,ch_perf)
```

### Description

srchbac is a linear search routine. It searches in a given direction to locate the minimum of the performance function in that direction. It uses a technique called backtracking.

[a,gX,perf,retcode,delta,tol] = srchbac(net,X,Pd,Tl,Ai,Q,TS,dX,gX,perf,dperf,delta,TOL,ch\_perf) takes these inputs,

net	Neural network
X	Vector containing current values of weights and biases
Pd	Delayed input vectors
Tl	Layer target vectors
Ai	Initial input delay conditions
Q	Batch size
TS	Time steps
dX	Search direction vector
gX	Gradient vector
perf	Performance value at current X
dperf	Slope of performance value at current X in direction of dX
delta	Initial step size
tol	Tolerance on search
ch_perf	Change in performance on previous step

and returns

a	Step size that minimizes performance
gX	Gradient at new minimum point
perf	Performance value at new minimum point
retcode	Return code that has three elements. The first two elements correspond to the number of function evaluations in the two stages of the search. The third element is a return code. These have different meanings for different search algorithms. Some might not be used in this function.

	0 Normal
	1 Minimum step taken
	2 Maximum step taken
	3 Beta condition not met
delta	New initial step size, based on the current step size
tol	New tolerance on search

Parameters used for the backstepping algorithm are

alpha	Scale factor that determines sufficient reduction in perf
beta	Scale factor that determines sufficiently large step size
low_lim	Lower limit on change in step size
up_lim	Upper limit on change in step size
maxstep	Maximum step length
minstep	Minimum step length
scale_tol	Parameter that relates the tolerance tol to the initial step size delta, usually set to 20

The defaults for these parameters are set in the training function that calls them. See `traincgf`, `traincgb`, `traincgp`, `trainbfg`, and `trainoss`.

Dimensions for these variables are

Pd	No-by-Ni-by-TS cell array	Each element $P\{i, j, ts\}$ is a $D_{ij}$ -by- $Q$ matrix.
Tl	Nl-by-TS cell array	Each element $P\{i, ts\}$ is a $V_i$ -by- $Q$ matrix.
V	Nl-by-LD cell array	Each element $A_i\{i, k\}$ is an $S_i$ -by- $Q$ matrix.

where

Ni	=	<code>net.numInputs</code>
Nl	=	<code>net.numLayers</code>
LD	=	<code>net.numLayerDelays</code>
Ri	=	<code>net.inputs{i}.size</code>
Si	=	<code>net.layers{i}.size</code>
Vi	=	<code>net.targets{i}.size</code>
Dij	=	<code>Ri * length(net.inputWeights{i,j}.delays)</code>

## More About

### Backtracking Search

The backtracking search routine `srchbac` is best suited to use with the quasi-Newton optimization algorithms. It begins with a step multiplier of 1 and then backtracks until an acceptable reduction in the performance is obtained. On the first step it uses the value of performance at the current point and a step multiplier of 1. It also uses the value of the derivative of performance at the current point

to obtain a quadratic approximation to the performance function along the search direction. The minimum of the quadratic approximation becomes a tentative optimum point (under certain conditions) and the performance at this point is tested. If the performance is not sufficiently reduced, a cubic interpolation is obtained and the minimum of the cubic interpolation becomes the new tentative optimum point. This process is continued until a sufficient reduction in the performance is obtained.

The backtracking algorithm is described in Dennis and Schnabel. It is used as the default line search for the quasi-Newton algorithms, although it might not be the best technique for all problems.

### Algorithms

`srchbac` locates the minimum of the performance function in the search direction  $dX$ , using the backtracking algorithm described on page 126 and 328 of Dennis and Schnabel's book, noted below.

### References

Dennis, J.E., and R.B. Schnabel, *Numerical Methods for Unconstrained Optimization and Nonlinear Equations*, Englewood Cliffs, NJ, Prentice-Hall, 1983

### See Also

`srchcha` | `srchgol` | `srchhyb`

**Introduced before R2006a**

## srchbre

1-D interval location using Brent's method

### Syntax

```
[a,gX,perf,retcode,delta,tol] =
srchbre(net,X,Pd,Tl,Ai,Q,TS,dX,gX,perf,dperf,delta,tol,ch_perf)
```

### Description

srchbre is a linear search routine. It searches in a given direction to locate the minimum of the performance function in that direction. It uses a technique called Brent's technique.

[a,gX,perf,retcode,delta,tol] = srchbre(net,X,Pd,Tl,Ai,Q,TS,dX,gX,perf,dperf,delta,tol,ch\_perf) takes these inputs,

net	Neural network
X	Vector containing current values of weights and biases
Pd	Delayed input vectors
Tl	Layer target vectors
Ai	Initial input delay conditions
Q	Batch size
TS	Time steps
dX	Search direction vector
gX	Gradient vector
perf	Performance value at current X
dperf	Slope of performance value at current X in direction of dX
delta	Initial step size
tol	Tolerance on search
ch_perf	Change in performance on previous step

and returns

a	Step size that minimizes performance
gX	Gradient at new minimum point
perf	Performance value at new minimum point
retcode	Return code that has three elements. The first two elements correspond to the number of function evaluations in the two stages of the search. The third element is a return code. These have different meanings for different search algorithms. Some might not be used in this function.

	0 Normal
	1 Minimum step taken
	2 Maximum step taken
	3 Beta condition not met
delta	New initial step size, based on the current step size
tol	New tolerance on search

Parameters used for the Brent algorithm are

alpha	Scale factor that determines sufficient reduction in perf
beta	Scale factor that determines sufficiently large step size
bmax	Largest step size
scale_tol	Parameter that relates the tolerance tol to the initial step size delta, usually set to 20

The defaults for these parameters are set in the training function that calls them. See `traincgf`, `traincgb`, `traincgp`, `trainbfg`, and `trainoss`.

Dimensions for these variables are

Pd	No-by-Ni-by-TS cell array	Each element $P\{i, j, ts\}$ is a $D_{ij}$ -by-Q matrix.
Tl	Nl-by-TS cell array	Each element $P\{i, ts\}$ is a $V_i$ -by-Q matrix.
Ai	Nl-by-LD cell array	Each element $A_i\{i, k\}$ is an $S_i$ -by-Q matrix.

where

Ni	=	<code>net.numInputs</code>
Nl	=	<code>net.numLayers</code>
LD	=	<code>net.numLayerDelays</code>
Ri	=	<code>net.inputs{i}.size</code>
Si	=	<code>net.layers{i}.size</code>
Vi	=	<code>net.targets{i}.size</code>
Dij	=	<code>Ri * length(net.inputWeights{i,j}.delays)</code>

## More About

### Brent's Search

Brent's search is a linear search that is a hybrid of the golden section search and a quadratic interpolation. Function comparison methods, like the golden section search, have a first-order rate of convergence, while polynomial interpolation methods have an asymptotic rate that is faster than superlinear. On the other hand, the rate of convergence for the golden section search starts when the algorithm is initialized, whereas the asymptotic behavior for the polynomial interpolation methods can take many iterations to become apparent. Brent's search attempts to combine the best features of both approaches.

For Brent's search, you begin with the same interval of uncertainty used with the golden section search, but some additional points are computed. A quadratic function is then fitted to these points and the minimum of the quadratic function is computed. If this minimum is within the appropriate interval of uncertainty, it is used in the next stage of the search and a new quadratic approximation is performed. If the minimum falls outside the known interval of uncertainty, then a step of the golden section search is performed.

See [Bren73] for a complete description of this algorithm. This algorithm has the advantage that it does not require computation of the derivative. The derivative computation requires a backpropagation through the network, which involves more computation than a forward pass. However, the algorithm can require more performance evaluations than algorithms that use derivative information.

## Algorithms

srchbre brackets the minimum of the performance function in the search direction  $dX$ , using Brent's algorithm, described on page 46 of Scales (see reference below). It is a hybrid algorithm based on the golden section search and the quadratic approximation.

## References

Scales, L.E., *Introduction to Non-Linear Optimization*, New York, Springer-Verlag, 1985

## See Also

srchbac | srchcha | srchgol | srchhyb

**Introduced before R2006a**

## srchcha

1-D minimization using Charalambous' method

### Syntax

```
[a,gX,perf,retcode,delta,tol] =
srchcha(net,X,Pd,Tl,Ai,Q,TS,dX,gX,perf,dperf,delta,tol,ch_perf)
```

### Description

srchcha is a linear search routine. It searches in a given direction to locate the minimum of the performance function in that direction. It uses a technique based on Charalambous' method.

[a,gX,perf,retcode,delta,tol] = srchcha(net,X,Pd,Tl,Ai,Q,TS,dX,gX,perf,dperf,delta,tol,ch\_perf) takes these inputs,

net	Neural network
X	Vector containing current values of weights and biases
Pd	Delayed input vectors
Tl	Layer target vectors
Ai	Initial input delay conditions
Q	Batch size
TS	Time steps
dX	Search direction vector
gX	Gradient vector
perf	Performance value at current X
dperf	Slope of performance value at current X in direction of dX
delta	Initial step size
tol	Tolerance on search
ch_perf	Change in performance on previous step

and returns

a	Step size that minimizes performance
gX	Gradient at new minimum point
perf	Performance value at new minimum point
retcode	Return code that has three elements. The first two elements correspond to the number of function evaluations in the two stages of the search. The third element is a return code. These have different meanings for different search algorithms. Some might not be used in this function.



	0 Normal
	1 Minimum step taken
	2 Maximum step taken
	3 Beta condition not met
delta	New initial step size, based on the current step size
tol	New tolerance on search

Parameters used for the Charalambous algorithm are

alpha	Scale factor that determines sufficient reduction in perf
beta	Scale factor that determines sufficiently large step size
gama	Parameter to avoid small reductions in performance, usually set to 0.1
scale_tol	Parameter that relates the tolerance tol to the initial step size delta, usually set to 20

The defaults for these parameters are set in the training function that calls them. See `traincgf`, `traincgb`, `traincgp`, `trainbfg`, and `trainoss`.

Dimensions for these variables are

Pd	No-by-Ni-by-TS cell array	Each element $P\{i, j, ts\}$ is a $D_{ij}$ -by- $Q$ matrix.
Tl	Nl-by-TS cell array	Each element $P\{i, ts\}$ is a $V_i$ -by- $Q$ matrix.
Ai	Nl-by-LD cell array	Each element $A_i\{i, k\}$ is an $S_i$ -by- $Q$ matrix.

where

Ni	=	<code>net.numInputs</code>
Nl	=	<code>net.numLayers</code>
LD	=	<code>net.numLayerDelays</code>
Ri	=	<code>net.inputs{i}.size</code>
Si	=	<code>net.layers{i}.size</code>
Vi	=	<code>net.targets{i}.size</code>
Dij	=	<code>Ri * length(net.inputWeights{i,j}.delays)</code>

## More About

### Charalambous' Search

The method of Charalambous, `srchcha`, was designed to be used in combination with a conjugate gradient algorithm for neural network training. Like `srchbre` and `srchhyb`, it is a hybrid search. It uses a cubic interpolation together with a type of sectioning.

See [Char92] for a description of Charalambous' search. This routine is used as the default search for most of the conjugate gradient algorithms because it appears to produce excellent results for many different problems. It does require the computation of the derivatives (backpropagation) in addition to the computation of performance, but it overcomes this limitation by locating the minimum with

fewer steps. This is not true for all problems, and you might want to experiment with other line searches.

### Algorithms

`srchcha` locates the minimum of the performance function in the search direction  $dX$ , using an algorithm based on the method described in Charalambous (see reference below).

### References

Charalambous, C., "Conjugate gradient algorithm for efficient training of artificial neural networks," *IEEE Proceedings*, Vol. 139, No. 3, June, 1992, pp. 301-310.

### See Also

`srchbac` | `srchbre` | `srchgol` | `srchhyb`

**Introduced before R2006a**

# srchgol

1-D minimization using golden section search

## Syntax

```
[a,gX,perf,retcode,delta,tol] =
srchgol(net,X,Pd,Tl,Ai,Q,TS,dX,gX,perf,dperf,delta,tol,ch_perf)
```

## Description

srchgol is a linear search routine. It searches in a given direction to locate the minimum of the performance function in that direction. It uses a technique called the golden section search.

[a,gX,perf,retcode,delta,tol] = srchgol(net,X,Pd,Tl,Ai,Q,TS,dX,gX,perf,dperf,delta,tol,ch\_perf) takes these inputs,

net	Neural network
X	Vector containing current values of weights and biases
Pd	Delayed input vectors
Tl	Layer target vectors
Ai	Initial input delay conditions
Q	Batch size
TS	Time steps
dX	Search direction vector
gX	Gradient vector
perf	Performance value at current X
dperf	Slope of performance value at current X in direction of dX
delta	Initial step size
tol	Tolerance on search
ch_perf	Change in performance on previous step

and returns

a	Step size that minimizes performance
gX	Gradient at new minimum point
perf	Performance value at new minimum point
retcode	Return code that has three elements. The first two elements correspond to the number of function evaluations in the two stages of the search. The third element is a return code. These have different meanings for different search algorithms. Some might not be used in this function.

	0 Normal
	1 Minimum step taken
	2 Maximum step taken
	3 Beta condition not met
delta	New initial step size, based on the current step size
tol	New tolerance on search

Parameters used for the golden section algorithm are

alpha	Scale factor that determines sufficient reduction in perf
bmax	Largest step size
scale_tol	Parameter that relates the tolerance tol to the initial step size delta, usually set to 20

The defaults for these parameters are set in the training function that calls them. See `traincgf`, `traincgb`, `traincgp`, `trainbfg`, and `trainoss`.

Dimensions for these variables are

Pd	No-by-Ni-by-TS cell array	Each element $P\{i, j, ts\}$ is a $D_{ij}$ -by-Q matrix.
Tl	Nl-by-TS cell array	Each element $P\{i, ts\}$ is a $V_i$ -by-Q matrix.
Ai	Nl-by-LD cell array	Each element $A_i\{i, k\}$ is an $S_i$ -by-Q matrix.

where

Ni	=	<code>net.numInputs</code>
Nl	=	<code>net.numLayers</code>
LD	=	<code>net.numLayerDelays</code>
Ri	=	<code>net.inputs{i}.size</code>
Si	=	<code>net.layers{i}.size</code>
Vi	=	<code>net.targets{i}.size</code>
Dij	=	<code>Ri * length(net.inputWeights{i,j}.delays)</code>

## More About

### Golden Section Search

The golden section search `srchgol` is a linear search that does not require the calculation of the slope. This routine begins by locating an interval in which the minimum of the performance function occurs. This is accomplished by evaluating the performance at a sequence of points, starting at a distance of `delta` and doubling in distance each step, along the search direction. When the performance increases between two successive iterations, a minimum has been bracketed. The next step is to reduce the size of the interval containing the minimum. Two new points are located within the initial interval. The values of the performance at these two points determine a section of the interval that can be discarded, and a new interior point is placed within the new interval. This procedure is continued until the interval of uncertainty is reduced to a width of `tol`, which is equal to `delta/scale_tol`.

See [HDB96], starting on page 12-16, for a complete description of the golden section search. Try the *Neural Network Design* demonstration `nnd12sd1` [HDB96] for an illustration of the performance of the golden section search in combination with a conjugate gradient algorithm.

## Algorithms

`srchgol` locates the minimum of the performance function in the search direction  $dX$ , using the golden section search. It is based on the algorithm as described on page 33 of Scales (see reference below).

## References

Scales, L.E., *Introduction to Non-Linear Optimization*, New York, Springer-Verlag, 1985

## See Also

`srchbac` | `srchbre` | `srchcha` | `srchhyb`

**Introduced before R2006a**

## srchhyb

1-D minimization using a hybrid bisection-cubic search

### Syntax

```
[a,gX,perf,retcode,delta,tol] =
srchhyb(net,X,Pd,Tl,Ai,Q,TS,dX,gX,perf,dperf,delta,tol,ch_perf)
```

### Description

srchhyb is a linear search routine. It searches in a given direction to locate the minimum of the performance function in that direction. It uses a technique that is a combination of a bisection and a cubic interpolation.

[a,gX,perf,retcode,delta,tol] = srchhyb(net,X,Pd,Tl,Ai,Q,TS,dX,gX,perf,dperf,delta,tol,ch\_perf) takes these inputs,

net	Neural network
X	Vector containing current values of weights and biases
Pd	Delayed input vectors
Tl	Layer target vectors
Ai	Initial input delay conditions
Q	Batch size
TS	Time steps
dX	Search direction vector
gX	Gradient vector
perf	Performance value at current X
dperf	Slope of performance value at current X in direction of dX
delta	Initial step size
tol	Tolerance on search
ch_perf	Change in performance on previous step

and returns

a	Step size that minimizes performance
gX	Gradient at new minimum point
perf	Performance value at new minimum point

retcode	Return code that has three elements. The first two elements correspond to the number of function evaluations in the two stages of the search. The third element is a return code. These have different meanings for different search algorithms. Some might not be used in this function.
	0 Normal
	1 Minimum step taken
	2 Maximum step taken
	3 Beta condition not met
delta	New initial step size, based on the current step size
tol	New tolerance on search

Parameters used for the hybrid bisection-cubic algorithm are

alpha	Scale factor that determines sufficient reduction in perf
beta	Scale factor that determines sufficiently large step size
bmax	Largest step size
scale_tol	Parameter that relates the tolerance tol to the initial step size delta, usually set to 20

The defaults for these parameters are set in the training function that calls them. See `traincgf`, `traincgb`, `traincgp`, `trainbfg`, and `trainoss`.

Dimensions for these variables are

Pd	No-by-Ni-by-TS cell array	Each element $P\{i, j, ts\}$ is a $D_{ij}$ -by-Q matrix.
Tl	Nl-by-TS cell array	Each element $P\{i, ts\}$ is a $V_i$ -by-Q matrix.
Ai	Nl-by-LD cell array	Each element $A_i\{i, k\}$ is an $S_i$ -by-Q matrix.

where

Ni	=	<code>net.numInputs</code>
Nl	=	<code>net.numLayers</code>
LD	=	<code>net.numLayerDelays</code>
Ri	=	<code>net.inputs{i}.size</code>
Si	=	<code>net.layers{i}.size</code>
Vi	=	<code>net.targets{i}.size</code>
Dij	=	<code>Ri * length(net.inputWeights{i,j}.delays)</code>

## More About

### Hybrid Bisection Cubic Search

Like Brent's search, `srchhyb` is a hybrid algorithm. It is a combination of bisection and cubic interpolation. For the bisection algorithm, one point is located in the interval of uncertainty, and the

performance and its derivative are computed. Based on this information, half of the interval of uncertainty is discarded. In the hybrid algorithm, a cubic interpolation of the function is obtained by using the value of the performance and its derivative at the two endpoints. If the minimum of the cubic interpolation falls within the known interval of uncertainty, then it is used to reduce the interval of uncertainty. Otherwise, a step of the bisection algorithm is used.

See [Scal85] for a complete description of the hybrid bisection-cubic search. This algorithm does require derivative information, so it performs more computations at each step of the algorithm than the golden section search or Brent's algorithm.

### Algorithms

`srchhyb` locates the minimum of the performance function in the search direction  $dX$ , using the hybrid bisection-cubic interpolation algorithm described on page 50 of Scales (see reference below).

### References

Scales, L.E., *Introduction to Non-Linear Optimization*, New York Springer-Verlag, 1985

### See Also

`srchbac` | `srchbre` | `srchcha` | `srchgol`

**Introduced before R2006a**



## sse

Sum squared error performance function

### Syntax

```
perf = sse(net,t,y,ew)
[...] = sse(...,'regularization',regularization)
[...] = sse(...,'normalization',normalization)
[...] = sse(...,FP)
```

### Description

`sse` is a network performance function. It measures performance according to the sum of squared errors.

`perf = sse(net,t,y,ew)` takes these input arguments and optional function parameters,

<code>net</code>	Neural network
<code>t</code>	Matrix or cell array of target vectors
<code>y</code>	Matrix or cell array of output vectors
<code>ew</code>	Error weights (default = {1})

and returns the sum squared error.

This function has two optional function parameters which can be defined with parameter name/pair arguments, or as a structure `FP` argument with fields having the parameter name and assigned the parameter values.

```
[...] = sse(...,'regularization',regularization)
```

```
[...] = sse(...,'normalization',normalization)
```

```
[...] = sse(...,FP)
```

- `regularization` — can be set to any value between the default of 0 and 1. The greater the regularization value, the more squared weights and biases are taken into account in the performance calculation.
- `normalization`
  - `'none'` — performs no normalization, the default.
  - `'standard'` — normalizes outputs and targets to [-1, +1], and therefore normalizes errors to [-2, +2].
  - `'percent'` — normalizes outputs and targets to [-0.5, +0.5], and therefore normalizes errors to [-1, +1].

### Examples

Here a network is trained to fit a simple data set and its performance calculated

```
[x,t] = simplefit_dataset;  
net = fitnet(10);  
net.performFcn = 'sse';  
net = train(net,x,t)  
y = net(x)  
e = t-y  
perf = sse(net,t,y)
```

### **Network Use**

To prepare a custom network to be trained with `sse`, set `net.performFcn` to `'sse'`. This automatically sets `net.performParam` to the default function parameters.

Then calling `train`, `adapt` or `perform` will result in `sse` being used to calculate performance.

**Introduced before R2006a**

# staticderiv

Static derivative function

## Syntax

```
staticderiv('dperf_dwb',net,X,T,Xi,Ai,EW)
staticderiv('de_dwb',net,X,T,Xi,Ai,EW)
```

## Description

This function calculates derivatives using the chain rule from the networks performance or outputs back to its inputs. For time series data and dynamic networks this function ignores the delay connections resulting in a approximation (which may be good or not) of the actual derivative. This function is used by Elman networks (elmnet) which is a dynamic network trained by the static derivative approximation when full derivative calculations are not available. As full derivatives are calculated by all the other derivative functions, this function is not recommended for dynamic networks except for research into training algorithms.

`staticderiv('dperf_dwb',net,X,T,Xi,Ai,EW)` takes these arguments,

<code>net</code>	Neural network
<code>X</code>	Inputs, an $R \times Q$ matrix (or $N \times TS$ cell array of $R \times Q$ matrices)
<code>T</code>	Targets, an $S \times Q$ matrix (or $M \times TS$ cell array of $S \times Q$ matrices)
<code>Xi</code>	Initial input delay states (optional)
<code>Ai</code>	Initial layer delay states (optional)
<code>EW</code>	Error weights (optional)

and returns the gradient of performance with respect to the network's weights and biases, where  $R$  and  $S$  are the number of input and output elements and  $Q$  is the number of samples (and  $N$  and  $M$  are the number of input and output signals,  $R_i$  and  $S_i$  are the number of each input and outputs elements, and  $TS$  is the number of timesteps).

`staticderiv('de_dwb',net,X,T,Xi,Ai,EW)` returns the Jacobian of errors with respect to the network's weights and biases.

## Examples

Here a feedforward network is trained and both the gradient and Jacobian are calculated.

```
[x,t] = simplefit_dataset;
net = feedforwardnet(20);
net = train(net,x,t);
y = net(x);
perf = perform(net,t,y);
gwb = staticderiv('dperf_dwb',net,x,t)
jwb = staticderiv('de_dwb',net,x,t)
```

**See Also**

`bttderiv` | `defaultderiv` | `fpderiv` | `num2deriv`

**Introduced in R2010b**

# sumabs

Sum of absolute elements of matrix or matrices

## Syntax

```
[s,n] = sumabs(x)
```

## Description

`[s,n] = sumabs(x)` takes a matrix or cell array of matrices and returns,

s	Sum of all absolute finite values
n	Number of finite values

If `x` contains no finite values, the sum returned is 0.

## Examples

```
m = sumabs([1 2;3 4])  
[m,n] = sumabs({[1 2; NaN 4], [4 5; 2 3]})
```

## See Also

`meanabs` | `meansqr` | `sumsqr`

**Introduced in R2010b**

## sumsqr

Sum of squared elements of matrix or matrices

### Syntax

```
[s,n] = sumsqr(x)
```

### Description

[s,n] = sumsqr(x) takes a matrix or cell array of matrices and returns,

s	Sum of all squared finite values
n	Number of finite values

If x contains no finite values, the sum returned is 0.

### Examples

```
m = sumsqr([1 2;3 4])  
[m,n] = sumsqr({[1 2; NaN 4], [4 5; 2 3]})
```

### See Also

meanabs | meansqr | sumabs

**Introduced before R2006a**

## tansig

Hyperbolic tangent sigmoid transfer function

### Graph and Symbol

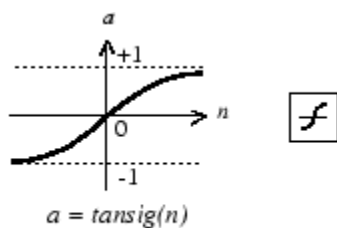

Tan-Sigmoid Transfer Function

### Syntax

$A = \text{tansig}(N, FP)$

### Description

tansig is a neural transfer function. Transfer functions calculate a layer's output from its net input.

$A = \text{tansig}(N, FP)$  takes  $N$  and optional function parameters,

$N$	$S$ -by- $Q$ matrix of net input (column) vectors
$FP$	Struct of function parameters (ignored)

and returns  $A$ , the  $S$ -by- $Q$  matrix of  $N$ 's elements squashed into  $[-1 \ 1]$ .

### Examples

Here is the code to create a plot of the tansig transfer function.

```
n = -5:0.1:5;
a = tansig(n);
plot(n,a)
```

Assign this transfer function to layer  $i$  of a network.

```
net.layers{i}.transferFcn = 'tansig';
```

### Algorithms

$a = \text{tansig}(n) = 2 / (1 + \exp(-2*n)) - 1$

This is mathematically equivalent to  $\tanh(N)$ . It differs in that it runs faster than the MATLAB implementation of  $\tanh$ , but the results can have very small numerical differences. This function is a good tradeoff for neural networks, where speed is important and the exact shape of the transfer function is not.

## References

Vogl, T.P., J.K. Mangis, A.K. Rigler, W.T. Zink, and D.L. Alkon, "Accelerating the convergence of the backpropagation method," *Biological Cybernetics*, Vol. 59, 1988, pp. 257-263

## See Also

logsig | sim

**Introduced before R2006a**



# tapdelay

Shift neural network time series data for tap delay

## Syntax

```
tapdelay(x,i,ts,delays)
```

## Description

tapdelay(x,i,ts,delays) takes these arguments,

x	Neural network time series data
i	Signal index
ts	Timestep index
delays	Row vector of increasing zero or positive delays

and returns the tap delay values of signal *i* at timestep *ts* given the specified tap delays.

## Examples

Here a random signal *x* consisting of eight timesteps is defined, and a tap delay with delays of [0 1 4] is simulated at timestep 6.

```
x = num2cell(rand(1,8));  
y = tapdelay(x,1,6,[0 1 4])
```

## See Also

extendts | nndata | preparets

**Introduced in R2010b**

## timedelaynet

Time delay neural network

### Syntax

```
timedelaynet(inputDelays,hiddenSizes,trainFcn)
```

### Description

Time delay networks are similar to feedforward networks, except that the input weight has a tap delay line associated with it. This allows the network to have a finite dynamic response to time series input data. This network is also similar to the distributed delay neural network (`distdelaynet`), which has delays on the layer weights in addition to the input weight.

`timedelaynet(inputDelays,hiddenSizes,trainFcn)` takes these arguments,

<code>inputDelays</code>	Row vector of increasing 0 or positive delays (default = 1:2)
<code>hiddenSizes</code>	Row vector of one or more hidden layer sizes (default = 10)
<code>trainFcn</code>	Training function (default = 'trainlm')

and returns a time delay neural network.

### Examples

#### Train Time Delay Network and Predict on New Data

Partition the training set. Use `Xnew` to do prediction in closed loop mode later.

```
[X,T] = simpleseries_dataset;
Xnew = X(81:100);
X = X(1:80);
T = T(1:80);
```

Train a time delay network, and simulate it on the first 80 observations.

```
net = timedelaynet(1:2,10);
[Xs,Xi,Ai,Ts] = preparets(net,X,T);
net = train(net,Xs,Ts,Xi,Ai);
view(net)
```

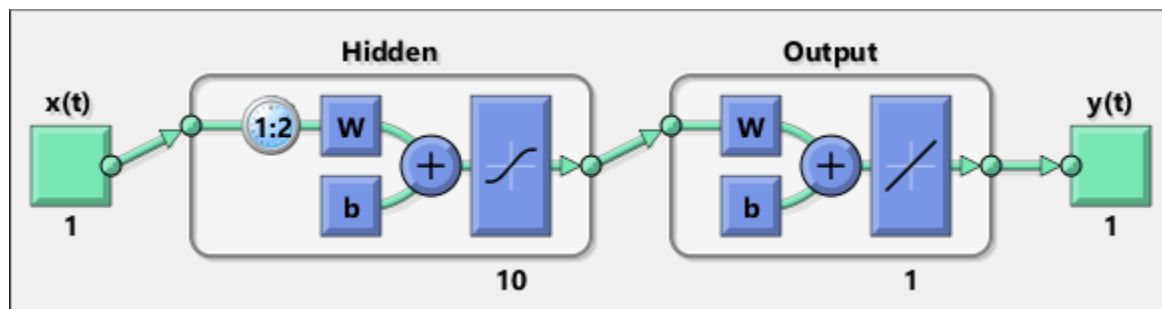

Calculate the network performance.

```
[Y,Xf,Af] = net(Xs,Xi,Ai);  
perf = perform(net,Ts,Y);
```

Run the prediction for 20 timesteps ahead in closed loop mode.

```
[netc,Xic,Aic] = closeloop(net,Xf,Af);  
view(netc)
```

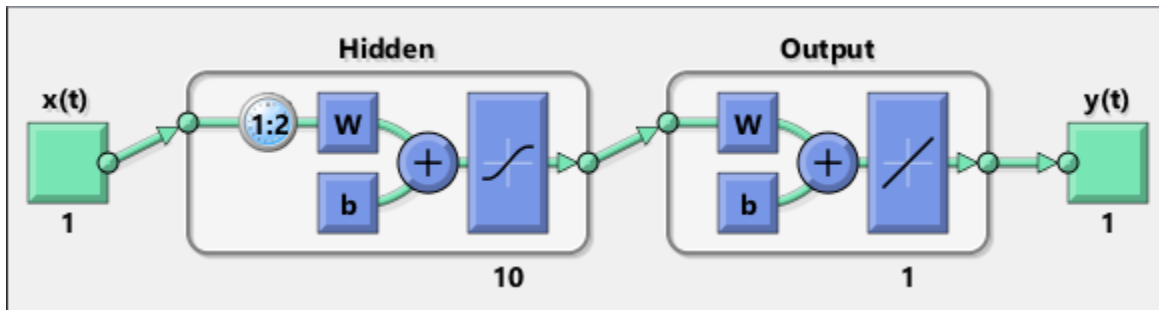

```
y2 = netc(Xnew,Xic,Aic);
```

## See Also

[distdelaynet](#) | [narnet](#) | [narxnet](#) | [preparets](#) | [removedelay](#)

**Introduced in R2010b**

## tonndata

Convert data to standard neural network cell array form

### Syntax

```
[y,wasMatrix] = tonndata(x,columnSamples,cellTime)
```

### Description

[y,wasMatrix] = tonndata(x,columnSamples,cellTime) takes these arguments,

x	Matrix or cell array of matrices
columnSamples	True if original samples are oriented as columns, false if rows
cellTime	True if original samples are columns of a cell array, false if they are stored in a matrix

and returns

y	Original data transformed into standard neural network cell array form
wasMatrix	True if original data was a matrix (as opposed to cell array)

If `columnSamples` is false, then matrix `x` or matrices in cell array `x` will be transposed, so row samples will now be stored as column vectors.

If `cellTime` is false, then matrix samples will be separated into columns of a cell array so time originally represented as vectors in a matrix will now be represented as columns of a cell array.

The returned value `wasMatrix` can be used by `fromnndata` to reverse the transformation.

### Examples

Here data consisting of six timesteps of 5-element vectors, originally represented as a matrix with six columns, is converted to standard neural network representation and back.

```
x = rand(5,6)
columnSamples = true; % samples are by columns.
cellTime = false; % time-steps in matrix, not cell array.
[y,wasMatrix] = tonndata(x,columnSamples,cellTime)
x2 = fromnndata(y,wasMatrix,columnSamples,cellTime)
```

### See Also

`fromnndata` | `nndata` | `nndata2sim` | `sim2nndata`

Introduced in R2010b

# train

Train shallow neural network

## Syntax

```
trainedNet = train(net,X,T,Xi,Ai,EW)
[trainedNet,tr] = train(net,X,T,Xi,Ai,EW)
[trainedNet,tr] = train(net,X,T,Xi,Ai,EW,Name,Value)
```

## Description

This function trains a shallow neural network. For deep learning with convolutional or LSTM neural networks, see `trainNetwork` instead.

`trainedNet = train(net,X,T,Xi,Ai,EW)` trains a network `net` according to `net.trainFcn` and `net.trainParam`.

`[trainedNet,tr] = train(net,X,T,Xi,Ai,EW)` also returns a training record.

`[trainedNet,tr] = train(net,X,T,Xi,Ai,EW,Name,Value)` trains a network with additional options specified by one or more name-value pair arguments.

## Examples

### Train and Plot Networks

Here input `x` and targets `t` define a simple function that you can plot:

```
x = [0 1 2 3 4 5 6 7 8];
t = [0 0.84 0.91 0.14 -0.77 -0.96 -0.28 0.66 0.99];
plot(x,t,'o')
```

Here `feedforwardnet` creates a two-layer feed-forward network. The network has one hidden layer with ten neurons.

```
net = feedforwardnet(10);
net = configure(net,x,t);
y1 = net(x)
plot(x,t,'o',x,y1,'x')
```

The network is trained and then resimulated.

```
net = train(net,x,t);
y2 = net(x)
plot(x,t,'o',x,y1,'x',x,y2,'*')
```

### Train NARX Time Series Network

This example trains an open-loop nonlinear-autoregressive network with external input, to model a levitated magnet system defined by a control current `x` and the magnet's vertical position response `t`,

then simulates the network. The function `preparets` prepares the data before training and simulation. It creates the open-loop network's combined inputs `xo`, which contains both the external input `x` and previous values of position `t`. It also prepares the delay states `xi`.

```
[x,t] = maglev_dataset;
net = narxnet(10);
[xo,xi,~,to] = preparets(net,x,{},t);
net = train(net,xo,to,xi);
y = net(xo,xi)
```

This same system can also be simulated in closed-loop form.

```
netc = closeloop(net);
view(netc)
[xc,xi,ai,tc] = preparets(netc,x,{},t);
yc = netc(xc,xi,ai);
```

### Train a Network in Parallel on a Parallel Pool

Parallel Computing Toolbox allows Deep Learning Toolbox to simulate and train networks faster and on larger datasets than can fit on one PC. Parallel training is currently supported for backpropagation training only, not for self-organizing maps.

Here training and simulation happens across parallel MATLAB workers.

```
parpool
[X,T] = vinyl_dataset;
net = feedforwardnet(10);
net = train(net,X,T,'useParallel','yes','showResources','yes');
Y = net(X);
```

Use Composite values to distribute the data manually, and get back the results as a Composite value. If the data is loaded as it is distributed then while each piece of the dataset must fit in RAM, the entire dataset is limited only by the total RAM of all the workers.

```
[X,T] = vinyl_dataset;
Q = size(X,2);
Xc = Composite;
Tc = Composite;
numWorkers = numel(Xc);
ind = [0 ceil((1:numWorkers)*(Q/numWorkers))];
for i=1:numWorkers
    indi = (ind(i)+1):ind(i+1);
    Xc{i} = X(:,indi);
    Tc{i} = T(:,indi);
end
net = feedforwardnet;
net = configure(net,X,T);
net = train(net,Xc,Tc);
Yc = net(Xc);
```

Note in the example above the function `configure` was used to set the dimensions and processing settings of the network's inputs. This normally happens automatically when `train` is called, but when providing composite data this step must be done manually with non-Composite data.

## Train a Network on GPUs

Networks can be trained using the current GPU device, if it is supported by Parallel Computing Toolbox. GPU training is currently supported for backpropagation training only, not for self-organizing maps.

```
[X,T] = vinyl_dataset;
net = feedforwardnet(10);
net = train(net,X,T,'useGPU','yes');
y = net(X);
```

To put the data on a GPU manually:

```
[X,T] = vinyl_dataset;
Xgpu = gpuArray(X);
Tgpu = gpuArray(T);
net = configure(net,X,T);
net = train(net,Xgpu,Tgpu);
Ygpu = net(Xgpu);
Y = gather(Ygpu);
```

Note in the example above the function `configure` was used to set the dimensions and processing settings of the network's inputs. This normally happens automatically when `train` is called, but when providing `gpuArray` data this step must be done manually with non-`gpuArray` data.

To run in parallel, with workers each assigned to a different unique GPU, with extra workers running on CPU:

```
net = train(net,X,T,'useParallel','yes','useGPU','yes');
y = net(X);
```

Using only workers with unique GPUs might result in higher speed, as CPU workers might not keep up.

```
net = train(net,X,T,'useParallel','yes','useGPU','only');
Y = net(X);
```

## Train Network Using Checkpoint Saves

Here a network is trained with checkpoints saved at a rate no greater than once every two minutes.

```
[x,t] = vinyl_dataset;
net = fitnet([60 30]);
net = train(net,x,t,'CheckpointFile','MyCheckpoint','CheckpointDelay',120);
```

After a computer failure, the latest network can be recovered and used to continue training from the point of failure. The checkpoint file includes a structure variable `checkpoint`, which includes the network, training record, filename, time, and number.

```
[x,t] = vinyl_dataset;
load MyCheckpoint
net = checkpoint.net;
net = train(net,x,t,'CheckpointFile','MyCheckpoint');
```

Another use for the checkpoint feature is when you stop a parallel training session (started with the `'UseParallel'` parameter) even though the Neural Network Training Tool is not available during

parallel training. In this case, set a 'CheckpointFile', use Ctrl+C to stop training any time, then load your checkpoint file to get the network and training record.

## Input Arguments

### **net** — Input network

network object

Input network, specified as a network object. To create a network object, use for example, `feedforwardnet` or `narxnet`.

### **X** — Network inputs

matrix | cell array | composite data | gpuArray

Network inputs, specified as an R-by-Q matrix or an Ni-by-TS cell array, where

- R is the input size
- Q is the batch size
- $N_i = \text{net.numInputs}$
- TS is the number of time steps

`train` arguments can have two formats: matrices, for static problems and networks with single inputs and outputs, and cell arrays for multiple timesteps and networks with multiple inputs and outputs.

- The matrix format can be used if only one time step is to be simulated ( $TS = 1$ ). It is convenient for networks with only one input and output, but can be used with networks that have more. When the network has multiple inputs, the matrix size is (sum of  $R_i$ )-by-Q.
- The cell array format is more general, and more convenient for networks with multiple inputs and outputs, allowing sequences of inputs to be presented. Each element  $X\{i, ts\}$  is an  $R_i$ -by-Q matrix, where  $R_i = \text{net.inputs}\{i\}.size$ .

If Composite data is used, then 'useParallel' is automatically set to 'yes'. The function takes Composite data and returns Composite results.

If gpuArray data is used, then 'useGPU' is automatically set to 'yes'. The function takes gpuArray data and returns gpuArray results

---

**Note** If a column of X contains at least one NaN, `train` does not use that column for training, testing, or validation. If a target value in T is a NaN, then `train` ignores that row, and uses the other rows for training, testing, or validation.

---

### **T** — Network targets

zeros (default) | matrix | cell array | composite data | gpuArray

Network targets, specified as a U-by-Q matrix or an No-by-TS cell array, where

- U is the output size
- Q is the batch size
- $N_o = \text{net.numOutputs}$



- TS is the number of time steps

`train` arguments can have two formats: matrices, for static problems and networks with single inputs and outputs, and cell arrays for multiple timesteps and networks with multiple inputs and outputs.

- The matrix format can be used if only one time step is to be simulated ( $TS = 1$ ). It is convenient for networks with only one input and output, but can be used with networks that have more. When the network has multiple inputs, the matrix size is (sum of  $U_i$ )-by- $Q$ .
- The cell array format is more general, and more convenient for networks with multiple inputs and outputs, allowing sequences of inputs to be presented. Each element  $T\{i, ts\}$  is a  $U_i$ -by- $Q$  matrix, where  $U_i = \text{net.outputs}\{i\}.\text{size}$ .

If Composite data is used, then `'useParallel'` is automatically set to `'yes'`. The function takes Composite data and returns Composite results.

If `gpuArray` data is used, then `'useGPU'` is automatically set to `'yes'`. The function takes `gpuArray` data and returns `gpuArray` results

Note that `T` is optional and need only be used for networks that require targets.

---

**Note** Any NaN values in the inputs  $X$  or the targets  $T$ , are treated as missing data. If a column of  $X$  or  $T$  contains at least one NaN, that column is not used for training, testing, or validation.

---

### **$X_i$ – Initial input delay conditions**

zeros (default) | cell array | matrix

Initial input delay conditions, specified as an  $N_i$ -by- $ID$  cell array or an  $R$ -by- $(ID*Q)$  matrix, where

- $ID = \text{net.numInputDelays}$
- $N_i = \text{net.numInputs}$
- $R$  is the input size
- $Q$  is the batch size

For cell array input, the columns of  $X_i$  are ordered from the oldest delay condition to the most recent:  $X_i\{i, k\}$  is the input  $i$  at time  $ts = k - ID$ .

$X_i$  is also optional and need only be used for networks that have input or layer delays.

### **$A_i$ – Initial layer delay conditions**

zeros (default) | cell array | matrix

Initial layer delay conditions, specified as a  $N_l$ -by- $LD$  cell array or a (sum of  $S_i$ )-by- $(LD*Q)$  matrix, where

- $N_l = \text{net.numLayers}$
- $LD = \text{net.numLayerDelays}$
- $S_i = \text{net.layers}\{i\}.\text{size}$
- $Q$  is the batch size

For cell array input, the columns of  $A_i$  are ordered from the oldest delay condition to the most recent:  $A_i\{i, k\}$  is the layer output  $i$  at time  $t_s = k - LD$ .

### **EW — Error weights**

cell array

Error weights, specified as a  $N_o$ -by- $T_S$  cell array or a (sum of  $U_i$ )-by- $Q$  matrix, where

- $N_o = \text{net.numOutputs}$
- $T_S$  is the number of time steps
- $U_i = \text{net.outputs}\{i\}.\text{size}$
- $Q$  is the batch size

For cell array input. each element  $EW\{i, t_s\}$  is a  $U_i$ -by- $Q$  matrix, where

- $U_i = \text{net.outputs}\{i\}.\text{size}$
- $Q$  is the batch size

The error weights  $EW$  can also have a size of 1 in place of all or any of  $N_o$ ,  $T_S$ ,  $U_i$  or  $Q$ . In that case,  $EW$  is automatically dimension extended to match the targets  $T$ . This allows for conveniently weighting the importance in any dimension (such as per sample) while having equal importance across another (such as time, with  $T_S=1$ ). If all dimensions are 1, for instance if  $EW = \{1\}$ , then all target values are treated with the same importance. That is the default value of  $EW$ .

As noted above, the error weights  $EW$  can be of the same dimensions as the targets  $T$ , or have some dimensions set to 1. For instance if  $EW$  is 1-by- $Q$ , then target samples will have different importances, but each element in a sample will have the same importance. If  $EW$  is (sum of  $U_i$ )-by-1, then each output element has a different importance, with all samples treated with the same importance.

### **Name-Value Pair Arguments**

Specify optional comma-separated pairs of **Name**, **Value** arguments. **Name** is the argument name and **Value** is the corresponding value. **Name** must appear inside quotes. You can specify several name and value pair arguments in any order as **Name1**, **Value1**, ..., **NameN**, **ValueN**.

Example: 'useParallel', 'yes'

### **useParallel — Option to specify parallel calculations**

'no' (default) | 'yes'

Option to specify parallel calculations, specified as 'yes' or 'no'.

- 'no' - Calculations occur on normal MATLAB thread. This is the default 'useParallel' setting.
- 'yes' - Calculations occur on parallel workers if a parallel pool is open. Otherwise calculations occur on the normal MATLAB thread.

### **useGPU — Option to specify GPU calculations**

'no' (default) | 'yes' | 'only'

Option to specify GPU calculations, specified as 'yes', 'no', or 'only'.

- 'no' - Calculations occur on the CPU. This is the default 'useGPU' setting.
- 'yes' - Calculations occur on the current `gpuDevice` if it is a supported GPU (See Parallel Computing Toolbox for GPU requirements.) If the current `gpuDevice` is not supported,

calculations remain on the CPU. If `'useParallel'` is also `'yes'` and a parallel pool is open, then each worker with a unique GPU uses that GPU, other workers run calculations on their respective CPU cores.

- `'only'` - If no parallel pool is open, then this setting is the same as `'yes'`. If a parallel pool is open then only workers with unique GPUs are used. However, if a parallel pool is open, but no supported GPUs are available, then calculations revert to performing on all worker CPUs.

### **showResources — Option to show resources**

`'no'` (default) | `'yes'`

Option to show resources, specified as `'yes'` or `'no'`.

- `'no'` - Do not display computing resources used at the command line. This is the default setting.
- `'yes'` - Show at the command line a summary of the computing resources actually used. The actual resources may differ from the requested resources, if parallel or GPU computing is requested but a parallel pool is not open or a supported GPU is not available. When parallel workers are used, each worker's computation mode is described, including workers in the pool that are not used.

### **reduction — Memory reduction**

1 (default) | positive integer

Memory reduction, specified as a positive integer.

For most neural networks, the default CPU training computation mode is a compiled MEX algorithm. However, for large networks the calculations might occur with a MATLAB calculation mode. This can be confirmed using `'showResources'`. If MATLAB is being used and memory is an issue, setting the reduction option to a value `N` greater than 1, reduces much of the temporary storage required to train by a factor of `N`, in exchange for longer training times.

### **CheckpointFile — Checkpoint file**

`''` (default) | character vector

Checkpoint file, specified as a character vector.

The value for `'CheckpointFile'` can be set to a filename to save in the current working folder, to a file path in another folder, or to an empty string to disable checkpoint saves (the default value).

### **CheckpointDelay — Checkpoint delay**

60 (default) | nonnegative integer

Checkpoint delay, specified as a nonnegative integer.

The optional parameter `'CheckpointDelay'` limits how often saves happen. Limiting the frequency of checkpoints can improve efficiency by keeping the amount of time saving checkpoints low compared to the time spent in calculations. It has a default value of 60, which means that checkpoint saves do not happen more than once per minute. Set the value of `'CheckpointDelay'` to 0 if you want checkpoint saves to occur only once every epoch.

## **Output Arguments**

### **trainedNet — Trained network**

network object

Trained network, returned as a `network` object.

**tr — Training record**

structure

Training record (epoch and perf), returned as a structure whose fields depend on the network training function (`net.NET.trainFcn`). It can include fields such as:

- Training, data division, and performance functions and parameters
- Data division indices for training, validation and test sets
- Data division masks for training validation and test sets
- Number of epochs (`num_epochs`) and the best epoch (`best_epoch`).
- A list of training state names (`states`).
- Fields for each state name recording its value throughout training
- Performances of the best network (`best_perf`, `best_vperf`, `best_tperf`)

**Algorithms**

`train` calls the function indicated by `net.trainFcn`, using the training parameter values indicated by `net.trainParam`.

Typically one epoch of training is defined as a single presentation of all input vectors to the network. The network is then updated according to the results of all those presentations.

Training occurs until a maximum number of epochs occurs, the performance goal is met, or any other stopping condition of the function `net.trainFcn` occurs.

Some training functions depart from this norm by presenting only one input vector (or sequence) each epoch. An input vector (or sequence) is chosen randomly for each epoch from concurrent input vectors (or sequences). `competlayer` returns networks that use `trainru`, a training function that does this.

**See Also**

`adapt` | `init` | `revert` | `sim`

**Introduced before R2006a**

## trainb

Batch training with weight and bias learning rules

### Syntax

```
net.trainFcn = 'trainb'
[net,tr] = train(net,...)
```

### Description

`trainb` is not called directly. Instead it is called by `train` for networks whose `net.trainFcn` property is set to `'trainb'`, thus:

`net.trainFcn = 'trainb'` sets the network `trainFcn` property.

`[net,tr] = train(net,...)` trains the network with `trainb`.

`trainb` trains a network with weight and bias learning rules with batch updates. The weights and biases are updated at the end of an entire pass through the input data.

Training occurs according to `trainb`'s training parameters, shown here with their default values:

<code>net.trainParam.epochs</code>	1000	Maximum number of epochs to train
<code>net.trainParam.goal</code>	0	Performance goal
<code>net.trainParam.max_fail</code>	6	Maximum validation failures
<code>net.trainParam.min_grad</code>	1e-6	Minimum performance gradient
<code>net.trainParam.show</code>	25	Epochs between displays (NaN for no displays)
<code>net.trainParam.showCommandLine</code>	false	Generate command-line output
<code>net.trainParam.showWindow</code>	true	Show training GUI
<code>net.trainParam.time</code>	inf	Maximum time to train in seconds

### Network Use

You can create a standard network that uses `trainb` by calling `linearlayer`.

To prepare a custom network to be trained with `trainb`,

- 1 Set `net.trainFcn` to `'trainb'`. This sets `net.trainParam` to `trainb`'s default parameters.
- 2 Set each `net.inputWeights{i,j}.learnFcn` to a learning function. Set each `net.layerWeights{i,j}.learnFcn` to a learning function. Set each `net.biases{i}.learnFcn` to a learning function. (Weight and bias learning parameters are automatically set to default values for the given learning function.)

To train the network,

- 1 Set `net.trainParam` properties to desired values.

- 2 Set weight and bias learning parameters to desired values.
- 3 Call `train`.

### Algorithms

Each weight and bias is updated according to its learning function after each epoch (one pass through the entire set of input vectors).

Training stops when any of these conditions is met:

- The maximum number of `epochs` (repetitions) is reached.
- Performance is minimized to the `goal`.
- The maximum amount of `time` is exceeded.
- Validation performance has increased more than `max_fail` times since the last time it decreased (when using validation).

### See Also

`linearlayer` | `train`

**Introduced before R2006a**

# trainbfg

BFGS quasi-Newton backpropagation

## Syntax

```
net.trainFcn = 'trainbfg'
[net,tr] = train(net,...)
```

## Description

`trainbfg` is a network training function that updates weight and bias values according to the BFGS quasi-Newton method.

`net.trainFcn = 'trainbfg'` sets the network `trainFcn` property.

`[net,tr] = train(net,...)` trains the network with `trainbfg`.

Training occurs according to `trainbfg` training parameters, shown here with their default values:

<code>net.trainParam.epochs</code>	1000	Maximum number of epochs to train
<code>net.trainParam.showWindow</code>	true	Show training window
<code>net.trainParam.show</code>	25	Epochs between displays (NaN for no displays)
<code>net.trainParam.showCommandLine</code>	false	Generate command-line output
<code>net.trainParam.goal</code>	0	Performance goal
<code>net.trainParam.time</code>	inf	Maximum time to train in seconds
<code>net.trainParam.min_grad</code>	1e-6	Minimum performance gradient
<code>net.trainParam.max_fail</code>	6	Maximum validation failures
<code>net.trainParam.searchFcn</code>	'srchbac'	Name of line search routine to use

Parameters related to line search methods (not all used for all methods):

<code>net.trainParam.sca1_tol</code>	20	Divide into <code>delta</code> to determine tolerance for linear search.
<code>net.trainParam.alpha</code>	0.001	Scale factor that determines sufficient reduction in <code>perf</code>
<code>net.trainParam.beta</code>	0.1	Scale factor that determines sufficiently large step size
<code>net.trainParam.delta</code>	0.01	Initial step size in interval location step
<code>net.trainParam.gama</code>	0.1	Parameter to avoid small reductions in performance, usually set to 0.1 (see <code>srch_cha</code> )
<code>net.trainParam.low_lim</code>	0.1	Lower limit on change in step size
<code>net.trainParam.up_lim</code>	0.5	Upper limit on change in step size
<code>net.trainParam.maxstep</code>	100	Maximum step length
<code>net.trainParam.minstep</code>	1.0e-6	Minimum step length

<code>net.trainParam.bmax</code>	26	Maximum step size
<code>net.trainParam.batch_frag</code>	0	In case of multiple batches, they are considered independent. Any nonzero value implies a fragmented batch, so the final layer's conditions of a previous trained epoch are used as initial conditions for the next epoch.

## Network Use

You can create a standard network that uses `trainbfg` with `feedforwardnet` or `cascadeforwardnet`. To prepare a custom network to be trained with `trainbfg`:

- 1 Set `NET.trainFcn` to `'trainbfg'`. This sets `NET.trainParam` to `trainbfg`'s default parameters.
- 2 Set `NET.trainParam` properties to desired values.

In either case, calling `train` with the resulting network trains the network with `trainbfg`.

## Examples

### Train Neural Network Using `trainbfg` Train Function

This example shows how to train a neural network using the `trainbfg` train function.

Here a neural network is trained to predict body fat percentages.

```
[x, t] = bodyfat_dataset;
net = feedforwardnet(10, 'trainbfg');
net = train(net, x, t);
y = net(x);
```

## More About

### BFGS Quasi-Newton Backpropagation

Newton's method is an alternative to the conjugate gradient methods for fast optimization. The basic step of Newton's method is

$$\mathbf{x}_{k+1} = \mathbf{x}_k - \mathbf{A}_k^{-1} \mathbf{g}_k$$

where  $\mathbf{A}_k^{-1}$  is the Hessian matrix (second derivatives) of the performance index at the current values of the weights and biases. Newton's method often converges faster than conjugate gradient methods. Unfortunately, it is complex and expensive to compute the Hessian matrix for feedforward neural networks. There is a class of algorithms that is based on Newton's method, but which does not require calculation of second derivatives. These are called quasi-Newton (or secant) methods. They update an approximate Hessian matrix at each iteration of the algorithm. The update is computed as a function of the gradient. The quasi-Newton method that has been most successful in published studies is the Broyden, Fletcher, Goldfarb, and Shanno (BFGS) update. This algorithm is implemented in the `trainbfg` routine.



The BFGS algorithm is described in [DeSc83]. This algorithm requires more computation in each iteration and more storage than the conjugate gradient methods, although it generally converges in fewer iterations. The approximate Hessian must be stored, and its dimension is  $n \times n$ , where  $n$  is equal to the number of weights and biases in the network. For very large networks it might be better to use Rprop or one of the conjugate gradient algorithms. For smaller networks, however, `trainbfg` can be an efficient training function.

## Algorithms

`trainbfg` can train any network as long as its weight, net input, and transfer functions have derivative functions.

Backpropagation is used to calculate derivatives of performance `perf` with respect to the weight and bias variables  $X$ . Each variable is adjusted according to the following:

$$X = X + a*dX;$$

where  $dX$  is the search direction. The parameter  $a$  is selected to minimize the performance along the search direction. The line search function `searchFcn` is used to locate the minimum point. The first search direction is the negative of the gradient of performance. In succeeding iterations the search direction is computed according to the following formula:

$$dX = -H \backslash gX;$$

where  $gX$  is the gradient and  $H$  is an approximate Hessian matrix. See page 119 of Gill, Murray, and Wright (*Practical Optimization*, 1981) for a more detailed discussion of the BFGS quasi-Newton method.

Training stops when any of these conditions occurs:

- The maximum number of `epochs` (repetitions) is reached.
- The maximum amount of `time` is exceeded.
- Performance is minimized to the `goal`.
- The performance gradient falls below `min_grad`.
- Validation performance has increased more than `max_fail` times since the last time it decreased (when using validation).

## References

Gill, Murray, & Wright, *Practical Optimization*, 1981

## See Also

`cascadeforwardnet` | `feedforwardnet` | `traincgb` | `traincgf` | `traincgp` | `traingda` | `traingdm` | `traingdx` | `trainlm` | `trainoss` | `trainrp` | `trainscg`

**Introduced before R2006a**

## trainbfgc

BFGS quasi-Newton backpropagation for use with NN model reference adaptive controller

### Syntax

```
[net,TR,Y,E,Pf,Af,flag_stop] = trainbfgc(net,P,T,Pi,Ai,epochs,TS,Q)
info = trainbfgc(code)
```

### Description

`trainbfgc` is a network training function that updates weight and bias values according to the BFGS quasi-Newton method. This function is called from `nnmodref`, a GUI for the model reference adaptive control Simulink block.

`[net,TR,Y,E,Pf,Af,flag_stop] = trainbfgc(net,P,T,Pi,Ai,epochs,TS,Q)` takes these inputs,

net	Neural network
P	Delayed input vectors
T	Layer target vectors
Pi	Initial input delay conditions
Ai	Initial layer delay conditions
epochs	Number of iterations for training
TS	Time steps
Q	Batch size

and returns

net	Trained network
TR	Training record of various values over each epoch:
	TR.epoch Epoch number
	TR.perf Training performance
	TR.vperf Validation performance
	TR.tperf Test performance
Y	Network output for last epoch
E	Layer errors for last epoch
Pf	Final input delay conditions
Af	Collective layer outputs for last epoch
flag_stop	Indicates if the user stopped the training

Training occurs according to `trainbfgc`'s training parameters, shown here with their default values:

net.trainParam.epochs	100	Maximum number of epochs to train
net.trainParam.show	25	Epochs between displays (NaN for no displays)
net.trainParam.goal	0	Performance goal
net.trainParam.time	inf	Maximum time to train in seconds
net.trainParam.min_grad	1e-6	Minimum performance gradient
net.trainParam.max_fail	5	Maximum validation failures
net.trainParam.searchFcn	'srchbax'	Name of line search routine to use

Parameters related to line search methods (not all used for all methods):

net.trainParam.scal_tol	20	Divide into delta to determine tolerance for linear search.
net.trainParam.alpha	0.001	Scale factor that determines sufficient reduction in perf
net.trainParam.beta	0.1	Scale factor that determines sufficiently large step size
net.trainParam.delta	0.01	Initial step size in interval location step
net.trainParam.gama	0.1	Parameter to avoid small reductions in performance, usually set to 0.1 (see srch_cha)
net.trainParam.low_lim	0.1	Lower limit on change in step size
net.trainParam.up_lim	0.5	Upper limit on change in step size
net.trainParam.maxstep	100	Maximum step length
net.trainParam.minstep	1.0e-6	Minimum step length
net.trainParam.bmax	26	Maximum step size

info = trainbfgc(code) returns useful information for each code character vector:

'pnames'	Names of training parameters
'pdefaults'	Default training parameters

## Algorithms

trainbfgc can train any network as long as its weight, net input, and transfer functions have derivative functions. Backpropagation is used to calculate derivatives of performance perf with respect to the weight and bias variables X. Each variable is adjusted according to the following:

$$X = X + a*dX;$$

where dX is the search direction. The parameter a is selected to minimize the performance along the search direction. The line search function searchFcn is used to locate the minimum point. The first search direction is the negative of the gradient of performance. In succeeding iterations the search direction is computed according to the following formula:

$$dX = -H \setminus gX;$$

where gX is the gradient and H is an approximate Hessian matrix. See page 119 of Gill, Murray, and Wright (*Practical Optimization*, 1981) for a more detailed discussion of the BFGS quasi-Newton method.

Training stops when any of these conditions occurs:

- The maximum number of `epochs` (repetitions) is reached.
- The maximum amount of `time` is exceeded.
- Performance is minimized to the `goal`.
- The performance gradient falls below `min_grad`.
- Precision problems have occurred in the matrix inversion.

### References

Gill, Murray, and Wright, *Practical Optimization*, 1981

**Introduced in R2006a**

# trainbr

Bayesian regularization backpropagation

## Syntax

```
net.trainFcn = 'trainbr'
[net,tr] = train(net,...)
```

## Description

`trainbr` is a network training function that updates the weight and bias values according to Levenberg-Marquardt optimization. It minimizes a combination of squared errors and weights, and then determines the correct combination so as to produce a network that generalizes well. The process is called Bayesian regularization.

`net.trainFcn = 'trainbr'` sets the network `trainFcn` property.

`[net,tr] = train(net,...)` trains the network with `trainbr`.

Training occurs according to `trainbr` training parameters, shown here with their default values:

<code>net.trainParam.epochs</code>	1000	Maximum number of epochs to train
<code>net.trainParam.goal</code>	0	Performance goal
<code>net.trainParam.mu</code>	0.005	Marquardt adjustment parameter
<code>net.trainParam.mu_dec</code>	0.1	Decrease factor for mu
<code>net.trainParam.mu_inc</code>	10	Increase factor for mu
<code>net.trainParam.mu_max</code>	1e10	Maximum value for mu
<code>net.trainParam.max_fail</code>	inf	Maximum validation failures
<code>net.trainParam.min_grad</code>	1e-7	Minimum performance gradient
<code>net.trainParam.show</code>	25	Epochs between displays (NaN for no displays)
<code>net.trainParam.showCommandLine</code>	false	Generate command-line output
<code>net.trainParam.showWindow</code>	true	Show training GUI
<code>net.trainParam.time</code>	inf	Maximum time to train in seconds

Validation stops are disabled by default (`max_fail = inf`) so that training can continue until an optimal combination of errors and weights is found. However, some weight/bias minimization can still be achieved with shorter training times if validation is enabled by setting `max_fail` to 6 or some other strictly positive value.

## Network Use

You can create a standard network that uses `trainbr` with `feedforwardnet` or `cascadeforwardnet`. To prepare a custom network to be trained with `trainbr`,

- 1 Set `NET.trainFcn` to `'trainbr'`. This sets `NET.trainParam` to `trainbr`'s default parameters.
- 2 Set `NET.trainParam` properties to desired values.

In either case, calling `train` with the resulting network trains the network with `trainbr`. See `feedforwardnet` and `cascaforwardnet` for examples.

## Examples

Here is a problem consisting of inputs `p` and targets `t` to be solved with a network. It involves fitting a noisy sine wave.

```
p = [-1:.05:1];  
t = sin(2*pi*p)+0.1*randn(size(p));
```

A feed-forward network is created with a hidden layer of 2 neurons.

```
net = feedforwardnet(2,'trainbr');
```

Here the network is trained and tested.

```
net = train(net,p,t);  
a = net(p)
```

## Limitations

This function uses the Jacobian for calculations, which assumes that performance is a mean or sum of squared errors. Therefore networks trained with this function must use either the `mse` or `sse` performance function.

## Algorithms

`trainbr` can train any network as long as its weight, net input, and transfer functions have derivative functions.

Bayesian regularization minimizes a linear combination of squared errors and weights. It also modifies the linear combination so that at the end of training the resulting network has good generalization qualities. See MacKay (*Neural Computation*, Vol. 4, No. 3, 1992, pp. 415 to 447) and Foresee and Hagan (*Proceedings of the International Joint Conference on Neural Networks*, June, 1997) for more detailed discussions of Bayesian regularization.

This Bayesian regularization takes place within the Levenberg-Marquardt algorithm. Backpropagation is used to calculate the Jacobian  $jX$  of performance `perf` with respect to the weight and bias variables `X`. Each variable is adjusted according to Levenberg-Marquardt,

```
jj = jX * jX  
je = jX * E  
dX = -(jj+I*mu) \ je
```

where `E` is all errors and `I` is the identity matrix.

The adaptive value `mu` is increased by `mu_inc` until the change shown above results in a reduced performance value. The change is then made to the network, and `mu` is decreased by `mu_dec`.

Training stops when any of these conditions occurs:

- The maximum number of `epochs` (repetitions) is reached.
- The maximum amount of `time` is exceeded.
- Performance is minimized to the `goal`.
- The performance gradient falls below `min_grad`.
- `mu` exceeds `mu_max`.

## References

- [1] MacKay, David J. C. "Bayesian interpolation." *Neural computation*. Vol. 4, No. 3, 1992, pp. 415-447.
- [2] Foresee, F. Dan, and Martin T. Hagan. "Gauss-Newton approximation to Bayesian learning." *Proceedings of the International Joint Conference on Neural Networks*, June, 1997.

## See Also

`cascadeforwardnet` | `feedforwardnet` | `trainbfg` | `traincgb` | `traincgf` | `traincgp` | `traingda` | `traingdm` | `traingdx` | `trainlm` | `trainrp` | `trainscg`

**Introduced before R2006a**

## trainbu

Batch unsupervised weight/bias training

### Syntax

```
net.trainFcn = 'trainbu'
[net,tr] = train(net,...)
```

### Description

`trainbu` trains a network with weight and bias learning rules with batch updates. Weights and biases updates occur at the end of an entire pass through the input data.

`trainbu` is not called directly. Instead the `train` function calls it for networks whose `NET.trainFcn` property is set to `'trainbu'`, thus:

`net.trainFcn = 'trainbu'` sets the network `trainFcn` property.

`[net,tr] = train(net,...)` trains the network with `trainbu`.

Training occurs according to `trainbu` training parameters, shown here with the following default values:

<code>net.trainParam.epochs</code>	1000	Maximum number of epochs to train
<code>net.trainParam.show</code>	25	Epochs between displays (NaN for no displays)
<code>net.trainParam.showCommandLine</code>	false	Generate command-line output
<code>net.trainParam.showWindow</code>	true	Show training GUI
<code>net.trainParam.time</code>	inf	Maximum time to train in seconds

Validation and test vectors have no impact on training for this function, but act as independent measures of network generalization.

### Network Use

You can create a standard network that uses `trainbu` by calling `selforgmap`. To prepare a custom network to be trained with `trainbu`:

- 1 Set `NET.trainFcn` to `'trainbu'`. (This option sets `NET.trainParam` to `trainbu` default parameters.)
- 2 Set each `NET.inputWeights{i,j}.learnFcn` to a learning function.
- 3 Set each `NET.layerWeights{i,j}.learnFcn` to a learning function.
- 4 Set each `NET.biases{i}.learnFcn` to a learning function. (Weight and bias learning parameters are automatically set to default values for the given learning function.)

To train the network:

- 1 Set `NET.trainParam` properties to desired values.



- 2 Set weight and bias learning parameters to desired values.
- 3 Call `train`.

See `selforgmap` for training examples.

## Algorithms

Each weight and bias updates according to its learning function after each epoch (one pass through the entire set of input vectors).

Training stops when any of these conditions is met:

- The maximum number of `epochs` (repetitions) is reached.
- Performance is minimized to the `goal`.
- The maximum amount of `time` is exceeded.
- Validation performance has increased more than `max_fail` times since the last time it decreased (when using validation).

## See Also

`train` | `trainb`

**Introduced in R2010b**

## trainc

Cyclical order weight/bias training

### Syntax

```
net.trainFcn = 'trainc'
[net,tr] = train(net,...)
```

### Description

`trainc` is not called directly. Instead it is called by `train` for networks whose `net.trainFcn` property is set to 'trainc', thus:

`net.trainFcn = 'trainc'` sets the network `trainFcn` property.

`[net,tr] = train(net,...)` trains the network with `trainc`.

`trainc` trains a network with weight and bias learning rules with incremental updates after each presentation of an input. Inputs are presented in cyclic order.

Training occurs according to `trainc` training parameters, shown here with their default values:

<code>net.trainParam.epochs</code>	1000	Maximum number of epochs to train
<code>net.trainParam.goal</code>	0	Performance goal
<code>net.trainParam.max_fail</code>	6	Maximum validation failures
<code>net.trainParam.show</code>	25	Epochs between displays (NaN for no displays)
<code>net.trainParam.showCommandLine</code>	false	Generate command-line output
<code>net.trainParam.showWindow</code>	true	Show training GUI
<code>net.trainParam.time</code>	inf	Maximum time to train in seconds

### Network Use

You can create a standard network that uses `trainc` by calling `competlayer`. To prepare a custom network to be trained with `trainc`,

- 1 Set `net.trainFcn` to 'trainc'. This sets `net.trainParam` to `trainc`'s default parameters.
- 2 Set each `net.inputWeights{i,j}.learnFcn` to a learning function. Set each `net.layerWeights{i,j}.learnFcn` to a learning function. Set each `net.biases{i}.learnFcn` to a learning function. (Weight and bias learning parameters are automatically set to default values for the given learning function.)

To train the network,

- 1 Set `net.trainParam` properties to desired values.
- 2 Set weight and bias learning parameters to desired values.
- 3 Call `train`.

See `perceptron` for training examples.

## Algorithms

For each epoch, each vector (or sequence) is presented in order to the network, with the weight and bias values updated accordingly after each individual presentation.

Training stops when any of these conditions is met:

- The maximum number of epochs (repetitions) is reached.
- Performance is minimized to the goal.
- The maximum amount of time is exceeded.

## See Also

`competlayer` | `train`

**Introduced before R2006a**

## traincgb

Conjugate gradient backpropagation with Powell-Beale restarts

### Syntax

```
net.trainFcn = 'traincgb'
[net,tr] = train(net,...)
```

### Description

`traincgb` is a network training function that updates weight and bias values according to the conjugate gradient backpropagation with Powell-Beale restarts.

`net.trainFcn = 'traincgb'` sets the network `trainFcn` property.

`[net,tr] = train(net,...)` trains the network with `traincgb`.

Training occurs according to `traincgb` training parameters, shown here with their default values:

<code>net.trainParam.epochs</code>	1000	Maximum number of epochs to train
<code>net.trainParam.show</code>	25	Epochs between displays (NaN for no displays)
<code>net.trainParam.showCommandLine</code>	false	Generate command-line output
<code>net.trainParam.showWindow</code>	true	Show training GUI
<code>net.trainParam.goal</code>	0	Performance goal
<code>net.trainParam.time</code>	inf	Maximum time to train in seconds
<code>net.trainParam.min_grad</code>	1e-10	Minimum performance gradient
<code>net.trainParam.max_fail</code>	6	Maximum validation failures
<code>net.trainParam.searchFcn</code>	'srchcha'	Name of line search routine to use

Parameters related to line search methods (not all used for all methods):

<code>net.trainParam.scal_tol</code>	20	Divide into <code>delta</code> to determine tolerance for linear search.
<code>net.trainParam.alpha</code>	0.001	Scale factor that determines sufficient reduction in <code>perf</code>
<code>net.trainParam.beta</code>	0.1	Scale factor that determines sufficiently large step size
<code>net.trainParam.delta</code>	0.01	Initial step size in interval location step
<code>net.trainParam.gama</code>	0.1	Parameter to avoid small reductions in performance, usually set to 0.1 (see <code>srch_cha</code> )
<code>net.trainParam.low_lim</code>	0.1	Lower limit on change in step size
<code>net.trainParam.up_lim</code>	0.5	Upper limit on change in step size
<code>net.trainParam.maxstep</code>	100	Maximum step length
<code>net.trainParam.minstep</code>	1.0e-6	Minimum step length

<code>net.trainParam.bmax</code>	26	Maximum step size
----------------------------------	----	-------------------

## Network Use

You can create a standard network that uses `traincgb` with `feedforwardnet` or `cascadeforwardnet`.

To prepare a custom network to be trained with `traincgb`,

- 1 Set `net.trainFcn` to `'traincgb'`. This sets `net.trainParam` to `traincgb`'s default parameters.
- 2 Set `net.trainParam` properties to desired values.

In either case, calling `train` with the resulting network trains the network with `traincgb`.

## Examples

### Train Neural Network Using `traincgb` Train Function

This example shows how to train a neural network using the `traincgb` train function.

Here a neural network is trained to predict body fat percentages.

```
[x, t] = bodyfat_dataset;
net = feedforwardnet(10, 'traincgb');
net = train(net, x, t);
y = net(x);
```

## More About

### Powell-Beale Algorithm

For all conjugate gradient algorithms, the search direction is periodically reset to the negative of the gradient. The standard reset point occurs when the number of iterations is equal to the number of network parameters (weights and biases), but there are other reset methods that can improve the efficiency of training. One such reset method was proposed by Powell [Powe77], based on an earlier version proposed by Beale [Beal72]. This technique restarts if there is very little orthogonality left between the current gradient and the previous gradient. This is tested with the following inequality:

$$|\mathbf{g}_{k-1}^T \mathbf{g}_k| \geq 0.2 \|\mathbf{g}_k\|^2$$

If this condition is satisfied, the search direction is reset to the negative of the gradient.

The `traincgb` routine has somewhat better performance than `traincgp` for some problems, although performance on any given problem is difficult to predict. The storage requirements for the Powell-Beale algorithm (six vectors) are slightly larger than for Polak-Ribière (four vectors).

## Algorithms

`traincgb` can train any network as long as its weight, net input, and transfer functions have derivative functions.

Backpropagation is used to calculate derivatives of performance `perf` with respect to the weight and bias variables `X`. Each variable is adjusted according to the following:

$$X = X + a*dX;$$

where `dX` is the search direction. The parameter `a` is selected to minimize the performance along the search direction. The line search function `searchFcn` is used to locate the minimum point. The first search direction is the negative of the gradient of performance. In succeeding iterations the search direction is computed from the new gradient and the previous search direction according to the formula

$$dX = -gX + dX\_old*Z;$$

where `gX` is the gradient. The parameter `Z` can be computed in several different ways. The Powell-Beale variation of conjugate gradient is distinguished by two features. First, the algorithm uses a test to determine when to reset the search direction to the negative of the gradient. Second, the search direction is computed from the negative gradient, the previous search direction, and the last search direction before the previous reset. See Powell, *Mathematical Programming*, Vol. 12, 1977, pp. 241 to 254, for a more detailed discussion of the algorithm.

Training stops when any of these conditions occurs:

- The maximum number of epochs (repetitions) is reached.
- The maximum amount of `time` is exceeded.
- Performance is minimized to the `goal`.
- The performance gradient falls below `min_grad`.
- Validation performance has increased more than `max_fail` times since the last time it decreased (when using validation).

## References

Powell, M.J.D., "Restart procedures for the conjugate gradient method," *Mathematical Programming*, Vol. 12, 1977, pp. 241-254

## See Also

`trainbfg` | `traincgf` | `traincgp` | `traingda` | `traingdm` | `traingdx` | `trainlm` | `trainoss` | `trainscg`

**Introduced before R2006a**

# traincgf

Conjugate gradient backpropagation with Fletcher-Reeves updates

## Syntax

```
net.trainFcn = 'traincgf'
[net,tr] = train(net,...)
```

## Description

`traincgf` is a network training function that updates weight and bias values according to conjugate gradient backpropagation with Fletcher-Reeves updates.

`net.trainFcn = 'traincgf'` sets the network `trainFcn` property.

`[net,tr] = train(net,...)` trains the network with `traincgf`.

Training occurs according to `traincgf` training parameters, shown here with their default values:

<code>net.trainParam.epochs</code>	1000	Maximum number of epochs to train
<code>net.trainParam.show</code>	25	Epochs between displays (NaN for no displays)
<code>net.trainParam.showCommandLine</code>	false	Generate command-line output
<code>net.trainParam.showWindow</code>	true	Show training GUI
<code>net.trainParam.goal</code>	0	Performance goal
<code>net.trainParam.time</code>	inf	Maximum time to train in seconds
<code>net.trainParam.min_grad</code>	1e-10	Minimum performance gradient
<code>net.trainParam.max_fail</code>	6	Maximum validation failures
<code>net.trainParam.searchFcn</code>	'srchcha'	Name of line search routine to use

Parameters related to line search methods (not all used for all methods):

<code>net.trainParam.sca1_tol</code>	20	Divide into <code>delta</code> to determine tolerance for linear search.
<code>net.trainParam.alpha</code>	0.001	Scale factor that determines sufficient reduction in <code>perf</code>
<code>net.trainParam.beta</code>	0.1	Scale factor that determines sufficiently large step size
<code>net.trainParam.delta</code>	0.01	Initial step size in interval location step
<code>net.trainParam.gama</code>	0.1	Parameter to avoid small reductions in performance, usually set to 0.1 (see <code>srch_cha</code> )
<code>net.trainParam.low_lim</code>	0.1	Lower limit on change in step size
<code>net.trainParam.up_lim</code>	0.5	Upper limit on change in step size
<code>net.trainParam.maxstep</code>	100	Maximum step length
<code>net.trainParam.minstep</code>	1.0e-6	Minimum step length

<code>net.trainParam.bmax</code>	26	Maximum step size
----------------------------------	----	-------------------

## Network Use

You can create a standard network that uses `traincgf` with `feedforwardnet` or `cascadeforwardnet`.

To prepare a custom network to be trained with `traincgf`,

- 1 Set `net.trainFcn` to `'traincgf'`. This sets `net.trainParam` to `traincgf`'s default parameters.
- 2 Set `net.trainParam` properties to desired values.

In either case, calling `train` with the resulting network trains the network with `traincgf`.

## Examples

### Train Neural Network Using `traincgf` Train Function

This example shows how to train a neural network using the `traincgf` train function.

Here a neural network is trained to predict body fat percentages.

```
[x, t] = bodyfat_dataset;
net = feedforwardnet(10, 'traincgf');
net = train(net, x, t);
y = net(x);
```

## More About

### Conjugate Gradient Algorithms

All the conjugate gradient algorithms start out by searching in the steepest descent direction (negative of the gradient) on the first iteration.

$$\mathbf{p}_0 = -\mathbf{g}_0$$

A line search is then performed to determine the optimal distance to move along the current search direction:

$$\mathbf{x}_{k+1} = \mathbf{x}_k + \alpha_k \mathbf{p}_k$$

Then the next search direction is determined so that it is conjugate to previous search directions. The general procedure for determining the new search direction is to combine the new steepest descent direction with the previous search direction:

$$\mathbf{p}_k = -\mathbf{g}_k + \beta_k \mathbf{p}_{k-1}$$

The various versions of the conjugate gradient algorithm are distinguished by the manner in which the constant  $\beta_k$  is computed. For the Fletcher-Reeves update the procedure is



$$\beta_k = \frac{\mathbf{g}_k^T \mathbf{g}_k}{\mathbf{g}_{k-1}^T \mathbf{g}_{k-1}}$$

This is the ratio of the norm squared of the current gradient to the norm squared of the previous gradient.

See [FlRe64] or [HDB96] for a discussion of the Fletcher-Reeves conjugate gradient algorithm.

The conjugate gradient algorithms are usually much faster than variable learning rate backpropagation, and are sometimes faster than `trainrp`, although the results vary from one problem to another. The conjugate gradient algorithms require only a little more storage than the simpler algorithms. Therefore, these algorithms are good for networks with a large number of weights.

Try the *Neural Network Design* demonstration `nnd12cg` [HDB96] for an illustration of the performance of a conjugate gradient algorithm.

## Algorithms

`traincgf` can train any network as long as its weight, net input, and transfer functions have derivative functions.

Backpropagation is used to calculate derivatives of performance `perf` with respect to the weight and bias variables `X`. Each variable is adjusted according to the following:

$$X = X + a * dX;$$

where `dX` is the search direction. The parameter `a` is selected to minimize the performance along the search direction. The line search function `searchFcn` is used to locate the minimum point. The first search direction is the negative of the gradient of performance. In succeeding iterations the search direction is computed from the new gradient and the previous search direction, according to the formula

$$dX = -gX + dX_{old} * Z;$$

where `gX` is the gradient. The parameter `Z` can be computed in several different ways. For the Fletcher-Reeves variation of conjugate gradient it is computed according to

$$Z = \text{normnew\_sqr} / \text{norm\_sqr};$$

where `norm_sqr` is the norm square of the previous gradient and `normnew_sqr` is the norm square of the current gradient. See page 78 of Scales (*Introduction to Non-Linear Optimization*) for a more detailed discussion of the algorithm.

Training stops when any of these conditions occurs:

- The maximum number of `epochs` (repetitions) is reached.
- The maximum amount of `time` is exceeded.
- Performance is minimized to the `goal`.
- The performance gradient falls below `min_grad`.
- Validation performance has increased more than `max_fail` times since the last time it decreased (when using validation).

## References

Scales, L.E., *Introduction to Non-Linear Optimization*, New York, Springer-Verlag, 1985

## See Also

`trainbfg` | `traincgb` | `traincgp` | `traingda` | `traingdm` | `traingdx` | `trainlm` | `trainoss` | `trainscg`

**Introduced before R2006a**

# traincgp

Conjugate gradient backpropagation with Polak-Ribière updates

## Syntax

```
net.trainFcn = 'traincgp'
[net,tr] = train(net,...)
```

## Description

`traincgp` is a network training function that updates weight and bias values according to conjugate gradient backpropagation with Polak-Ribière updates.

`net.trainFcn = 'traincgp'` sets the network `trainFcn` property.

`[net,tr] = train(net,...)` trains the network with `traincgp`.

Training occurs according to `traincgp` training parameters, shown here with their default values:

<code>net.trainParam.epochs</code>	1000	Maximum number of epochs to train
<code>net.trainParam.show</code>	25	Epochs between displays (NaN for no displays)
<code>net.trainParam.showCommandLine</code>	false	Generate command-line output
<code>net.trainParam.showWindow</code>	true	Show training GUI
<code>net.trainParam.goal</code>	0	Performance goal
<code>net.trainParam.time</code>	inf	Maximum time to train in seconds
<code>net.trainParam.min_grad</code>	1e-10	Minimum performance gradient
<code>net.trainParam.max_fail</code>	6	Maximum validation failures
<code>net.trainParam.searchFcn</code>	'srchcha'	Name of line search routine to use

Parameters related to line search methods (not all used for all methods):

<code>net.trainParam.sca1_tol</code>	20	Divide into <code>delta</code> to determine tolerance for linear search.
<code>net.trainParam.alpha</code>	0.001	Scale factor that determines sufficient reduction in <code>perf</code>
<code>net.trainParam.beta</code>	0.1	Scale factor that determines sufficiently large step size
<code>net.trainParam.delta</code>	0.01	Initial step size in interval location step
<code>net.trainParam.gama</code>	0.1	Parameter to avoid small reductions in performance, usually set to 0.1 (see <code>srch_cha</code> )
<code>net.trainParam.low_lim</code>	0.1	Lower limit on change in step size
<code>net.trainParam.up_lim</code>	0.5	Upper limit on change in step size
<code>net.trainParam.maxstep</code>	100	Maximum step length
<code>net.trainParam.minstep</code>	1.0e-6	Minimum step length

<code>net.trainParam.bmax</code>	26	Maximum step size
----------------------------------	----	-------------------

## Network Use

You can create a standard network that uses `traincgp` with `feedforwardnet` or `cascadeforwardnet`. To prepare a custom network to be trained with `traincgp`,

- 1 Set `net.trainFcn` to `'traincgp'`. This sets `net.trainParam` to `traincgp`'s default parameters.
- 2 Set `net.trainParam` properties to desired values.

In either case, calling `train` with the resulting network trains the network with `traincgp`.

## Examples

### Train Neural Network Using `traincgp` Train Function

This example shows how to train a neural network using the `traincgp` train function.

Here a neural network is trained to predict body fat percentages.

```
[x, t] = bodyfat_dataset;
net = feedforwardnet(10, 'traincgp');
net = train(net, x, t);
y = net(x);
```

## More About

### Conjugate Gradient Backpropagation with Polak-Ribière Updates

Another version of the conjugate gradient algorithm was proposed by Polak and Ribière. As with the Fletcher-Reeves algorithm, `traincgf`, the search direction at each iteration is determined by

$$\mathbf{p}_k = -\mathbf{g}_k + \beta_k \mathbf{p}_{k-1}$$

For the Polak-Ribière update, the constant  $\beta_k$  is computed by

$$\beta_k = \frac{\Delta \mathbf{g}_{k-1}^T \mathbf{g}_k}{\mathbf{g}_{k-1}^T \mathbf{g}_{k-1}}$$

This is the inner product of the previous change in the gradient with the current gradient divided by the norm squared of the previous gradient. See [FlRe64] or [HDB96] for a discussion of the Polak-Ribière conjugate gradient algorithm.

The `traincgp` routine has performance similar to `traincgf`. It is difficult to predict which algorithm will perform best on a given problem. The storage requirements for Polak-Ribière (four vectors) are slightly larger than for Fletcher-Reeves (three vectors).

## Algorithms

`traincgp` can train any network as long as its weight, net input, and transfer functions have derivative functions.

Backpropagation is used to calculate derivatives of performance `perf` with respect to the weight and bias variables `X`. Each variable is adjusted according to the following:

$$X = X + a*dX;$$

where `dX` is the search direction. The parameter `a` is selected to minimize the performance along the search direction. The line search function `searchFcn` is used to locate the minimum point. The first search direction is the negative of the gradient of performance. In succeeding iterations the search direction is computed from the new gradient and the previous search direction according to the formula

$$dX = -gX + dX\_old*Z;$$

where `gX` is the gradient. The parameter `Z` can be computed in several different ways. For the Polak-Ribière variation of conjugate gradient, it is computed according to

$$Z = ((gX - gX\_old)'*gX)/norm\_sqr;$$

where `norm_sqr` is the norm square of the previous gradient, and `gX_old` is the gradient on the previous iteration. See page 78 of *Scales (Introduction to Non-Linear Optimization, 1985)* for a more detailed discussion of the algorithm.

Training stops when any of these conditions occurs:

- The maximum number of epochs (repetitions) is reached.
- The maximum amount of `time` is exceeded.
- Performance is minimized to the `goal`.
- The performance gradient falls below `min_grad`.
- Validation performance has increased more than `max_fail` times since the last time it decreased (when using validation).

## References

Scales, L.E., *Introduction to Non-Linear Optimization*, New York, Springer-Verlag, 1985

## See Also

`trainbfg` | `traincgb` | `traincgf` | `traingda` | `traingdm` | `traingdx` | `trainlm` | `trainoss` | `trainrp` | `trainscg`

**Introduced before R2006a**

## traingd

Gradient descent backpropagation

### Syntax

```
net.trainFcn = 'traingd'
[net,tr] = train(net,...)
```

### Description

`traingd` is a network training function that updates weight and bias values according to gradient descent.

`net.trainFcn = 'traingd'` sets the network `trainFcn` property.

`[net,tr] = train(net,...)` trains the network with `traingd`.

Training occurs according to `traingd` training parameters, shown here with their default values:

<code>net.trainParam.epochs</code>	1000	Maximum number of epochs to train
<code>net.trainParam.goal</code>	0	Performance goal
<code>net.trainParam.showCommandLine</code>	false	Generate command-line output
<code>net.trainParam.showWindow</code>	true	Show training GUI
<code>net.trainParam.lr</code>	0.01	Learning rate
<code>net.trainParam.max_fail</code>	6	Maximum validation failures
<code>net.trainParam.min_grad</code>	1e-5	Minimum performance gradient
<code>net.trainParam.show</code>	25	Epochs between displays (NaN for no displays)
<code>net.trainParam.time</code>	inf	Maximum time to train in seconds

### Network Use

You can create a standard network that uses `traingd` with `feedforwardnet` or `cascadeforwardnet`. To prepare a custom network to be trained with `traingd`,

- 1 Set `net.trainFcn` to `'traingd'`. This sets `net.trainParam` to `traingd`'s default parameters.
- 2 Set `net.trainParam` properties to desired values.

In either case, calling `train` with the resulting network trains the network with `traingd`.

See `help feedforwardnet` and `help cascadeforwardnet` for examples.

## More About

### Gradient Descent Backpropagation

The batch steepest descent training function is `traingd`. The weights and biases are updated in the direction of the negative gradient of the performance function. If you want to train a network using batch steepest descent, you should set the network `trainFcn` to `traingd`, and then call the function `train`. There is only one training function associated with a given network.

There are seven training parameters associated with `traingd`:

- `epochs`
- `show`
- `goal`
- `time`
- `min_grad`
- `max_fail`
- `lr`

The learning rate `lr` is multiplied times the negative of the gradient to determine the changes to the weights and biases. The larger the learning rate, the bigger the step. If the learning rate is made too large, the algorithm becomes unstable. If the learning rate is set too small, the algorithm takes a long time to converge. See page 12-8 of [HDB96] for a discussion of the choice of learning rate.

The training status is displayed for every `show` iterations of the algorithm. (If `show` is set to `NaN`, then the training status is never displayed.) The other parameters determine when the training stops. The training stops if the number of iterations exceeds `epochs`, if the performance function drops below `goal`, if the magnitude of the gradient is less than `mingrad`, or if the training time is longer than `time` seconds. `max_fail`, which is associated with the early stopping technique, is discussed in *Improving Generalization*.

The following code creates a training set of inputs `p` and targets `t`. For batch training, all the input vectors are placed in one matrix.

```
p = [-1 -1 2 2; 0 5 0 5];  
t = [-1 -1 1 1];
```

Create the feedforward network.

```
net = feedforwardnet(3,'traingd');
```

In this simple example, turn off a feature that is introduced later.

```
net.divideFcn = '';
```

At this point, you might want to modify some of the default training parameters.

```
net.trainParam.show = 50;  
net.trainParam.lr = 0.05;  
net.trainParam.epochs = 300;  
net.trainParam.goal = 1e-5;
```

If you want to use the default training parameters, the preceding commands are not necessary.

Now you are ready to train the network.

```
[net,tr] = train(net,p,t);
```

The training record `tr` contains information about the progress of training.

Now you can simulate the trained network to obtain its response to the inputs in the training set.

```
a = net(p)
a =
    -1.0026    -0.9962     1.0010     0.9960
```

Try the *Neural Network Design* demonstration `nnd12sd1` [HDB96] for an illustration of the performance of the batch gradient descent algorithm.

### Algorithms

`traingd` can train any network as long as its weight, net input, and transfer functions have derivative functions.

Backpropagation is used to calculate derivatives of performance `perf` with respect to the weight and bias variables `X`. Each variable is adjusted according to gradient descent:

```
dX = lr * dperf/dX
```

Training stops when any of these conditions occurs:

- The maximum number of `epochs` (repetitions) is reached.
- The maximum amount of `time` is exceeded.
- Performance is minimized to the `goal`.
- The performance gradient falls below `min_grad`.
- Validation performance has increased more than `max_fail` times since the last time it decreased (when using validation).

### See Also

`traingda` | `traingdm` | `traingdx` | `trainlm`

**Introduced before R2006a**



# traingda

Gradient descent with adaptive learning rate backpropagation

## Syntax

```
net.trainFcn = 'traingda'
[net,tr] = train(net,...)
```

## Description

`traingda` is a network training function that updates weight and bias values according to gradient descent with adaptive learning rate.

`net.trainFcn = 'traingda'` sets the network `trainFcn` property.

`[net,tr] = train(net,...)` trains the network with `traingda`.

Training occurs according to `traingda` training parameters, shown here with their default values:

<code>net.trainParam.epochs</code>	1000	Maximum number of epochs to train
<code>net.trainParam.goal</code>	0	Performance goal
<code>net.trainParam.lr</code>	0.01	Learning rate
<code>net.trainParam.lr_inc</code>	1.05	Ratio to increase learning rate
<code>net.trainParam.lr_dec</code>	0.7	Ratio to decrease learning rate
<code>net.trainParam.max_fail</code>	6	Maximum validation failures
<code>net.trainParam.max_perf_inc</code>	1.04	Maximum performance increase
<code>net.trainParam.min_grad</code>	1e-5	Minimum performance gradient
<code>net.trainParam.show</code>	25	Epochs between displays (NaN for no displays)
<code>net.trainParam.showCommandLine</code>	false	Generate command-line output
<code>net.trainParam.showWindow</code>	true	Show training GUI
<code>net.trainParam.time</code>	inf	Maximum time to train in seconds

## Network Use

You can create a standard network that uses `traingda` with `feedforwardnet` or `cascadeforwardnet`. To prepare a custom network to be trained with `traingda`,

- 1 Set `net.trainFcn` to `'traingda'`. This sets `net.trainParam` to `traingda`'s default parameters.
- 2 Set `net.trainParam` properties to desired values.

In either case, calling `train` with the resulting network trains the network with `traingda`.

See `help feedforwardnet` and `help cascadeforwardnet` for examples.

## More About

### Gradient Descent with Adaptive Learning Rate Backpropagation

With standard steepest descent, the learning rate is held constant throughout training. The performance of the algorithm is very sensitive to the proper setting of the learning rate. If the learning rate is set too high, the algorithm can oscillate and become unstable. If the learning rate is too small, the algorithm takes too long to converge. It is not practical to determine the optimal setting for the learning rate before training, and, in fact, the optimal learning rate changes during the training process, as the algorithm moves across the performance surface.

You can improve the performance of the steepest descent algorithm if you allow the learning rate to change during the training process. An adaptive learning rate attempts to keep the learning step size as large as possible while keeping learning stable. The learning rate is made responsive to the complexity of the local error surface.

An adaptive learning rate requires some changes in the training procedure used by `traingd`. First, the initial network output and error are calculated. At each epoch new weights and biases are calculated using the current learning rate. New outputs and errors are then calculated.

As with momentum, if the new error exceeds the old error by more than a predefined ratio, `max_perf_inc` (typically 1.04), the new weights and biases are discarded. In addition, the learning rate is decreased (typically by multiplying by `lr_dec = 0.7`). Otherwise, the new weights, etc., are kept. If the new error is less than the old error, the learning rate is increased (typically by multiplying by `lr_inc = 1.05`).

This procedure increases the learning rate, but only to the extent that the network can learn without large error increases. Thus, a near-optimal learning rate is obtained for the local terrain. When a larger learning rate could result in stable learning, the learning rate is increased. When the learning rate is too high to guarantee a decrease in error, it is decreased until stable learning resumes.

Try the *Neural Network Design* demonstration `nnd12v1` [HDB96] for an illustration of the performance of the variable learning rate algorithm.

Backpropagation training with an adaptive learning rate is implemented with the function `traingda`, which is called just like `traingd`, except for the additional training parameters `max_perf_inc`, `lr_dec`, and `lr_inc`. Here is how it is called to train the previous two-layer network:

```
p = [-1 -1 2 2; 0 5 0 5];
t = [-1 -1 1 1];
net = feedforwardnet(3,'traingda');
net.trainParam.lr = 0.05;
net.trainParam.lr_inc = 1.05;
net = train(net,p,t);
y = net(p)
```

## Algorithms

`traingda` can train any network as long as its weight, net input, and transfer functions have derivative functions.

Backpropagation is used to calculate derivatives of performance `dperf` with respect to the weight and bias variables `X`. Each variable is adjusted according to gradient descent:

$$dX = lr * dperf / dX$$

At each epoch, if performance decreases toward the goal, then the learning rate is increased by the factor `lr_inc`. If performance increases by more than the factor `max_perf_inc`, the learning rate is adjusted by the factor `lr_dec` and the change that increased the performance is not made.

Training stops when any of these conditions occurs:

- The maximum number of `epochs` (repetitions) is reached.
- The maximum amount of `time` is exceeded.
- Performance is minimized to the `goal`.
- The performance gradient falls below `min_grad`.
- Validation performance has increased more than `max_fail` times since the last time it decreased (when using validation).

### **See Also**

`traingd` | `traingdm` | `traingdx` | `trainlm`

**Introduced before R2006a**

## traingdm

Gradient descent with momentum backpropagation

### Syntax

```
net.trainFcn = 'traingdm'  
[net,tr] = train(net,...)
```

### Description

`traingdm` is a network training function that updates weight and bias values according to gradient descent with momentum.

`net.trainFcn = 'traingdm'` sets the network `trainFcn` property.

`[net,tr] = train(net,...)` trains the network with `traingdm`.

Training occurs according to `traingdm` training parameters, shown here with their default values:

<code>net.trainParam.epochs</code>	1000	Maximum number of epochs to train
<code>net.trainParam.goal</code>	0	Performance goal
<code>net.trainParam.lr</code>	0.01	Learning rate
<code>net.trainParam.max_fail</code>	6	Maximum validation failures
<code>net.trainParam.mc</code>	0.9	Momentum constant
<code>net.trainParam.min_grad</code>	1e-5	Minimum performance gradient
<code>net.trainParam.show</code>	25	Epochs between showing progress
<code>net.trainParam.showCommandLine</code>	false	Generate command-line output
<code>net.trainParam.showWindow</code>	true	Show training GUI
<code>net.trainParam.time</code>	inf	Maximum time to train in seconds

### Network Use

You can create a standard network that uses `traingdm` with `feedforwardnet` or `cascadeforwardnet`. To prepare a custom network to be trained with `traingdm`,

- 1 Set `net.trainFcn` to `'traingdm'`. This sets `net.trainParam` to `traingdm`'s default parameters.
- 2 Set `net.trainParam` properties to desired values.

In either case, calling `train` with the resulting network trains the network with `traingdm`.

See `help feedforwardnet` and `help cascadeforwardnet` for examples.

## More About

### Gradient Descent with Momentum

In addition to `traingd`, there are three other variations of gradient descent.

Gradient descent with momentum, implemented by `traingdm`, allows a network to respond not only to the local gradient, but also to recent trends in the error surface. Acting like a lowpass filter, momentum allows the network to ignore small features in the error surface. Without momentum a network can get stuck in a shallow local minimum. With momentum a network can slide through such a minimum. See page 12-9 of [HDB96] for a discussion of momentum.

Gradient descent with momentum depends on two training parameters. The parameter `lr` indicates the learning rate, similar to the simple gradient descent. The parameter `mc` is the momentum constant that defines the amount of momentum. `mc` is set between 0 (no momentum) and values close to 1 (lots of momentum). A momentum constant of 1 results in a network that is completely insensitive to the local gradient and, therefore, does not learn properly.

```
p = [-1 -1 2 2; 0 5 0 5];
t = [-1 -1 1 1];
net = feedforwardnet(3,'traingdm');
net.trainParam.lr = 0.05;
net.trainParam.mc = 0.9;
net = train(net,p,t);
y = net(p)
```

Try the *Neural Network Design* demonstration `nnd12mo` [HDB96] for an illustration of the performance of the batch momentum algorithm.

## Algorithms

`traingdm` can train any network as long as its weight, net input, and transfer functions have derivative functions.

Backpropagation is used to calculate derivatives of performance `perf` with respect to the weight and bias variables  $X$ . Each variable is adjusted according to gradient descent with momentum,

$$dX = mc*dXprev + lr*(1-mc)*dperf/dX$$

where `dXprev` is the previous change to the weight or bias.

Training stops when any of these conditions occurs:

- The maximum number of `epochs` (repetitions) is reached.
- The maximum amount of `time` is exceeded.
- Performance is minimized to the `goal`.
- The performance gradient falls below `min_grad`.
- Validation performance has increased more than `max_fail` times since the last time it decreased (when using validation).

## See Also

`traingd` | `traingda` | `traingdx` | `trainlm`

**Introduced before R2006a**

# traingdx

Gradient descent with momentum and adaptive learning rate backpropagation

## Syntax

```
net.trainFcn = 'traingdx'
[net,tr] = train(net,...)
```

## Description

`traingdx` is a network training function that updates weight and bias values according to gradient descent momentum and an adaptive learning rate.

`net.trainFcn = 'traingdx'` sets the network `trainFcn` property.

`[net,tr] = train(net,...)` trains the network with `traingdx`.

Training occurs according to `traingdx` training parameters, shown here with their default values:

<code>net.trainParam.epochs</code>	1000	Maximum number of epochs to train
<code>net.trainParam.goal</code>	0	Performance goal
<code>net.trainParam.lr</code>	0.01	Learning rate
<code>net.trainParam.lr_inc</code>	1.05	Ratio to increase learning rate
<code>net.trainParam.lr_dec</code>	0.7	Ratio to decrease learning rate
<code>net.trainParam.max_fail</code>	6	Maximum validation failures
<code>net.trainParam.max_perf_inc</code>	1.04	Maximum performance increase
<code>net.trainParam.mc</code>	0.9	Momentum constant
<code>net.trainParam.min_grad</code>	1e-5	Minimum performance gradient
<code>net.trainParam.show</code>	25	Epochs between displays (NaN for no displays)
<code>net.trainParam.showCommandLine</code>	false	Generate command-line output
<code>net.trainParam.showWindow</code>	true	Show training GUI
<code>net.trainParam.time</code>	inf	Maximum time to train in seconds

## Network Use

You can create a standard network that uses `traingdx` with `feedforwardnet` or `cascadeforwardnet`. To prepare a custom network to be trained with `traingdx`,

- 1 Set `net.trainFcn` to `'traingdx'`. This sets `net.trainParam` to `traingdx`'s default parameters.
- 2 Set `net.trainParam` properties to desired values.

In either case, calling `train` with the resulting network trains the network with `traingdx`.

See `help feedforwardnet` and `help cascadeforwardnet` for examples.

## Algorithms

The function `traingdx` combines adaptive learning rate with momentum training. It is invoked in the same way as `traingda`, except that it has the momentum coefficient `mc` as an additional training parameter.

`traingdx` can train any network as long as its weight, net input, and transfer functions have derivative functions.

Backpropagation is used to calculate derivatives of performance `perf` with respect to the weight and bias variables `X`. Each variable is adjusted according to gradient descent with momentum,

$$dX = mc*dXprev + lr*mc*dperf/dX$$

where `dXprev` is the previous change to the weight or bias.

For each epoch, if performance decreases toward the goal, then the learning rate is increased by the factor `lr_inc`. If performance increases by more than the factor `max_perf_inc`, the learning rate is adjusted by the factor `lr_dec` and the change that increased the performance is not made.

Training stops when any of these conditions occurs:

- The maximum number of `epochs` (repetitions) is reached.
- The maximum amount of `time` is exceeded.
- Performance is minimized to the `goal`.
- The performance gradient falls below `min_grad`.
- Validation performance has increased more than `max_fail` times since the last time it decreased (when using validation).

## See Also

`traingd` | `traingda` | `traingdm` | `trainlm`

**Introduced before R2006a**



# trainlm

Levenberg-Marquardt backpropagation

## Syntax

```
net.trainFcn = 'trainlm'
[net,tr] = train(net,...)
```

## Description

`trainlm` is a network training function that updates weight and bias values according to Levenberg-Marquardt optimization.

`trainlm` is often the fastest backpropagation algorithm in the toolbox, and is highly recommended as a first-choice supervised algorithm, although it does require more memory than other algorithms.

`net.trainFcn = 'trainlm'` sets the network `trainFcn` property.

`[net,tr] = train(net,...)` trains the network with `trainlm`.

Training occurs according to `trainlm` training parameters, shown here with their default values:

<code>net.trainParam.epochs</code>	1000	Maximum number of epochs to train
<code>net.trainParam.goal</code>	0	Performance goal
<code>net.trainParam.max_fail</code>	6	Maximum validation failures
<code>net.trainParam.min_grad</code>	1e-7	Minimum performance gradient
<code>net.trainParam.mu</code>	0.001	Initial mu
<code>net.trainParam.mu_dec</code>	0.1	mu decrease factor
<code>net.trainParam.mu_inc</code>	10	mu increase factor
<code>net.trainParam.mu_max</code>	1e10	Maximum mu
<code>net.trainParam.show</code>	25	Epochs between displays (NaN for no displays)
<code>net.trainParam.showCommandLine</code>	false	Generate command-line output
<code>net.trainParam.showWindow</code>	true	Show training GUI
<code>net.trainParam.time</code>	inf	Maximum time to train in seconds

Validation vectors are used to stop training early if the network performance on the validation vectors fails to improve or remains the same for `max_fail` epochs in a row. Test vectors are used as a further check that the network is generalizing well, but do not have any effect on training.

## Network Use

You can create a standard network that uses `trainlm` with `feedforwardnet` or `cascadeforwardnet`.

To prepare a custom network to be trained with `trainlm`,

- 1 Set `net.trainFcn` to `'trainlm'`. This sets `net.trainParam` to `trainlm`'s default parameters.
- 2 Set `net.trainParam` properties to desired values.

In either case, calling `train` with the resulting network trains the network with `trainlm`.

See `help feedforwardnet` and `help cascadeforwardnet` for examples.

## Examples

### Train Neural Network Using `trainlm` Train Function

This example shows how to train a neural network using the `trainlm` train function.

Here a neural network is trained to predict body fat percentages.

```
[x, t] = bodyfat_dataset;
net = feedforwardnet(10, 'trainlm');
net = train(net, x, t);
y = net(x);
```

## Limitations

This function uses the Jacobian for calculations, which assumes that performance is a mean or sum of squared errors. Therefore, networks trained with this function must use either the `mse` or `sse` performance function.

## More About

### Levenberg-Marquardt Algorithm

Like the quasi-Newton methods, the Levenberg-Marquardt algorithm was designed to approach second-order training speed without having to compute the Hessian matrix. When the performance function has the form of a sum of squares (as is typical in training feedforward networks), then the Hessian matrix can be approximated as

$$\mathbf{H} = \mathbf{J}^T \mathbf{J}$$

and the gradient can be computed as

$$\mathbf{g} = \mathbf{J}^T \mathbf{e}$$

where  $\mathbf{J}$  is the Jacobian matrix that contains first derivatives of the network errors with respect to the weights and biases, and  $\mathbf{e}$  is a vector of network errors. The Jacobian matrix can be computed through a standard backpropagation technique (see [HaMe94]) that is much less complex than computing the Hessian matrix.

The Levenberg-Marquardt algorithm uses this approximation to the Hessian matrix in the following Newton-like update:

$$\mathbf{x}_{k+1} = \mathbf{x}_k - [\mathbf{J}^T \mathbf{J} + \mu \mathbf{I}]^{-1} \mathbf{J}^T \mathbf{e}$$

When the scalar  $\mu$  is zero, this is just Newton's method, using the approximate Hessian matrix. When  $\mu$  is large, this becomes gradient descent with a small step size. Newton's method is faster and more accurate near an error minimum, so the aim is to shift toward Newton's method as quickly as possible. Thus,  $\mu$  is decreased after each successful step (reduction in performance function) and is increased only when a tentative step would increase the performance function. In this way, the performance function is always reduced at each iteration of the algorithm.

The original description of the Levenberg-Marquardt algorithm is given in [Marq63]. The application of Levenberg-Marquardt to neural network training is described in [HaMe94] and starting on page 12-19 of [HDB96]. This algorithm appears to be the fastest method for training moderate-sized feedforward neural networks (up to several hundred weights). It also has an efficient implementation in MATLAB® software, because the solution of the matrix equation is a built-in function, so its attributes become even more pronounced in a MATLAB environment.

Try the *Neural Network Design* demonstration `nnd12m` [HDB96] for an illustration of the performance of the batch Levenberg-Marquardt algorithm.

## Algorithms

`trainlm` supports training with validation and test vectors if the network's `NET.divideFcn` property is set to a data division function. Validation vectors are used to stop training early if the network performance on the validation vectors fails to improve or remains the same for `max_fail` epochs in a row. Test vectors are used as a further check that the network is generalizing well, but do not have any effect on training.

`trainlm` can train any network as long as its weight, net input, and transfer functions have derivative functions.

Backpropagation is used to calculate the Jacobian  $jX$  of performance `perf` with respect to the weight and bias variables  $X$ . Each variable is adjusted according to Levenberg-Marquardt,

$$\begin{aligned} jj &= jX * jX \\ je &= jX * E \\ dX &= -(jj+I*mu) \setminus je \end{aligned}$$

where  $E$  is all errors and  $I$  is the identity matrix.

The adaptive value  $\mu$  is increased by `mu_inc` until the change above results in a reduced performance value. The change is then made to the network and  $\mu$  is decreased by `mu_dec`.

Training stops when any of these conditions occurs:

- The maximum number of epochs (repetitions) is reached.
- The maximum amount of `time` is exceeded.
- Performance is minimized to the `goal`.
- The performance gradient falls below `min_grad`.
- $\mu$  exceeds `mu_max`.
- Validation performance has increased more than `max_fail` times since the last time it decreased (when using validation).

**Introduced before R2006a**

## trainoss

One-step secant backpropagation

### Syntax

```
net.trainFcn = 'trainoss'
[net,tr] = train(net,...)
```

### Description

`trainoss` is a network training function that updates weight and bias values according to the one-step secant method.

`net.trainFcn = 'trainoss'` sets the network `trainFcn` property.

`[net,tr] = train(net,...)` trains the network with `trainoss`.

Training occurs according to `trainoss` training parameters, shown here with their default values:

<code>net.trainParam.epochs</code>	1000	Maximum number of epochs to train
<code>net.trainParam.goal</code>	0	Performance goal
<code>net.trainParam.max_fail</code>	6	Maximum validation failures
<code>net.trainParam.min_grad</code>	1e-10	Minimum performance gradient
<code>net.trainParam.searchFcn</code>	'srchbac'	Name of line search routine to use
<code>net.trainParam.show</code>	25	Epochs between displays (NaN for no displays)
<code>net.trainParam.showCommandLine</code>	false	Generate command-line output
<code>net.trainParam.showWindow</code>	true	Show training GUI
<code>net.trainParam.time</code>	inf	Maximum time to train in seconds

Parameters related to line search methods (not all used for all methods):

<code>net.trainParam.sca1_tol</code>	20	Divide into <code>delta</code> to determine tolerance for linear search.
<code>net.trainParam.alpha</code>	0.001	Scale factor that determines sufficient reduction in <code>perf</code>
<code>net.trainParam.beta</code>	0.1	Scale factor that determines sufficiently large step size
<code>net.trainParam.delta</code>	0.01	Initial step size in interval location step
<code>net.trainParam.gama</code>	0.1	Parameter to avoid small reductions in performance, usually set to 0.1 (see <code>srch_cha</code> )
<code>net.trainParam.low_lim</code>	0.1	Lower limit on change in step size
<code>net.trainParam.up_lim</code>	0.5	Upper limit on change in step size
<code>net.trainParam.maxstep</code>	100	Maximum step length
<code>net.trainParam.minstep</code>	1.0e-6	Minimum step length

<code>net.trainParam.bmax</code>	26	Maximum step size
----------------------------------	----	-------------------

## Network Use

You can create a standard network that uses `trainoss` with `feedforwardnet` or `cascadeforwardnet`. To prepare a custom network to be trained with `trainoss`:

- 1 Set `net.trainFcn` to `'trainoss'`. This sets `net.trainParam` to `trainoss`'s default parameters.
- 2 Set `net.trainParam` properties to desired values.

In either case, calling `train` with the resulting network trains the network with `trainoss`.

## Examples

### Train Neural Network Using `trainoss` Train Function

This example shows how to train a neural network using the `trainoss` train function.

Here a neural network is trained to predict body fat percentages.

```
[x, t] = bodyfat_dataset;
net = feedforwardnet(10, 'trainoss');
net = train(net, x, t);
y = net(x);
```

## More About

### One Step Secant Method

Because the BFGS algorithm requires more storage and computation in each iteration than the conjugate gradient algorithms, there is need for a secant approximation with smaller storage and computation requirements. The one step secant (OSS) method is an attempt to bridge the gap between the conjugate gradient algorithms and the quasi-Newton (secant) algorithms. This algorithm does not store the complete Hessian matrix; it assumes that at each iteration, the previous Hessian was the identity matrix. This has the additional advantage that the new search direction can be calculated without computing a matrix inverse.

The one step secant method is described in [Batt92]. This algorithm requires less storage and computation per epoch than the BFGS algorithm. It requires slightly more storage and computation per epoch than the conjugate gradient algorithms. It can be considered a compromise between full quasi-Newton algorithms and conjugate gradient algorithms.

## Algorithms

`trainoss` can train any network as long as its weight, net input, and transfer functions have derivative functions.

Backpropagation is used to calculate derivatives of performance `perf` with respect to the weight and bias variables  $X$ . Each variable is adjusted according to the following:

$$X = X + a*dX;$$

where  $dX$  is the search direction. The parameter  $a$  is selected to minimize the performance along the search direction. The line search function `searchFcn` is used to locate the minimum point. The first search direction is the negative of the gradient of performance. In succeeding iterations the search direction is computed from the new gradient and the previous steps and gradients, according to the following formula:

$$dX = -gX + Ac*X\_step + Bc*dgX;$$

where  $gX$  is the gradient,  $X\_step$  is the change in the weights on the previous iteration, and  $dgX$  is the change in the gradient from the last iteration. See Battiti (*Neural Computation*, Vol. 4, 1992, pp. 141-166) for a more detailed discussion of the one-step secant algorithm.

Training stops when any of these conditions occurs:

- The maximum number of `epochs` (repetitions) is reached.
- The maximum amount of `time` is exceeded.
- Performance is minimized to the `goal`.
- The performance gradient falls below `min_grad`.
- Validation performance has increased more than `max_fail` times since the last time it decreased (when using validation).

## References

Battiti, R., "First and second order methods for learning: Between steepest descent and Newton's method," *Neural Computation*, Vol. 4, No. 2, 1992, pp. 141-166

## See Also

`trainbfg` | `traincgb` | `traincgf` | `traincgp` | `traingda` | `traingdm` | `traingdx` | `trainlm` | `trainrp` | `trainscg`

**Introduced before R2006a**

# trainr

Random order incremental training with learning functions

## Syntax

```
net.trainFcn = 'trainr'
[net,tr] = train(net,...)
```

## Description

`trainr` is not called directly. Instead it is called by `train` for networks whose `net.trainFcn` property is set to `'trainr'`, thus:

`net.trainFcn = 'trainr'` sets the network `trainFcn` property.

`[net,tr] = train(net,...)` trains the network with `trainr`.

`trainr` trains a network with weight and bias learning rules with incremental updates after each presentation of an input. Inputs are presented in random order.

Training occurs according to `trainr` training parameters, shown here with their default values:

<code>net.trainParam.epochs</code>	1000	Maximum number of epochs to train
<code>net.trainParam.goal</code>	0	Performance goal
<code>net.trainParam.max_fail</code>	6	Maximum validation failures
<code>net.trainParam.show</code>	25	Epochs between displays (NaN for no displays)
<code>net.trainParam.showCommandLine</code>	false	Generate command-line output
<code>net.trainParam.showWindow</code>	true	Show training GUI
<code>net.trainParam.time</code>	inf	Maximum time to train in seconds

## Network Use

You can create a standard network that uses `trainr` by calling `competlayer` or `selforgmap`. To prepare a custom network to be trained with `trainr`,

- 1 Set `net.trainFcn` to `'trainr'`. This sets `net.trainParam` to `trainr`'s default parameters.
- 2 Set each `net.inputWeights{i,j}.learnFcn` to a learning function.
- 3 Set each `net.layerWeights{i,j}.learnFcn` to a learning function.
- 4 Set each `net.biases{i}.learnFcn` to a learning function. (Weight and bias learning parameters are automatically set to default values for the given learning function.)

To train the network,

- 1 Set `net.trainParam` properties to desired values.
- 2 Set weight and bias learning parameters to desired values.

3 Call `train`.

See `help competlayer` and `help selforgmap` for training examples.

### Algorithms

For each epoch, all training vectors (or sequences) are each presented once in a different random order, with the network and weight and bias values updated accordingly after each individual presentation.

Training stops when any of these conditions is met:

- The maximum number of `epochs` (repetitions) is reached.
- Performance is minimized to the `goal`.
- The maximum amount of `time` is exceeded.

### See Also

`train`

**Introduced before R2006a**



# trainrp

Resilient backpropagation

## Syntax

```
net.trainFcn = 'trainrp'
[net,tr] = train(net,...)
```

## Description

`trainrp` is a network training function that updates weight and bias values according to the resilient backpropagation algorithm (Rprop).

`net.trainFcn = 'trainrp'` sets the network `trainFcn` property.

`[net,tr] = train(net,...)` trains the network with `trainrp`.

Training occurs according to `trainrp` training parameters, shown here with their default values:

<code>net.trainParam.epochs</code>	1000	Maximum number of epochs to train
<code>net.trainParam.show</code>	25	Epochs between displays (NaN for no displays)
<code>net.trainParam.showCommandLine</code>	false	Generate command-line output
<code>net.trainParam.showWindow</code>	true	Show training GUI
<code>net.trainParam.goal</code>	0	Performance goal
<code>net.trainParam.time</code>	inf	Maximum time to train in seconds
<code>net.trainParam.min_grad</code>	1e-5	Minimum performance gradient
<code>net.trainParam.max_fail</code>	6	Maximum validation failures
<code>net.trainParam.lr</code>	0.01	Learning rate
<code>net.trainParam.delt_inc</code>	1.2	Increment to weight change
<code>net.trainParam.delt_dec</code>	0.5	Decrement to weight change
<code>net.trainParam.delta0</code>	0.07	Initial weight change
<code>net.trainParam.deltamax</code>	50.0	Maximum weight change

## Network Use

You can create a standard network that uses `trainrp` with `feedforwardnet` or `cascadeforwardnet`.

To prepare a custom network to be trained with `trainrp`,

- 1 Set `net.trainFcn` to `'trainrp'`. This sets `net.trainParam` to `trainrp`'s default parameters.
- 2 Set `net.trainParam` properties to desired values.

In either case, calling `train` with the resulting network trains the network with `trainrp`.

## Examples

Here is a problem consisting of inputs `p` and targets `t` to be solved with a network.

```
p = [0 1 2 3 4 5];  
t = [0 0 0 1 1 1];
```

A two-layer feed-forward network with two hidden neurons and this training function is created.

Create and test a network.

```
net = feedforwardnet(2, 'trainrp');
```

Here the network is trained and retested.

```
net.trainParam.epochs = 50;  
net.trainParam.show = 10;  
net.trainParam.goal = 0.1;  
net = train(net,p,t);  
a = net(p)
```

See `help feedforwardnet` and `help cascadeforwardnet` for other examples.

## More About

### Resilient Backpropagation

Multilayer networks typically use sigmoid transfer functions in the hidden layers. These functions are often called “squashing” functions, because they compress an infinite input range into a finite output range. Sigmoid functions are characterized by the fact that their slopes must approach zero as the input gets large. This causes a problem when you use steepest descent to train a multilayer network with sigmoid functions, because the gradient can have a very small magnitude and, therefore, cause small changes in the weights and biases, even though the weights and biases are far from their optimal values.

The purpose of the resilient backpropagation (Rprop) training algorithm is to eliminate these harmful effects of the magnitudes of the partial derivatives. Only the sign of the derivative can determine the direction of the weight update; the magnitude of the derivative has no effect on the weight update. The size of the weight change is determined by a separate update value. The update value for each weight and bias is increased by a factor `delt_inc` whenever the derivative of the performance function with respect to that weight has the same sign for two successive iterations. The update value is decreased by a factor `delt_dec` whenever the derivative with respect to that weight changes sign from the previous iteration. If the derivative is zero, the update value remains the same. Whenever the weights are oscillating, the weight change is reduced. If the weight continues to change in the same direction for several iterations, the magnitude of the weight change increases. A complete description of the Rprop algorithm is given in [RiBr93].

The following code recreates the previous network and trains it using the Rprop algorithm. The training parameters for `trainrp` are `epochs`, `show`, `goal`, `time`, `min_grad`, `max_fail`, `delt_inc`, `delt_dec`, `delta0`, and `deltamax`. The first eight parameters have been previously discussed. The last two are the initial step size and the maximum step size, respectively. The performance of Rprop is not very sensitive to the settings of the training parameters. For the example below, the training parameters are left at the default values:

```
p = [-1 -1 2 2;0 5 0 5];  
t = [-1 -1 1 1];
```

```
net = feedforwardnet(3,'trainrp');
net = train(net,p,t);
y = net(p)
```

`rprop` is generally much faster than the standard steepest descent algorithm. It also has the nice property that it requires only a modest increase in memory requirements. You do need to store the update values for each weight and bias, which is equivalent to storage of the gradient.

## Algorithms

`trainrp` can train any network as long as its weight, net input, and transfer functions have derivative functions.

Backpropagation is used to calculate derivatives of performance `perf` with respect to the weight and bias variables `X`. Each variable is adjusted according to the following:

```
dX = deltaX.*sign(gX);
```

where the elements of `deltaX` are all initialized to `delta0`, and `gX` is the gradient. At each iteration the elements of `deltaX` are modified. If an element of `gX` changes sign from one iteration to the next, then the corresponding element of `deltaX` is decreased by `delta_dec`. If an element of `gX` maintains the same sign from one iteration to the next, then the corresponding element of `deltaX` is increased by `delta_inc`. See Riedmiller, M., and H. Braun, "A direct adaptive method for faster backpropagation learning: The RPROP algorithm," *Proceedings of the IEEE International Conference on Neural Networks*, 1993, pp. 586-591.

Training stops when any of these conditions occurs:

- The maximum number of `epochs` (repetitions) is reached.
- The maximum amount of `time` is exceeded.
- Performance is minimized to the `goal`.
- The performance gradient falls below `min_grad`.
- Validation performance has increased more than `max_fail` times since the last time it decreased (when using validation).

## References

Riedmiller, M., and H. Braun, "A direct adaptive method for faster backpropagation learning: The RPROP algorithm," *Proceedings of the IEEE International Conference on Neural Networks*, 1993, pp. 586-591.

## See Also

`trainbfg` | `traincgb` | `traincgf` | `traincgp` | `traingda` | `traingdm` | `traingdx` | `trainlm` | `trainoss` | `trainscg`

**Introduced before R2006a**

## trainru

Unsupervised random order weight/bias training

### Syntax

```
net.trainFcn = 'trainru'
[net,tr] = train(net,...)
```

### Description

`trainru` is not called directly. Instead it is called by `train` for networks whose `net.trainFcn` property is set to `'trainru'`, thus:

`net.trainFcn = 'trainru'` sets the network `trainFcn` property.

`[net,tr] = train(net,...)` trains the network with `trainru`.

`trainru` trains a network with weight and bias learning rules with incremental updates after each presentation of an input. Inputs are presented in random order.

Training occurs according to `trainru` training parameters, shown here with their default values:

<code>net.trainParam.epochs</code>	1000	Maximum number of epochs to train
<code>net.trainParam.show</code>	25	Epochs between displays (NaN for no displays)
<code>net.trainParam.showCommandLine</code>	false	Generate command-line output
<code>net.trainParam.showWindow</code>	true	Show training GUI
<code>net.trainParam.time</code>	Inf	Maximum time to train in seconds

### Network Use

To prepare a custom network to be trained with `trainru`,

- 1 Set `net.trainFcn` to `'trainru'`. This sets `net.trainParam` to `trainru`'s default parameters.
- 2 Set each `net.inputWeights{i,j}.learnFcn` to a learning function.
- 3 Set each `net.layerWeights{i,j}.learnFcn` to a learning function.
- 4 Set each `net.biases{i}.learnFcn` to a learning function. (Weight and bias learning parameters are automatically set to default values for the given learning function.)

To train the network,

- 1 Set `net.trainParam` properties to desired values.
- 2 Set weight and bias learning parameters to desired values.
- 3 Call `train`.

## Algorithms

For each epoch, all training vectors (or sequences) are each presented once in a different random order, with the network and weight and bias values updated accordingly after each individual presentation.

Training stops when any of these conditions is met:

- The maximum number of `epochs` (repetitions) is reached.
- The maximum amount of `time` is exceeded.

## See Also

`train` | `trainr`

**Introduced in R2010b**

## trains

Sequential order incremental training with learning functions

### Syntax

```
net.trainFcn = 'trains'
[net,tr] = train(net,...)
```

### Description

`trains` is not called directly. Instead it is called by `train` for networks whose `net.trainFcn` property is set to `'trains'`, thus:

`net.trainFcn = 'trains'` sets the network `trainFcn` property.

`[net,tr] = train(net,...)` trains the network with `trains`.

`trains` trains a network with weight and bias learning rules with sequential updates. The sequence of inputs is presented to the network with updates occurring after each time step.

This incremental training algorithm is commonly used for adaptive applications.

Training occurs according to `trains` training parameters, shown here with their default values:

<code>net.trainParam.epochs</code>	1000	Maximum number of epochs to train
<code>net.trainParam.goal</code>	0	Performance goal
<code>net.trainParam.show</code>	25	Epochs between displays (NaN for no displays)
<code>net.trainParam.showCommandLine</code>	false	Generate command-line output
<code>net.trainParam.showWindow</code>	true	Show training GUI
<code>net.trainParam.time</code>	Inf	Maximum time to train in seconds

### Network Use

You can create a standard network that uses `trains` for adapting by calling `perceptron` or `linearlayer`.

To prepare a custom network to adapt with `trains`,

- 1 Set `net.adaptFcn` to `'trains'`. This sets `net.adaptParam` to `trains`'s default parameters.
- 2 Set each `net.inputWeights{i,j}.learnFcn` to a learning function. Set each `net.layerWeights{i,j}.learnFcn` to a learning function. Set each `net.biases{i}.learnFcn` to a learning function. (Weight and bias learning parameters are automatically set to default values for the given learning function.)

To allow the network to adapt,

- 1 Set weight and bias learning parameters to desired values.

**2** Call `adapt`.

See `help perceptron` and `help linearlayer` for adaption examples.

## **Algorithms**

Each weight and bias is updated according to its learning function after each time step in the input sequence.

## **See Also**

`train` | `trainb` | `trainc` | `trainr`

**Introduced before R2006a**

## trainscg

Scaled conjugate gradient backpropagation

### Syntax

```
net.trainFcn = 'trainscg'
[net,tr] = train(net,...)
```

### Description

`trainscg` is a network training function that updates weight and bias values according to the scaled conjugate gradient method.

`net.trainFcn = 'trainscg'` sets the network `trainFcn` property.

`[net,tr] = train(net,...)` trains the network with `trainscg`.

Training occurs according to `trainscg` training parameters, shown here with their default values:

<code>net.trainParam.epochs</code>	1000	Maximum number of epochs to train
<code>net.trainParam.show</code>	25	Epochs between displays (NaN for no displays)
<code>net.trainParam.showCommandLine</code>	false	Generate command-line output
<code>net.trainParam.showWindow</code>	true	Show training GUI
<code>net.trainParam.goal</code>	0	Performance goal
<code>net.trainParam.time</code>	inf	Maximum time to train in seconds
<code>net.trainParam.min_grad</code>	1e-6	Minimum performance gradient
<code>net.trainParam.max_fail</code>	6	Maximum validation failures
<code>net.trainParam.sigma</code>	5.0e-5	Determine change in weight for second derivative approximation
<code>net.trainParam.lambda</code>	5.0e-7	Parameter for regulating the indefiniteness of the Hessian

### Network Use

You can create a standard network that uses `trainscg` with `feedforwardnet` or `cascadeforwardnet`. To prepare a custom network to be trained with `trainscg`,

- 1 Set `net.trainFcn` to `'trainscg'`. This sets `net.trainParam` to `trainscg`'s default parameters.
- 2 Set `net.trainParam` properties to desired values.

In either case, calling `train` with the resulting network trains the network with `trainscg`.



## Examples

Here is a problem consisting of inputs `p` and targets `t` to be solved with a network.

```
p = [0 1 2 3 4 5];
t = [0 0 0 1 1 1];
```

A two-layer feed-forward network with two hidden neurons and this training function is created.

```
net = feedforwardnet(2,'trainscg');
```

Here the network is trained and retested.

```
net = train(net,p,t);
a = net(p)
```

See `help feedforwardnet` and `help cascadeforwardnet` for other examples.

## Algorithms

`trainscg` can train any network as long as its weight, net input, and transfer functions have derivative functions. Backpropagation is used to calculate derivatives of performance `perf` with respect to the weight and bias variables  $X$ .

The scaled conjugate gradient algorithm is based on conjugate directions, as in `traincgp`, `traincgf`, and `traincgb`, but this algorithm does not perform a line search at each iteration. See Moller (*Neural Networks*, Vol. 6, 1993, pp. 525–533) for a more detailed discussion of the scaled conjugate gradient algorithm.

Training stops when any of these conditions occurs:

- The maximum number of epochs (repetitions) is reached.
- The maximum amount of `time` is exceeded.
- Performance is minimized to the `goal`.
- The performance gradient falls below `min_grad`.
- Validation performance has increased more than `max_fail` times since the last time it decreased (when using validation).

## References

Moller, *Neural Networks*, Vol. 6, 1993, pp. 525–533

## See Also

`trainbfg` | `traincgb` | `traincgf` | `traincgp` | `traingda` | `traingdm` | `traingdx` | `trainlm` | `trainoss` | `trainrp`

**Introduced before R2006a**

## tribas

Triangular basis transfer function

### Graph and Symbol

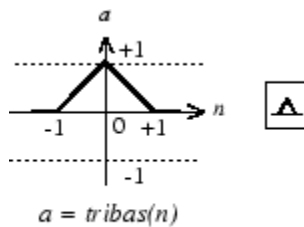

Triangular Basis Function

### Syntax

`A = tribas(N,FP)`

### Description

`tribas` is a neural transfer function. Transfer functions calculate a layer's output from its net input.

`A = tribas(N,FP)` takes `N` and optional function parameters,

<code>N</code>	S-by-Q matrix of net input (column) vectors
<code>FP</code>	Struct of function parameters (ignored)

and returns `A`, an S-by-Q matrix of the triangular basis function applied to each element of `N`.

`info = tribas('code')` can take the following forms to return specific information:

`tribas('name')` returns the name of this function.

`tribas('output',FP)` returns the [min max] output range.

`tribas('active',FP)` returns the [min max] active input range.

`tribas('fullderiv')` returns 1 or 0, depending on whether `dA_dN` is S-by-S-by-Q or S-by-Q.

`tribas('fpnames')` returns the names of the function parameters.

`tribas('fpdefaults')` returns the default function parameters.

### Examples

Here you create a plot of the `tribas` transfer function.

```
n = -5:0.1:5;  
a = tribas(n);  
plot(n,a)
```

Assign this transfer function to layer *i* of a network.

```
net.layers{i}.transferFcn = 'tribas';
```

## Algorithms

```
a = tribas(n) = 1 - abs(n), if -1 <= n <= 1  
              = 0, otherwise
```

## See Also

radbas | sim

**Introduced before R2006a**

## tritop

Triangle layer topology function

### Syntax

```
pos = tritop(dimensions)
```

### Description

`tritop` calculates neuron positions for layers whose neurons are arranged in an N-dimensional triangular grid.

`pos = tritop(dimensions)` takes one argument:

<code>dimensions</code>	Row vector of dimension sizes
-------------------------	-------------------------------

and returns an N-by-S matrix of N coordinate vectors, where N is the number of dimensions and S is the product of dimensions.

### Examples

#### Display Layer with Triangular Pattern

This example shows how to display a two-dimensional layer with 40 neurons arranged in an 8-by-5 triangular grid.

```
pos = tritop([8 5]);  
plotsom(pos)
```

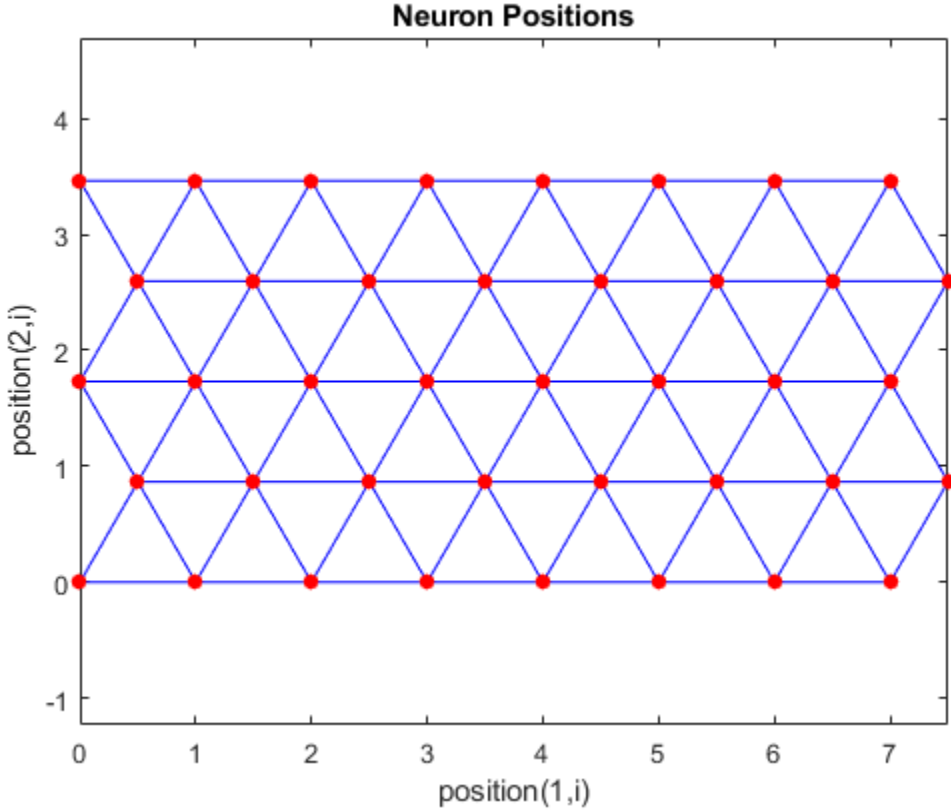

**See Also**

gridtop | hextop | randtop

**Introduced in R2010b**

## unconfigure

Unconfigure network inputs and outputs

### Syntax

```
unconfigure(net)
unconfigure(net, 'inputs', i)
unconfigure(net, 'outputs', i)
```

### Description

`unconfigure(net)` returns a network with its input and output sizes set to 0, its input and output processing settings and related weight initialization settings set to values consistent with zero-sized signals. The new network will be ready to be reconfigured for data of the same or different dimensions than it was previously configured for.

`unconfigure(net, 'inputs', i)` unconfigures the inputs indicated by the indices `i`. If no indices are specified, all inputs are unconfigured.

`unconfigure(net, 'outputs', i)` unconfigures the outputs indicated by the indices `i`. If no indices are specified, all outputs are unconfigured.

### Examples

Here a network is configured for a simple fitting problem, and then unconfigured.

```
[x,t] = simplefit_dataset;
net = fitnet(10);
view(net)
net = configure(net,x,t);
view(net)
net = unconfigure(net)
view(net)
```

### See Also

`configure` | `isconfigured`

**Introduced in R2010b**

## vec2ind

Convert vectors to indices

### Syntax

```
[ind,n] = vec2ind
```

### Description

`ind2vec` and `vec2ind(vec)` allow indices to be represented either by themselves or as vectors containing a 1 in the row of the index they represent.

`[ind,n] = vec2ind` takes one argument,

<code>vec</code>	Matrix of vectors, each containing a single 1
------------------	---

and returns

<code>ind</code>	The indices of the 1s
<code>n</code>	The number of rows in <code>vec</code>

### Examples

Here three vectors are converted to indices and back, while preserving the number of rows.

```
vec = [0 0 1 0; 1 0 0 0; 0 1 0 0]'
```

```
vec =
     0     1     0
     0     0     1
     1     0     0
     0     0     0
```

```
[ind,n] = vec2ind(vec)
```

```
ind =
     3     1     2
```

```
n =
     4
```

```
vec2 = full(ind2vec(ind,n))
```

```
vec2 =
     0     1     0
     0     0     1
     1     0     0
     0     0     0
```

### See Also

`ind2sub` | `ind2vec` | `sub2ind`

**Introduced before R2006a**



## view

View shallow neural network

### Syntax

```
view(net)
```

### Description

`view(net)` opens a window that shows your shallow neural network (specified in `net`) as a graphical diagram.

---

**Tip** To visualize deep learning networks, see Deep Network Designer.

---

### Example

#### View Neural Network

This example shows how to view the diagram of a pattern recognition network.

```
[x,t] = iris_dataset;
net = patternnet;
net = configure(net,x,t);
view(net)
```

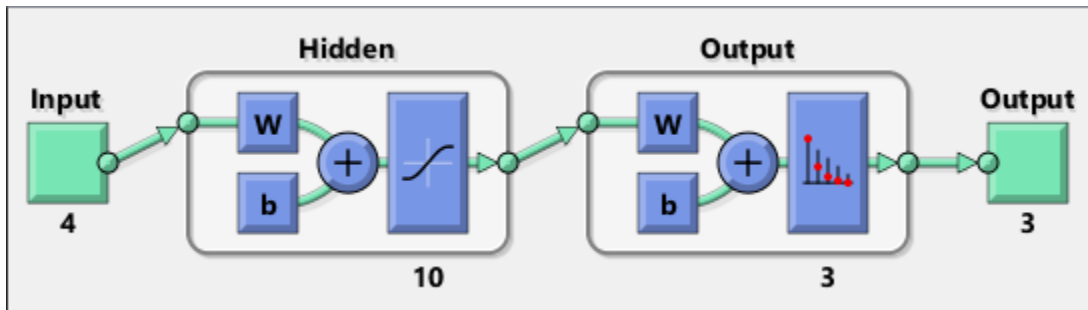

Introduced in R2008a

# Neural Net Fitting

Fit data by training a two-layer feed-forward network

## Description

The **Neural Net Fitting** app leads you through solving a data-fitting problem using a two-layer feed-forward network. It helps you select data, divide it into training, validation, and testing sets, define the network architecture, and train the network. You can select your own data from the MATLAB workspace or use one of the example datasets. After training the network, evaluate its performance using mean squared error and regression analysis. Further analyze the results using visualization tools such as a regression fit or histogram of the errors. You can then evaluate the performance of the network on a test set. If you are not satisfied with the results, you can retrain the network with modified settings or on a larger data set.

You can generate MATLAB scripts to reproduce results or customize the training process. You can also save the trained network to test on new data or use for solving similar fitting problems. The app also provides the option to generate various deployable versions of your trained network. For example, you can deploy the trained network using MATLAB Compiler, MATLAB Coder, or Simulink Coder tools.

## Required Products

- MATLAB
- Deep Learning Toolbox

## Open the Neural Net Fitting App

- MATLAB Toolstrip: On the **Apps** tab, under **Machine Learning**, click the app icon.
- MATLAB command prompt: Enter `nftool`.

## Examples

- “Fit Data with a Shallow Neural Network”

## See Also

### Apps

[Neural Net Time Series](#) | [Neural Net Clustering](#) | [Neural Net Pattern Recognition](#)

### Functions

`feedforwardnet` | `fitnet` | `trainbr` | `trainlm` | `trainscg`

### Topics

“Fit Data with a Shallow Neural Network”

# Neural Net Clustering

Cluster data by training a self-organizing maps network

## Description

The **Neural Net Clustering** app leads you through solving a clustering problem using a self-organizing map (SOM). It helps you select data, define the network architecture, and train the network. You can select your own data from the MATLAB workspace or use one of the example datasets. After training the network, analyze the results using various visualization tools. You can then evaluate the performance of the network on a test set. If you are not satisfied with the results, you can retrain the network with modified settings or on a larger data set.

You can generate MATLAB scripts to reproduce results or customize the training process. You can also save the trained network to test on new data or use for solving similar clustering problems. The app also provides the option to generate various deployable versions of your trained network. For example, you can deploy the trained network using MATLAB Compiler, MATLAB Coder, or Simulink Coder tools.

## Required Products

- MATLAB
- Deep Learning Toolbox

## Open the Neural Net Clustering App

- MATLAB Toolstrip: On the **Apps** tab, under **Machine Learning**, click the app icon.
- MATLAB command prompt: Enter `nctool`.

## Examples

- “Cluster Data with a Self-Organizing Map”

## See Also

### Apps

[Neural Net Fitting](#) | [Neural Net Pattern Recognition](#) | [Neural Net Time Series](#)

### Functions

[learnsomb](#) | [selforgmap](#) | [trainbu](#)

### Topics

“Cluster Data with a Self-Organizing Map”

# Neural Net Pattern Recognition

Classify data by training a two-layer feed-forward network

## Description

The **Neural Net Pattern Recognition** app leads you through solving a data classification problem using a two-layer feed-forward network. It helps you select data, divide it into training, validation, and testing sets, define the network architecture, and train the network. You can select your own data from the MATLAB workspace or use one of the example datasets. After training the network, evaluate its performance using cross-entropy and percent misclassification error. Further analyze the results using visualization tools such as confusion matrices and receiver operating characteristic curves. You can then evaluate the performance of the network on a test set. If you are not satisfied with the results, you can retrain the network with modified settings or on a larger data set.

You can generate MATLAB scripts to reproduce results or customize the training process. You can also save the trained network to test on new data or use for solving similar classification problems. The app also provides the option to generate various deployable versions of your trained network. For example, you can deploy the trained network using MATLAB Compiler, MATLAB Coder, or Simulink Coder tools.

## Required Products

- MATLAB
- Deep Learning Toolbox

## Open the Neural Net Pattern Recognition App

- MATLAB Toolstrip: On the **Apps** tab, under **Machine Learning**, click the app icon.
- MATLAB command prompt: Enter `nprtool`.

## Examples

- “Classify Patterns with a Shallow Neural Network”

## See Also

### Apps

[Neural Net Fitting](#) | [Neural Net Clustering](#) | [Neural Net Time Series](#)

### Functions

`patternnet` | `trainlm`

### Topics

“Classify Patterns with a Shallow Neural Network”

# Neural Net Time Series

Solve a nonlinear time series problem by training a dynamic neural network

## Description

The **Neural Net Time Series** app leads you through solving three different kinds of nonlinear time series problems using a dynamic network. It helps you select data, divide it into training, validation, and testing sets, define the network architecture, and train the network. You can select your own data from the MATLAB workspace or use one of the example datasets. After training the network, evaluate its performance using mean squared error and regression analysis. Further analyze the results using visualization tools such as an error autocorrelation plot or histogram of the errors. You can then evaluate the performance of the network on a test set. If you are not satisfied with the results, retrain the network with modified settings or on a larger data set.

You can generate MATLAB scripts to reproduce results or customize the training process. You can also save the trained network to test on new data or use for solving similar classification problems. The app also provides the option to generate various deployable versions of your trained network. For example, you can deploy the trained network using MATLAB Compiler, MATLAB Coder, or Simulink Coder tools.

## Required Products

- MATLAB
- Deep Learning Toolbox

## Open the Neural Net Time Series App

- MATLAB Toolstrip: On the **Apps** tab, under **Machine Learning**, click the app icon.
- MATLAB command prompt: Enter `ntstool`.

## Examples

- “Shallow Neural Network Time-Series Prediction and Modeling”

## See Also

### Apps

[Neural Net Fitting](#) | [Neural Net Clustering](#) | [Neural Net Pattern Recognition](#)

### Functions

[narnet](#) | [narxnet](#)

### Topics

“Shallow Neural Network Time-Series Prediction and Modeling”

## matlab.io.datastore.MiniBatchable class

**Package:** matlab.io.datastore

Add mini-batch support to datastore

### Description

matlab.io.datastore.MiniBatchable is an abstract mixin class that adds support for mini-batches to your custom datastore for use with Deep Learning Toolbox. A mini-batch datastore contains training and test data sets for use in Deep Learning Toolbox training, prediction, and classification.

To use this mixin class, you must inherit from the matlab.io.datastore.MiniBatchable class in addition to inheriting from the matlab.io.Datastore base class. Type the following syntax as the first line of your class definition file:

```
classdef MyDatastore < matlab.io.Datastore & ...
    matlab.io.datastore.MiniBatchable
    ...
end
```

To add support for mini-batches to your datastore:

- Inherit from an additional class matlab.io.datastore.MiniBatchable
- Define two additional properties: MiniBatchSize and NumObservations.

For more details and steps to create your custom mini-batch datastore to optimize performance during training, prediction, and classification, see “Develop Custom Mini-Batch Datastore”.

### Properties

#### MiniBatchSize — Number of observations in each batch

positive integer

Number of observations that are returned in each batch, or call of the read function. For training, prediction, and classification, the MiniBatchSize property is set to the mini-batch size defined in trainingOptions.

#### Attributes:

Abstract	true
Access	Public

#### NumObservations — Total number of observations in the datastore

positive integer

Total number of observations contained within the datastore. This number of observations is the length of one training epoch.

#### Attributes:

Abstract	true
SetAccess	Protected
ReadAccess	Public

## Attributes

Abstract	true
Sealed	false

For information on class attributes, see “Class Attributes” (MATLAB).

## Copy Semantics

Handle. To learn how handle classes affect copy operations, see Copying Objects (MATLAB).

## Examples

### Train Network Using Out-of-Memory Sequence Data

This example shows how to train a deep learning network on out-of-memory sequence data by transforming and combining datastores.

A transformed datastore transforms or processes data read from an underlying datastore. You can use a transformed datastore as a source of training, validation, test, and prediction data sets for deep learning applications. Use transformed datastores to read out-of-memory data or to perform specific preprocessing operations when reading batches of data. When you have separate datastores containing predictors and labels, you can combine them so you can input the data into a deep learning network.

When training the network, the software creates mini-batches of sequences of the same length by padding, truncating, or splitting the input data. For in-memory data, the `trainingOptions` function provides options to pad and truncate input sequences, however, for out-of-memory data, you must pad and truncate the sequences manually.

### Load Training Data

Load the Japanese Vowels data set as described in [1] and [2]. The zip file `japaneseVowels.zip` contains sequences of varying length. The sequences are divided into two folders, `Train` and `Test`, which contain training sequences and test sequences, respectively. In each of these folders, the sequences are divided into subfolders, which are numbered from 1 to 9. The names of these subfolders are the label names. A MAT file represents each sequence. Each sequence is a matrix with 12 rows, with one row for each feature, and a varying number of columns, with one column for each time step. The number of rows is the sequence dimension and the number of columns is the sequence length.

Unzip the sequence data.

```
filename = "japaneseVowels.zip";
outputFolder = fullfile(tempdir,"japaneseVowels");
unzip(filename,outputFolder);
```

For the training predictors, create a file datastore and specify the read function to be the `load` function. The `load` function, loads the data from the MAT-file into a structure array. To read files from the subfolders in the training folder, set the `'IncludeSubfolders'` option to `true`.

```
folderTrain = fullfile(outputFolder,"Train");
fdsPredictorTrain = fileDatastore(folderTrain, ...
    'ReadFcn',@load, ...
    'IncludeSubfolders',true);
```

Preview the datastore. The returned struct contains a single sequence from the first file.

```
preview(fdsPredictorTrain)

ans = struct with fields:
    X: [12×20 double]
```

For the labels, create a file datastore and specify the read function to be the `readLabel` function, defined at the end of the example. The `readLabel` function extracts the label from the subfolder name.

```
classNames = string(1:9);
fdsLabelTrain = fileDatastore(folderTrain, ...
    'ReadFcn',@(filename) readLabel(filename,classNames), ...
    'IncludeSubfolders',true);
```

Preview the datastore. The output corresponds to the label of the first file.

```
preview(fdsLabelTrain)

ans = categorical
     1
```

### Transform and Combine Datastores

To input the sequence data from the datastore of predictors to a deep learning network, the mini-batches of the sequences must have the same length. Transform the datastore using the `padSequence` function, defined at the end of the datastore, that pads or truncates the sequences to have length 20.

```
sequenceLength = 20;
tdsTrain = transform(fdsPredictorTrain,@(data) padSequence(data,sequenceLength));
```

Preview the transformed datastore. The output corresponds to the padded sequence from the first file.

```
X = preview(tdsTrain)

X = 1×1 cell array
    {12×20 double}
```

To input both the predictors and labels from both datastores into a deep learning network, combine them using the `combine` function.

```
cdsTrain = combine(tdsTrain,fdsLabelTrain);
```



Preview the combined datastore. The datastore returns a 1-by-2 cell array. The first element corresponds to the predictors. The second element corresponds to the label.

```
preview(cdsTrain)

ans = 1x2 cell array
      {12x20 double}    {[1]}
```

### Define LSTM Network Architecture

Define the LSTM network architecture. Specify the number of features of the input data as the input size. Specify an LSTM layer with 100 hidden units and to output the last element of the sequence. Finally, specify a fully connected layer with output size equal to the number of classes, followed by a softmax layer and a classification layer.

```
numFeatures = 12;
numClasses = numel(classNames);
numHiddenUnits = 100;

layers = [ ...
    sequenceInputLayer(numFeatures)
    lstmLayer(numHiddenUnits,'OutputMode','last')
    fullyConnectedLayer(numClasses)
    softmaxLayer
    classificationLayer];
```

Specify the training options. Set the solver to 'adam' and 'GradientThreshold' to 2. Set the mini-batch size to 27 and set the maximum number of epochs to 75. The datastores do not support shuffling, so set 'Shuffle' to 'never'.

Because the mini-batches are small with short sequences, the CPU is better suited for training. Set 'ExecutionEnvironment' to 'cpu'. To train on a GPU, if available, set 'ExecutionEnvironment' to 'auto' (the default value).

```
miniBatchSize = 27;

options = trainingOptions('adam', ...
    'ExecutionEnvironment','cpu', ...
    'MaxEpochs',75, ...
    'MiniBatchSize',miniBatchSize, ...
    'GradientThreshold',2, ...
    'Shuffle','never',...
    'Verbose',0, ...
    'Plots','training-progress');
```

Train the LSTM network with the specified training options.

```
net = trainNetwork(cdsTrain,layers,options);
```



## Test the Network

Create a transformed datastore containing the held-out test data using the same steps as for the training data.

```
folderTest = fullfile(outputFolder, "Test");

fdsPredictorTest = fileDatastore(folderTest, ...
    'ReadFcn', @load, ...
    'IncludeSubfolders', true);
tdsTest = transform(fdsPredictorTest, @(data) padSequence(data, sequenceLength));
```

Make predictions on the test data using the trained network.

```
YPred = classify(net, tdsTest, 'MiniBatchSize', miniBatchSize);
```

Calculate the classification accuracy on the test data. To get the labels of the test set, create a file datastore with the read function `readLabel` and specify to include subfolders. Specify that the outputs are vertically concatenateable by setting the `'UniformRead'` option to `true`.

```
fdsLabelTest = fileDatastore(folderTest, ...
    'ReadFcn', @(filename) readLabel(filename, classNames), ...
    'IncludeSubfolders', true, ...
    'UniformRead', true);
YTest = readall(fdsLabelTest);

accuracy = mean(YPred == YTest)

accuracy = 0.9351
```

## Functions

The `readLabel` function extracts the label from the specified filename over the categories in `classNames`.

```
function label = readLabel(filename,classNames)

filepath = fileparts(filename);
[~,label] = fileparts(filepath);

label = categorical(string(label),classNames);

end
```

The `padSequence` function pads or truncates the sequence in `data.X` to have the specified sequence length and returns the result in a 1-by-1 cell.

```
function sequence = padSequence(data,sequenceLength)

sequence = data.X;
[C,S] = size(sequence);

if S < sequenceLength
    padding = zeros(C,sequenceLength-S);
    sequence = [sequence padding];
else
    sequence = sequence(:,1:sequenceLength);
end

sequence = {sequence};

end
```

## Compatibility Considerations

### **matlab.io.datastore.MiniBatchable is not recommended for custom image preprocessing**

*Not recommended starting in R2019a*

Starting in R2019a, `matlab.io.datastore.MiniBatchable` is not recommended for custom image processing. Use the `transform` and `combine` functions with built-in datastores instead. For more information, see “Preprocess Images for Deep Learning”.

## References

- [1] Kudo, M., J. Toyama, and M. Shimbo. "Multidimensional Curve Classification Using Passing-Through Regions." *Pattern Recognition Letters*. Vol. 20, No. 11-13, pp. 1103-1111.
- [2] Kudo, M., J. Toyama, and M. Shimbo. *Japanese Vowels Data Set*. <https://archive.ics.uci.edu/ml/datasets/Japanese+Vowels>

## See Also

`matlab.io.Datastore` | `matlab.io.datastore.Partitionable` | `matlab.io.datastore.Shuffleable` | `read`

**Topics**

“Deep Learning in MATLAB”

“Develop Custom Mini-Batch Datastore”

**Introduced in R2018a**

# read

**Class:** `matlab.io.datastore.MiniBatchable`

**Package:** `matlab.io.datastore`

Read data from mini-batch datastore

---

**Note** The `read` method of `matlab.io.datastore.MiniBatchable` is not recommended. For more information, see [Compatibility Considerations](#).

---

## Syntax

```
data = read(ds)
[data,info] = read(ds)
```

## Description

`data = read(ds)` returns data from a mini-batch datastore. Subsequent calls to the `read` function continue reading from the endpoint of the previous call.

`[data,info] = read(ds)` also returns information about the extracted data in `info`, including metadata.

## Input Arguments

**mbds — Mini-batch datastore**

`datastore` | `custom MiniBatchable datastore` | ...

Mini-batch datastore, specified as a built-in datastore or custom mini-batch datastore. For more information, see “Datastores for Deep Learning”.

## Output Arguments

**data — Output data**

`table`

Output data, returned as a table with `MiniBatchSize` number of rows. For the last mini-batch of data in the datastore, if `NumObservations` is not evenly divisible by `MiniBatchSize`, then `data` should contain the remaining observations in the datastore (a partial batch smaller than `MiniBatchSize`).

The table should have two columns, with predictors in the first column and responses in the second column.

**info — Information about read data**

`structure array`

Information about read data, returned as a structure array.

## Attributes

Hidden true

To learn about attributes of methods, see Method Attributes (MATLAB).

## Compatibility Considerations

### **read is not recommended**

*Not recommended starting in R2019a*

Before R2018a, to perform custom image preprocessing for training deep learning networks, you had to specify a custom read function using the `readFcn` property of `imageDatastore`. However, reading files using a custom read function was slow because `imageDatastore` did not prefetch files.

In R2018a, four classes including `matlab.io.datastore.MiniBatchable` were introduced as a solution to perform custom image preprocessing with support for prefetching, shuffling, and parallel training. Implementing a custom mini-batch datastore using `matlab.io.datastore.MiniBatchable` has several challenges and limitations.

- In addition to specifying the preprocessing operations, you must also define properties and methods to support reading data in batches, reading data by index, and partitioning and shuffling data.
- You must specify a value for the `NumObservations` property, but this value may be ill-defined or difficult to define in real-world applications.
- Custom mini-batch datastores are not flexible enough to support common deep learning workflows, such as deployed workflows using GPU Coder.

Starting in R2019a, built-in datastores natively support prefetch, shuffling, and parallel training when reading batches of data. The `transform` function is the preferred way to perform custom data preprocessing, or transformations. The `combine` function is the preferred way to concatenate read data from multiple datastores, including transformed datastores. Concatenated data can serve as the network inputs and expected responses for training deep learning networks. The `transform` and `combine` functions have several advantages over `matlab.io.datastore.MiniBatchable`.

- The functions enable data preprocessing and concatenation for all types of datastores, including `imageDatastore`.
- The `transform` function only requires you to define the data processing pipeline.
- When used on a deterministic datastore, the functions support tall data types and MapReduce.
- The functions support deployed workflows.

---

**Note** The recommended solution to transform data with basic image preprocessing operations, including resizing, rotation, and reflection, is `augmentedImageDatastore`. For more information, see “Preprocess Images for Deep Learning”.

---

There are no plans to remove the `read` method of `matlab.io.datastore.MiniBatchable` at this time.

**See Also**

[combine](#) | [matlab.io.Datastore](#) | [matlab.io.datastore.Minibatchable](#) | [read \(Datastore\)](#) | [transform](#)

**Topics**

[“Datastores for Deep Learning”](#)  
[“Preprocess Images for Deep Learning”](#)  
[“Deep Learning in MATLAB”](#)

**Introduced in R2018a**

## matlab.io.datastore.BackgroundDispatchable class

**Package:** matlab.io.datastore

(Not recommended) Add prefetch reading support to datastore

---

**Note** matlab.io.datastore.BackgroundDispatchable is not recommended. For more information, see Compatibility Considerations.

---

### Description

matlab.io.datastore.BackgroundDispatchable is an abstract mixin class that adds support for prefetch reading to your custom datastore for use with Deep Learning Toolbox.

To use this mixin class, you must inherit from the matlab.io.datastore.BackgroundDispatchable class in addition to inheriting from the matlab.io.Datastore base class. Type the following syntax as the first line of your class definition file:

```
classdef MyDatastore < matlab.io.Datastore & ...  
    matlab.io.datastore.BackgroundDispatchable  
    ...  
end
```

To add support for parallel processing to your custom datastore, you must:

- Inherit from an additional class matlab.io.datastore.BackgroundDispatchable
- Define the additional method: readByIndex

For more details and steps to create your custom datastore to optimize performance during training, prediction, and classification, see “Develop Custom Mini-Batch Datastore”.

### Properties

#### DispatchInBackground — Dispatch observations in background

true (default) | false

Dispatch observations in the background during training, prediction, or classification, specified as true or false. To use background dispatching, you must have Parallel Computing Toolbox.

#### Attributes:

Public true

### Methods

readByIndex (Not recommended) Return observations from a datastore specified by index



## Attributes

Abstract	true
Sealed	false

For information on class attributes, see “Class Attributes” (MATLAB).

## Copy Semantics

Handle. To learn how handle classes affect copy operations, see Copying Objects (MATLAB).

## Compatibility Considerations

### **matlab.io.datastore.BackgroundDispatchable is not recommended**

*Not recommended starting in R2019a*

Before R2018a, to perform custom image preprocessing for training deep learning networks, you had to specify a custom read function using the `readFcn` property of `imageDatastore`. However, reading files using a custom read function was slow because `imageDatastore` did not prefetch files.

In R2018a, four classes including `matlab.io.datastore.Minibatchable` and `matlab.io.datastore.BackgroundDispatchable` were introduced as a solution to perform custom image preprocessing with support for prefetching, shuffling, and parallel training. Implementing a custom mini-batch datastore using `matlab.io.datastore.Minibatchable` has several challenges and limitations.

- In addition to specifying the preprocessing operations, you must also define properties and methods to support reading data in batches, reading data by index, and partitioning and shuffling data.
- You must specify a value for the `NumObservations` property, but this value may be ill-defined or difficult to define in real-world applications.
- Custom mini-batch datastores are not flexible enough to support common deep learning workflows, such as deployed workflows using GPU Coder.

Starting in R2019a, datastores natively support prefetch, shuffling, and parallel training when reading batches of data. The `transform` function is the preferred way to perform custom data preprocessing, or transformations. The `combine` function is the preferred way to concatenate read data from multiple datastores, including transformed datastores. Concatenated data can serve as the network inputs and expected responses for training deep learning networks. The `transform` and `combine` functions have several advantages over `matlab.io.datastore.Minibatchable` and `matlab.io.datastore.BackgroundDispatchable`.

- The functions enable data preprocessing and concatenation for all types of datastores, including `imageDatastore`.
- The `transform` function only requires you to define the data processing pipeline.
- When used on a deterministic datastore, the functions support tall data types and MapReduce.
- The functions support deployed workflows.

---

**Note** The recommended solution to transform data with basic image preprocessing operations, including resizing, rotation, and reflection, is `augmentedImageDatastore`. For more information, see “Preprocess Images for Deep Learning”.

---

There are no plans to remove `matlab.io.datastore.BackgroundDispatchable` at this time.

### See Also

`combine` | `matlab.io.Datastore` | `matlab.io.datastore.Partitionable` |  
`matlab.io.datastore.Shuffleable` | `transform`

### Topics

“Preprocess Images for Deep Learning”  
“Deep Learning in MATLAB”

**Introduced in R2018a**

# readByIndex

**Class:** matlab.io.datastore.BackgroundDispatchable

**Package:** matlab.io.datastore

(Not recommended) Return observations from a datastore specified by index

---

**Note** readByIndex is not recommended. For more information, see Compatibility Considerations.

---

## Syntax

```
[data,info] = readByIndex(ds,ind)
```

## Description

[data,info] = readByIndex(ds,ind) returns a subset of observations in a datastore, ds. The desired observations are specified by indices, ind.

## Input Arguments

### ds — Input datastore

Datastore object

Input datastore, specified as a Datastore object.

### ind — Indices

vector of positive integers

Indices of observations, specified as a vector of positive integers.

## Output Arguments

### data — Observations from datastore

table

Observations from the datastore, returned as a table or an array according to the read method of the datastore. For example, when ds is a custom mini-batch datastore, then data is a table with the same format as returned by the read (MiniBatchable) method.

### info — Information about read data

structure array

Information about read data, returned as a structure array. The structure array can contain the following fields.

Field Name	Description
Filename	Filename is a fully resolved path containing the path string, name of the file, and file extension.

Field Name	Description
FileSize	Total file size, in bytes. For MAT-files, FileSize is the total number of key-value pairs in the file.

## Attributes

Abstract	true
Access	Public

To learn about attributes of methods, see [Method Attributes \(MATLAB\)](#).

## Tips

- You must implement the `readByIndex` method by deriving a subclass from the `matlab.io.datastore.BackgroundDispatchable` class.

## Compatibility Considerations

### **readByIndex is not recommended**

*Not recommended starting in R2019a*

Before R2018a, to perform custom image preprocessing for training deep learning networks, you had to specify a custom read function using the `readFcn` property of `imageDatastore`. However, reading files using a custom read function was slow because `imageDatastore` did not prefetch files.

In R2018a, four classes including `matlab.io.datastore.Minibatchable` and `matlab.io.datastore.BackgroundDispatchable` were introduced as a solution to perform custom image preprocessing with support for prefetching, shuffling, and parallel training. Implementing a custom mini-batch datastore using `matlab.io.datastore.Minibatchable` has several challenges and limitations.

- In addition to specifying the preprocessing operations, you must also define properties and methods to support reading data in batches, reading data by index, and partitioning and shuffling data.
- You must specify a value for the `NumObservations` property, but this value may be ill-defined or difficult to define in real-world applications.
- Custom mini-batch datastores are not flexible enough to support common deep learning workflows, such as deployed workflows using GPU Coder.

Starting in R2019a, datastores natively support prefetch, shuffling, and parallel training when reading batches of data. The `transform` function is the preferred way to perform custom data preprocessing, or transformations. The `combine` function is the preferred way to concatenate read data from multiple datastores, including transformed datastores. Concatenated data can serve as the network inputs and expected responses for training deep learning networks. The `transform` and `combine` functions have several advantages over `matlab.io.datastore.Minibatchable` and `matlab.io.datastore.BackgroundDispatchable`.

- The functions enable data preprocessing and concatenation for all types of datastores, including `imageDatastore`.

- The `transform` function only requires you to define the data processing pipeline.
- When used on a deterministic datastore, the functions support `all` data types and MapReduce.
- The functions support deployed workflows.

---

**Note** The recommended solution to transform data with basic image preprocessing operations, including resizing, rotation, and reflection, is `augmentedImageDatastore`. For more information, see “Preprocess Images for Deep Learning”.

---

There are no plans to remove `matlab.io.datastore.BackgroundDispatchable` class or the `readByIndex` method at this time.

## See Also

`combine` | `matlab.io.Datastore` | `read` | `readall` | `transform`

## Topics

“Preprocess Images for Deep Learning”  
“Deep Learning in MATLAB”

**Introduced in R2018a**

## matlab.io.datastore.PartitionableByIndex class

**Package:** matlab.io.datastore

(Not recommended) Add parallelization support to datastore

---

**Note** matlab.io.datastore.PartitionableByIndex is not recommended. For more information, see Compatibility Considerations.

---

### Description

matlab.io.datastore.PartitionableByIndex is an abstract mixin class that adds parallelization support to your custom datastore for use with Deep Learning Toolbox. This class requires Parallel Computing Toolbox.

To use this mixin class, you must inherit from the matlab.io.datastore.PartitionableByIndex class in addition to inheriting from the matlab.io.Datastore base class. Type the following syntax as the first line of your class definition file:

```
classdef MyDatastore < matlab.io.Datastore & ...
    matlab.io.datastore.PartitionableByIndex
    ...
end
```

To add support for parallel processing to your custom datastore, you must:

- Inherit from an additional class matlab.io.datastore.PartitionableByIndex
- Define the additional method: partitionByIndex

For more details and steps to create your custom datastore with parallel processing support, see “Develop Custom Mini-Batch Datastore”.

### Methods

partitionByIndex (Not recommended) Partition a datastore according to indices

### Attributes

Abstract	true
Sealed	false

For information on class attributes, see “Class Attributes” (MATLAB).

### Copy Semantics

Handle. To learn how handle classes affect copy operations, see Copying Objects (MATLAB).

## Compatibility Considerations

### **matlab.io.datastore.PartitionableByIndex is not recommended**

*Not recommended starting in R2019a*

Before R2018a, to perform custom image preprocessing for training deep learning networks, you had to specify a custom read function using the `readFcn` property of `imageDatastore`. However, reading files using a custom read function was slow because `imageDatastore` did not prefetch files.

In R2018a, four classes including `matlab.io.datastore.Minibatchable` and `matlab.io.datastore.PartitionableByIndex` were introduced as a solution to perform custom image preprocessing with support for prefetching, shuffling, and parallel training. Implementing a custom mini-batch datastore using `matlab.io.datastore.Minibatchable` has several challenges and limitations.

- In addition to specifying the preprocessing operations, you must also define properties and methods to support reading data in batches, reading data by index, and partitioning and shuffling data.
- You must specify a value for the `NumObservations` property, but this value may be ill-defined or difficult to define in real-world applications.
- Custom mini-batch datastores are not flexible enough to support common deep learning workflows, such as deployed workflows using GPU Coder.

Starting in R2019a, datastores natively support prefetch, shuffling, and parallel training when reading batches of data. The `transform` function is the preferred way to perform custom data preprocessing, or transformations. The `combine` function is the preferred way to concatenate read data from multiple datastores, including transformed datastores. Concatenated data can serve as the network inputs and expected responses for training deep learning networks. The `transform` and `combine` functions have several advantages over `matlab.io.datastore.Minibatchable` and `matlab.io.datastore.PartitionableByIndex`.

- The functions enable data preprocessing and concatenation for all types of datastores, including `imageDatastore`.
- The `transform` function only requires you to define the data processing pipeline.
- When used on a deterministic datastore, the functions support tall data types and MapReduce.
- The functions support deployed workflows.

---

**Note** The recommended solution to transform data with basic image preprocessing operations, including resizing, rotation, and reflection, is `augmentedImageDatastore`. For more information, see “Preprocess Images for Deep Learning”.

---

There are no plans to remove `matlab.io.datastore.PartitionableByIndex` at this time.

### See Also

`combine` | `matlab.io.Datastore` | `matlab.io.datastore.HadoopFileBased` | `matlab.io.datastore.Partitionable` | `matlab.io.datastore.Shuffleable` | `transform`

### Topics

“Preprocess Images for Deep Learning”  
“Deep Learning in MATLAB”

**Introduced in R2018a**



# partitionByIndex

(Not recommended) Partition a datastore according to indices

---

**Note** `partitionByIndex` is not recommended. For more information, see [Compatibility Considerations](#).

---

## Syntax

```
ds2 = partitionByIndex(ds,ind)
```

## Description

`ds2 = partitionByIndex(ds,ind)` partitions a subset of observations in a datastore, `ds`, into a new datastore, `ds2`. The desired observations are specified by indices, `ind`.

## Input Arguments

### **ds** — Input datastore

Datastore object

Input datastore, specified as a Datastore object.

### **ind** — Indices

vector of positive integers

Indices of observations, specified as a vector of positive integers.

## Output Arguments

### **ds2** — Partitioned datastore

Datastore object

Partitioned datastore, returned as a Datastore object.

## Attributes

Abstract	true
Access	Public

To learn about attributes of methods, see [Method Attributes \(MATLAB\)](#).

## Tips

- You must implement the `partitionByIndex` method by deriving a subclass from the `matlab.io.datastore.Partitionable` class.

## Compatibility Considerations

### **partitionByIndex is not recommended**

*Not recommended starting in R2019a*

Before R2018a, to perform custom image preprocessing for training deep learning networks, you had to specify a custom read function using the `readFcn` property of `imageDatastore`. However, reading files using a custom read function was slow because `imageDatastore` did not prefetch files.

In R2018a, four classes including `matlab.io.datastore.MiniBatchable` and `matlab.io.datastore.PartitionableByIndex` were introduced as a solution to perform custom image preprocessing with support for prefetching, shuffling, and parallel training. Implementing a custom mini-batch datastore using `matlab.io.datastore.MiniBatchable` has several challenges and limitations.

- In addition to specifying the preprocessing operations, you must also define properties and methods to support reading data in batches, reading data by index, and partitioning and shuffling data.
- You must specify a value for the `NumObservations` property, but this value may be ill-defined or difficult to define in real-world applications.
- Custom mini-batch datastores are not flexible enough to support common deep learning workflows, such as deployed workflows using GPU Coder.

Starting in R2019a, datastores natively support prefetch, shuffling, and parallel training when reading batches of data. The `transform` function is the preferred way to perform custom data preprocessing, or transformations. The `combine` function is the preferred way to concatenate read data from multiple datastores, including transformed datastores. Concatenated data can serve as the network inputs and expected responses for training deep learning networks. The `transform` and `combine` functions have several advantages over `matlab.io.datastore.MiniBatchable` and `matlab.io.datastore.PartitionableByIndex`.

- The functions enable data preprocessing and concatenation for all types of datastores, including `imageDatastore`.
- The `transform` function only requires you to define the data processing pipeline.
- When used on a deterministic datastore, the functions support tall data types and MapReduce.
- The functions support deployed workflows.

---

**Note** The recommended solution to transform data with basic image preprocessing operations, including resizing, rotation, and reflection, is `augmentedImageDatastore`. For more information, see “Preprocess Images for Deep Learning”.

---

There are no plans to remove `partitionByIndex` at this time.

### **See Also**

`combine` | `matlab.io.Datastore` | `transform`

### **Topics**

“Preprocess Images for Deep Learning”  
“Deep Learning in MATLAB”

**Introduced in R2018a**

## trainAutoencoder

Train an autoencoder

### Syntax

```
autoenc = trainAutoencoder(X)
autoenc = trainAutoencoder(X,hiddenSize)
autoenc = trainAutoencoder( ____,Name,Value)
```

### Description

`autoenc = trainAutoencoder(X)` returns an autoencoder, `autoenc`, trained using the training data in `X`.

`autoenc = trainAutoencoder(X,hiddenSize)` returns an autoencoder `autoenc`, with the hidden representation size of `hiddenSize`.

`autoenc = trainAutoencoder( ____,Name,Value)` returns an autoencoder `autoenc`, for any of the above input arguments with additional options specified by one or more `Name,Value` pair arguments.

For example, you can specify the sparsity proportion or the maximum number of training iterations.

### Examples

#### Train Sparse Autoencoder

Load the sample data.

```
X = abalone_dataset;
```

`X` is an 8-by-4177 matrix defining eight attributes for 4177 different abalone shells: sex (M, F, and I (for infant)), length, diameter, height, whole weight, shucked weight, viscera weight, shell weight. For more information on the dataset, type `help abalone_dataset` in the command line.

Train a sparse autoencoder with default settings.

```
autoenc = trainAutoencoder(X);
```

Reconstruct the abalone shell ring data using the trained autoencoder.

```
XReconstructed = predict(autoenc,X);
```

Compute the mean squared reconstruction error.

```
mseError = mse(X-XReconstructed)
```

```
mseError = 0.0167
```

## Train Autoencoder with Specified Options

Load the sample data.

```
X = abalone_dataset;
```

X is an 8-by-4177 matrix defining eight attributes for 4177 different abalone shells: sex (M, F, and I (for infant)), length, diameter, height, whole weight, shucked weight, viscera weight, shell weight. For more information on the dataset, type `help abalone_dataset` in the command line.

Train a sparse autoencoder with hidden size 4, 400 maximum epochs, and linear transfer function for the decoder.

```
autoenc = trainAutoencoder(X,4,'MaxEpochs',400,...
    'DecoderTransferFunction','purelin');
```

Reconstruct the abalone shell ring data using the trained autoencoder.

```
XReconstructed = predict(autoenc,X);
```

Compute the mean squared reconstruction error.

```
mseError = mse(X-XReconstructed)
```

```
mseError = 0.0046
```

## Reconstruct Observations Using Sparse Autoencoder

Generate the training data.

```
rng(0,'twister'); % For reproducibility
n = 1000;
r = linspace(-10,10,n)';
x = 1 + r*5e-2 + sin(r)./r + 0.2*randn(n,1);
```

Train autoencoder using the training data.

```
hiddenSize = 25;
autoenc = trainAutoencoder(x',hiddenSize,...
    'EncoderTransferFunction','satlin',...
    'DecoderTransferFunction','purelin',...
    'L2WeightRegularization',0.01,...
    'SparsityRegularization',4,...
    'SparsityProportion',0.10);
```

Generate the test data.

```
n = 1000;
r = sort(-10 + 20*rand(n,1));
xtest = 1 + r*5e-2 + sin(r)./r + 0.4*randn(n,1);
```

Predict the test data using the trained autoencoder, `autoenc`.

```
xReconstructed = predict(autoenc,xtest');
```

Plot the actual test data and the predictions.

```
figure;  
plot(xtest,'r.');
```

```
hold on  
plot(xReconstructed,'go');
```

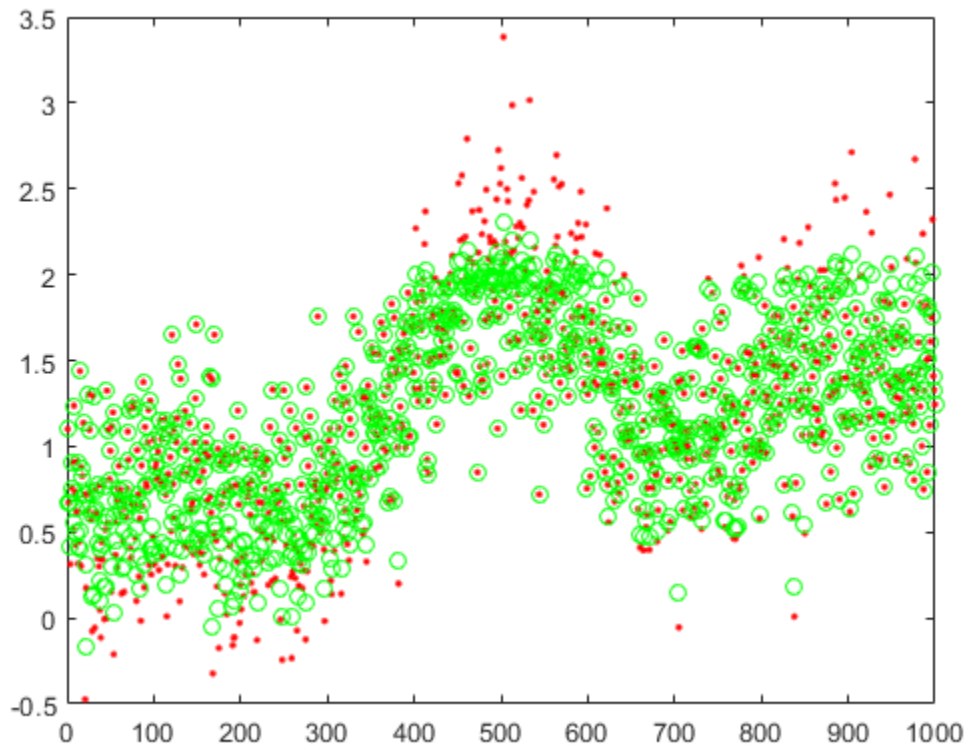

### Reconstruct Handwritten Digit Images Using Sparse Autoencoder

Load the training data.

```
XTrain = digitTrainCellArrayData;
```

The training data is a 1-by-5000 cell array, where each cell containing a 28-by-28 matrix representing a synthetic image of a handwritten digit.

Train an autoencoder with a hidden layer containing 25 neurons.

```
hiddenSize = 25;  
autoenc = trainAutoencoder(XTrain,hiddenSize,...  
    'L2WeightRegularization',0.004,...  
    'SparsityRegularization',4,...  
    'SparsityProportion',0.15);
```

Load the test data.

```
XTest = digitTestCellArrayData;
```

The test data is a 1-by-5000 cell array, with each cell containing a 28-by-28 matrix representing a synthetic image of a handwritten digit.

Reconstruct the test image data using the trained autoencoder, `autoenc`.

```
xReconstructed = predict(autoenc,XTest);
```

View the actual test data.

```
figure;  
for i = 1:20  
    subplot(4,5,i);  
    imshow(XTest{i});  
end
```

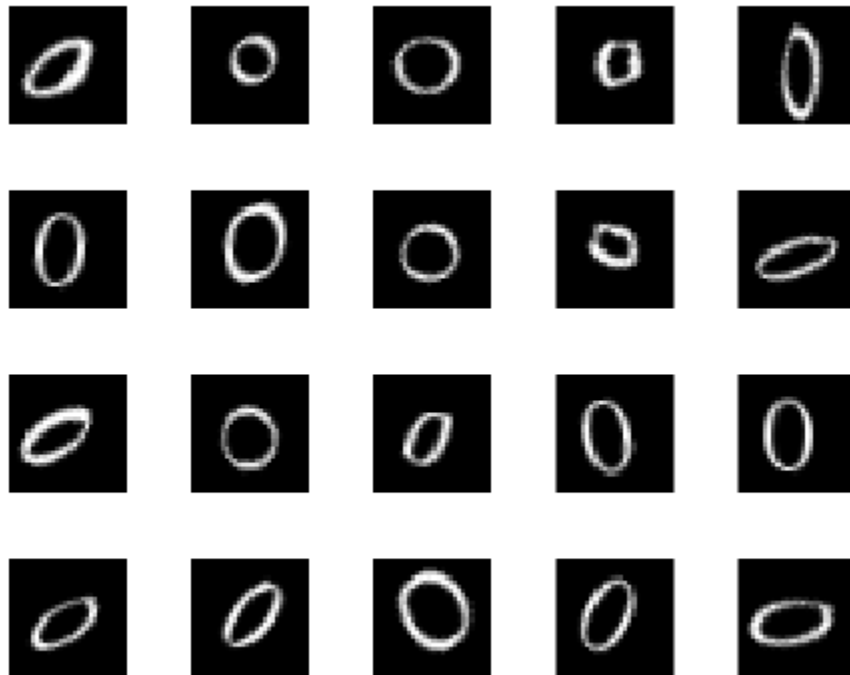

View the reconstructed test data.

```
figure;  
for i = 1:20  
    subplot(4,5,i);  
    imshow(xReconstructed{i});  
end
```

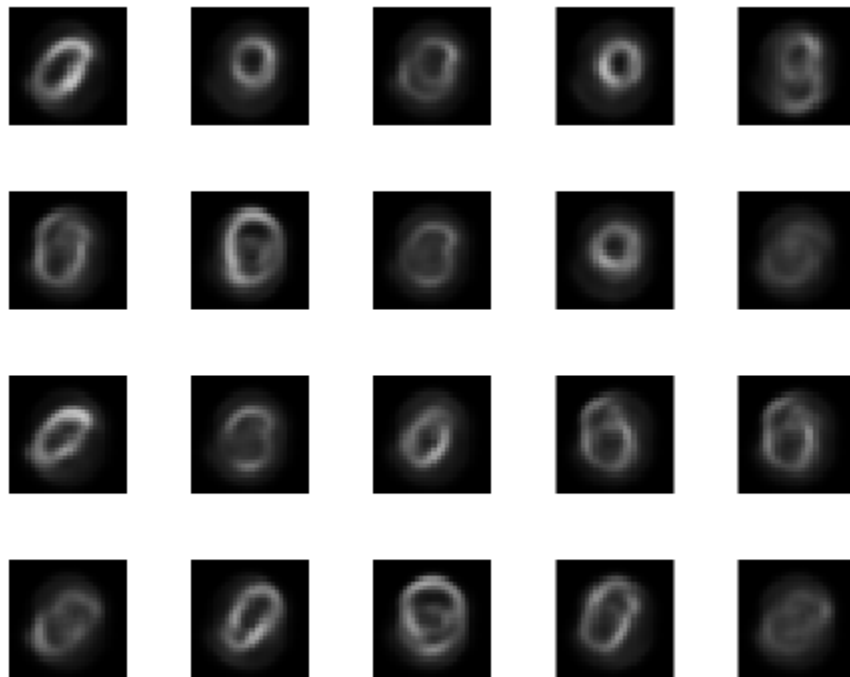

## Input Arguments

### **X** — Training data

matrix | cell array of image data

Training data, specified as a matrix of training samples or a cell array of image data. If **X** is a matrix, then each column contains a single sample. If **X** is a cell array of image data, then the data in each cell must have the same number of dimensions. The image data can be pixel intensity data for gray images, in which case, each cell contains an  $m$ -by- $n$  matrix. Alternatively, the image data can be RGB data, in which case, each cell contains an  $m$ -by- $n$ -3 matrix.

Data Types: `single` | `double` | `cell`

### **hiddenSize** — Size of hidden representation of the autoencoder

10 (default) | positive integer value

Size of hidden representation of the autoencoder, specified as a positive integer value. This number is the number of neurons in the hidden layer.

Data Types: `single` | `double`

### **Name-Value Pair Arguments**

Specify optional comma-separated pairs of **Name**, **Value** arguments. **Name** is the argument name and **Value** is the corresponding value. **Name** must appear inside quotes. You can specify several name and value pair arguments in any order as **Name1**, **Value1**, ..., **NameN**, **ValueN**.



Example: 'EncoderTransferFunction', 'satlin', 'L2WeightRegularization', 0.05 specifies the transfer function for the encoder as the positive saturating linear transfer function and the L2 weight regularization as 0.05.

### EncoderTransferFunction — Transfer function for the encoder

'logsig' (default) | 'satlin'

Transfer function for the encoder, specified as the comma-separated pair consisting of 'EncoderTransferFunction' and one of the following.

Transfer Function Option	Definition
'logsig'	Logistic sigmoid function $f(z) = \frac{1}{1 + e^{-z}}$
'satlin'	Positive saturating linear transfer function $f(z) = \begin{cases} 0, & \text{if } z \leq 0 \\ z, & \text{if } 0 < z < 1 \\ 1, & \text{if } z \geq 1 \end{cases}$

Example: 'EncoderTransferFunction', 'satlin'

### DecoderTransferFunction — Transfer function for the decoder

'logsig' (default) | 'satlin' | 'purelin'

Transfer function for the decoder, specified as the comma-separated pair consisting of 'DecoderTransferFunction' and one of the following.

Transfer Function Option	Definition
'logsig'	Logistic sigmoid function $f(z) = \frac{1}{1 + e^{-z}}$
'satlin'	Positive saturating linear transfer function $f(z) = \begin{cases} 0, & \text{if } z \leq 0 \\ z, & \text{if } 0 < z < 1 \\ 1, & \text{if } z \geq 1 \end{cases}$
'purelin'	Linear transfer function $f(z) = z$

Example: 'DecoderTransferFunction', 'purelin'

### MaxEpochs — Maximum number of training epochs

1000 (default) | positive integer value

Maximum number of training epochs or iterations, specified as the comma-separated pair consisting of 'MaxEpochs' and a positive integer value.

Example: 'MaxEpochs', 1200

**L2WeightRegularization — The coefficient for the  $L_2$  weight regularizer**

0.001 (default) | a positive scalar value

The coefficient for the  $L_2$  weight regularizer on page 2-484 in the cost function (`LossFunction`), specified as the comma-separated pair consisting of '`L2WeightRegularization`' and a positive scalar value.

Example: '`L2WeightRegularization`', 0.05

**LossFunction — Loss function to use for training**

'msesparseness' (default)

Loss function to use for training, specified as the comma-separated pair consisting of '`LossFunction`' and '`msesparseness`'. It corresponds to the mean squared error function adjusted for training a sparse autoencoder on page 2-484 as follows:

$$E = \frac{1}{N} \sum_{n=1}^N \sum_{k=1}^K (x_{kn} - \hat{x}_{kn})^2 + \lambda * \underbrace{\rho_{L_2}^{\text{weights}}}_{\text{regularization}} + \beta * \underbrace{\rho_{\text{sparsity}}^{\text{sparsity}}}_{\text{regularization}},$$

where  $\lambda$  is the coefficient for the  $L_2$  regularization term on page 2-484 and  $\beta$  is the coefficient for the sparsity regularization term on page 2-484. You can specify the values of  $\lambda$  and  $\beta$  by using the `L2WeightRegularization` and `SparsityRegularization` name-value pair arguments, respectively, while training an autoencoder.

**ShowProgressWindow — Indicator to show the training window**

true (default) | false

Indicator to show the training window, specified as the comma-separated pair consisting of '`ShowProgressWindow`' and either true or false.

Example: '`ShowProgressWindow`', false

**SparsityProportion — Desired proportion of training examples a neuron reacts to**

0.05 (default) | positive scalar value in the range from 0 to 1

Desired proportion of training examples a neuron reacts to, specified as the comma-separated pair consisting of '`SparsityProportion`' and a positive scalar value. Sparsity proportion is a parameter of the sparsity regularizer. It controls the sparsity of the output from the hidden layer. A low value for `SparsityProportion` usually leads to each neuron in the hidden layer "specializing" by only giving a high output for a small number of training examples. Hence, a low sparsity proportion encourages higher degree of sparsity. See Sparse Autoencoders on page 2-484.

Example: '`SparsityProportion`', 0.01 is equivalent to saying that each neuron in the hidden layer should have an average output of 0.1 over the training examples.

**SparsityRegularization — Coefficient that controls the impact of the sparsity regularizer**

1 (default) | a positive scalar value

Coefficient that controls the impact of the sparsity regularizer on page 2-484 in the cost function, specified as the comma-separated pair consisting of '`SparsityRegularization`' and a positive scalar value.

Example: '`SparsityRegularization`', 1.6

**TrainingAlgorithm — The algorithm to use for training the autoencoder**`'trainscg'` (default)

The algorithm to use for training the autoencoder, specified as the comma-separated pair consisting of `'TrainingAlgorithm'` and `'trainscg'`. It stands for scaled conjugate gradient descent [1].

**ScaleData — Indicator to rescale the input data**`true` (default) | `false`

Indicator to rescale the input data, specified as the comma-separated pair consisting of `'ScaleData'` and either `true` or `false`.

Autoencoders attempt to replicate their input at their output. For it to be possible, the range of the input data must match the range of the transfer function for the decoder. `trainAutoencoder` automatically scales the training data to this range when training an autoencoder. If the data was scaled while training an autoencoder, the `predict`, `encode`, and `decode` methods also scale the data.

Example: `'ScaleData', false`

**UseGPU — Indicator to use GPU for training**`false` (default) | `true`

Indicator to use GPU for training, specified as the comma-separated pair consisting of `'UseGPU'` and either `true` or `false`.

Example: `'UseGPU', true`

**Output Arguments****autoenc — Trained autoencoder**

Autoencoder object

Trained autoencoder, returned as an `Autoencoder` object. For information on the properties and methods of this object, see `Autoencoder` class page.

**More About****Autoencoders**

An autoencoder is a neural network which is trained to replicate its input at its output. Autoencoders can be used as tools to learn deep neural networks. Training an autoencoder is unsupervised in the sense that no labeled data is needed. The training process is still based on the optimization of a cost function. The cost function measures the error between the input  $x$  and its reconstruction at the output  $\hat{x}$ .

An autoencoder is composed of an encoder and a decoder. The encoder and decoder can have multiple layers, but for simplicity consider that each of them has only one layer.

If the input to an autoencoder is a vector  $x \in \mathbb{R}^{D_x}$ , then the encoder maps the vector  $x$  to another vector  $z \in \mathbb{R}^{D^{(1)}}$  as follows:

$$z = h^{(1)}(W^{(1)}x + b^{(1)}),$$

where the superscript (1) indicates the first layer.  $h^{(1)}: \mathbb{R}^{D^{(1)}} \rightarrow \mathbb{R}^{D^{(1)}}$  is a transfer function for the encoder,  $W^{(1)} \in \mathbb{R}^{D^{(1)} \times D_x}$  is a weight matrix, and  $b^{(1)} \in \mathbb{R}^{D^{(1)}}$  is a bias vector. Then, the decoder maps the encoded representation  $z$  back into an estimate of the original input vector,  $x$ , as follows:

$$\hat{x} = h^{(2)}(W^{(2)}z + b^{(2)}),$$

where the superscript (2) represents the second layer.  $h^{(2)}: \mathbb{R}^{D_x} \rightarrow \mathbb{R}^{D_x}$  is the transfer function for the decoder,  $W^{(2)} \in \mathbb{R}^{D_x \times D^{(1)}}$  is a weight matrix, and  $b^{(2)} \in \mathbb{R}^{D_x}$  is a bias vector.

### Sparse Autoencoders

Encouraging sparsity of an autoencoder is possible by adding a regularizer to the cost function [2]. This regularizer is a function of the average output activation value of a neuron. The average output activation measure of a neuron  $i$  is defined as:

$$\hat{\rho}_i = \frac{1}{n} \sum_{j=1}^n z_i^{(1)}(x_j) = \frac{1}{n} \sum_{j=1}^n h(w_i^{(1)T}x_j + b_i^{(1)}),$$

where  $n$  is the total number of training examples.  $x_j$  is the  $j$ th training example,  $w_i^{(1)T}$  is the  $i$ th row of the weight matrix  $W^{(1)}$ , and  $b_i^{(1)}$  is the  $i$ th entry of the bias vector,  $b^{(1)}$ . A neuron is considered to be ‘firing’, if its output activation value is high. A low output activation value means that the neuron in the hidden layer fires in response to a small number of the training examples. Adding a term to the cost function that constrains the values of  $\hat{\rho}_i$  to be low encourages the autoencoder to learn a representation, where each neuron in the hidden layer fires to a small number of training examples. That is, each neuron specializes by responding to some feature that is only present in a small subset of the training examples.

### Sparsity Regularization

Sparsity regularizer attempts to enforce a constraint on the sparsity of the output from the hidden layer. Sparsity can be encouraged by adding a regularization term that takes a large value when the average activation value,  $\hat{\rho}_i$ , of a neuron  $i$  and its desired value,  $\rho$ , are not close in value [2]. One such sparsity regularization term can be the Kullback-Leibler divergence.

$$\Omega_{sparsity} = \sum_{i=1}^{D^{(1)}} KL(\rho \parallel \hat{\rho}_i) = \sum_{i=1}^{D^{(1)}} \rho \log\left(\frac{\rho}{\hat{\rho}_i}\right) + (1 - \rho) \log\left(\frac{1 - \rho}{1 - \hat{\rho}_i}\right)$$

Kullback-Leibler divergence is a function for measuring how different two distributions are. In this case, it takes the value zero when  $\rho$  and  $\hat{\rho}_i$  are equal to each other, and becomes larger as they diverge from each other. Minimizing the cost function forces this term to be small, hence  $\rho$  and  $\hat{\rho}_i$  to be close to each other. You can define the desired value of the average activation value using the `SparsityProportion` name-value pair argument while training an autoencoder.

### L<sub>2</sub> Regularization

When training a sparse autoencoder, it is possible to make the sparsity regulariser small by increasing the values of the weights  $w^{(1)}$  and decreasing the values of  $z^{(1)}$  [2]. Adding a regularization term on the weights to the cost function prevents it from happening. This term is called the L<sub>2</sub> regularization term and is defined by:

$$\Omega_{weights} = \frac{1}{2} \sum_l^L \sum_j^n \sum_i^k (w_{ji}^{(l)})^2,$$

where  $L$  is the number of hidden layers,  $n$  is the number of observations (examples), and  $k$  is the number of variables in the training data.

### Cost Function

The cost function for training a sparse autoencoder on page 2-484 is an adjusted mean squared error function as follows:

$$E = \underbrace{\frac{1}{N} \sum_{n=1}^N \sum_{k=1}^K (x_{kn} - \hat{x}_{kn})^2}_{\text{mean squared error}} + \lambda * \underbrace{\Omega_{weights}}_{L_2 \text{ regularization}} + \beta * \underbrace{\Omega_{sparsity}}_{\text{sparsity regularization}},$$

where  $\lambda$  is the coefficient for the  $L_2$  regularization term on page 2-484 and  $\beta$  is the coefficient for the sparsity regularization term on page 2-484. You can specify the values of  $\lambda$  and  $\beta$  by using the `L2WeightRegularization` and `SparsityRegularization` name-value pair arguments, respectively, while training an autoencoder.

### References

- [1] Moller, M. F. "A Scaled Conjugate Gradient Algorithm for Fast Supervised Learning", *Neural Networks*, Vol. 6, 1993, pp. 525-533.
- [2] Olshausen, B. A. and D. J. Field. "Sparse Coding with an Overcomplete Basis Set: A Strategy Employed by V1." *Vision Research*, Vol.37, 1997, pp.3311-3325.

### See Also

[Autoencoder](#) | [encode](#) | [stack](#) | [trainSoftmaxLayer](#)

### Topics

"Train Stacked Autoencoders for Image Classification"

### Introduced in R2015b

## trainSoftmaxLayer

Train a softmax layer for classification

### Syntax

```
net = trainSoftmaxLayer(X,T)
net = trainSoftmaxLayer(X,T,Name,Value)
```

### Description

`net = trainSoftmaxLayer(X,T)` trains a softmax layer, `net`, on the input data `X` and the targets `T`.

`net = trainSoftmaxLayer(X,T,Name,Value)` trains a softmax layer, `net`, with additional options specified by one or more of the `Name, Value` pair arguments.

For example, you can specify the loss function.

### Examples

#### Classify Using Softmax Layer

Load the sample data.

```
[X,T] = iris_dataset;
```

`X` is a 4x150 matrix of four attributes of iris flowers: Sepal length, sepal width, petal length, petal width.

`T` is a 3x150 matrix of associated class vectors defining which of the three classes each input is assigned to. Each row corresponds to a dummy variable representing one of the iris species (classes). In each column, a 1 in one of the three rows represents the class that particular sample (observation or example) belongs to. There is a zero in the rows for the other classes that the observation does not belong to.

Train a softmax layer using the sample data.

```
net = trainSoftmaxLayer(X,T);
```

Classify the observations into one of the three classes using the trained softmax layer.

```
Y = net(X);
```

Plot the confusion matrix using the targets and the classifications obtained from the softmax layer.

```
plotconfusion(T,Y);
```

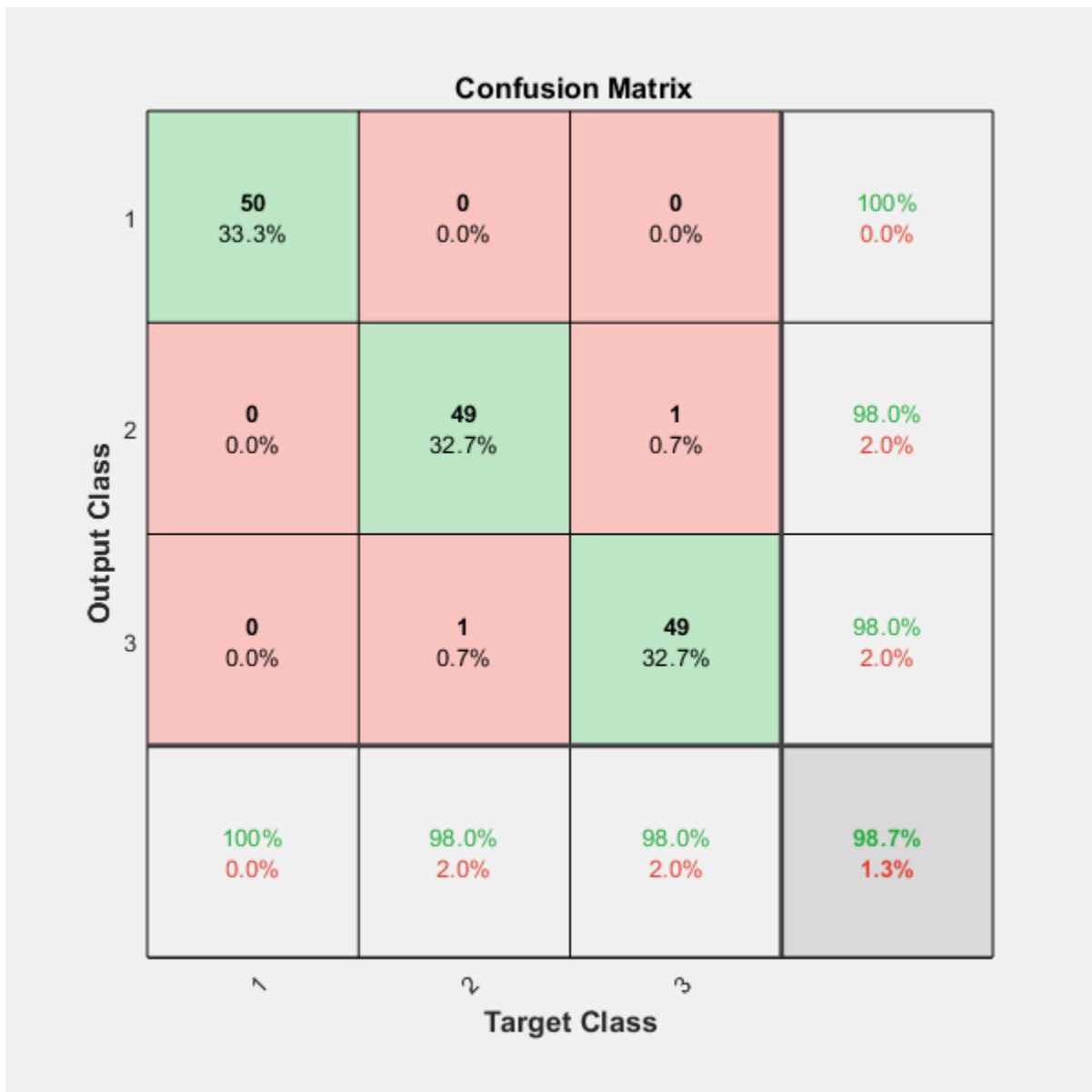

## Input Arguments

### X — Training data

*m*-by-*n* matrix

Training data, specified as an *m*-by-*n* matrix, where *m* is the number of variables in training data, and *n* is the number of observations (examples). Hence, each column of X represents a sample.

Data Types: single | double

### T — Target data

*k*-by-*n* matrix

Target data, specified as a  $k$ -by- $n$  matrix, where  $k$  is the number of classes, and  $n$  is the number of observations. Each row is a dummy variable representing a particular class. In other words, each column represents a sample, and all entries of a column are zero except for a single one in a row. This single entry indicates the class for that sample.

Data Types: `single` | `double`

### Name-Value Pair Arguments

Specify optional comma-separated pairs of `Name`, `Value` arguments. `Name` is the argument name and `Value` is the corresponding value. `Name` must appear inside quotes. You can specify several name and value pair arguments in any order as `Name1`, `Value1`, ..., `NameN`, `ValueN`.

Example: `'MaxEpochs', 400, 'ShowProgressWindow', false` specifies the maximum number of iterations as 400 and hides the training window.

### MaxEpochs — Maximum number of training iterations

1000 (default) | positive integer value

Maximum number of training iterations, specified as the comma-separated pair consisting of `'MaxEpochs'` and a positive integer value.

Example: `'MaxEpochs', 500`

Data Types: `single` | `double`

### LossFunction — Loss function for the softmax layer

`'crossentropy'` (default) | `'mse'`

Loss function for the softmax layer, specified as the comma-separated pair consisting of `'LossFunction'` and either `'crossentropy'` or `'mse'`.

`mse` stands for mean squared error function, which is given by:

$$E = \frac{1}{n} \sum_{j=1}^n \sum_{i=1}^k (t_{ij} - y_{ij})^2,$$

where  $n$  is the number of training examples, and  $k$  is the number of classes.  $t_{ij}$  is the  $ij$ th entry of the target matrix,  $T$ , and  $y_{ij}$  is the  $i$ th output from the autoencoder when the input vector is  $\mathbf{x}_j$ .

The cross entropy function is given by:

$$E = \frac{1}{n} \sum_{j=1}^n \sum_{i=1}^k t_{ij} \ln y_{ij} + (1 - t_{ij}) \ln(1 - y_{ij}).$$

Example: `'LossFunction', 'mse'`

### ShowProgressWindow — Indicator to display the training window

`true` (default) | `false`

Indicator to display the training window during training, specified as the comma-separated pair consisting of `'ShowProgressWindow'` and either `true` or `false`.

Example: `'ShowProgressWindow', false`

Data Types: `logical`



**TrainingAlgorithm — Training algorithm**`'trainscg'` (default)

Training algorithm used to train the softmax layer, specified as the comma-separated pair consisting of `'TrainingAlgorithm'` and `'trainscg'`, which stands for scaled conjugate gradient.

Example: `'TrainingAlgorithm','trainscg'`

**Output Arguments****net — Softmax layer for classification**

network object

Softmax layer for classification, returned as a network object. The softmax layer, `net`, is the same size as the target `T`.

**See Also**`stack` | `trainAutoencoder`**Introduced in R2015b**

## Autoencoder class

Autoencoder class

### Description

An Autoencoder object contains an autoencoder network, which consists of an encoder and a decoder. The encoder maps the input to a hidden representation. The decoder attempts to map this representation back to the original input.

### Construction

`autoenc = trainAutoencoder(X)` returns an autoencoder trained using the training data in `X`.

`autoenc = trainAutoencoder(X,hiddenSize)` returns an autoencoder with the hidden representation size of `hiddenSize`.

`autoenc = trainAutoencoder( ____,Name,Value)` returns an autoencoder for any of the above input arguments with additional options specified by one or more name-value pair arguments.

### Input Arguments

#### **X — Training data**

matrix | cell array of image data

Training data, specified as a matrix of training samples or a cell array of image data. If `X` is a matrix, then each column contains a single sample. If `X` is a cell array of image data, then the data in each cell must have the same number of dimensions. The image data can be pixel intensity data for gray images, in which case, each cell contains an  $m$ -by- $n$  matrix. Alternatively, the image data can be RGB data, in which case, each cell contains an  $m$ -by- $n$ -3 matrix.

Data Types: `single` | `double` | `cell`

#### **hiddenSize — Size of hidden representation of the autoencoder**

10 (default) | positive integer value

Size of hidden representation of the autoencoder, specified as a positive integer value. This number is the number of neurons in the hidden layer.

Data Types: `single` | `double`

### Properties

#### **HiddenSize — Size of the hidden representation**

a positive integer value

Size of the hidden representation in the hidden layer of the autoencoder, stored as a positive integer value.

Data Types: `double`

**EncoderTransferFunction — Name of the transfer function for the encoder**

string

Name of the transfer function for the encoder, stored as a string.

Data Types: char

**EncoderWeights — Weights for the encoder**

matrix

Weights for the encoder, stored as a matrix.

Data Types: double

**EncoderBiases — Bias values for the encoder**

vector

Bias values for the encoder, stored as a vector.

Data Types: double

**DecoderTransferFunction — Name of the transfer function for the decoder**

string

Name of the transfer function for the decoder, stored as a string.

Data Types: char

**DecoderWeights — Weights for the decoder**

matrix

Weights for the decoder, stored as a matrix.

Data Types: double

**DecoderBiases — Bias values for the decoder**

vector

Bias values for the decoder, stored as a vector.

Data Types: double

**TrainingParameters — Parameters that trainAutoencoder uses for training the autoencoder**

structure

Parameters that `trainAutoencoder` uses for training the autoencoder, stored as a structure.

Data Types: struct

**ScaleData — Indicator for data that is rescaled**

true or 1 (default) | false or 0

Indicator for data that is rescaled while passing to the autoencoder, stored as either `true` or `false`.

Autoencoders attempt to replicate their input at their output. For it to be possible, the range of the input data must match the range of the transfer function for the decoder. `trainAutoencoder` automatically scales the training data to this range when training an autoencoder. If the data was

scaled while training an autoencoder, the `predict`, `encode`, and `decode` methods also scale the data.

Data Types: `logical`

### Methods

<code>decode</code>	Decode encoded data
<code>encode</code>	Encode input data
<code>generateFunction</code>	Generate a MATLAB function to run the autoencoder
<code>generateSimulink</code>	Generate a Simulink model for the autoencoder
<code>network</code>	Convert Autoencoder object into network object
<code>plotWeights</code>	Plot a visualization of the weights for the encoder of an autoencoder
<code>predict</code>	Reconstruct the inputs using trained autoencoder
<code>stack</code>	Stack encoders from several autoencoders together
<code>view</code>	View autoencoder

### Copy Semantics

Value. To learn how value classes affect copy operations, see [Copying Objects \(MATLAB\)](#).

### See Also

`trainAutoencoder`

### Topics

[Class Attributes \(MATLAB\)](#)

[Property Attributes \(MATLAB\)](#)

### Introduced in R2015b

# decode

**Class:** Autoencoder

Decode encoded data

## Syntax

```
Y = decode(autoenc,Z)
```

## Description

`Y = decode(autoenc,Z)` returns the decoded data on page 2-494 Y, using the autoencoder autoenc.

## Input Arguments

**autoenc** — Trained autoencoder

Autoencoder object

Trained autoencoder, returned by the `trainAutoencoder` function as an object of the `Autoencoder` class.

**Z** — Data encoded by autoenc

matrix

Data encoded by autoenc, specified as a matrix. Each column of Z represents an encoded sample (observation).

Data Types: `single` | `double`

## Output Arguments

**Y** — Decoded data

matrix | cell array of image data

Decoded data, returned as a matrix or a cell array of image data.

If the autoencoder autoenc was trained on a cell array of image data, then Y is also a cell array of images.

If the autoencoder autoenc was trained on a matrix, then Y is also a matrix, where each column of Y corresponds to one sample or observation.

## Examples

### Decode Encoded Data For New Images

Load the training data.

```
X = digitTrainCellArrayData;
```

X is a 1-by-5000 cell array, where each cell contains a 28-by-28 matrix representing a synthetic image of a handwritten digit.

Train an autoencoder using the training data with a hidden size of 15.

```
hiddenSize = 15;  
autoenc = trainAutoencoder(X,hiddenSize);
```

Extract the encoded data for new images using the autoencoder.

```
Xnew = digitTestCellArrayData;  
features = encode(autoenc,Xnew);
```

Decode the encoded data from the autoencoder.

```
Y = decode(autoenc, features);
```

Y is a 1-by-5000 cell array, where each cell contains a 28-by-28 matrix representing a synthetic image of a handwritten digit.

## Algorithms

If the input to an autoencoder is a vector  $x \in \mathbb{R}^{D_x}$ , then the encoder maps the vector  $x$  to another vector  $z \in \mathbb{R}^{D^{(1)}}$  as follows:

$$z = h^{(1)}(W^{(1)}x + b^{(1)}),$$

where the superscript (1) indicates the first layer.  $h^{(1)}: \mathbb{R}^{D^{(1)}} \rightarrow \mathbb{R}^{D^{(1)}}$  is a transfer function for the encoder,  $W^{(1)} \in \mathbb{R}^{D^{(1)} \times D_x}$  is a weight matrix, and  $b^{(1)} \in \mathbb{R}^{D^{(1)}}$  is a bias vector. Then, the decoder maps the encoded representation  $z$  back into an estimate of the original input vector,  $\hat{x}$ , as follows:

$$\hat{x} = h^{(2)}(W^{(2)}z + b^{(2)}),$$

where the superscript (2) represents the second layer.  $h^{(2)}: \mathbb{R}^{D_x} \rightarrow \mathbb{R}^{D_x}$  is the transfer function for the decoder,  $W^{(2)} \in \mathbb{R}^{D_x \times D^{(1)}}$  is a weight matrix, and  $b^{(2)} \in \mathbb{R}^{D_x}$  is a bias vector.

## See Also

`encode` | `trainAutoencoder`

**Introduced in R2015b**

# encode

**Class:** Autoencoder

Encode input data

## Syntax

```
Z = encode(autoenc,Xnew)
```

## Description

`Z = encode(autoenc,Xnew)` returns the encoded data on page 2-496, `Z`, for the input data `Xnew`, using the autoencoder, `autoenc`.

## Input Arguments

**autoenc — Trained autoencoder**

Autoencoder object

Trained autoencoder, returned as an object of the `Autoencoder` class.

**Xnew — Input data**

matrix | cell array of image data | array of single image data

Input data, specified as a matrix of samples, a cell array of image data, or an array of single image data.

If the autoencoder `autoenc` was trained on a matrix, where each column represents a single sample, then `Xnew` must be a matrix, where each column represents a single sample.

If the autoencoder `autoenc` was trained on a cell array of images, then `Xnew` must either be a cell array of image data or an array of single image data.

Data Types: `single` | `double` | `cell`

## Output Arguments

**Z — Data encoded by autoenc**

matrix

Data encoded by `autoenc`, specified as a matrix. Each column of `Z` represents an encoded sample (observation).

Data Types: `single` | `double`

## Examples

### Encode Decoded Data for New Images

Load the sample data.

```
X = digitTrainCellArrayData;
```

X is a 1-by-5000 cell array, where each cell contains a 28-by-28 matrix representing a synthetic image of a handwritten digit.

Train an autoencoder with a hidden size of 50 using the training data.

```
autoenc = trainAutoencoder(X,50);
```

Encode decoded data for new image data.

```
Xnew = digitTestCellArrayData;  
Z = encode(autoenc,Xnew);
```

Xnew is a 1-by-5000 cell array. Z is a 50-by-5000 matrix, where each column represents the image data of one handwritten digit in the new data Xnew.

### Algorithms

If the input to an autoencoder is a vector  $x \in \mathbb{R}^{D_x}$ , then the encoder maps the vector  $x$  to another vector  $z \in \mathbb{R}^{D^{(1)}}$  as follows:

$$z = h^{(1)}(W^{(1)}x + b^{(1)}),$$

where the superscript (1) indicates the first layer.  $h^{(1)}: \mathbb{R}^{D^{(1)}} \rightarrow \mathbb{R}^{D^{(1)}}$  is a transfer function for the encoder,  $W^{(1)} \in \mathbb{R}^{D^{(1)} \times D_x}$  is a weight matrix, and  $b^{(1)} \in \mathbb{R}^{D^{(1)}}$  is a bias vector.

### See Also

[decode](#) | [stack](#) | [trainAutoencoder](#)

**Introduced in R2015b**



# generateFunction

**Class:** Autoencoder

Generate a MATLAB function to run the autoencoder

## Syntax

```
generateFunction(autoenc)
generateFunction(autoenc,pathname)
generateFunction(autoenc,pathname,Name,Value)
```

## Description

`generateFunction(autoenc)` generates a complete stand-alone function in the current directory, to run the autoencoder `autoenc` on input data.

`generateFunction(autoenc,pathname)` generates a complete stand-alone function to run the autoencoder `autoenc` on input data in the location specified by `pathname`.

`generateFunction(autoenc,pathname,Name,Value)` generates a complete stand-alone function with additional options specified by the `Name,Value` pair argument.

## Input Arguments

### **autoenc — Trained autoencoder**

Autoencoder object

Trained autoencoder, returned as an object of the `Autoencoder` class.

### **pathname — Location for generated function**

string

Location for generated function, specified as a string.

Example: 'C:\MyDocuments\Autoencoders'

Data Types: char

### **Name-Value Pair Arguments**

Specify optional comma-separated pairs of `Name,Value` arguments. `Name` is the argument name and `Value` is the corresponding value. `Name` must appear inside quotes. You can specify several name and value pair arguments in any order as `Name1,Value1,...,NameN,ValueN`.

### **ShowLinks — Indicator to display the links to the generated code**

false (default) | true

Indicator to display the links to the generated code in the command window, specified as the comma-separated pair consisting of 'ShowLinks' and either `true` or `false`.

Example: 'ShowLinks',true

Data Types: `logical`

### Examples

#### Generate MATLAB Function for Running Autoencoder

Load the sample data.

```
X = iris_dataset;
```

Train an autoencoder with 4 neurons in the hidden layer.

```
autoenc = trainAutoencoder(X,4);
```

Generate the code for running the autoencoder. Show the links to the MATLAB function.

```
generateFunction(autoenc)
```

```
MATLAB function generated: neural_function.m  
To view generated function code: edit neural_function  
For examples of using function: help neural_function
```

Generate the code for the autoencoder in a specific path.

```
generateFunction(autoenc, 'H:\Documents\Autoencoder')
```

```
MATLAB function generated: H:\Documents\Autoencoder.m  
To view generated function code: edit Autoencoder  
For examples of using function: help Autoencoder
```

### Tips

- If you do not specify the path and the file name, `generateFunction`, by default, creates the code in an m-file with the name `neural_function.m`. You can change the file name after `generateFunction` generates it. Or you can specify the path and file name using the `pathname` input argument in the call to `generateFunction`.

### See Also

`genFunction` | `generateSimulink`

**Introduced in R2015b**

# generateSimulink

**Class:** Autoencoder

Generate a Simulink model for the autoencoder

## Syntax

```
generateSimulink(autoenc)
```

## Description

`generateSimulink(autoenc)` creates a Simulink model for the autoencoder, `autoenc`.

## Input Arguments

**autoenc — Trained autoencoder**

Autoencoder object

Trained autoencoder, returned as an object of the `Autoencoder` class.

## Examples

### Generate Simulink Model for Autoencoder

Load the training data.

```
X = digitSmall_dataset;
```

The training data is a 1-by-500 cell array, where each cell containing a 28-by-28 matrix representing a synthetic image of a handwritten digit.

Train an autoencoder with a hidden layer containing 25 neurons.

```
hiddenSize = 25;  
autoenc = trainAutoencoder(X,hiddenSize,...  
    'L2WeightRegularization',0.004,...  
    'SparsityRegularization',4,...  
    'SparsityProportion',0.15);
```

Create a Simulink model for the autoencoder, `autoenc`.

```
generateSimulink(autoenc)
```

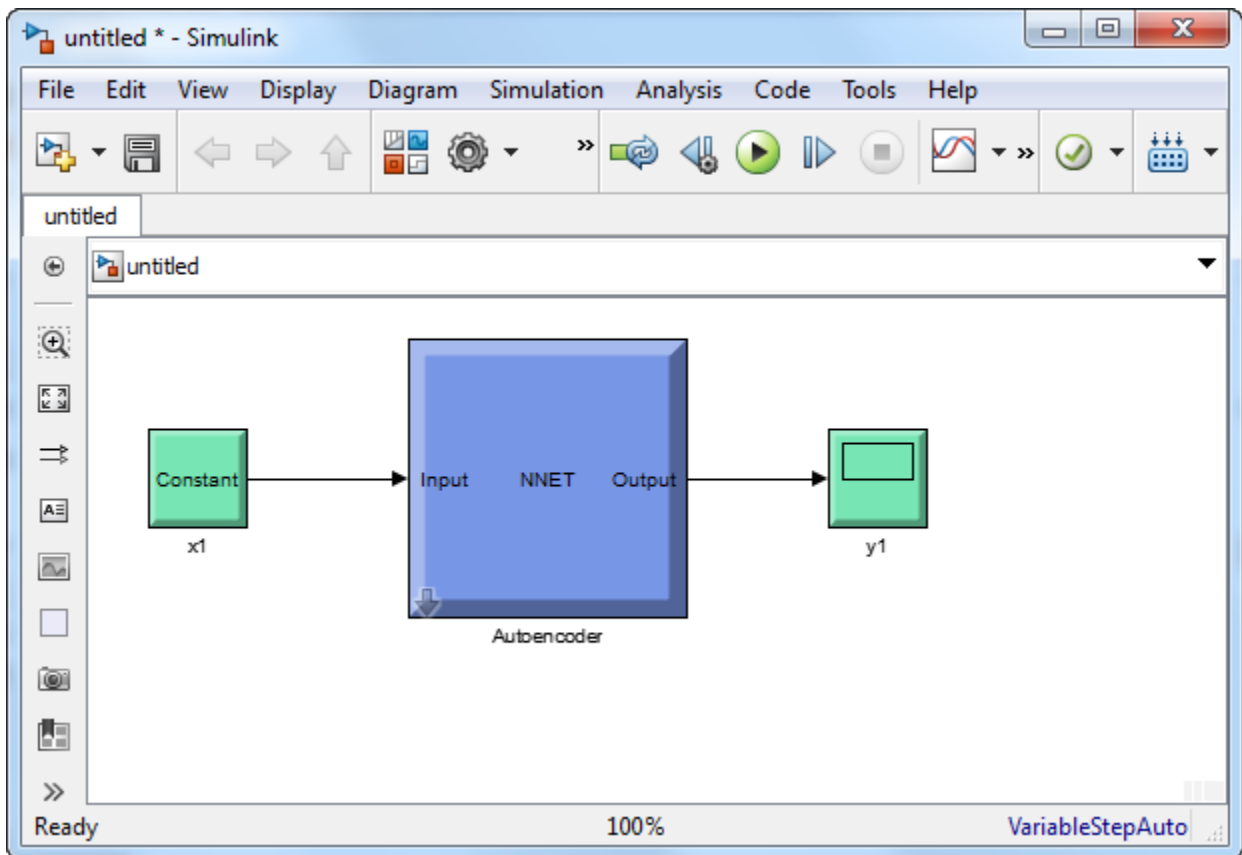

## See Also

`trainAutoencoder`

**Introduced in R2015b**

# network

**Class:** Autoencoder

Convert Autoencoder object into network object

## Syntax

```
net = network(autoenc)
```

## Description

`net = network(autoenc)` returns a network object which is equivalent to the autoencoder, `autoenc`.

## Input Arguments

**autoenc — Trained autoencoder**

Autoencoder object

Trained autoencoder, returned as an object of the `Autoencoder` class.

## Output Arguments

**net — Neural network**

network object

Neural network, that is equivalent to the autoencoder `autoenc`, returned as an object of the `network` class.

## Examples

### Create Network from Autoencoder

Load the sample data.

```
X = bodyfat_dataset;
```

```
X = bodyfat_dataset;
```

`X` is a 13-by-252 matrix defining thirteen attributes of 252 different neighborhoods. For more information on the data, type `help house_dataset` in the command line.

Train an autoencoder on the attribute data.

```
autoenc = trainAutoencoder(X);
```

Create a network object from the autoencoder, `autoenc`.

```
net = network(autoenc);
```

Predict the attributes using the network, net .

```
Xpred = net(X);
```

Fit a linear regression model between the actual and estimated attributes data. Compute the estimated Pearson correlation coefficient, the slope and the intercept (bias) of the regression model, using all attribute data as one data set.

```
[C, S, B] = regression(X, Xpred, 'one')
```

```
C = 0.9996
```

```
S = 0.9982
```

```
B = 0.1195
```

The correlation coefficient is almost 1, which indicates that the attributes data and the estimations from the neural network are highly close to each other.

Plot the actual data and the fitted line.

```
plotregression(X, Xpred);
```

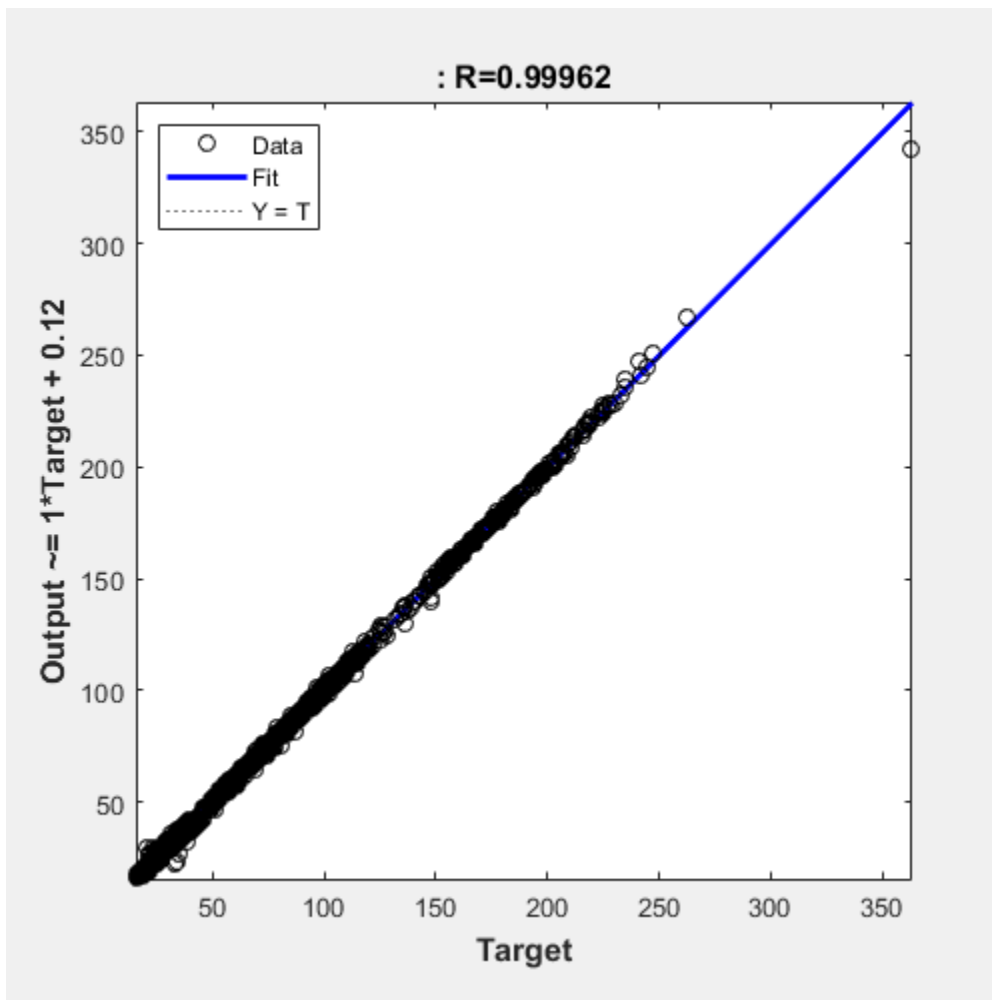

The data appears to be on the fitted line, which visually supports the conclusion that the predictions are very close to the actual data.

**See Also**

Autoencoder | `trainAutoencoder`

**Introduced in R2015b**

## plotWeights

**Class:** Autoencoder

Plot a visualization of the weights for the encoder of an autoencoder

### Syntax

```
plotWeights(autoenc)
h = plotWeights(autoenc)
```

### Description

`plotWeights(autoenc)` visualizes the weights for the autoencoder, `autoenc`.

`h = plotWeights(autoenc)` returns a function handle `h`, for the visualization of the encoder weights for the autoencoder, `autoenc`.

### Input Arguments

**autoenc** — Trained autoencoder

Autoencoder object

Trained autoencoder, returned as an object of the `Autoencoder` class.

### Output Arguments

**h** — Image object

handle

Image object, returned as a handle.

### Examples

#### Visualize Learned Features

Load the training data.

```
X = digitTrainCellArrayData;
```

The training data is a 1-by-5000 cell array, where each cell contains a 28-by-28 matrix representing a synthetic image of a handwritten digit.

Train an autoencoder with a hidden layer of 25 neurons.

```
hiddenSize = 25;
autoenc = trainAutoencoder(X,hiddenSize, ...
    'L2WeightRegularization',0.004, ...
    'SparsityRegularization',4, ...
    'SparsityProportion',0.2);
```



Visualize the learned features.

```
plotWeights(autoenc);
```

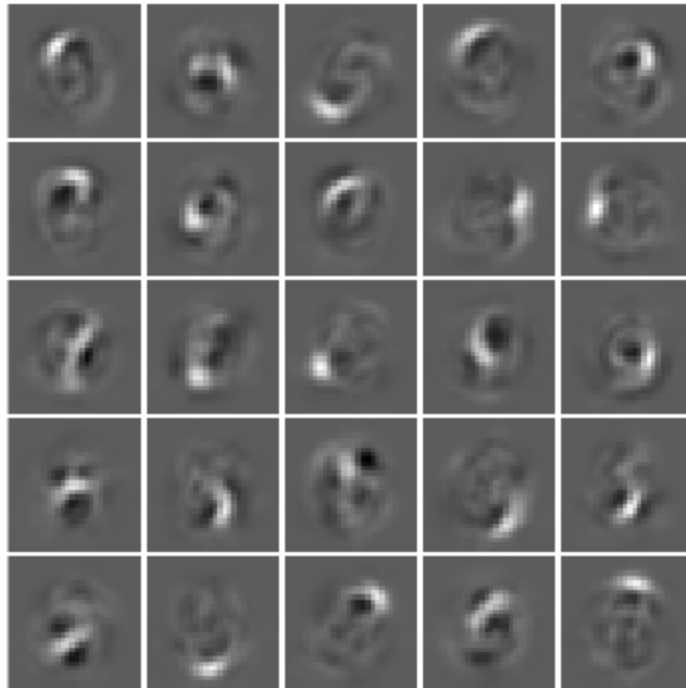

### Tips

- `plotWeights` allows the visualization of the features that the autoencoder learns. Use it when the autoencoder is trained on image data. The visualization of the weights has the same dimensions as the images used for training.

### See Also

`trainAutoencoder`

**Introduced in R2015b**

## predict

**Class:** Autoencoder

Reconstruct the inputs using trained autoencoder

### Syntax

```
Y = predict(autoenc,X)
```

### Description

`Y = predict(autoenc,X)` returns the predictions `Y` for the input data `X`, using the autoencoder `autoenc`. The result `Y` is a reconstruction of `X`.

### Input Arguments

**autoenc — Trained autoencoder**

Autoencoder object

Trained autoencoder, returned as an object of the `Autoencoder` class.

**Xnew — Input data**

matrix | cell array of image data | array of single image data

Input data, specified as a matrix of samples, a cell array of image data, or an array of single image data.

If the autoencoder `autoenc` was trained on a matrix, where each column represents a single sample, then `Xnew` must be a matrix, where each column represents a single sample.

If the autoencoder `autoenc` was trained on a cell array of images, then `Xnew` must either be a cell array of image data or an array of single image data.

Data Types: `single` | `double` | `cell`

### Output Arguments

**Y — Predictions for the input data Xnew**

matrix | cell array of image data | array of single image data

Predictions for the input data `Xnew`, returned as a matrix or a cell array of image data.

- If `Xnew` is a matrix, then `Y` is also a matrix, where each column corresponds to a single sample (observation or example).
- If `Xnew` is a cell array of image data, then `Y` is also a cell array of image data, where each cell contains the data for a single image.
- If `Xnew` is an array of a single image data, then `Y` is also an array of a single image data.

## Examples

### Predict Continuous Measurements Using Trained Autoencoder

Load the training data.

```
X = iris_dataset;
```

The training data contains measurements on four attributes of iris flowers: Sepal length, sepal width, petal length, petal width.

Train an autoencoder on the training data using the positive saturating linear transfer function in the encoder and linear transfer function in the decoder.

```
autoenc = trainAutoencoder(X, 'EncoderTransferFunction', ...  
'satlin', 'DecoderTransferFunction', 'purelin');
```

Reconstruct the measurements using the trained network, autoenc.

```
xReconstructed = predict(autoenc,X);
```

Plot the predicted measurement values along with the actual values in the training dataset.

```
for i = 1:4  
h(i) = subplot(1,4,i);  
plot(X(i,:), 'r. ');  
hold on  
plot(xReconstructed(i,:), 'go');  
hold off;  
end  
title(h(1), {'Sepal'; 'Length'});  
title(h(2), {'Sepal'; 'Width'});  
title(h(3), {'Petal'; 'Length'});  
title(h(4), {'Petal'; 'Width'});
```

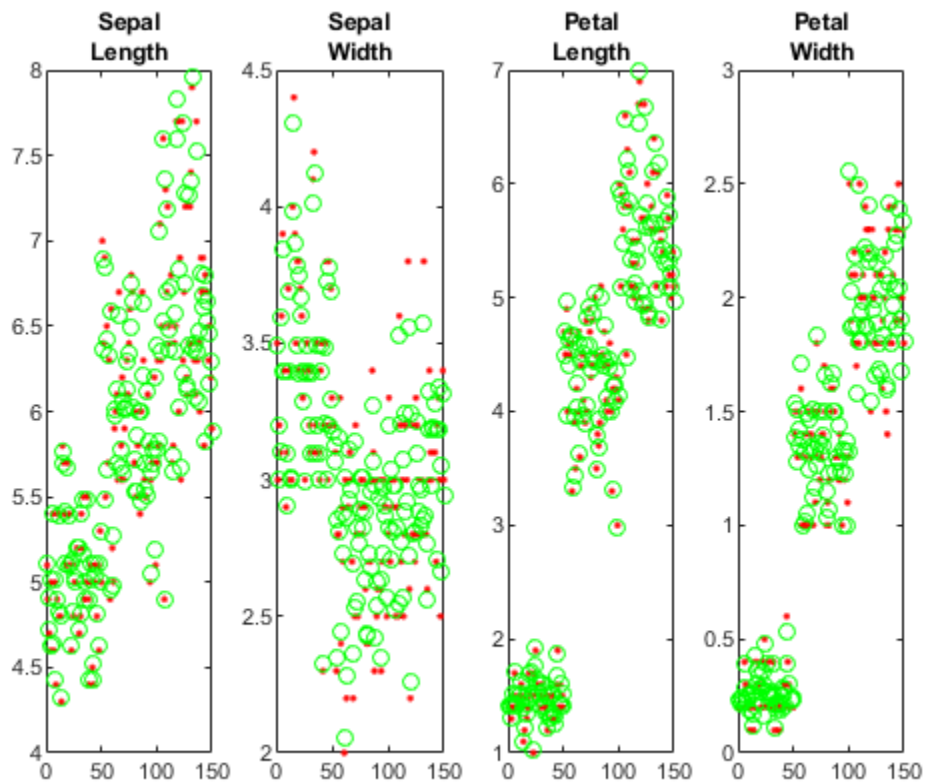

The red dots represent the training data and the green circles represent the reconstructed data.

### Reconstruct Handwritten Digit Images Using Sparse Autoencoder

Load the training data.

```
XTrain = digitTrainCellArrayData;
```

The training data is a 1-by-5000 cell array, where each cell containing a 28-by-28 matrix representing a synthetic image of a handwritten digit.

Train an autoencoder with a hidden layer containing 25 neurons.

```
hiddenSize = 25;
autoenc = trainAutoencoder(XTrain,hiddenSize,...
    'L2WeightRegularization',0.004,...
    'SparsityRegularization',4,...
    'SparsityProportion',0.15);
```

Load the test data.

```
XTest = digitTestCellArrayData;
```

The test data is a 1-by-5000 cell array, with each cell containing a 28-by-28 matrix representing a synthetic image of a handwritten digit.

Reconstruct the test image data using the trained autoencoder, autoenc.

```
xReconstructed = predict(autoenc,XTest);
```

View the actual test data.

```
figure;  
for i = 1:20  
    subplot(4,5,i);  
    imshow(XTest{i});  
end
```

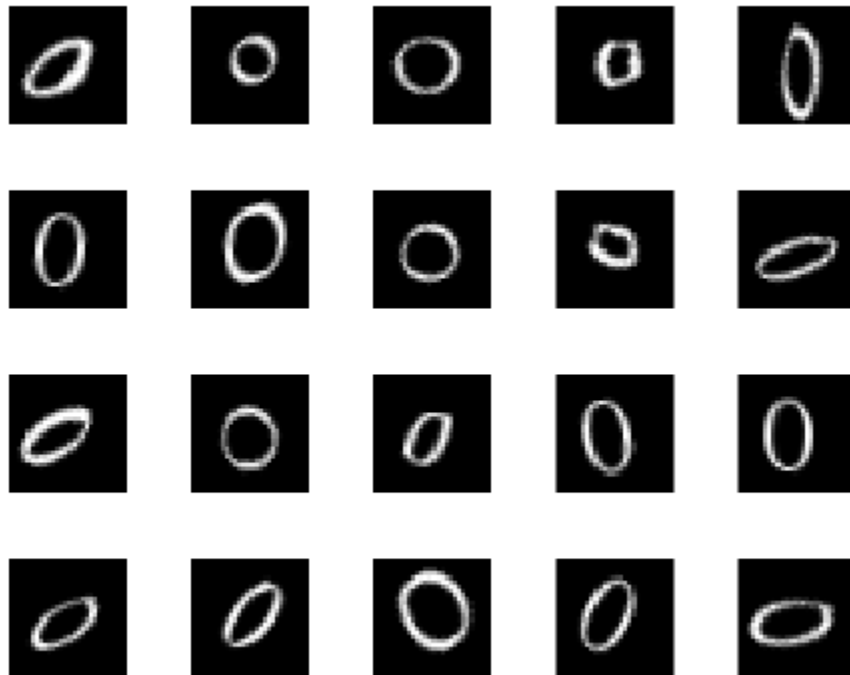

View the reconstructed test data.

```
figure;  
for i = 1:20  
    subplot(4,5,i);  
    imshow(xReconstructed{i});  
end
```

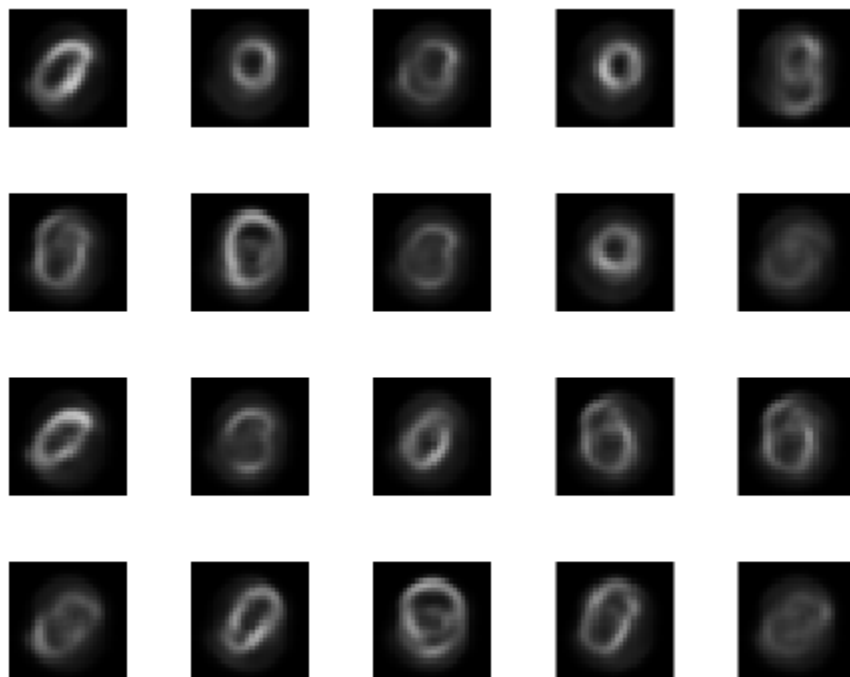

**See Also**

`trainAutoencoder`

**Introduced in R2015b**

# stack

**Class:** Autoencoder

Stack encoders from several autoencoders together

## Syntax

```
stackednet = stack(autoenc1,autoenc2,...)
stackednet = stack(autoenc1,autoenc2,...,net1)
```

## Description

`stackednet = stack(autoenc1,autoenc2,...)` returns a network object created by stacking the encoders of the autoencoders, `autoenc1`, `autoenc2`, and so on.

`stackednet = stack(autoenc1,autoenc2,...,net1)` returns a network object created by stacking the encoders of the autoencoders and the network object `net1`.

The autoencoders and the network object can be stacked only if their dimensions match.

## Input Arguments

### **autoenc1 — Trained autoencoder**

Autoencoder object

Trained autoencoder, specified as an Autoencoder object.

### **autoenc2 — Trained autoencoder**

Autoencoder object

Trained autoencoder, specified as an Autoencoder object.

### **net1 — Trained neural network**

network object

Trained neural network, specified as a network object. `net1` can be a softmax layer, trained using the `trainSoftmaxLayer` function.

## Output Arguments

### **stackednet — Stacked neural network**

network object

Stacked neural network (deep network), returned as a network object

## Examples

### Create a Stacked Network

Load the training data.

```
[X,T] = iris_dataset;
```

Train an autoencoder with a hidden layer of size 5 and a linear transfer function for the decoder. Set the L2 weight regularizer to 0.001, sparsity regularizer to 4 and sparsity proportion to 0.05.

```
hiddenSize = 5;
autoenc = trainAutoencoder(X, hiddenSize, ...
    'L2WeightRegularization', 0.001, ...
    'SparsityRegularization', 4, ...
    'SparsityProportion', 0.05, ...
    'DecoderTransferFunction', 'purelin');
```

Extract the features in the hidden layer.

```
features = encode(autoenc,X);
```

Train a softmax layer for classification using the features .

```
softnet = trainSoftmaxLayer(features,T);
```

Stack the encoder and the softmax layer to form a deep network.

```
stackednet = stack(autoenc,softnet);
```

View the stacked network.

```
view(stackednet);
```

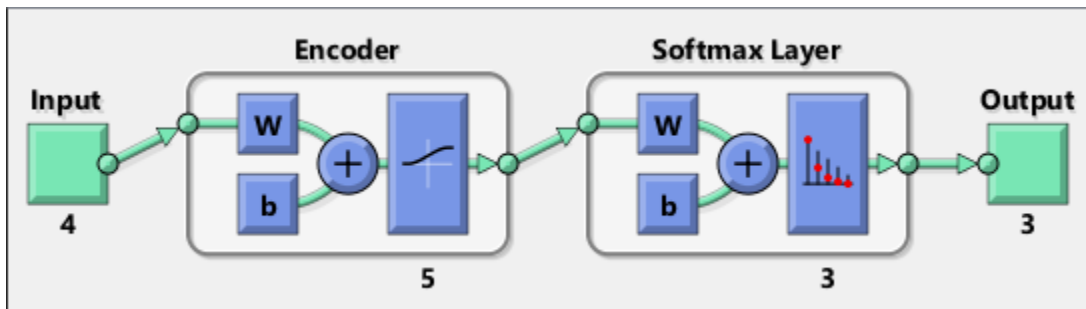

### Tips

- The size of the hidden representation of one autoencoder must match the input size of the next autoencoder or network in the stack.

The first input argument of the stacked network is the input argument of the first autoencoder. The output argument from the encoder of the first autoencoder is the input of the second autoencoder in the stacked network. The output argument from the encoder of the second autoencoder is the input argument to the third autoencoder in the stacked network, and so on.

- The stacked network object `stacknet` inherits its training parameters from the final input argument `net1`.



## **See Also**

Autoencoder | `trainAutoencoder`

## **Topics**

“Train Stacked Autoencoders for Image Classification”

**Introduced in R2015b**

## view

**Class:** Autoencoder

View autoencoder

### Syntax

```
view(autoenc)
```

### Description

`view(autoenc)` returns a diagram of the autoencoder, `autoenc`.

### Input Arguments

**autoenc — Trained autoencoder**

Autoencoder object

Trained autoencoder, returned as an object of the `Autoencoder` class.

### Examples

#### View Autoencoder

Load the training data.

```
X = iris_dataset;
```

Train an autoencoder with a hidden layer of size 5 and a linear transfer function for the decoder. Set the L2 weight regularizer to 0.001, sparsity regularizer to 4 and sparsity proportion to 0.05.

```
hiddenSize = 5;  
autoenc = trainAutoencoder(X, hiddenSize, ...  
    'L2WeightRegularization',0.001, ...  
    'SparsityRegularization',4, ...  
    'SparsityProportion',0.05, ...  
    'DecoderTransferFunction','purelin');
```

View the autoencoder.

```
view(autoenc)
```

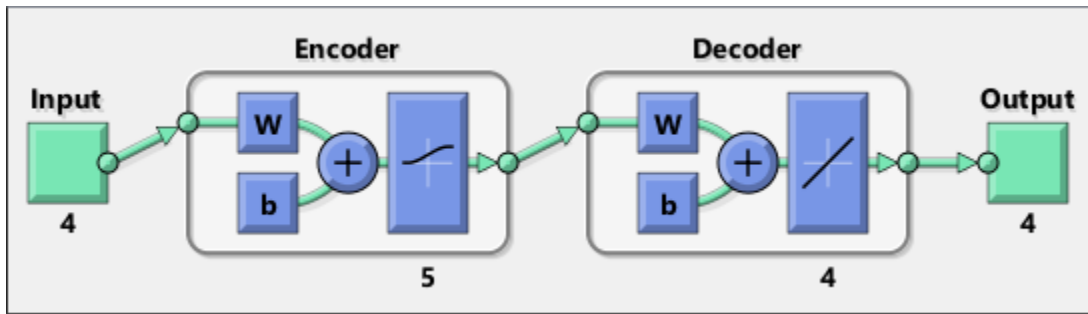

## See Also

`trainAutoencoder`

**Introduced in R2015b**

## fitnet

Function fitting neural network

### Syntax

```
net = fitnet(hiddenSizes)
net = fitnet(hiddenSizes,trainFcn)
```

### Description

`net = fitnet(hiddenSizes)` returns a function fitting neural network with a hidden layer size of `hiddenSizes`.

`net = fitnet(hiddenSizes,trainFcn)` returns a function fitting neural network with a hidden layer size of `hiddenSizes` and training function, specified by `trainFcn`.

### Examples

#### Construct and Train a Function Fitting Network

Load the training data.

```
[x,t] = simplefit_dataset;
```

The 1-by-94 matrix `x` contains the input values and the 1-by-94 matrix `t` contains the associated target output values.

Construct a function fitting neural network with one hidden layer of size 10.

```
net = fitnet(10);
```

View the network.

```
view(net)
```

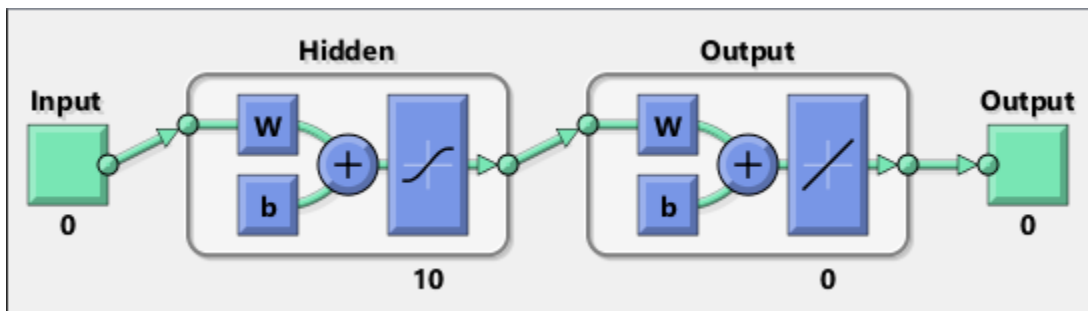

The sizes of the input and output are zero. The software adjusts the sizes of these during training according to the training data.

Train the network `net` using the training data.

```
net = train(net,x,t);
```

View the trained network.

```
view(net)
```

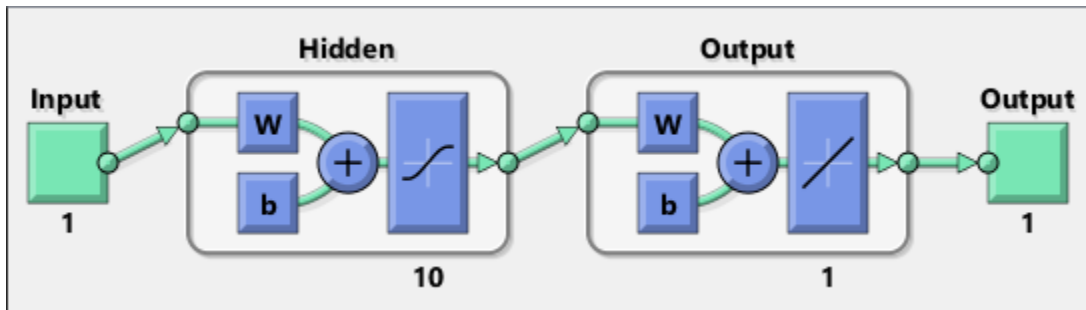

You can see that the sizes of the input and output are 1.

Estimate the targets using the trained network.

```
y = net(x);
```

Assess the performance of the trained network. The default performance function is mean squared error.

```
perf = perform(net,y,t)
```

```
perf =
```

```
1.4639e-04
```

The default training algorithm for a function fitting network is Levenberg-Marquardt ('trainlm'). Use the Bayesian regularization training algorithm and compare the performance results.

```
net = fitnet(10,'trainbr');
net = train(net,x,t);
y = net(x);
perf = perform(net,y,t)
```

```
perf =
```

```
3.3261e-10
```

The Bayesian regularization training algorithm improves the performance of the network in terms of estimating the target values.

## Input Arguments

### hiddenSizes — Size of the hidden layers

10 (default) | row vector

Size of the hidden layers in the network, specified as a row vector. The length of the vector determines the number of hidden layers in the network.

Example: For example, you can specify a network with 3 hidden layers, where the first hidden layer size is 10, the second is 8, and the third is 5 as follows: [10,8,5]

The input and output sizes are set to zero. The software adjusts the sizes of these during training according to the training data.

Data Types: single | double

**trainFcn — Training function name**

'trainlm' (default) | 'trainbr' | 'trainbfg' | 'trainrp' | 'trainscg' | ...

Training function name, specified as one of the following.

Training Function	Algorithm
'trainlm'	Levenberg-Marquardt
'trainbr'	Bayesian Regularization
'trainbfg'	BFGS Quasi-Newton
'trainrp'	Resilient Backpropagation
'trainscg'	Scaled Conjugate Gradient
'traincgb'	Conjugate Gradient with Powell/Beale Restarts
'traincgf'	Fletcher-Powell Conjugate Gradient
'traincgp'	Polak-Ribière Conjugate Gradient
'trainoss'	One Step Secant
'traingdx'	Variable Learning Rate Gradient Descent
'traingdm'	Gradient Descent with Momentum
'traingd'	Gradient Descent

Example: For example, you can specify the variable learning rate gradient descent algorithm as the training algorithm as follows: 'traingdx'

For more information on the training functions, see “Train and Apply Multilayer Shallow Neural Networks” and “Choose a Multilayer Neural Network Training Function”.

Data Types: char

**Output Arguments**

**net — Function fitting network**

network object

Function fitting network, returned as a network object.

**Tips**

- Function fitting is the process of training a neural network on a set of inputs in order to produce an associated set of target outputs. After you construct the network with the desired hidden layers

and the training algorithm, you must train it using a set of training data. Once the neural network has fit the data, it forms a generalization of the input-output relationship. You can then use the trained network to generate outputs for inputs it was not trained on.

## **See Also**

`feedforwardnet` | `network` | `nftool` | `perform` | `train` | `trainlm`

## **Topics**

“Fit Data with a Shallow Neural Network”

“Neural Network Object Properties”

“Neural Network Subobject Properties”

## **Introduced in R2010b**

